



## A Methodology for Solving 3D Matrix Games with Triangular Intuitionistic Fuzzy Payoffs and it's Application

G.Sasikala<sup>1\*</sup> and S.A.Sahathana Thasneem<sup>2\*</sup>

<sup>1</sup>Associate Professor, Department of Mathematics, Chikkanna Government Arts College, Tiruppur, (Affiliated to Bharathiar University, Coimbatore), Tamil Nadu, India.

<sup>2</sup>Research Scholar, Department of Mathematics, Chikkanna Government Arts College, Tiruppur, (Affiliated to Bharathiar University, Coimbatore), Tamil Nadu, India.

Received: 22 Jan 2024

Revised: 09 Feb 2024

Accepted: 29 Apr 2024

### \*Address for Correspondence

**G.Sasikala**

Associate Professor,  
Department of Mathematics,  
Chikkanna Government Arts College, Tiruppur,  
(Affiliated to Bharathiar University, Coimbatore),  
Tamil Nadu, India.  
Email: sasiganesh2306@gmail.com



This is an Open Access Journal / article distributed under the terms of the **Creative Commons Attribution License** (CC BY-NC-ND 3.0) which permits unrestricted use, distribution, and reproduction in any medium, provided the original work is properly cited. All rights reserved.

### ABSTRACT

The decision criteria for three dimensional matrix games with Triangular Intuitionistic fuzzy (TIF) payoff values are presented in this study. Using an enhanced ranking algorithm, the payoff matrix with TIF payoffs is transformed into a crisp payoff matrix. The transformed matrix is solved by Laplace, Wald, Hurwicz and Savage criteria which are also improved for TIF numbers. Lastly the suggested approach is applied in the agriculture sector.

**Keywords:** Intuitionistic fuzzy set, Triangular Intuitionistic fuzzy number (TIFN), 3D payoff matrix, Decision criteria.

### INTRODUCTION

The decision maker requires to make the finest choice in the decision making situation which entails choosing an appropriate course of action or strategies, gathering information related to the problem and forming a model with respect to the payoffs and states of nature [7]. In literature the decision under uncertainty are solved by the criteria of Laplace [11], Wald, Hurwicz [5], and Savage [16] which are discussed along with its characteristic axioms in [13]. In general the payoff matrix is summarized in a two dimensional matrix with rows and columns contains the payoffs regarding the course of action versus states of nature [15]. Özkaya [14] established the decision criteria in three dimensional matrix which are useful in developing the higher level models. The definitions and operations of 3D





**Sasikala and Sahathana Thasneem**

matrices are given in[6]. In real life situations there are many factors affects the decision making such as lack of information, vagueness , previous history of the process and knowledge about the other players in the game etc, which cannot be expressed precisely in crisp form. Fuzzy set theory introduced by Zadeh[10] is used to overcome such complexities. Membership function of a fuzzy set represents the belongingness of the elements[4]. While dealing with decision theory there arises the concept of acceptance as well as hesitance which are represented by the membership and non-membership functions in Atanassov’s[9] Intuitionistic fuzzy sets. Matrix games with Triangular Intuitionistic fuzzy numbers as payoff values are solved in[17]. Thus far many ranking methods are used to solve or convert the Triangular Intuitionistic fuzzy number payoff values into crisp payoff matrix to make the process less complicated and lucid[1][3]. In this paper a new ranking method is suggested to get the values more specific than the previously used methods. The 3D matrix game with TIF payoffs is converted into the crisp payoff matrix with the aid of the proposed ranking method and solved by the criteria of Laplace, Wald, Hurwicz and Savage which are also improved in this study for TIFN through arithmetic operations of TIFN and Multi Attribute Decision making(MADM) techniques[2]. The ranking method recommended in this research is applied on the example in agriculture to find out the type of the crop to sow in the field in the mean time considering the level of rainfall and other varieties of the crops by the farmer. The paper is organized as follows, In section 2 the definitions and arithmetic operations of TIFN are specified, section 3 covers the refined ranking method, definition of 3D payoff matrix and the decision criteria for TIFN is defined in section 4, In section 5 the illustration of the proposed model is given and section 6 concludes the paper.

**PRELIMINARIES**

**Definition 2.1**

Let  $X = \{x_1, x_2, \dots, x_n\}$  be a finite universal set. An intuitionistic fuzzy set  $\tilde{B}$  in a given universal set  $\square$  is of the form[9],

$$\tilde{B} = \{(x_i, \mu_{\tilde{B}}(x_i), \nu_{\tilde{B}}(x_i)): x_i \in X\},$$

where the functions  $\mu_{\tilde{B}}(x_i), \nu_{\tilde{B}}(x_i)$  are the degree of membership and degree of non - membership of an element  $x_i \in X$ , and they satisfy the condition  $0 \leq \mu_{\tilde{B}}(x_i) + \nu_{\tilde{B}}(x_i) \leq 1, \forall x_i \in X, i = 1,2,3, \dots$

**Definition 2.2**

A Triangular Intuitionistic Fuzzy Number (TIFN) is defined as  $\tilde{l} = ((\underline{l}, \ell, \bar{l}); w_{\tilde{l}}, u_{\tilde{l}})$  in  $\mathbb{R}$  with membership function  $\mu_{\tilde{l}}(x)$  and non-membership function  $\nu_{\tilde{l}}(x)$  which are defined as [9],

$$\mu_{\tilde{l}}(x) = \begin{cases} \frac{x - \underline{l}}{\ell - \underline{l}} w_{\tilde{l}}, & \underline{l} \leq x < \ell \\ w_{\tilde{l}}, & x = \ell \\ \frac{\bar{l} - x}{\bar{l} - \ell} w_{\tilde{l}}, & \ell < x \leq \bar{l} \\ 0, & x < \underline{l} \text{ or } x > \bar{l} \end{cases}$$

and

$$\nu_{\tilde{l}}(x) = \begin{cases} \frac{(\underline{l} - x) + u_{\tilde{l}}(x - \underline{l})}{(\ell - \underline{l})}, & \underline{l} \leq x < \ell \\ u_{\tilde{l}}, & x = \ell \\ \frac{(x - \ell) + u_{\tilde{l}}(\bar{l} - x)}{(\bar{l} - \ell)}, & \ell < x \leq \bar{l} \\ 1, & x < \underline{l} \text{ or } x > \bar{l} \end{cases}$$

The values  $w_{\tilde{l}}, u_{\tilde{l}}$  represents the maximum degree of membership and minimum degree of non-membership, respectively. And they satisfy the condition  $0 \leq w_{\tilde{l}} \leq 1, 0 \leq u_{\tilde{l}} \leq 1$  and  $0 \leq w_{\tilde{l}} + u_{\tilde{l}} \leq 1$ .





**Sasikala and Sahathana Thasneem**

**Definition2.3**

For a TIFN  $\tilde{l} = \langle \underline{l}, \ell, \bar{l}; w_l, u_l \rangle$  the  $(\alpha, \beta)$ - cut set is a subset of R that is  $\tilde{l}_{\alpha, \beta} = \{x: \mu_i(x) \geq \alpha, \nu_i(x) \leq \beta\}$ , where  $0 \leq \alpha \leq w_l, u_l \leq \beta \leq 1$  and  $0 \leq \alpha + \beta \leq 1$ . and  $\tilde{l}_\alpha$  is defined by the closed interval  $[L_i(\alpha), R_i(\alpha)]$ ,

$$L_i(\alpha) = \frac{(w_l - \alpha)\underline{l} + \alpha \ell}{w_l}, \quad R_i(\alpha) = \frac{(w_l - \alpha)\bar{l} + \alpha \ell}{w_l}$$

Then,

$$\tilde{l}_\alpha = \left[ \frac{(w_l - \alpha)\underline{l} + \alpha \ell}{w_l}, \frac{(w_l - \alpha)\bar{l} + \alpha \ell}{w_l} \right]$$

Similarly the  $\beta$  –cut is defined as

$$\tilde{l}_\beta = \left[ \frac{(1 - \beta)\ell + (\beta - u_l)\underline{l}}{1 - u_l}, \frac{(1 - \beta)\ell + (\beta - u_l)\bar{l}}{1 - u_l} \right]$$

**Arithmetic operations on TIFN**

For two TIFNs  $\tilde{l} = \langle \underline{l}, \ell, \bar{l}; w_l, u_l \rangle$  and  $\tilde{f} = \langle \underline{f}, \phi, \bar{f}; w_f, u_f \rangle$  the arithmetic operations are of the form,

$$\tilde{l} + \tilde{f} = \langle \underline{l} + \underline{f}, \ell + \phi, \bar{l} + \bar{f}; w_l \wedge w_f, u_l \vee u_f \rangle$$

$$\tilde{l} - \tilde{f} = \langle \underline{l} - \bar{f}, \ell - \phi, \bar{l} - \underline{f}; w_l \wedge w_f, u_l \vee u_f \rangle$$

$$\tilde{l} \times \tilde{f} = \begin{cases} \langle \underline{l}\underline{f}, \ell\phi, \bar{l}\bar{f} \rangle; w_l \wedge w_f, u_l \vee u_f & \text{if } \tilde{l} > 0 \text{ and } \tilde{f} > 0 \\ \langle \underline{l}\bar{f}, \ell\phi, \bar{l}\underline{f} \rangle; w_l \wedge w_f, u_l \vee u_f & \text{if } \tilde{l} < 0 \text{ and } \tilde{f} > 0 \\ \langle \underline{l}\underline{f}, \ell\phi, \bar{l}\underline{f} \rangle; w_l \wedge w_f, u_l \vee u_f & \text{if } \tilde{l} < 0 \text{ and } \tilde{f} < 0 \end{cases}$$

$$\frac{\tilde{l}}{\tilde{f}} = \begin{cases} \langle \underline{l}/\bar{f}, \ell/\phi, \bar{l}/\underline{f} \rangle; w_l \wedge w_f, u_l \vee u_f & \text{if } \tilde{l} > 0 \text{ and } \tilde{f} > 0 \\ \langle \underline{l}/\bar{f}, \ell/\phi, \bar{l}/\underline{f} \rangle; w_l \wedge w_f, u_l \vee u_f & \text{if } \tilde{l} < 0 \text{ and } \tilde{f} > 0 \\ \langle \underline{l}/\underline{f}, \ell/\phi, \bar{l}/\bar{f} \rangle; w_l \wedge w_f, u_l \vee u_f & \text{if } \tilde{l} < 0 \text{ and } \tilde{f} < 0 \end{cases}$$

For any real number  $\lambda$ ,

$$\lambda \tilde{l} = \begin{cases} \langle (\lambda \underline{l}, \lambda \ell, \lambda \bar{l}); w_l, u_l \rangle, & \text{if } \lambda > 0 \\ \langle (\lambda \bar{l}, \lambda \phi, \lambda \underline{l}); w_l, u_l \rangle, & \text{if } \lambda < 0 \end{cases}$$

**Value and Ambiguity of TIFN**

For the TIFN  $\tilde{l} = \langle \underline{l}, \ell, \bar{l}; w_l, u_l \rangle$  the value of membership and non-membership functions is denoted as  $C_\mu(\tilde{l})$  and  $C_\nu(\tilde{l})$ ,

$$f(\alpha) = \frac{\alpha}{2w_l}, g(\beta) = \frac{1 - \beta}{2(1 - u_l)}$$

Where  $f(\alpha), \alpha \in [0, w_l]$  and  $g(\beta), \beta \in [u_l, 1]$  are the weight functions, the values of  $f$  and  $g$  can be chosen according to the real life situations and satisfy the following conditions

- i.  $f(\alpha) \in [0, 1]$ , and  $g(\beta) \in [0, 1]$
- ii.  $f(0) = 0$  and  $g(1) = 1$
- iii.  $f(\alpha)$  is monotonic and non decreasing for  $\alpha \in [0, w_l]$  and  $g(\beta)$  is monotonic and non increasing for  $\beta \in [u_l, 1]$ .

$$C_\mu(\tilde{l}) = \int_0^{w_l} \left[ \frac{(w_l - \alpha)\underline{l} + \alpha \ell + (w_l - \alpha)\bar{l} + \alpha \ell}{w_l} \right] \left( \frac{\alpha}{2w_l} \right) d\alpha$$

$$= \frac{w_l(\underline{l} + \bar{l} + 4\ell)}{12}$$

$$C_\nu(\tilde{l}) = \int_{u_l}^1 \left[ \frac{(1 - \beta)\ell + (\beta - u_l)\underline{l} + (1 - \beta)\ell + (\beta - u_l)\bar{l}}{1 - u_l} \right] \left( \frac{1 - \beta}{2(1 - u_l)} \right) d\beta$$

$$= \int_{u_l}^1 \left[ \underline{l} + \bar{l} + \frac{(2\ell - \underline{l} - \bar{l})(1 - \beta)}{1 - u_l} \right] \left( \frac{1 - \beta}{2(1 - u_l)} \right) d\beta$$





**Sasikala and Sahathana Thasneem**

$$= \frac{(\underline{l} + 4\ell + \bar{l})(1 - u_I)}{12}$$

The ambiguity of the TIFN  $\tilde{l} = \langle (\underline{l}, \ell, \bar{l}); w_I, u_I \rangle$  are denoted as  $D_\mu(\tilde{l})$  and  $D_v(\tilde{l})$ , defined as

$$\begin{aligned} D_\mu(\tilde{l}) &= \int_0^{w_I} \left[ \frac{(w_I - \alpha)\bar{l} + \alpha\ell - (w_I - \alpha)\underline{l} + \alpha\ell}{w_I} \right] \left( \frac{\alpha}{2w_I} \right) d\alpha \\ &= \int_0^{w_I} \left[ (\bar{l} - \underline{l}) - \frac{(\bar{l} - \underline{l})\alpha}{w_I} \right] \left( \frac{\alpha}{2w_I} \right) d\alpha \\ &= \frac{(\bar{l} - \underline{l})w_I}{12} \\ D_v(\tilde{l}) &= \int_{u_I}^1 \left[ \frac{(1 - \beta)\ell + (\beta - u_I)\bar{l} - (1 - \beta)\ell + (\beta - u_I)\underline{l}}{1 - u_I} \right] \left( \frac{1 - \beta}{2(1 - u_I)} \right) d\beta \\ &= \int_{u_I}^1 \left[ (\bar{l} - \underline{l}) - \frac{(\bar{l} - \underline{l})(1 - \beta)}{1 - u_I} \right] \left( \frac{1 - \beta}{2(1 - u_I)} \right) d\beta \\ &= \frac{(\bar{l} - \underline{l})(1 - u_I)}{12} \end{aligned}$$

**Ranking method**

Different ranking methods used so far to rank the Intuitionistic fuzzy payoff values directly or converting it into crisp payoff in game theory. The score function [17] employed the hesitancy degree  $\pi_I(x) = 1 - \mu_I(x) - \nu_I(x)$ ,  $x \in X$  where  $X$  is the universal set. For an IFN  $\tilde{l}$ ,

$$F(\tilde{l}) = \frac{C_v(\tilde{l}) - C_\mu(\tilde{l})}{\pi(\tilde{l})}$$

This method unfitting if sum of the degrees of membership and non-membership is equal to 1. As the robust ranking method[1] deals with the membership function

$$R(\tilde{l}) = \int_{\alpha=0}^1 \left( \frac{\sqrt{3}}{3} \right) \times (\tilde{l}_\alpha^L + \tilde{l}_\alpha^U) d\alpha$$

Where  $[\tilde{l}_\alpha^L, \tilde{l}_\alpha^U]$  is the  $\alpha$ -cut of the IFN  $\tilde{l}$ , which is not to be utilized in situations needs non- membership along with the membership function. Other ranking methods considering IF numbers [2][8] do not involve the degrees of belongingness and non-belongingness which is a significant tool in analysing the behaviour of the players in real life circumstances. The ranking method used here evaluate the relation between values and ambiguities of membership and non-membership functions of Triangular Intuitionistic fuzzy numbers defined as,

$$\mathcal{R}(\tilde{l}) = \frac{\mathbb{P}(\tilde{l}) + \mathbb{Q}(\tilde{l})}{2} \quad (1)$$

Where,

$$\begin{aligned} \mathbb{P}(\tilde{l}) &= C_\mu(\tilde{l}) + C_v(\tilde{l}) = \frac{(\underline{l} + 4\ell + \bar{l})(w_I + 1 - u_I)}{12}, \\ \mathbb{Q}(\tilde{l}) &= D_\mu(\tilde{l}) + D_v(\tilde{l}) = \frac{(\bar{l} - \underline{l})(w_I + 1 - u_I)}{12} \end{aligned}$$

**Three Dimensional Payoff Matrix**

**Definition4.1 :**

A three dimensional payoff matrix with Triangular Intuitionistic fuzzy payoffs is denoted as  $\tilde{l}_{ij}^k \in \mathcal{R}^{m \times n \times s}$  for  $i = 1, 2, \dots, m; j = 1, 2, \dots, n$  and  $k = 1, 2, \dots, s$ . [14] Where  $i$  indicates the number of rows,  $j$  the number of columns and  $k$  represents the page which is the third dimension of the matrix.

The general form of the three dimensional payoff matrix with  $\tilde{l} = \langle (\underline{l}, \ell, \bar{l}); w_I, u_I \rangle$  as payoffs is of the form  $(\tilde{l}_{ij}^k)$  is denoted as  $\tilde{L}$





**Sasikala and Sahathana Thasneem**

$$\tilde{L} = \left[ \begin{array}{c} \tilde{L}^1 = \begin{bmatrix} \tilde{l}_{11}^1 & \tilde{l}_{12}^1 & \dots & \tilde{l}_{1n}^1 \\ \tilde{l}_{21}^1 & \tilde{l}_{22}^1 & \dots & \tilde{l}_{2n}^1 \\ \vdots & \vdots & \ddots & \vdots \\ \tilde{l}_{m1}^1 & \tilde{l}_{m2}^1 & \dots & \tilde{l}_{mn}^1 \end{bmatrix}, \tilde{L}^2 = \begin{bmatrix} \tilde{l}_{11}^2 & \tilde{l}_{12}^2 & \dots & \tilde{l}_{1n}^2 \\ \tilde{l}_{21}^2 & \tilde{l}_{22}^2 & \dots & \tilde{l}_{2n}^2 \\ \vdots & \vdots & \ddots & \vdots \\ \tilde{l}_{m1}^2 & \tilde{l}_{m2}^2 & \dots & \tilde{l}_{mn}^2 \end{bmatrix}, \dots, \\ \tilde{L}^k = \begin{bmatrix} \tilde{l}_{11}^k & \tilde{l}_{12}^k & \dots & \tilde{l}_{1n}^k \\ \tilde{l}_{21}^k & \tilde{l}_{22}^k & \dots & \tilde{l}_{2n}^k \\ \vdots & \vdots & \ddots & \vdots \\ \tilde{l}_{m1}^k & \tilde{l}_{m2}^k & \dots & \tilde{l}_{mn}^k \end{bmatrix} \end{array} \right]$$

**Decision under uncertainty in three Dimensional form**

The theory of uncertainty is to reveal the association between the actions and the state of nature which result in the outcome in a decision making situation. The basic concept of these relation is given in the table below[13]

Actions	Values	State of Nature				
		$S_1$	$S_2$	$S_3$	...	$S_n$
$A_1$		$v_{11}$	$v_{12}$	$v_{13}$	...	$v_{1n}$
$A_2$		$v_{21}$	$v_{22}$	$v_{23}$	...	$v_{2n}$
$\vdots$		$\vdots$	$\vdots$	$\vdots$	...	$\vdots$
$A_m$		$v_{m1}$	$v_{m2}$	$v_{m3}$	...	$v_{mn}$

The three types of uncertainty are [15]

Type 1: The players are unaware of the states of nature

Type 2: The players have the knowledge about the states of nature but not the probabilities

Type 3: The players are aware of both states of nature and probabilities.

The decision making criteria by laplace, wald, Hurwicz and savage [] are used to deal with these types of uncertainties[] and have the compatibility with the characteristic axioms such as ordering, symmetry, continuity , row/ column adjunction[]. The decision criteria for three dimensional matrix and it's compatibility are given in[]. Improvised form of these criteria are discussed in this section.

**Laplace Criterion**

For a three dimensional matrix  $\tilde{L} \in R^{m \times n \times s}$  with entries  $\tilde{v}_{ij}^k$ , the laplace criterion is defined as[14]

$$\tilde{E}_i^k = \sum_{j=1}^n p_{ij}^k \tilde{v}_{ij}^k$$

Where  $\tilde{E}_i^k$  is the expected monetary value and  $p_{ij}^k$ , and

$$\tilde{r}_i = \frac{1}{n} \sum_{j=1}^n \tilde{v}_{ij}^k$$

if the values of  $\tilde{v}_{ij}^k$  are extended as Multi Attribute decision making problem for Triangular Intuitionistic fuzzy numbers

$$\tilde{r}_i = \left( \left( \frac{1}{n} \right) \sum_{k=1}^s \sum_{j=1}^n \frac{\underline{l}_{ij}^k}{\bar{l}_j^*}, \left( \frac{1}{n} \right) \sum_{k=1}^s \sum_{j=1}^n \frac{p_{ij}^k}{\bar{l}_j^*}, \left( \frac{1}{n} \right) \sum_{k=1}^s \sum_{j=1}^n \frac{\bar{l}_{ij}^k}{\bar{l}_j^*} \right); \min_{1 \leq j \leq n} \{w_{ij}^k\}, \max_{1 \leq j \leq n} \{u_{ij}^k\} \} \tag{2}$$

Where  $\bar{l}_j^*$  is the maximum  $\bar{l}_j$  value in the matrix.

$$\tilde{L}_{opt} = \max_{i=1,2,\dots,m} \{\tilde{r}_i\} \tag{3}$$

$\tilde{r}_i$  is the row block of the three dimensional matrix.

**Wald Criterion**

The waldminmax[14] criterion is used in finding the minimum safety for the decision maker among the worst possible results then maximize the minimum safety level.  $\tilde{w}_i$  is the security level of the actions.





**Sasikala and Sahathana Thasneem**

$$\begin{aligned} \tilde{W}_i^k &= \min_j \{ \tilde{v}_{ij}^k \} \\ &= \min_j \left\langle \left( \frac{l_{ij}^k}{l_j^*}, \frac{t_{ij}^k}{l_j^*}, \frac{\bar{l}_{ij}^k}{l_j^*} \right); w_{T_{ij}^k}, u_{T_{ij}^k} \right\rangle \\ &= \min_j \{ t_{ij}^k \} \end{aligned} \tag{4}$$

Where  $t_{ij}^k$  is the crisp payoff matrix in three dimensional form made by using the ranking method(1)

$$\begin{aligned} \tilde{W}_i &= \min_i \{ \tilde{W}_i^k \} \\ \tilde{W}_{opt} &= \max_i \{ \tilde{W}_i \} \end{aligned} \tag{5}$$

**Hurwicz Criterion**

The Hurwicz maximax[14] criterion is to find the best possible outcome for the decision maker.

$$\begin{aligned} \tilde{H}_i^k &= \max_j \{ \tilde{v}_{ij}^k \} \\ &= \max_j \left\langle \left( \frac{l_{ij}^k}{l_j^*}, \frac{t_{ij}^k}{l_j^*}, \frac{\bar{l}_{ij}^k}{l_j^*} \right); w_{T_{ij}^k}, u_{T_{ij}^k} \right\rangle \end{aligned}$$

The TIF payoff matrix is converted into crisp matrix by using (1)

$$\tilde{H}_i^k = \max_j \{ t_{ij}^k \} \tag{6}$$

And  $\tilde{H}_i = \max_k \{ \tilde{H}_i^k \}$

$$\tilde{H}_{opt} = \max_i \{ \tilde{H}_i \} \tag{7}$$

According to pataki[15] the constant  $z$  is used in the purpose of finding the balance between the maximum confidence and the minimum non-confidence levels during the decision making and  $z$  lies between 0 and 1,

$$z\tilde{W}_{opt} + (1 - z)\tilde{H}_{opt} = \max_i \{ z\tilde{W}_i + (1 - z)\tilde{H}_i \}$$

**Savage Criterion**

The regret  $\tilde{G}_{ij}^k$  is defined as[14]

$$\tilde{G}_{ij}^k = \max_k \max_i \{ \tilde{v}_{ij}^k \} - \tilde{v}_{ij}^k$$

The MADM process is applied on the values of  $\tilde{v}_{ij}^k$ , then the TIF payoff matrix is converted into crisp matrix  $t_{ij}^k$ . Then

$$\tilde{G}_{ij}^k = \max_k \max_i \{ t_{ij}^k \} - t_{ij}^k \tag{8}$$

$\tilde{Y}_i = \max_k \max_j \{ \tilde{G}_{ij}^k \}$

$$\tilde{Y}_{opt} = \min_i \{ \tilde{Y}_i \} \tag{9}$$

**Implementing the proposed Method in the field of Agriculture**

In this example a farmer needs to select which of the three crops he can plant in his 100 acre farm. The farmer’s profit depends on the rainfall during the season. And the farmer also has to decide which type of the three crops he can plant regarding the rainfall.

The average rainfall in the state is considered as 998cm. so the three states of nature of the game are

- i. Below average rainfall (BR)
- ii. Average rainfall (AR)
- iii. Excess rainfall (ER).

The three crops taken into account here are

Crop A: Cereals

Crop B: Pulses

Crop C: Oil Seeds

And the types of the crops are listed according to their harvesting time. The short term crops are the ones harvested between 90 to 120 days, medium crops are harvested between 120 to 140 days and the long term crops are between 140 to 180 days, which is used as

Type SD : Short duration

Type MD : Medium duration





**Sasikala and Sahathana Thasneem**

Type LD : Long duration

The payoff values are in the form of Triangular Intuitionistic Fuzzy numbers with the degrees of membership and non- membership. In the payoff matrix the row block represents the alternatives of the crops A, B and C. The column block denotes the type of the crops SD, MD and LD. And the page block denotes the level of the rainfall BR, AR and ER . The payoff matrix is the production of crops in kilogram/ hectare(kg/ha).

$$\tilde{L} = \begin{bmatrix} \tilde{L}^1 = \left[ \begin{array}{ccc} \langle(3045,3052,3060); 0.5,0.4\rangle & \langle(1638,1642,1650); 0.6,0.3\rangle & \langle(2705,2712,2720); 0.6,0.4\rangle \\ \langle(550,555,560); 0.4,0.5\rangle & \langle(508,517,522); 0.5,0.2\rangle & \langle(958,967,972); 0.7,0.2\rangle \\ \langle(2105,2114,2120); 0.6,0.3\rangle & \langle(1106,1110,1118); 0.7,0.3\rangle & \langle(407,415,421); 0.6,0.4\rangle \end{array} \right] \\ \tilde{L}^2 = \left[ \begin{array}{ccc} \langle(3070,3078,3085); 0.6,0.2\rangle & \langle(1442,1447,1456); 0.8,0.2\rangle & \langle(3126,3140,3143); 0.7,0.1\rangle \\ \langle(578,586,590); 0.7,0.2\rangle & \langle(608,618,626); 0.6,0.4\rangle & \langle(969,980,992); 0.3,0.5\rangle \\ \langle(2310,2500,2510); 0.8,0.1\rangle & \langle(1253,1250,1268); 0.5,0.4\rangle & \langle(534,540,552); 0.7,0.3\rangle \end{array} \right] \\ \tilde{L}^3 = \left[ \begin{array}{ccc} \langle(3465,3480,3498); 0.8,0.2\rangle & \langle(1364,1377,1385); 0.6,0.4\rangle & \langle(3372,3380,3394); 0.5,0.4\rangle \\ \langle(548,562,570); 0.7,0.2\rangle & \langle(565,573,584); 0.6,0.3\rangle & \langle(1036,1049,1057); 0.4,0.5\rangle \\ \langle(2496,2500,2510); 0.8,0.1\rangle & \langle(1498,1504,1517); 0.5,0.2\rangle & \langle(505,512,521); 0.6,0.4\rangle \end{array} \right] \end{bmatrix}$$

The payoff matrix in 3D form is given in fig1.

$$\tilde{v}_{ij}^k = \left\langle \left( \frac{l_{ij}^k}{l_j^*}, \frac{t_{ij}^k}{t_j^*}, \frac{\bar{l}_{ij}^k}{\bar{l}_j^*} \right); w_{r_{ij}^k}, u_{r_{ij}^k} \right\rangle$$

Then  $\tilde{L}^1, \tilde{L}^2$  and  $\tilde{L}^3$  becomes

$$\tilde{L}^1 = \left[ \begin{array}{ccc} \langle(7.48,7.5,7.52); 0.5,0.4\rangle & \langle(4.02,4.03,4.05); 0.5,0.4\rangle & \langle(6.65,6.66,6.68); 0.5,0.4\rangle \\ \langle(1.35,1.36,1.38); 0.5,0.4\rangle & \langle(1.25,1.27,1.28); 0.5,0.4\rangle & \langle(2.35,2.38,2.39); 0.5,0.4\rangle \\ \langle(5.17,5.19,5.21); 0.5,0.4\rangle & \langle(2.72,2.73,2.75); 0.5,0.4\rangle & \langle(1.1,0.2,1.03); 0.5,0.4\rangle \end{array} \right]$$

$$\tilde{L}^2 = \left[ \begin{array}{ccc} \langle(5.75,5.76,5.78); 0.6,0.2\rangle & \langle(2.70,2.71,2.73); 0.8,0.2\rangle & \langle(5.85,5.88,5.89); 0.7,0.1\rangle \\ \langle(1.08,1.10,1.11); 0.7,0.2\rangle & \langle(1.14,1.16,1.17); 0.6,0.4\rangle & \langle(1.81,1.84,1.86); 0.3,0.5\rangle \\ \langle(4.33,4.34,4.35); 0.4,0.6\rangle & \langle(2.33,2.34,2.37); 0.5,0.4\rangle & \langle(1.1,0.1,1.03); 0.7,0.3\rangle \end{array} \right]$$

$$\tilde{L}^3 = \left[ \begin{array}{ccc} \langle(6.86,6.89,6.93); 0.8,0.2\rangle & \langle(2.70,2.73,2.74); 0.6,0.4\rangle & \langle(6.68,6.69,6.72); 0.5,0.4\rangle \\ \langle(1.09,1.11,1.13); 0.7,0.2\rangle & \langle(1.12,1.13,1.16); 0.6,0.3\rangle & \langle(2.05,2.08,2.10); 0.4,0.5\rangle \\ \langle(4.94,4.95,4.97); 0.8,0.1\rangle & \langle(2.97,2.98,3); 0.5,0.2\rangle & \langle(1.1,0.1,1.03); 0.6,0.4\rangle \end{array} \right]$$

**Laplace Criterion:**

From (2) the values of  $\tilde{r}_1, \tilde{r}_2$  and  $\tilde{r}_3$  are

$$\tilde{r}_1 = \left\langle \left( \frac{1}{3}(48.69), \frac{1}{3}(48.85), \frac{1}{3}(49.04) \right); 0.5,0.4 \right\rangle$$

$$= \langle(16.23,16.28,16.35); 0.5,0.4\rangle$$

$$\tilde{r}_2 = \left\langle \left( \frac{1}{3}(13.24), \frac{1}{3}(13.43), \frac{1}{3}(13.57) \right); 0.3,0.5 \right\rangle$$

$$= \langle(4.41,4.48,4.52); 0.3,0.5\rangle$$

$$\tilde{r}_3 = \left\langle \left( \frac{1}{3}(25.46), \frac{1}{3}(25.57), \frac{1}{3}(25.74) \right); 0.4,0.6 \right\rangle$$

$$= \langle(8.49,8.52,8.58); 0.4,0.6\rangle$$

Using (), the values of  $\tilde{r}_1, \tilde{r}_2$  and  $\tilde{r}_3$  in TIFN are converted into crisp payoff values.

$$\tilde{L}_{opt} = \max_{i=1,2,\dots,m} \{\tilde{r}_i\}$$

$$= \max_i \{4.49, 0.9, 1.71\}$$

$$= 4.49$$

The laplace criterion suggests choosing the crop A.

**Wald Criterion:**

From (1),(4) the TIF payoff matrix is converted into crisp payoff matrix. Then  $\tilde{L}$  becomes

$$\tilde{L} = \left[ \tilde{L}^1 = \begin{bmatrix} 2.063 & 1.314 & 2 \\ 0.308 & 0.413 & 0.892 \\ 1.694 & 0.960 & 0.307 \end{bmatrix}, \tilde{L}^2 = \begin{bmatrix} 2.021 & 1.094 & 2.352 \\ 0.414 & 0.349 & 0.373 \\ 0.872 & 0.652 & 0.352 \end{bmatrix}, \tilde{L}^3 = \begin{bmatrix} 2.761 & 0.823 & 1.844 \\ 0.422 & 0.371 & 0.473 \\ 2.111 & 0.972 & 0.314 \end{bmatrix} \right]$$

The wald criterion is





**Sasikala and Sahathana Thasneem**

$$\begin{aligned} \tilde{W}_i^k &= \min_j \{t_{ij}^k\} \\ &= \{(1.314, 0.308, 0.307)^T, (1.094, 0.349, 0.352)^T, (0.823, 0.371, 0.314)^T\} \\ \tilde{W}_i &= \min_i \{\tilde{W}_i^k\} = \{0.823, 0.308, 307\} \\ \tilde{W}_{opt} &= \max_i \{\tilde{W}_i\} = 0.823 \end{aligned}$$

The wald criterion advise the player to choose the first alternative which is crop A.

**Hurwicz Criterion**

The Hurwicz criterion is

$$\begin{aligned} \tilde{H}_i^k &= \max_j \{t_{ij}^k\} \\ &= \{(2.063, 0.892, 1.694)^T, (2.352, 0.414, 0.872)^T, (2.761, 0.473, 2.111)^T\} \\ \tilde{H}_i &= \max_k \{\tilde{H}_i^k\} = \{2.761, 0.892, 2.111\} \\ \tilde{H}_{opt} &= \max_i \{\tilde{H}_i\} = 2.761 \end{aligned}$$

The Hurwicz criterion recommends to choose crop A. And for  $z = 0.5$ ,

$$\begin{aligned} z\tilde{W}_{opt} + (1 - z)\tilde{H}_{opt} &= \max_i \{z\tilde{W}_i + (1 - z)\tilde{H}_i\} \\ &= \max_i \{3.67, 0.6, 1.21\} = 3.67 \end{aligned}$$

Which also suggests crop A.

**Savage Criterion**

Using  $\tilde{R}_{ij}^k = \max_k \max_i \{t_{ij}^k\} - t_{ij}^k$ , the regret matrix is

$$\begin{aligned} G &= \left[ \begin{array}{l} G^1 = \begin{bmatrix} 0.713 & 0 & 0.353 \\ 2.452 & 0.910 & 1.464 \\ 1.071 & 0.352 & 2.043 \end{bmatrix}, G^2 = \begin{bmatrix} 0.741 & 0.222 & 0 \\ 2.353 & 0.961 & 1.984 \\ 1.890 & 0.667 & 1.998 \end{bmatrix}, \\ G^3 = \begin{bmatrix} 0 & 0.493 & 0.512 \\ 2.342 & 0.941 & 1.884 \\ 0.653 & 0.344 & 2.041 \end{bmatrix} \\ \tilde{Y}_i = \max_k \max_j \{G_{ij}^k\} \\ = \{(0.741, 2.452, 2.043)^T\} \\ \tilde{Y}_{opt} = \min_i \{\tilde{Y}_i\} = 0.741 \end{array} \right] \end{aligned}$$

The savage criterion also suggest choosing crop A. so all the decision criteria used here suggests crop A is the best choice for the farmer to obtain maximum production with respect to the rainfall.

**CONCLUSION**

In the decision making situation dealing with uncertainties the proposed extension criteria can be used to find the proper course of action for the decision maker. The ranking model proves that the Intuitionistic fuzzy game theory is feasible in 3D payoff matrix as well. Consequently the improved technique may be applicable in many areas. The case of higher number of states of nature and multi dimension are left for future study.

**Disclosure Statement**

The authors declare that they have no known competing financial interests or personal relationships that could have appeared to influence the work reported in this paper.

**REFERENCES**

1. Ankan Bhaumik, S.K.Roy (2017), Analysis of Triangular Intuitionistic fuzzy matrix games using Robust ranking, Journal of Intelligent & Fuzzy Systems, vol-33, 327-336.

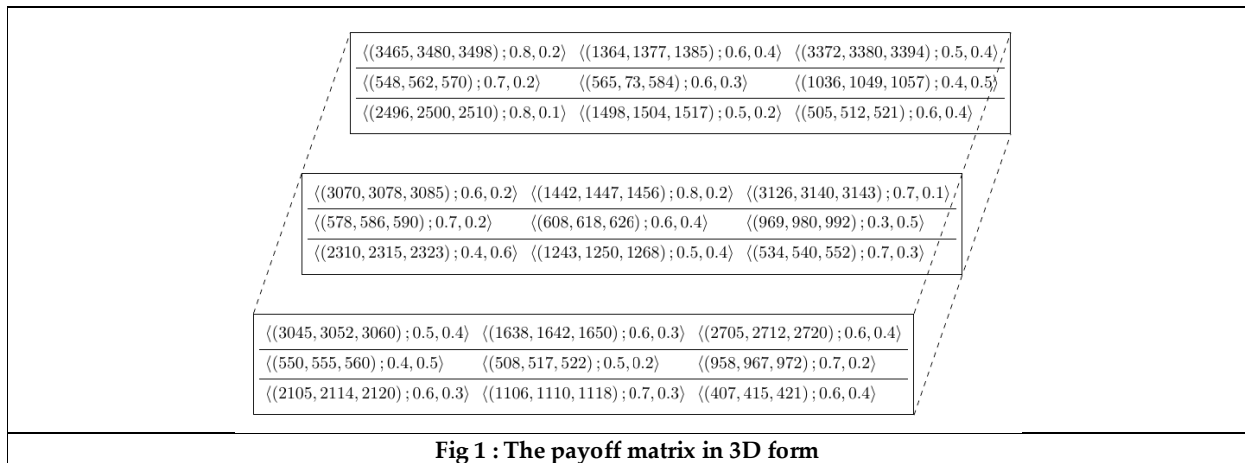






**Sasikala and Sahathana Thasneem**

2. Deng-Feng Li (2010), A Ratio ranking method of Triangular Intuitionistic fuzzy numbers and it's application to MADM problems, Computers and Mathematics with applications, 1557-1570.
3. Deng-Feng Li (2010), A Lexicographic method for matrix games with payoffs of Triangular Intuitionistic Fuzzy Numbers, International Journal of computational Intelligence systems, vol-3, 280-289.
4. H.J. Zimmermann (1985), Fuzzy Set Theory and It's applications, Norwell.
5. Hurwicz. L, (1951), Generalized Bayes Minimax principle: A criterion for decision-making under uncertainty, cowles, comm-discuss.pap.stat,355,1-7.
6. Izgi.B, özkaya .M (2018), Fundamental concept of 3D matrices, AIP conference proceedings,1991, 020008 .
7. J.VonNuemann, D.Morgenstern (1944), The Theory of games in Economic Behaviour, New York .
8. Jiang-Xia Nan, Man-Jun Zhang (2014), A Methodology for matrix games with payoffs of Triangular Intuitionistic fuzzy number, Journal of Intelligent & fuzzy systems, vol-26, 2899-2912.
9. K.Atrassov (1986), Intuitionistic fuzzy sets, Fuzzy sets and systems, 87-96.
11. L.A.Zadeh (1965), Fuzzy sets, Inform contr.vol-8,338-353.
12. Laplace.P.S (1812), TheorieAnaitique des probabilities; courcier: paris, France,vol-7.
13. M.R.Seikh, P.K.Nayak,M.Pal (2015), Solving Bi-Matrix games with payoffs of Triangular Intuitionistic fuzzy numbers, European Journal of pure and Applied mathematics, vol-8,153-171.
14. Milnor.J.W (1951), Game Against Nature, RAND corporation, Santa Monica,CA,USA.
15. özkaya .M, Izgi.B, Perc.M (2022), Axioms of Decision Criteria for 3D matrix games and their applications,10,4524.
16. Pataki,B.A (1996), A Critique of some classical theories od decision under uncertainty, PeriodicaPolytechnicaser.soc and manag.sci, vol-4, 79-92.
17. Savage,L.J (1951), The theory of statistical decision J.Am.stat.Assoc,46,55-67.
18. S.Bandyopadhyay, P.K.Nayak, M.Pal (2013), Solution of matrix game with Triangular Intuitionistic fuzzy payoff using Score function, Open Journal of Optimization, vol-2, 9-15.





## Formulation and Evaluation of Dolutegravir Tablets for the Treatment of HIV Infections

Anne Ramu<sup>1\*</sup>, Suryadevara Vidyadhara<sup>2</sup>, Janga Ramesh Babu<sup>1</sup> and Battula Sowjanya Lakshmi<sup>3</sup>

<sup>1</sup>Professor, Department of Pharmaceutics, Chebrolu Hanumaiah Institute of Pharmaceutical Sciences, (Affiliated to Acharya Nagarjuna University) Guntur, Andhra Pradesh, India.

<sup>2</sup>Professor and Principal, Department of Pharmaceutics, Chebrolu Hanumaiah Institute of Pharmaceutical Sciences, (Affiliated to Acharya Nagarjuna University) Guntur, Andhra Pradesh, India.

<sup>3</sup>Assistant Professor, Department of Pharmaceutics, Chebrolu Hanumaiah Institute of Pharmaceutical Sciences, (Affiliated to Acharya Nagarjuna University) Guntur, Andhra Pradesh, India.

Received: 12 Jan 2024

Revised: 22 Mar 2024

Accepted: 26 Apr 2024

### \*Address for Correspondence

**Anne Ramu**

Professor,

Department of Pharmaceutics,

Chebrolu Hanumaiah Institute of Pharmaceutical Sciences,

(Affiliated to Acharya Nagarjuna University)

Guntur, Andhra Pradesh, India.

Email: ramuane2601@gmail.com



This is an Open Access Journal / article distributed under the terms of the **Creative Commons Attribution License** (CC BY-NC-ND 3.0) which permits unrestricted use, distribution, and reproduction in any medium, provided the original work is properly cited. All rights reserved.

### ABSTRACT

The current research was to enhance solubility and dissolution rate of the poorly soluble antiviral drug, dolutegravir, solid dispersions by physical mixing, solvent evaporation and kneading techniques, with kollidon VA64. The solid dispersions prepared are tested for flow properties, drug content, and particle size. *In vitro* dissolution studies were carried out to analyze the drug release from solid dispersions. Crystal morphology, drug and polymer interaction for selected solid dispersions was studied by FT-IR and DSC analysis. Controlled release tablets were formulated by using optimized solid dispersions using different concentrations of hydrophilic polymers employing direct compression technique. The tablets prepared are tested for Weight variation, friability, disintegration, content uniformity and hardness. The mechanism and kinetics of drug release from the tablets were tested by *in-vitro* dissolution studies. The current research proves that combining solid dispersions along with the use of hydrophilic polymers is novel approach to formulate of dolutegravir tablets for controlled release of drug.

**Keywords:** Dolutegravir, solid dispersions, kollidonVA64, controlled release tablets, direct compression technique.



Anne Ramu *et al.*,

## INTRODUCTION

Oral drug delivery is a simple method for administering solid dosage forms due to its relative stability, less bulk, dosage accuracy, and ease of production.[1,2] It offers numerous advantages over other forms. The bio availability of a drug depends on its solubility and less bioavailability can detract from the efficacy of drug efficacy. Many new chemical entities are poorly water-soluble, making oral administration difficult.[3,4] Solid dispersions are solid products consisting of hydrophobic drug with hydrophilic matrix. The drug is dispersed as crystalline particles or amorphous particles [5] Polymers are used to form matrix, and the selection of this is based on factors like physico-chemical and pharmacokinetic limitations.[6] Amorphous solid dispersions are classified based on molecular interaction between drug and carrier at molecular level in solid solutions, solid suspensions, or both. The effect of drug load on release of drug from solid dispersions is different, with some of the studies showing rapid release of drug at lesser loads of drug.[7] Controlled release drug delivery systems have received much attention in the past two decades with numerous technologically sophisticated products on the market place. Such advancements have come about by convergence of many factors, including the discovery of novel polymers, formulation optimization, better understanding of physiological and pathological constraints, prohibitive cost of developing new drug entities and the introduction of biotechnology and the biopharmaceutical principles in drug product design. The major benefits of these products lie in the optimization of drug input ratio into the systemic circulation in order to achieve an appropriate Pharmacodynamics response. This in turn would add to product safety and reduce the extent of major adverse drug reactions due to strict control of blood vessels. Furthermore, less frequent dosing, it is speculated that this should improve patient compliance and maximize drug product efficiency in therapeutics. Dolutegravir is a medication used to treat HIV infection in adults and children aged 4 weeks and older. Dolutegravir belongs to the HIV integrase inhibitors class, which works by decreasing HIV levels and increasing immune cell numbers.[8] While it does not cure HIV, using it with other medications may reduce the risk of developing AIDS and other HIV-related illnesses. Dolutegravir is a poorly soluble antiretroviral drug that belongs to BCS class II approved by the FDA for treatment of HIV infections; however, DTG has several shortcomings, including low solubility in water, low oral bioavailability. After oral administration, 84% of the dose is excreted from the body in an unchanged form due to its poor solubility. The current research aims to enhance solubility and rate of dissolution by preparing solid dispersions and to prepare controlled release tablets.

## MATERIALS & METHODS

### Materials

Dolutegravir was gifted by Natco Pharma Ltd., Hyderabad, KollidonVA64, and Microcrystalline Cellulose (Avicel pH 101) are purchased from commercial sources, and potassium dihydrogen phosphate and sodium hydroxide were procured commercially.

### Methods

#### Dolutegravir Estimation

Various methods are reported for dolutegravir estimation by spectrophotometry.[9] The study presents a simple, sensitive, and accurate method for estimating dolutegravir using spectrophotometry, measuring absorbance values at a  $\lambda_{max}$  of 258 nm.

#### Saturated Solubility Studies

The solubility of dolutegravir was studied using different dissolution media. The drug was weighed, transferred into separate flasks, and kept in a incubator shaker for 24 hours. After 24 hours, the flasks were filtered and diluted with same media. The absorbance was checked at 258 nm employing same medium as blank solution. This process involved transferring 500 mg of drug and 50 ml of different media.





Anne Ramu et al.,

### Solid Dispersions Preparation

The study focused on formulation of solid dispersions of dolutegravir employing KollidonVA64 as carrier, maintaining a constant drug concentration while using various carrier concentrations for formulation by different techniques.[10]

### Physical Mixing

The known weight of drug (dolutegravir) & kollidonVA64 are separately weighed and sieved via sieve number 80. The materials collected are transferred to clean and dry mortar made up of with glass. Dolutegravir and carrier are triturated combinely for 5 minutes and passed through 100 sieve. The mixture obtained is collected and stored in an hermatically sealed amber colored bottle for further studies

### Solvent Evaporation

A known quantity of drug & kollidonVA64 are weighed and transfered into china dish, a small volume of methanol was added and slightly heated until dolutegravir and carrier were dissolved. Then it is evaporated at temperature not exceeding 60°C. The resulting mixture was dried, sieved through 100 No sieve. The mixture obtained is collected and stored in an hermatically sealed amber colored bottle for further studies.

### Kneading

A specific quantity of KollidonVA64 was mixed with a specific amount of drug in a china dish and then vigorously triturated at room temperature. If necessary, the mixture obtained was grinded and sieved. The resulting mixture was dried, sieved through 100 No sieve. The mixture obtained is collected and stored in a hermatically sealed amber colored bottle for further studies. Solid dispersions composition was given in Table-1.

### Solid Dispersions Evaluation

#### Physical Properties

Solid dispersions prepared were evaluated for Particle size, Carr's index and Angle of repose, according to the official compendium standards. Physical parameters of different solid dispersions are given in Table 2.

#### Drug Content Uniformity

Dolutegravir solid dispersions were taken at and placed into volumetric flask of 100 ml capacity, 90 ml of methanol is added to it and this was shaken for 30 minutes and then it was filtered. 10 ml of the filtrate was transferred into a volumetric flask of 100 ml capacity and it was made up to volume by the addition of pH 6.8 phosphate buffer. From the above 10 ml of the filtrate was subjected to centrifugation. The filtrate was further diluted and the absorbance was checked at 258nm. The drug content uniformity test was repeated for six times (N = 6) for all batches dispersions. Drug content values for different dispersions are given in Table-2.

#### In vitro Dissolution Studies

Solid dispersions dissolution studies were performed using USP TypeII apparatus using pH 6.8 phosphate buffer 900 ml as dissolution medium. At different time intervals like 5, 10, 15, 30, 45 and 60 minutes the samples were taken and placed same volume in order to exist sink conditions during the study. Samples are diluted with pH 6.8 Phosphate buffer and amount of drug dissolved is estimated at 258 nm by double beam UV spectrophotometer. Cumulative percent of drug released is calculated. Dissolution studies were repeated six times on each formulation. In Vitro dissolution parameters were calculated from the data. Table 3 provides In Vitro dissolution parameters for various solid dispersions. Dissolution profiles for different dispersions are given in figure-1.

#### Characterization Studies

Selected solid dispersions were optimized through dissolution studies performed and further characterized by FTIR and DSC studies.[11] FTIR Spectra and DSC thermograms shown in figures 2 and 3.





Anne Ramu et al.,

**FTIR Studies****DSC Studies****Preparation of Dolutegravir Controlled Release Tablets**

From the results of dissolution studies optimized dispersion was added with different concentrations of HPMCK15M, Xanthan gum, combination of both and compressed into tablets by direct compression technique.<sup>[12]</sup> The concentration of drug in all the formulations was maintained constant and different concentrations of polymer and gum were used. The Tablets weight was maintained uniform by adding MCC (Avicel pH 101) is used as diluent and directly compressible vehicle.<sup>[13]</sup> All ingredients were weighed individually sieved and subjected to blending for 15 minutes in V-cone blender. The powder mass was lubricated and compressed as tablets using a ten station mini tablet press. All tablets were compressed maintaining uniform conditions to reduce variables during preparation. Powder blends are evaluated for flow properties. Tablets were evaluated for weight variation, uniformity of content, hardness and friability loss. Table 4 shows composition for different batches of tablet formulations.

**Physical Parameters for Dolutegravir Tablets**

The physical parameters for tablets including drug content, weight uniformity, hardness, friability and disintegration were evaluated according to official compendium standards, and table 5 provides the results.

**In Vitro Dissolution Studies:**

The investigation used USP Apparatus Type II to conduct a dissolution test using 900ml of pH 6.8 Phosphate buffer as the medium. Samples were drawn during the investigation at different time periods, and the same volume was replaced to maintain sink conditions during the study. The cumulative amount drug released is estimated using UV spectrophotometer at 258nm and calculated the cumulative percentage of drug released. Dissolution studies are conducted for six times on each formulation.<sup>[14]</sup> In vitro dissolution parameters are calculated from data for different tablet formulations. Dissolution profiles of all tablets are given in Figure- 4. The spectrophotometric method for estimating dolutegravir in 6.8 Phosphate buffer was linear and reproducible, following Beer's law in the 2-10 µg/ml concentration range. Reproducibility of method was tested on six. This method is suitable for the estimation of dolutegravir in dissolution medium. Dolutegravir is classified as BCS class II in the biopharmaceutical classification, has low solubility in aqueous fluids. To study its solubility, saturated solubility studies were conducted, revealing its maximum solubility in 6.8 pH phosphate buffer. Hence it is used as dissolution medium for further investigation. Solid dispersions of dolutegravir was prepared using physical mixing method, solvent evaporation method, and kneading method using the kollidonVA64 as carrier.<sup>[15]</sup> Various solid dispersions composition are shown in table 1.

The prepared dispersions were evaluated for Carr's index and angle of repose with values ranging from 27.5-9.3% and 38.32-19.32 respectively. The particle sizes ranged from 253-176 µm, and the drug content ranged from 97.35-99.35%. All solid dispersions were stable and exhibited good flow properties, meeting specified limits for particle size, Carr's index, angle of repose and uniformity of content. The physical parameters for all solid dispersions are provided in the table no:2. In vitro dissolution studies were conducted for various solid dispersions using pH 6.8 Phosphate buffer. Kneading method is found most effective for rapid drug release in solid dispersions like DK3, with a drug and polymer ratio of 1:2. The R<sup>2</sup> values ranged from 0.906 to 0.968, indicating linearity with a first order rate constant. The order of increasing solubility and dissolution rate was kneading > solvent evaporation > physical mixing. DK3 prepared by the kneading method showed complete solubility enhancement, making it ideal for compression into controlled release tablets. In vitro dissolution parameters were provided in table -3 and dissolution profiles are given in figure no:1. The optimized solid dispersion was chosen from dissolution studies and further investigated for drug-carrier interaction through IR, DSC studies. FTIR spectrum for dolutegravir, optimized formulation showed same peaks, indicating no drug excipient interactions. DSC analysis was performed pure drug, optimized solid dispersion (DK3) prepared using kneading method. Thermogram of pure drug and optimized dispersion (DK3) exhibit onset of peak at 384.73°C indicating no interaction between the dolutegravir and kollidonVA64.<sup>[16]</sup> IR Spectra, DSC thermograms are presented in figure no:3. The study selected solid dispersions with a rapid dissolution profile for formulation in to controlled tablets, using HPMCK<sub>15</sub>M and xanthan gum. The

73752





Anne Ramu et al.,

drug concentration remained constant, while carrier concentration varied for different batches. Direct compression technique was suitable for compression of optimized solid dispersions into tablets. All tablets are compressed under similar conditions to reduce variables during preparation.<sup>[17]</sup> Different tablet formulations composition was given in table 4. The study evaluated tablet formulations for physical parameters, revealing that all the formulations were stable and met specified limits according I.P. for drug content, weight uniformity, dispersion time and friability. Hardness of the tablets ranged from 4.9-5.5±0. kg/cm<sup>2</sup>, with weight uniformity ranging from 348 to 353±4 mg. Friability loss was negligible, and drug content was uniform for all the tablets with not more than 2.5% variation. In vitro dissolution showed that Formulation F7 with HPMCK15M and xanthan gum in the concentration of 1:1 extended the release of drug when compared to other tablets. The first order R<sup>2</sup> values were linear, with first order rate constants ranging from 0.954 - 0.995. Formulation F7 prepared using HPMCK15M and xanthan gum was suitable for controlled release tablets. The In Vitro dissolution Parameters for different dolutegravir tablets were given in table- 6. Dissolution profiles were shown in figure 4.

## CONCLUSION

The present work found that kollidonVA64 is an effective carrier for improving the solubility and dissolution of BCS class II drug dolutegravir. Kneading method was found to increase dissolution rate rapidly. Tablets prepared using kneading method dispersions and HPMCK15M and xanthan gum was suitable for controlled release tablets.

## ACKNOWLEDGMENT

The authors express gratefulness to Apotex Pharmaceuticals Ltd, for their gift samples and Chebrolu Hanumaiah Institute of Pharmaceutical Sciences, Guntur management for providing necessary facilities for doing the work.

## ABBREVIATIONS

BCS - Biopharmaceutics Classification System,  
DSC - Differential Scanning Calorimetry, Dolutegravir,  
FT-IR -Fourier Transform Infrared Spectroscopy,  
HIV - Human Immunodeficiency Virus,  
HPMC -Hydroxy Propyl methyl Cellulose,  
MCC -Microcrystalline Cellulose.

### Conflict of Interest

The authors express no conflict of interest about this work in the manuscript.

## REFERENCES

1. Punitha S, Srinivasa Reddy G, Srikrishna T, Lakshman Kumar M. Solid Dispersions A Review. Journal of Pharmacy and Technology 2011;4: 331-334.
2. Kuldeep M, Ashok Y, Sunil K, Pankaj R. (2011). Fast Dissolving Drug Delivery System A Review. Research Journal of Pharmacy and Technology 2011;4:842-850.
3. Sneha DB. A Review on Solid Dispersion as a Technique for Enhancement of Bioavailability of Poorly Water Soluble Drugs. Research Journal of Pharmacy and Technology 2014; 7: 96-100.
4. Sajid Ali MD, Sarfaraz A, Sarfaraz MD, Nawazish AM. Research Trend in Fast Dissolving Tablets An Overview. Journal of Pharmacy and Technology 2016;9: 69-78.





**Anne Ramu et al.,**

5. Keerthi M, Rama Rao N, Santhosh Aruna M, Lakshmi Prasanna J. Solid Dispersions An Approach to Enhance the Dissolution Rate of Clopidogrel Bisulphate. Asian Journal of Research in Pharmaceutical Sciences 2014;4:165-168.
6. Pratiksha SD, Yashpal M. (2021) Formulation and Evaluation of Orodispersible Tablet. Asian Journal of Research in Pharmaceutical Sciences 2021;11: 267-272.
7. Neha S, Seema T, Bajaj A, Nikita S. Fast Dissolving Tablets A novel approach in the Delivery System. Journal of Pharmacy and Technology 2016;6:148-154.
8. Amedeo C, Mariacossu, Laura P. (2018) Dolutegravir plus ripivirine dual therapy in treating HIV-1 infection. Expert opinion on pharmacotherapy 2018;19:155-159.
9. Bhavar GB, Asher K, Ravindra Y. Development and validation of UV spectrophotometric method for estimation of Dolutegravir sodium in tablet Dosage Form. Malaysian Journal of Analytical Sciences 2015;19: 1156 – 1163.
10. Dhavalkumar M, Tiwari Ajaykumar. A research on improvisation in dissolution of olmesartan medoxomil by enhancing its solubility using solid dispersion techniques. World Journal of Pharmaceutical Research 2013; 2: 1793-1816.
11. Moneghini M. Processing of carbamazepine-PEG 4000 solid dispersions with supercritical carbon dioxide preparation, characterization, and in vitro dissolution. International Journal of Pharmaceutics 2001;222:129-138.
12. Rajat K, Snehamayee M, Satyabrata BA, Debjyoti D, Bhaktibhusan B. (2010) Formulation and In Vitro Characterization of Xanthan Gum-Based Sustained Release Matrix Tablets of Isosorbide-5- Mononitrate. Iranian Journal of Pharmaceutical Research 2010; 9:13-19.
13. Varshosaz, J, Tavakoli N, Kheirilahi F. Use Of Hydrophilic Natural Gums in Formulation of Sustained Release Matrix Tablets of Tramadol Hydrochloride. AAPS Pharm Sci Tech 2006;7:168-174.
14. Sangeetha S, Harish G, Malay KS. Formulation and Evaluation of Oro Sustained Release In situ Gelling Sol Using Xanthan Gum. International Journal of Pharma and Bio Sciences 2010;1:1-8.
15. Arun Prasad. K, Narayanan.N, Rajalakshmi.G. Preparation and Evaluation of Solid Dispersion of Terbinafine Hydrochloride. International Journal of Pharmaceutical Sciences Review and Research 2010;3:130-134.
16. Bindu Madhavi.B et al. Preparation, characterization, and tableting of a solid dispersion of Simvastatin with super disintegrants. Journal of Pharmacy Research 2010;3: 2568-2570.
17. Manivannan R, Venkata Krishna Reddy P, Lakshmi Narayana Rao B. (2013) Formulation Development and Evaluation of Voriconazole Sustained Release Tablets. International Current Pharmaceutical Journal 2013; 2:165-169.

**Table 1 Dolutegravir Solid Dispersions Composition**

S.No	Solid Dispersion Code	Composition
		<b>Drug : Polymer (Dolutegravir: Kollidon VA64)</b>
1	DP1	1:0.5
2	DP2	1:1
3	DP3	1:2
4	DS1	1:0.5
5	DS2	1:1
6	DS3	1:2
7	DK1	1:0.5
8	DK2	1:1
9	DK3	1:2

\*One dose is equivalent to 50mg.





Anne Ramu et al.,

Table 2: Dolutegravir Solid Dispersions Physical Parameters

S.No	Solid Dispersion	Angle of repose(°)	Carr's Index	%Drug Content	Particle Size
1	DPD	38.32	27.5	---	53±4µm
2	DP1	35.22	16.3	99.35	176±2µm
3	DP2	29.68	16.1	97.35	180±4µm
4	DP3	26.85	13.4	98.20	179±2µm
5	DS1	25.55	13.3	97.35	179±4µm
6	DS2	24.87	12.4	97.60	181±6µm
7	DS3	24.64	11.1	98.15	180±4µm
8	DK1	22.98	13.2	98.20	180±2µm
9	DK2	20.11	12.1	97.65	182±2µm
10	DK3	19.32	9.3	98.10	180±4µm

Table 3: Dolutegravir Solid Dispersions *In Vitro* Dissolution Parameters

S.No	CODE	T <sub>50</sub>	T <sub>90</sub>	DE <sub>30%</sub>	First order		Hixson -crowell	
					K <sub>1</sub> (min <sup>-1</sup> )	R <sup>2</sup>	K	R <sup>2</sup>
1	DPD	>60	>90	10	0.006	0.947	0.015	0.966
2	DP1	>60	>90	18	0.008	0.878	0.020	0.927
3	DP2	>60	>90	20	0.009	0.855	0.022	0.904
4	DP3	>60	>90	23	0.009	0.915	0.023	0.908
5	DS1	47.5	>90	25	0.012	0.944	0.032	0.965
6	DS2	31.5	>90	30	0.016	0.940	0.037	0.963
7	DS3	21.5	>90	35	0.018	0.906	0.040	0.949
8	DK1	19	>90	36	0.010	0.949	0.049	0.956
9	DK2	16	>90	45	0.029	0.941	0.056	0.948
10	DK3	11	52	51	0.043	0.968	0.071	0.977

Table 4: Composition of Dolutegravir Tablets

S.No	Formulation	Ingredients (mg /Tablet)						
		DK3	HPMC K <sub>15</sub> M	XG	MCC	Mg Stearate	Talc	Wt of Tablet (mg)
1	F1	150	25	-	175.5	1.75	1.75	350
2	F2	150	50	-	146.5	1.75	1.75	350
3	F3	150	75	-	121.5	1.75	1.75	350
4	F4	150	150	-	46.5	1.75	1.75	350
5	F5	150	125	25	46.5	1.75	1.75	350
6	F6	150	100	50	46.5	1.75	1.75	350
7	F7	150	75	75	46.5	1.75	1.75	350







Anne Ramu et al.,

Table 5: Physical Parameters for Dolutegravir Tablets

S.No	Formulation	Weight Uniformity(mg) N=20	Hardness (Kg/cm <sup>2</sup> )	%Friability N=10	Drug Content (mg) N=10
1	F1	351±2.0	5.1±0.3	0.28	50±1.2
2	F2	352±2.0	4.9±0.3	0.29	49±1.5
3	F3	351±3.0	5.1±0.3	0.24	50±1.2
4	F4	353±4.0	5.0±0.3	0.27	49±1.5
5	F5	348±2.0	5.5±0.3	0.29	50±1.2
6	F6	351±2.0	5.3±0.3	0.33	50±1.2
7	F7	353±4.0	5.3±0.3	0.29	49±1.6

Table 6: Dissolution Parameters of Dolutegravir Tablets

S.No	Formulation	First order		Higuchi		Peppas	
		K (min <sup>-1</sup> )	R <sup>2</sup>	K (mg <sup>1/2</sup> )	R <sup>2</sup>	n	R <sup>2</sup>
1	F1	0.08	0.976	22.66	0.988	0.749	0.995
2	F2	0.09	0.954	23.03	0.986	0.937	0.979
3	F3	0.11	0.966	25.80	0.996	0.626	0.992
4	F4	0.13	0.956	26.35	0.989	0.566	0.990
5	F5	0.07	0.973	21.60	0.975	0.889	0.988
6	F6	0.11	0.995	26.80	0.976	0.931	0.995
7	F7	0.30	0.910	33.90	0.982	0.918	0.985

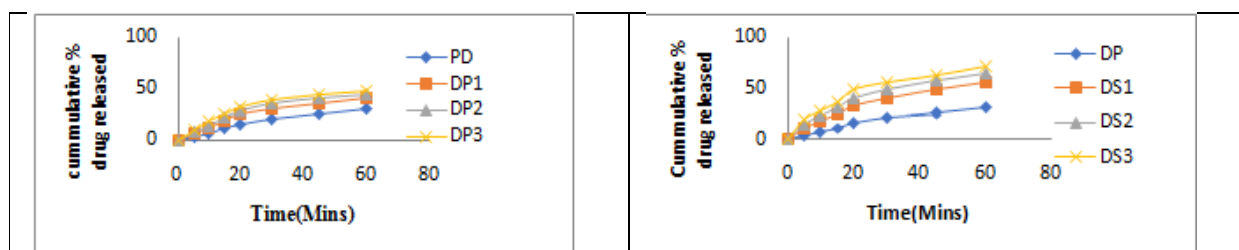


Figure1 (a): Dissolution Profiles for Dolutegravir Solid

Figure1 (b): Dispersions prepared by Physical Mixing

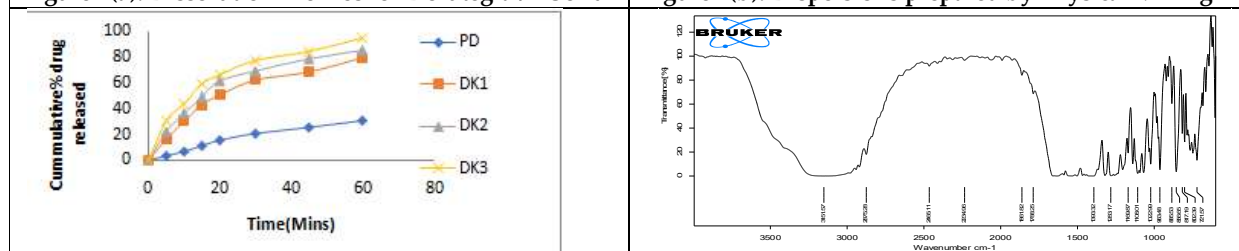


Figure 1 (c) : Solvent Evaporation and Kneading Methods

Figure 2 (a): FTIR Spectra's of Pure Drug





Anne Ramu et al.,

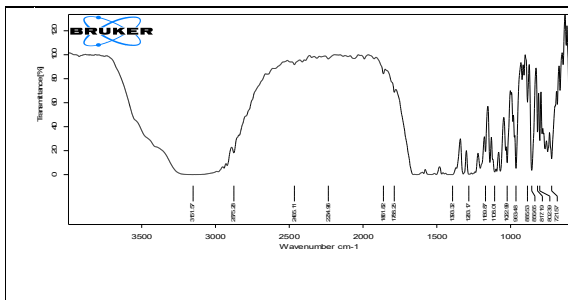


Figure 2 (b) Optimised Dispersion (DK3)

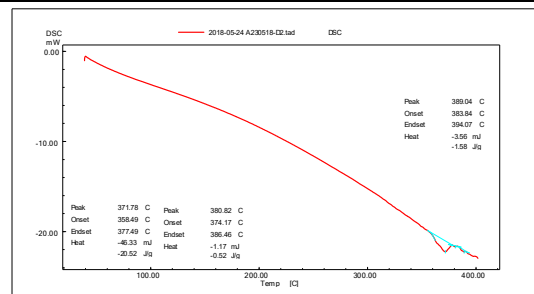


Figure 3(a) : DSC Thermogram for Dolutegravir drug

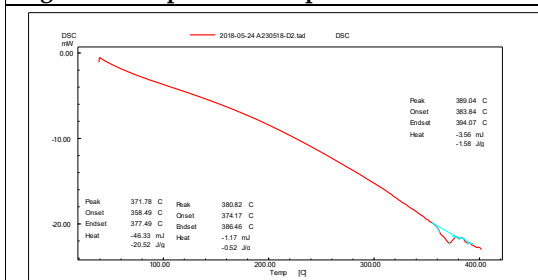


Figure 3 (b) Optimised Dispersion(DK3)

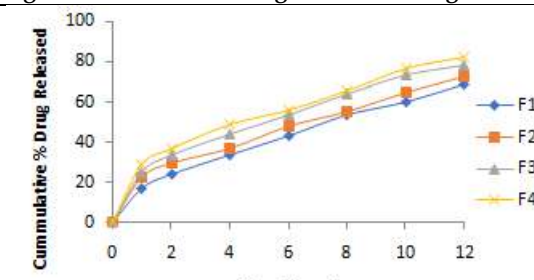


Figure 4(a): Dolutegravir Tablets Dissolution Profiles

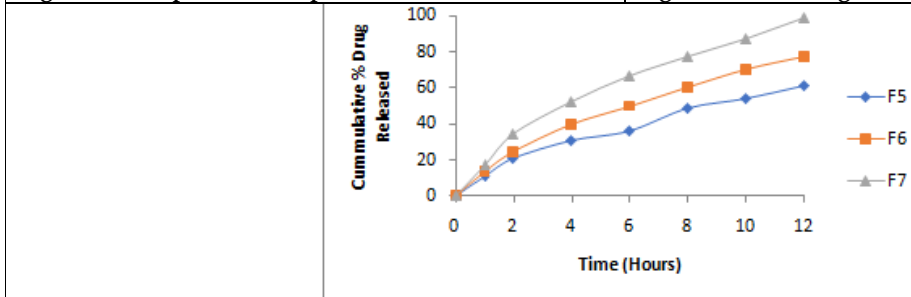


Figure 4(b): Dolutegravir Tablets Dissolution Profiles





## Development and Validation of RP-HPLC Method for Raltegravir Potassium in Bulk and Tablet Dosage Form

Anusha Gandhi<sup>1\*</sup>, Sai Swetha.K<sup>2</sup> and Kavya Sri.K<sup>2</sup>

<sup>1</sup>Assistant Professor, Department of Pharmaceutical Analysis, Vignan Institute of Pharmaceutical Technology, Visakhapatnam, (Affiliated to Jawaharlal Nehru Technological University) Gurajada Vizianagaram) Andhra Pradesh 530049, India.

<sup>2</sup>Student, Department of Pharmaceutical Analysis, Vignan Institute of Pharmaceutical Technology, Visakhapatnam, (Affiliated to Jawaharlal Nehru Technological University) Gurajada Vizianagaram) Andhra Pradesh 530049, India.

Received: 23 Jan 2024

Revised: 09 Feb 2024

Accepted: 26 Apr 2024

### \*Address for Correspondence

**Anusha Gandhi**

Assistant Professor,

Department of Pharmaceutical Analysis,

Vignan Institute of Pharmaceutical Technology,

Visakhapatnam, (Affiliated to Jawaharlal Nehru Technological University) Gurajada Vizianagaram) Andhra Pradesh 530049, India.

Email: gandianusha11@gmail.com



This is an Open Access Journal / article distributed under the terms of the **Creative Commons Attribution License** (CC BY-NC-ND 3.0) which permits unrestricted use, distribution, and reproduction in any medium, provided the original work is properly cited. All rights reserved.

### ABSTRACT

A straightforward, accurate, and sensitive RP-HPLC technique was created and approved for the measurement of raltegravir potassium in tablet and bulk dose forms. Using a binary gradient elution mode and a mobile phase consisting of a mixture of 30:70 water and HPLC grade acetonitrile and methanol, respectively, chromatographic separation was carried out on a C18 (150mm × 4.6mm, 5 μm) column at a flow rate of 1 ml/min. A PDA detector was used to monitor the detection at 221 nm. the 4.657-minute retention period. The linearity of the method was 20–100 μg/mL. In compliance with ICH criteria, this approach was validated.

**Keywords:** Raltegravir Potassium, RP-HPLC, Method Development, Method Validation.

### INTRODUCTION

HIV-1 INSTI, an inhibitor of HIV integrase strand transfer with HIV-1 antiviral efficacy, [9] Raltegravir Potassium is the potassium salt of raltegravir that can be used orally. Raltegravir binds to and inhibits the HIV enzyme integrase, which inserts viral genetic material into the genetic material of infected human cells[10,11]. HIV replication is stopped by integrase inhibition, which prevents HIV DNA from being integrated into the human DNA





Anusha Gandhi *et al.*,

genome. Potassium 4-[(4-fluorophenyl) methyl] carbamoyl} is its chemical name. [(5-methyl-1,3,4-oxadiazol-2-yl)formamido] -1-methyl-2-[2-yl propan-2-olate, 6-oxo-1,6-dihydropyrimidin-5. Its molecular weight is 444.4163 g/mol and its formula is C<sub>20</sub>H<sub>20</sub>FKN<sub>6</sub>O<sub>5</sub> [7,8]. It dissolves in water, ethanol (very slightly soluble), acetonitrile (very barely soluble), DMSO (slightly heated), and methanol (slightly heated). In order to stop the viral DNA from integrating into the human genome, raltegravir inhibits HIV integrase. The main metabolic process of raltegravir is glucuronidation [12]. Few raltegravir on RP-HPLC developed methods exist [13–19].

## MATERIALS AND METHODS

### Instrumentation

This Shimadzu HPLC has a SCL 20A system controller, a variable wavelength programmable SPD-20A detector, and an LC-20AD binary gradient pump. The data were collected using a 20 µl loop Rheodyne injector, and LC solutions software was used for data evaluation.

### Chemicals and reagents

The HPLC grade water and ammonium acetate were used to prepare the buffer during the experiment, while the HPLC grade acetonitrile and methanol were acquired from E. Merck in Mumbai, India.

### Preparation of Solutions

#### Preparation of Acetonitrile and Methanol

Acetonitrile and Methanol was sonicated for 20 mins each for 3 times. After sonication degassed, filtered the solution through 0.2 µm membrane filter before purging into the HPLC system.

#### Preparation of ammonium acetate buffer pH 4

In a 1000 ml volumetric flask, 77.0825 g/mol was added. A tiny amount of HPLC grade water was then added, and after the mixture eventually dissolved, the pH was adjusted to 4. Subsequently, the solution underwent a 30-minute sonication. Before being purged into the HPLC equipment, the mixture was allowed to degas after the sonication process and then run through a 0.2 µm membrane filter.

### Preparation of mobile phase

**Mobile phase 1:** Mobile phase A is the pH 4 ammonium acetate buffer, and mobile phase B is HPLC-grade acetonitrile. Prior to being purged into the HPLC equipment. Following a degassing procedure, a 0.2 µm membrane filter was used to filter the two mobile phase solutions.

**Mobile phase 2:** HPLC water makes up mobile phase A, and HPLC-grade acetonitrile and methanol make up mobile phase B. Prior to being purged into the HPLC system. After degassing, the two mobile phase solutions were filtered through a 0.2 µm membrane filter.

**Mobile phase 3:** HPLC water makes up mobile phase A, and HPLC-grade acetonitrile makes up mobile phase B. Prior to being purged into the HPLC system. Following a 0.2 µm membrane filter filtering, the two mobile phase solutions were degassed.

### Preparation of standard stock solution

10 mg of Raltegravir potassium were carefully weighed, transported to a 10 ml volumetric flask, and then completely filled with HPLC-grade methanol to create a stock solution containing 1000 µg/ml. One millilitre of the sample was collected from the stock solution and put in a ten millilitre volumetric flask. Methanol of HPLC grade was added to the sample to get 100 µg/ml.

### Method Development

After performing the above trails, it was observed that the following conditions were suitable for method development since the peak of the drug with less tailing factor and theoretical plates were observed. Trails





Anusha Gandhi *et al.*,

were performed until get the symmetrical peak with theoretical plates more than 2000 and Tailing factor below 1.5. The optimized chromatographic conditions is listed in Table 1 and chromatogram in Fig.2.

## METHOD VALIDATION

### a) System Suitability

The resolution and repeatability of the chromatographic system are measured using system appropriateness to see if they are enough for analysis[1]. At least 2,500 theoretical plates must be present, and the tailing factor cannot be higher than 2. Table 2 displays the outcomes.

### b) Linearity

The recommended concentration of 10 mg of raltegravir potassium was dissolved in 10 ml of HPLC-grade methanol. From the stock solution one millilitre, or 1 ml of the sample was taken and used to fill a 10-ml volumetric flask. Every time, samples were put into the HPLC at different concentrations, and the peak area of each concentration was noted. Plotting peak area versus Raltegravir potassium concentration allowed for the construction of calibration graphs, from which the regression equation was derived. Plotting the calibration graph at various concentrations of 20, 40, 60, 80, and 100 µg/ml is shown in figure 3. The outcomes were displayed in Table 3.

### c) Precision

Precision is determined by taking number of measurements in which they are under the same analytical conditions[2]. Then we have to measure the closeness of the data values to each other. The components of precision, i.e., repeatability (Intraday precision), intermediate precision and system precision in accordance with ICH guidelines were determined as follows:

#### Intermediate precision (Inter day Precision):

The intermediate precision was assessed by injecting a standard solution of Raltegravir potassium at the same concentration into six subjects on successive days. % RSD was then computed. Table 4 displayed the results.

#### Repeatability (Intraday Precision)

By repeatedly injecting (n=5) a standard solution of Raltegravir potassium at various time intervals on the same day, the instrument's precision was verified, and the percentage RSD was computed. Table 5 displayed the results. The 6 samples of same concentration was injected each time according to the conditions mentioned and peak area in HPLC was noted.

### d) Accuracy

With the aid of recovery technique an external standard addition method the method's accuracy was determined[3]. The pre-analyzed sample received additions of the known standard quantity at three distinct levels: 80%, 100%, and 120%. Three copies of each determination were made. The results were displayed in Table 6.

### e) Robustness

Minimal chromatographic conditions adjustments, such as changing the mobile phase's composition, wavelength, and flow rate to 220 nm and 222 nm, were used to evaluate the technique's resilience. [4]. The chromatograms lack of discernible fluctuations demonstrated the dependability of the RP-HPLC. The results were shown in the 7.

### f) Ruggedness

According to the USP, toughness refers to the degree of reproducibility of results achieved under a variety of circumstances, including different laboratories, analysts, instruments, environmental conditions, operators, and materials, like this sample, which was handled by various analysts[5]. The reproducibility of test results from lab to lab and analyst to analyst under typical, expected operational settings is measured by ruggedness. The results were displayed in Table 8.

### g) LOD and LOQ

A method's ability to consistently distinguish an analyte's concentration from background values is known as its limit of detection, or LOD. The lowest standard curve concentration that can be measured with a sufficient degree of





Anusha Gandhi *et al.*,

precision, accuracy, and variability is known as the limit of quantification, or LOQ. [6]. The outcomes were shown in Table 9.

## RESULTS AND DISCUSSION

## CONCLUSION

The development and validation of a precise and sensitive RP-HPLC technique for quantifying raltegravir potassium in both tablet and bulk forms mark a significant achievement. Employing a binary gradient elution mode with a mobile phase comprising a blend of water, acetonitrile, and methanol, the chromatographic separation on a C18 column yielded accurate results. The utilization of a PDA detector at 221 nm enabled precise detection, with a retention period of 4.657 minutes. The method demonstrated excellent linearity within the 20–100 µg/mL range, meeting the rigorous criteria outlined by the ICH. This robust and reliable HPLC method holds promise as a valuable tool for routine analysis, ensuring the quality and consistency of raltegravir potassium formulations in pharmaceutical applications.

## ACKNOWLEDGEMENT

We would like to thank to Chairman L. Rathaiah garu, Vignan Group of Institutions for providing necessary facilities to carry out research work.

## REFERENCES

1. P.D. Sethi, HPLC Quantitative Analysis Pharmaceutical Formulations, CBS Publishers and Distributors, New Delhi, 2001.
2. S. Ashutoshkar, Pharmaceutical drug Analysis 2<sup>nd</sup>Edn, New Age International Private Limited Publishers, 2005.
3. H. Beckett and J.B. Stenlake, Practical Pharmaceutical Chemistry, 4<sup>th</sup> Edn, C. B. S. Publishers and Distributors, New Delhi.
4. H.H. Williard, L.L. Merit, F.A. Dean, F.A. Settle, Instrumental Method of Analysis, 6<sup>th</sup> Edition C.B.S. Publishers and Distributors, New Delhi.
5. Skoog, D. A., F.J. Holler, and S.R. Crouch. 2007. Principles of Instrumental Analysis, 6<sup>th</sup> Edition. Thomson Publishing USA
6. L.R. Snyder, J.J. Kirkland, and J. W. Dolan, Introduction to Modern Liquid Chromatography, John Wiley & Sons, New York, 2009.
7. Raltegravir potassium | C20H20FKN6O5 | CID 23668479 - PubChem (nih.gov)
8. Gulab D. Identification, Synthesis, and Strategy For Minimization of Potential Impurities Observed In Raltegravir Potassium Drug Substance. Organic Process Research & Development. Volume 16. Issue 8. Pages 1422-1429. 2012.
9. Raltegravir Oral: Uses, Side Effects, Interactions, Pictures, Warnings & Dosing - WebMD
10. Dario Cattaneo. Comparison of the In Vivo Pharmacokinetics and In Vitro Dissolution of Raltegravir in HIV Patients Receiving the Drug by Swallowing or by Chewing. ASM Journals. Antimicrobial Agents and Chemotherapy. Vol. 56, No.12 DOI: <https://doi.org/10.1128/aac.00942-12>.
11. Raltegravir: MedlinePlus Drug Information
12. Raltegravir: Uses, Interactions, Mechanism of Action | DrugBank Online
13. Rambabu Kurchi, K. Balmurali Krishna and Sambasiva Rao. New RP - HPLC Method Development and validation for Analysis of Antiviral drug Raltegravir. Journal of Research in Pharmaceutical and Biomedical Sciences. 2011; Corpus ID: 97688994





Anusha Gandhi et al.,

14. T. Sudha and P. Shanmuga sundram. Development and Validation of RP-HPLC and HPTLC Chromatographic Methods of Analysis for the Quantitative Estimation of Raltegravir Potassium in Pharmaceutical Dosage Form. Research Journal of Pharmacy and Technology. Research J. Pharm. and Tech. 4(11): Nov. 2011; Page 1746-1750.
15. Sonam Patel, Krishnaveni Nagappan, Gouru Santhosh Reddy, Gullapalli Kowmudi. Quantitative Reverse-phase High-performance Liquid Chromatographic Method for the Quantification of Raltegravir Potassium in Bulk and Dosage Forms. J Young Pharm, 2019;11(3):274-278. DOI: 10.5530/jyp.2019.11.55
16. A. Lakshmana Rao and MS. Raghu Ram. Validated Reverse phase HPLC method for Determination of Raltegravir in pharmaceutical preparations International journal of research in pharmacy and chemistry, IJRPC 2012, 2(1). ISSN: 2231–2781
17. T.Sudha, T.Raghupathi. Reverse Phase–High Performance Liquid Chromatography and Ultra Violet Spectrophotometric Method for the Estimation of Raltegravir Potassium in Bulk and in Tablet Dosage form. Global Journal of Medical research. Volume 11 Issue 2 Version 1.0 July 2011. ISSN: 0975-5888
18. Sonam Patel, Krishnaveni Nagappan, Gouru Santhosh Reddy, Gullapalli Kowmudi. Quantitative Reverse-phase High-performance Liquid Chromatographic Method for the Quantification of Raltegravir Potassium in Bulk and Dosage Forms. J Young Pharm, 2019;11(3):274-278.
19. K. Vijaya Sri, S. Ravinderreddy, K. Suresh. Rapid RP-HPLC Method Development and Validation for Analysis of Raltegravir in Bulk and Pharmaceutical Dosage Form. Asian Journal of Research in Chemistry in 2015; 8(5) ; Page 335-339. doi: 10.5958/0974-4150.2015.00055.3

**Table 1: Optimised Chromatographic conditions**

Parameters	Optimized conditions
Column	Enable C18G (250 ×4.6 mm i.d.,5μ)
Flow rate	1.0ml/min
Column	Inertsil - C18, ODS column
Mobile phase	HPLC Water (Required): Acetonitrile + Methanol (30:70)
Detector wavelength	221nm
Column temperature	Ambient
Injection volume	20μl
Run time	11 min
Retention time	4.657 min

**Table 2 : System parameters for Raltegravir potassium**

Parameters	Raltegravir potassium
Retention time	4.657
Tailing factor	1.225
Theoretical plates	5745.319

**Table 3: Calibration curve data for Raltegravir potassium**

S.No	Raltegravir potassium	
	Conc. (μg/ml)	Peak area
1.	20	138541
2.	40	246327
3.	60	341468
4.	80	443219
5.	100	533619





Anusha Gandhi et al.,

6.	120	644712
----	-----	--------

**Table 4: Precision data for Raltegravir potassium**

S.No	Day 1		Day 2	Day 3
	Conc. (µg/ml)	Peak area	Peak area	Peak area
1.	60	341453	342589	346257
2.	60	342784	346581	341259
3.	60	340147	342547	342573
4.	60	343681	349836	342679
5.	60	342692	345687	341258
6.	60	344126	344343	346325
Mean		342480.5	345263.83	343436.83
S.D		3284.3115	2764.147	2395.89
%RSD		0.96%	0.80%	0.69%

**Repeatability (Intraday Precision):**

**Table 5: Precision data for Raltegravir potassium**

S.No	Time interval 1		Time interval 2	Time interval 3
	Conc. (µg/ml)	Peak area	Peak area	Peak area
1.	60	341453	342586	346214
2.	60	342784	341257	347519
3.	60	340147	345789	347651
4.	60	343681	345216	346528
5.	60	342692	348952	347523
6.	60	344126	347581	347596
Mean		342480.5	345230.1667	630.1312297
S.D		3284.3115	2914.399	0.001815
%RSD		0.96%	0.84%	0.18%

**Table 6: Recovery studies for Raltegravir potassium**

Drug	Spike level(%)	Amount taken(µg/ml)	Amount found(µg/ml)	Percent Recovery(%w/w)	Statistical Parameters
Raltegravir potassium (40 µg/ml)	80	32	31.6	98%	Mean :0.98 SD :0.005 %RSD:0.5%
	80	32	31.9	99%	
	80	32	31.5	98%	
	100	40	39.4	98%	Mean :0.98 SD :0.005 %RSD:0.5%
	100	40	39.7	99%	
	100	40	39.2	98%	
	120	48	47.2	98%	Mean :0.98 SD
	120	48	47.5	98%	







Anusha Gandhi et al.,

	120	48	47.3	98%	:0.005 %RSD:0.5%
--	-----	----	------	-----	---------------------

Table 7: Robustness studies of Raltegravir potassium

Modification	Raltegravir potassium	
	220nm	222nm
	345398	344567
	344859	342365
	340342	345986
	346854	340147
	349875	348426
	344140	349513
Mean	345244.667	345167.3333
%RSD	0.9%	1.0%

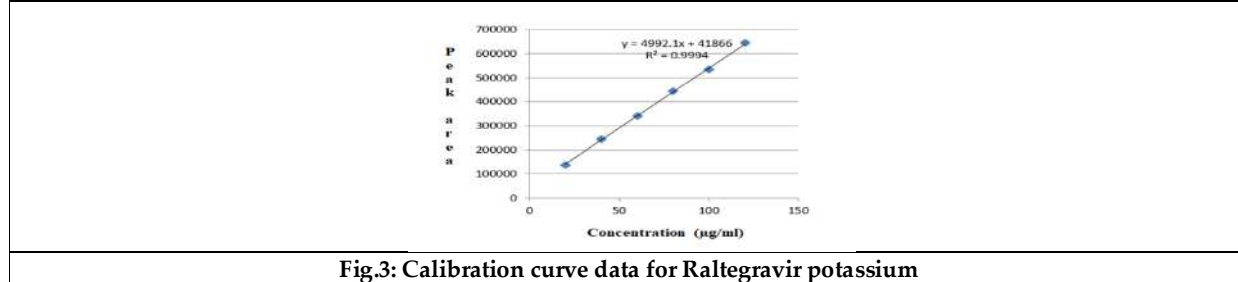
Table 8: Ruggedness studies of Raltegravir potassium

Modification	Raltegravir potassium	
	Analyst 1	Analyst 2
	347536	346398
	345269	344587
	342236	343358
	347745	347795
	342399	343487
	344125	344852
Mean	344885	345079.5
%RSD	0.6%	0.5%

Table 9 : LOD and LOQ data for Raltegravir potassium

Drug	LOD (µg/ml)	LOQ(µg/ml)
Raltegravir potassium	0.101	0.306

<b>Fig. 1: Molecular structure of Raltegravir potassium</b>	<b>Fig. 2 : Optimised chromatogram</b>





## Anaerobic Codigestion of Food Waste for Production of Bioenergy: Review

Poonam Ojha<sup>1</sup>, Sharda Soni<sup>2</sup>, Archana Saxena<sup>3</sup>, Sangeeta Vyas<sup>3</sup>, Vinita Sharma<sup>3</sup>, Anurag Sharma<sup>1</sup> and Swati Joshi<sup>1</sup>

<sup>1</sup>Associate Professor, Department of Chemistry, Swami Keshvanand Institute of Technology, Management and Gramothan, Jaipur, (Affiliated to Rajasthan Technical University), Rajasthan, India.

<sup>2</sup>Head and Associate Professor, Department of Chemistry, Swami Keshvanand Institute of Technology, Management and Gramothan, Jaipur, (Affiliated to Rajasthan Technical University), Rajasthan, India.

<sup>3</sup>Professor, Department of Chemistry, Swami Keshvanand Institute of Technology, Management and Gramothan, Jaipur, (Affiliated to Rajasthan Technical University) Rajasthan, India.

Received: 22 Jan 2024

Revised: 09 Feb 2024

Accepted: 27 Apr 2024

### \*Address for Correspondence

#### Poonam Ojha

Associate Professor,  
Department of Chemistry,  
Swami Keshvanand Institute of Technology,  
Management and Gramothan, Jaipur,  
(Affiliated to Rajasthan Technical University),  
Rajasthan, India.  
Email: pnmojha@gmail.com



This is an Open Access Journal / article distributed under the terms of the **Creative Commons Attribution License** (CC BY-NC-ND 3.0) which permits unrestricted use, distribution, and reproduction in any medium, provided the original work is properly cited. All rights reserved.

### ABSTRACT

A serious issue of food waste and its accumulation is growing along with the global population. Food waste is growing at an exponential rate, which causes a number of problems including health risks, environmental damage, and a shortage of disposal site. The usage of renewable energy sources, energy efficiency, and pollution management are major global concerns today. Thus, we are creating new, remunerative approach for the breakdown and disposal of organic waste. In this context, the biochemical process of breaking complex organic materials into a clean and renewable source of energy in form of biogas is gaining a lot of interest in terms of food wastes management, energy, and nutrient production. Thus in this way it also helps the society to overcome a big issue of managing the solid waste and thus reduces environmental pollution. Generally, solid waste management focuses only on working towards disposal options of solid wastes rather than treatment of waste for recovering of energy. In this review I have shown various methods of codigestion of food wastes for effective generation of bioenergy and thereby reducing a big problem associated with disposal and treatment of food wastes for protection of environment.





Poonam Ojha et al.,

**Keywords:** Food waste, Codigestion, Bioenergy, Environmental Pollution, Solid Waste Management

## INTRODUCTION

Although food stocks obtained from food waste disposal sites are powerful energy sources. But bulk solid waste is dumped in landfills and left to break down naturally. This releases a great deal of methane and other greenhouse gases into the environment. Although fruit and vegetable waste are readily biodegradable on their own as they have higher water content. And such waste with high nutritional worth is best digestible through anaerobic digestion [1] Co-digestion, actually refers to simultaneous treatment and digestion of two or more organic biodegradable wastes. This approach provides a first-rate procedure for handling and properly disposing of municipal solid waste. Anaerobic digestion was traditionally done using a single substrate. Traditionally, it is used to break down household sludge, but with the addition of co-substrates, it now has an antagonistic effect on the digestive process and increases the yield of biogas [2]. Anaerobic activities of many different kinds are used in the digesting process. Literature makes it abundantly evident that different wastes are processed in the same digester that breaks down municipal sewage sludge. When extracted from landfills as leachate, organic fraction of municipal solid waste—also referred to as OFMSW, are properly managed. Anaerobic codigestion is used in many nations to dispose of OFMSWs because it is thought to be the best method for handling this kind of situation. Vegetable waste from food processing, including plant and agricultural waste, is proven to be highly biodegradable and can be broken down using an anaerobic co-digestion system. Their large proportion of easily biodegradable COD (chemical oxygen demand) enhances the anaerobic system's efficacy [3]. Numerous methods, including single- and multi-stage treatment processes for different food residues, have been investigated. Wastes from restaurants and cafeterias, such as fruits, vegetables, and cereals, are homogenized and ground up before being used in a lab to create bio hydrogen or methane, which can be used to generate energy [4,5]. According to Zitomer et al. adding brewing yeast extract to a waste water treatment facility can boost the biogas output [6].

Trace elements such as Co, Fe, and Ni improve not only the biogas yield but also the food digestion's dewatering capacity and the final biosolids' stabilization. Co-digestion is a common way to improve the production of biogas as compared with existing facilities that process a single waste stream [7]. Utilizing wastewater treatment equipment to treat both liquid and solid waste together is more advantageous financially [8]. Because municipal wastewater sludge has a low solids content, a lesser ratio of C/N and little nutritional value, co-digestion can be a advantageous method for their treatment. Additionally, these parameters are frequently optimized when co-substrate is added. Ohio produces biogas by the codigestion of yard scrap with waste material from Wal-Mart food outlet [9]. In a Spanish study, home wastewater sludge, industrial waste, and agricultural waste were all co-digested. Fruit and vegetable wastes were among the food wastes used in this investigation [10]. Sewage sludge and meat industry wastes are combined for digestion. Analogous studies were conducted in Spain to examine the effects of incorporating waste gathered from butchery into anaerobic digesters that employ sewer water matter. This waste consisted of a mixture of cattle and pig excretion as well as leftover meat slurries from the animals [11]. The same study used OFMSWs in co-digestion operations with wastes from slaughterhouses and poultry processors [12]. Anaerobic digestion has long used manure as a feed source. Numerous initiatives in developing nations (like India) use cow dung to provide biogas to rural areas with an excessive number of livestock. In Mexico, separate co-digestion of cow dung, waste obtained by cotton seeds with high fat content with municipal sewage sludge was done in anaerobic systems [13]. Manure is mixed with accumulated solid food processing waste, such as dairy waste mixtures and waste from potato chips. Research on the co-digestion of cheese waste and cattle manure has been conducted in Italy utilizing a two-stage procedure [14]. Additionally, waste glycerol from the bio diesel manufacturing process is co-digested with waste sludge obtained from municipal waste disposal sites. Since glycerol is an easily perishable matter for anaerobic co-digestion, it aids in the sustainable bio fuel industry's efforts to address a major waste disposal issue [15].





Poonam Ojha *et al.*,

### PHYSICAL PARAMETERS

Certain physical characteristics in the anaerobic co-digestion process can increase the degradation system's efficiency. Certain parameters are required to control these digester characteristics and speed up the growth of microorganisms:

#### Temperature

The chemical and physical characteristics of the digester's contents are correlated with temperature. It also has an impact on the digestion process's kinetic and thermodynamic conditions. In addition to helping to provide ideal digestive conditions and a high methane content, temperature is a thermophilic substance.

#### Volatile solids

The waste composition employed in anaerobic co-digestion includes complex organic waste portion, ignitable portion, and sluggish portion. Vegetable and food waste from houses could make up the decomposition component. The section that can catch fire consists of cardboard and wood paper. Wastes such as metallic components, soil, rock materials, glass, etc. may be found in the inert section. These are also included in waste to energy treatment technology.

#### pH level

varying microbes require varying pHs throughout the anaerobic digesting process. The ideal pH range is between 5.5 and 8.5. While acidogenic bacteria prefer a pH of over archeobacteria bacteria that require a pH of 6.2 to work.

#### Ammonia

Ammonia works in two forms: non-ionized ammonia and ammonium. The cause of inhibition is non-ionized ammonia, or  $\text{NH}_3$ . The degree of ionization is determined by the pH value, which has a significant impact on ammonia inhibition.

#### Basic media

An alkaline medium is necessary to keep a digester stable. It has to do with the digester's hydroxide, bicarbonate, and carbonate contents. It balances the digester's acidity and aids in preserving buffering capacity. Bicarbonate is the primary carbon source for methane-forming bacteria.

#### Sulphide

In anaerobic digesters, sulphate is biologically converted to sulphide. If the sulphide content exceeds 250 mg/l. It messes with the digestive system [16].

#### Nutrients

Metals like as iron, nickel, and cobalt, among others, are crucial in promoting the best possible bacterial growth and methane production [17]. Metals such as aluminum, manganese, boron, molybdenum, and selenium are recommended as additional components for anaerobic digesters [18].

#### Carbon to nitrogen ratio

This ratio indicates how much amount of carbon and nitrogen content are present in the substrate. Ammonia production will be inhibited by a lower carbon to nitrogen ratio [19]. A high carbon to nitrogen ratio suggests that methanogenic microorganisms use nitrogen quickly. Carbon to nitrogen ratio should be in the range of 25 to 30 and it can be achieved by co-digestion of different categories of waste materials.

#### Solids content

Digesters of anaerobic codigestion assembly contain amount of total solids content lower than 12 %, medium solids between 20% to 25% and high solids within the range 30% - 40%. It is represented as weight of total organic matter with respect to volume of digester upon time [20]. Feedstock is organic waste that, during the anaerobic digestion

73767





Poonam Ojha et al.,

process, microbes convert to methane. The elements carbon, nitrogen, oxygen, hydrogen, phosphorus, and sulfur make up the majority of organic wastes. Lower gas production results from nitrogen depletion, which happens when the carbon to nitrogen fraction is higher.

### Mixing

New influents are combined with the contents of an existing digester. It keeps the temperature varied and prevents the growth of slime. The purpose of mixing and blending is to keep the sludge homogeneous and to minimize scum deposition. Slow mixing facilitates the activity of microorganisms in digesters as well. It disperses harmful substances to reduce toxicity.

### Compost

Organic material that has broken down in digesters is called compost. Slurry-like liquid portion is taken out of the digester and recycled back into the reactor. Compost is created and can be utilized as fertilizer when the solid component is maintained apart in the form of a long pile. The content of trash determines the standard and quality of compost.

**Bye- Products:** During the procedure, the following byproducts are created:

### Biogas

One significant byproduct of anaerobic co-digestion is biogas. When the intermediate digestion phase is completed, the maximum amount of biogas is produced. Methane, CO<sub>2</sub>, and trace amounts of hydrogen and sulfide are among its constituents. Biogas is typically kept in expandable gas bubbles on top of the digester.

### Wastewater

When the liquid portion is separated from the digestate, wastewater is produced. The anaerobic digester's liquid waste has elevated BOD and COD values. Prior to discharge, it needs to have more treatment.

### Digestate

Digestate are solid waste digesters that are incapable of being broken down by microbes. They also have dead bacterias. Digestate comes in three different forms: liquid, fiber, or a two-fraction mixture of sludge.

## ADVANTAGES

This approach has numerous benefits since it treats organic waste and substrate jointly, which lessens the amount of solid waste that needs to be handled. Additionally, treating waste while simultaneously breaking down the substrate improves the digesting system's nutrient balance. As a result, biogas is produced, renewable biomass is disposed of for agricultural digestion, and soil conditioners are used as fertilizers. It eliminates germs by maintaining a sustained temperature. Additionally, it lowers gas emissions through methane recovery.

## DISADVANTAGES

This system has certain drawbacks, such as the need for expertise in design, building, and maintenance. It raises the need for pre-treatment as well as COD and BOD effluents.

## CONCLUSION

Anaerobic Co-digestion processes that combine wastewater or dairy digesters with high buffering capacity with high energy content organic waste products (such as fats, oils, and grease, or FOG) have the potency to create large amounts of biogas, or methane. Additionally, it lessens the problem of food waste and FOG being dumped in public sewer systems and landfills. Co-digestion prevents volatile fatty acidification, balances nutrients, and increases pH

73768





Poonam Ojha et al.,

buffering capacity. It was observed that co-digestion of mixed wastes had a beneficial effect on the amount and quality (CH<sub>4</sub> concentration) of biogas in addition to producing better methane gas yields when compared to single waste digestions. It is the outcome of a beneficial interplay between increased nutrient supply and digestion. Co-digestion can have financial benefits since it uses common instrumentation, makes processing of staple easier, and produces a more lasting method overall. The biggest drawback for this technique to gain attention is requirement of increased research, study and feasible methods this technique till date in our country.

## REFERENCES

1. Zhang, R., Elmashad, H., Hartman, K., Wang, F., Liu, G., Choate, C., & Gamble, P. (2007). Characterization of food waste as feedstock for anaerobic digestion. *Bioresource Technology*, 98(4), 929-935. doi:10.1016/j.biortech.2006.02.039.
2. Bhatt, A. H., & Tao, L. (2020). Economic perspectives of biogas production via anaerobic digestion. *Bioengineering*, 7(3), 74.
3. Ağdağ, O. N., & Sponza, D. T. (2005). Effect of alkalinity on the performance of a simulated landfill bioreactor digesting organic solid wastes. *Chemosphere*, 59(6), 871-879. doi:10.1016/j.chemosphere.2004.11.017
4. Pahl-Wostl, C., Craps, M., Dewulf, A., Mostert, E., Tabara, D., & Taillieu, T. (2007). Social learning and water resources management. *Ecology and Society*, 12(2). doi:10.5751/es-02037-120205.
5. Habiba, L., Hassib, B., & Moktar, H. (2009). Improvement of activated sludge stabilisation and filterability during anaerobic digestion by fruit and vegetable waste addition. *Bioresource Technology*, 100(4), 1555-1560. doi:10.1016/j.biortech.2008.09.019.
6. Zitomer, D. H., Adhikari, P., Heisel, C., & Dineen, D. (2008). Municipal anaerobic digesters for Codigestion, energy recovery, and greenhouse gas reductions. *Water Environment Research*, 80(3), 229-237. doi:10.2175/106143007x221201
7. Zupančič, G. D., Uranjek-Ževart, N., & Roš, M. (2008). Full-scale anaerobic Co-digestion of organic waste and municipal sludge. *Biomass and Bioenergy*, 32(2), 162-167. doi:10.1016/j.biombioe.2007.07.006
8. Hamzawi, N., Kennedy, K. J., & McLean, D. D. (1998). Anaerobic digestion of Co-mingled municipal solid waste and sewage sludge. *Water Science and Technology*, 38(2), 127-132. doi:10.2166/wst.1998.0121
9. Brown, D., & Li, Y. (2013). Solid state anaerobic Co-digestion of yard waste and food waste for biogas production. *Bioresource Technology*, 127, 275-280. doi:10.1016/j.biortech.2012.09.081
10. Astals, S., Esteban-Gutiérrez, M., Fernández-Arévalo, T., Aymerich, E., García-Heras, J., & Mata-Alvarez, J. (2013). Anaerobic digestion of seven different sewage sludges: A biodegradability and modelling study. *Water Research*, 47(16), 6033-6043. doi:10.1016/j.watres.2013.07.019.
11. Buendía, I. M., Fernández, F. J., Villaseñor, J., & Rodríguez, L. (2009). Feasibility of anaerobic Co-digestion as a treatment option of meat industry wastes. *Bioresource Technology*, 100(6), 1903-1909. doi:10.1016/j.biortech.2008.10.013
12. Cuetos, M. J., Gómez, X., Otero, M., & Morán, A. (2008). Anaerobic digestion of solid slaughterhouse waste (SHW) at laboratory scale: Influence of Co-digestion with the organic fraction of municipal solid waste (OFMSW). *Biochemical Engineering Journal*, 40(1), 99-106. doi:10.1016/j.bej.2007.11.019
13. Macías-Corral, M., Samani, Z., Hanson, A., Smith, G., Funk, P., Yu, H., & Longworth, J. (2008). Anaerobic digestion of municipal solid waste and agricultural waste and the effect of Co-digestion with dairy cow manure. *Bioresource Technology*, 99(17), 8288-8293. doi:10.1016/j.biortech.2008.03.057
14. Bertin, L., Grilli, S., Spagni, A., & Fava, F. (2013). Innovative two-stage anaerobic process for effective codigestion of cheese whey and cattle manure. *Bioresource Technology*, 128, 779-783. doi:10.1016/j.biortech.2012.10.118
15. Athanasoulia, E., Melidis, P., & Aivasidis, A. (2012). Optimization of biogas production from waste activated sludge through serial digestion. *Renewable Energy*, 47, 147-151. doi:10.1016/j.renene.2012.04.038
16. Metcalf, L., Eddy, H. P., & Tchobanoglous, G. (1991). Wastewater engineering: Treatment, disposal, and reuse.





**Poonam Ojha et al.,**

17. Speece, R. E. (1983). Anaerobic biotechnology for industrial wastewater treatment. *Environmental Science & Technology*, 17(9), 416A-427A. doi:10.1021/es00115a001
18. Azbar, N., Ursillo, P., & Speece, R. E. (2001). Effect of process configuration and substrate complexity on the performance of anaerobic processes. *Water Research*, 35(3), 817-829. doi:10.1016/s0043-1354(00)00318-3
19. Maya-Altamira, L., Baun, A., Angelidaki, I., & Schmidt, J. (2008). Influence of wastewater characteristics on methane potential in food-processing industry wastewaters. *Water Research*, 42(8-9), 2195-2203. doi:10.1016/j.watres.2007.11.033
20. Azbar, N., Ursillo, P., & Speece, R. E. (2001). Effect of process configuration and substrate complexity on the performance of anaerobic processes. *Water Research*, 35(3), 817-829. doi:10.1016/s0043-1354(00)00318-3





## Herbs used for Otradam (Fomentation Therapy) Mentioned in Siddha Literature – A Review

J.Lavanya<sup>1\*</sup>, R.Subhashri<sup>1</sup>, D.Periyasamy<sup>2</sup> and M.V.Mahadevan<sup>3</sup>

<sup>1</sup>PG Scholar, Department of Puramaruthuvam, National Institute of Siddha, (Affiliated to The Tamil Nadu Dr. M.G.R. Medical University) Chennai, Tamil Nadu, India.

<sup>2</sup>Associate Professor, Department of Puramaruthuvam, National Institute of Siddha, (Affiliated to The Tamil Nadu Dr. M.G.R. Medical University) Chennai, Tamil Nadu, India.

<sup>3</sup>Associate Professor and HoD, Department of Puramaruthuvam, National Institute of Siddha, (Affiliated to The Tamil Nadu Dr. M.G.R. Medical University) Chennai, Tamil Nadu, India.

Received: 22 Jan 2024

Revised: 09 Feb 2024

Accepted: 27 Apr 2024

### \*Address for Correspondence

**J.Lavanya**

PG Scholar,

Department of Puramaruthuvam,

National Institute of Siddha,

(Affiliated to The Tamil Nadu Dr. M.G.R. Medical University)

Chennai, Tamil Nadu, India.

Email: jclkasilingam1022@gmail.com



This is an Open Access Journal / article distributed under the terms of the **Creative Commons Attribution License** (CC BY-NC-ND 3.0) which permits unrestricted use, distribution, and reproduction in any medium, provided the original work is properly cited. All rights reserved.

### ABSTRACT

Siddha system of medicine is one of the ancient system of medicine which is widely practiced in southern parts of India. *Otradam* (Fomentation therapy) is one of the external treatment modalities which is traditionally practiced. A wide variety of plants are most frequently utilized in *Otradam*. The knowledge of these plants is scattered in various siddha literatures; hence this review was carried out to collect the information of various plants used for this therapy. Literature search was done from various Siddha literatures available in the Library of National Institute of Siddha. According to the findings, 45 Siddha texts provide herbal formulations of *Otradam* (Fomentation therapy) which will provide an elaborative knowledge on various plants used for this therapy.

**Keywords:** Siddha medicine, External therapy, *Otradam*, medicinal plants.







Lavanya et al.,

## INTRODUCTION

Siddha medicine is a centuries-old system of medicine that teaches the concepts required for a disease-free existence and illness prevention. The two therapy strategies employed to treat the disorders are *agamarundugal* (internal medicines) and *puramarundugal* (external medicines) (1)(2). *Otradam* (Medicated fomentation) is a type of *Agni* procedures (3) in which bolus is made with anyone or combination of materials such as leaves, barks, pulses, cereals, husks, lime, brickpowder etc., which are tied in a muslin cloth to make pouches, then heated to a particular temperature and applied on the affected area [1][2]. In fomentation therapy, the body is exposed to varying intensities and qualities of heat which results in sweating. This helps to disperse aggravated *thodams* in the affected area and dilating all body channels for cleansing [4]. Siddhar *Theraiyar* in the text *Theraiyar Tharu* mentioned that fomentation when applied to the forehead, mouth, ear, nose, abdomen, spinal region, shoulder, sole, vertex, umbilical, intercostal, lumbosacral and pelvic girdle helps to relieve pain caused due to vitiated *Vatham* [3]. Leaves of *Vitex negundo* (*Notchi*), *Calotropis gigantea* (*Erukku*), *Clerodendrum phlomidis* (*Thazhuthalai*), *Ricinus communis* (*Amanakku*), *Abutilon indicum* (*Thutti*) and *Bacopa Monnieri* (*Brahmai*), Powder of *Curcuma longa* rhizome (*Manjal*), Salt (*Uppu*), Ashes of egg shell (*Muttai oodu*), *Dolichos biflorus* (*Kollu mavu*), *Trachyspermum ammi* (*Omam*), Paddy husk, black stone powder, Brick powder and slime are commonly used materials for *Otradam* (Fomentation therapy) [3]. Though these are the most commonly used materials for this therapy there are various other herbals indicated in the Siddha literatures, as these knowledges are scattered in various texts, its usage for treating various conditions are becoming extinct among the Siddha practitioners, hence this review article aims at collecting various herbals, their parts used, along with its indications, mentioned in various Siddha literatures for *Otradam* (Fomentation therapy).

## METHODS AND MATERIALS

A detailed literature search was done in the library of National Institute of Siddha for formulations of *Otradam* (Fomentation therapy) codified in the Siddha literatures. Among the available formulations, herbal formulations found in those literatures were identified and analyzed. The findings were categorized depending upon their parts used, indications, and the family to which each herbals belong. MS word software was used for organizing and analyzing data.

## RESULTS

Polyherbal formulations are commonly used in *otradam* (fomentation therapy) to treat various diseases. The plants used in those polyherbal formulations were categorized based on the parts used such as seeds, roots, leaves, flowers and barks along with their botanical name, vernacular name and indications. The list of Seeds, roots, leaves, flowers and barks used for *Otradam* (Fomentation therapy) are listed in Table No: I, Table No:II, Table No:III, Table No:IV and Table No:V respectively.

## DISCUSSION

The collected data shows that, totally 45 Siddha literatures have herbal formulations of *Otradam* (Fomentation therapy). Among them, 9 books are in the name of Siddhar *Agathiyar*, 6 books are from the *Sarabendar* series of books, 3 books are in the name of *Siddhar Brahmanuni*, 2 books are in the name of *Siddhar Theraiyar*, 1 book in the name of *Siddhar Yuginuni* and 24 books are not titled in the name of any Siddhars. The collected data showed that 20 types of seeds, 22 types of roots, 46 types of leaves, 5 types of flowers and 10 types of barks are been used for *Otradam* (Fomentation therapy) in the management of various conditions. These 20 type of seeds belong to the families of *Alangiaceae*, *Brassicaceae*, *Calophyllaceae*, *Euphorbiaceae*, *Fabaceae*, *Leguminaceae*, *Loganiaceae*, *Lythraceae*, *Malvaceae*, *Marsilaceae*, *Meliaceae*, *Moringaceae*, *Papilionaceae*, *Sapotaceae*, *Solanaceae* and *Zingiberaceae*. They were mostly indicated





### Lavanya et al.,

for the treatment of diseases caused due to the derangement of *Vathathodam* (Diseases caused due to vitiated *Vatha* humour), *Sanni* (Diseases caused due to imbalance of 3 humours), *Paambu kadi* (Sanke bite) etc., The 22 types of roots collected shows that they belong to the families of *Alangiaceae*, *Apocynaceae*, *Aristolochiaceae*, *Asclepiadaceae*, *Aspodelaceae*, *Capparaceae*, *Euphorbiaceae*, *Fabaceae*, *Lamiaceae*, *Loganiaceae*, *Malvaceae*, *Phyllanthaceae*, *Plumbaginaceae*, *Poaceae*, *Rutaceae*, *Salvadoraceae* and *Solanaceae*. They were mostly indicated for the treatment of *Vidam* (Poisonous bites), *Sanni* (Diseases caused due to imbalance of 3 humours), *Pungal* (Ulcers) and *Kan Noigal* (Eye diseases). The 46 types of leaves used, belong to the families of *Acanthaceae*, *Alangaiceae*, *Amaranthaceae*, *Apocynaceae*, *Asteraceae*, *Boraginaceae*, *Caesalpiniaceae*, *Capparaceae*, *Cucurbitaceae*, *Euphorbiaceae*, *Fabaceae*, *Loganiaceae*, *Malvaceae*, *Melastomataceae*, *Meliaceae*, *Menispermaceae*, *Moraceae*, *Moringaceae*, *Nyctaginaceae*, *Papaveraceae*, *Rutaceae*, *Sapindaceae*, *Sapotaceae*, *Solanaceae* and *Vitaceae*. They were indicated for the treatment of various types of *Vatha noigal* (disease caused due to vitiated *Vatha* humour) such as *Sandu vatham*, *kuthikaalvatham* etc., and *Kan Noigal* (Eye diseases). Furthermore, the flowers used for *Otradam* belong to the family of *Apocynaceae*, *Asclepidaceae*, *Clusiaceae*, *Fabaceae* and *Moringaceae*. They are used in the treatment of conditions such as *Sanni* (Diseases caused due to imbalance in 3 humours), *Pungal* (Ulcer) and *Andavayu* (Hydrocele).

Finally, the 10 types of barks used, belong to the family of *Apocynaceae*, *Capparaceae*, *Combretaceae*, *Fabaceae*, *Meliaceae*, *Moraceae*, *Moringaceae*, *Myrtaceae* and *Rhamnaceae*. They are indicated for the treatment of different type of *Sanni* (Diseases caused due to imbalance in 3 humours), *Kan Noigal* (Eye diseases), *Pungal* (Ulcers) and *Moolam* (Haemorrhoids). The majority of the medicinal plants (33 plants) utilised for *Otradam* (fomentation treatment) are from these families, such as *Fabaceae*, *Apocynaceae*, *Euphorbiaceae*, and *Lamiaceae*, and it should be evaluated further. Though *Otradam* (Fumigation therapy) is indicated for the treatment of wide range of conditions, most of them are used in the management of *Vatha Noigal* (caused due to vitiated *Vatham*), *Kan noigal* (Eye diseases) and *Vidam* (Poisonous bites). Furthermore, among the observed parts used in the *Otradam* (Fumigation therapy), leaves accounts to be used extensively in management of various conditions, the scientific reasoning of its extensive use in this therapy still remains unexplained but may be attributed to its ease of availability and potent pharmacological actions. This review contains elaborative detailing of various plants, its parts used, vernacular name, family and indications used for *Otradam* (Fomentation therapy) mentioned in various Siddha literatures. This may act as evidence for further experimental studies in this treatment modalities and clinical practices in the future.

## REFERENCES

1. R.Thiyagarajan, Gunappadamthaathuseevavaguppu, 8<sup>th</sup> edition, Department of Indian medicine and homeopathy, Chennai.
2. Siddhar Aruvai Maruthuvam, K.S. Uthamarayan, Sixth edition 2013, Page no 45, Department of Indian Medicine and Homeopathy
3. K.S.Uthamarayan, Siddha maruthuvaangasurukkam, 2<sup>nd</sup> edition 1983, Department of Indian medicine and homeopathy, Chennai.
4. Dr.G.Senthilvel, Dr.J.Jeyavenkatesh, A complete manual of Siddha External Therapy, 2017, Shanlax publications
5. S.P.Ramchandran, Agathiyarpallu 200, 2000, Thamarai noolagam, Chennai.
6. Dr.S.Venkatrajan, Agathiyar 2000 part 3, Director, 2007, Saraswathi mahal library.
7. Uthaya vendhan, Agathiyararuliyaayulvedham, 2012.
8. S.P.Ramchandran, Agathiyarayulvedham 1200, 1999, Thamarai noolagam, Chennai 26.
9. Dr.S.Prema M.D(s), Agathiyar mani 4000 ennum Vaithiyasinthamanivenba 4000 part 1, 1996, Tamarai noolagam, Chennai.
10. Dr.S.Prema M.D(s), Agathiyar mani 4000 ennum Vaithiyasinthamanivenba 4000 part II, 2006, Tamarai noolagam, Chennai.
11. Dr.Aanaivarianandhan, Agathiyar maruthuvam, 2009, Department of Indian medicine and homeopathy, Chennai
12. S.P.Ramchandran, Agathiyar vaithiyasadhagam, 2000, Thamarai noolagam, Chennai 26.
13. V.R.Madhavan, Agathiyar vaithiyasinthamani 4000, 2003, Tamil university, Tanjore.





## Lavanya et al.,

14. A.KrishanasamiMaadik Raav sahib, Sarapenthiravaithiyamuraigalmaaladugal, kuthiraigal, paravaigallakshanangalum, vaithiyamum, 2003, Director, Saraswathi mahal library.
15. T.S.Amirthalingam Pillai, Dr.S.Venkatrajan, Sarapenthiravaithiya muraigalnayanarohasihichai, 1998, Director, Saraswathi Mahal Library, Tanjore.
16. Dr.V.G.Chandran, Dr.Nalini Chandran, Sarapenthiravaithiyamuraigalsannirohasihichai, 2006, Director, Saraswathi Mahal Library, Tanjore.
17. T.S.Amirthalingam Pillai, Dr.S.Venkatrajan, Sarapenthiravaithiyamuraigaloolai, Moola, Kusta, pith rohamuraikal, 1998, Director, Saraswathi Mahal Library, Tanjore.
18. K.Vasudhevasastri,Sarapenthiravaithiyamuraigalvaadharohasihichai, 2014, Director, Saraswathi Mahal Library, Tanjore.
19. Dr.S.Venkatarajan,Sarapenthiravaithiyamuraigalvisharohasihichai, 2005, Director, Saraswathi Mahal Library, Tanjore.
20. R.C.Mohan,Brammamunimaruthuvavilakkam 2005, Thamaainoolagam, Chennai.
21. Dr.K.Maruthamuthu, Brammamunivaithiyasoothiram part 1, 2005, Director, Saraswathi mahal library, Tanjore.
22. Dr.K.Maruthamuthu, Brammamunivaithiyasoothiram part 2, 2006, Director, Saraswathi mahal library, Tanjore.
23. T.Azhagpparasu, S.R.Prasanna, Therayarvaithiyakaaviyam, 2012, Department of Indian medicine and homeopathy, Chennai.
24. Therayar Yamaha venba
25. Yugimunivaithiyakaaviyam
26. Dr.C.N.Kuppusamy, Dr.V.S.Parvathy Anupava vaithiyamurai part 3, 1951, Government oriental manuscripts and research centre, Chennai
27. Dr.C.N.Kuppusamy, Anupava vaithiyamurai part 4, 1962, Government oriental manuscripts and research center, Chennai
28. HakkemP.Mohammedabdulla sahib, Anubogavaithiyavanaveetham part 10, 2002, Thamarai noolagam, Chennai.
29. Dr.S.Aranganathan, Attavanaivaagadam, 2007, Director, Saraswathi mahal library, Tanjore.
30. Munisamy muthaliyar, Kanvaithiyamennumthirunethirasinthamani, 2008, Thirumagal vilasa press, Chennai.
31. S.P.Ramachandran, Mega nivaranabothiniennumneerizhivunoimaruthuvam, 1998, Thamarai noolagam, Chennai.
32. Pandit.K.S.Murugesamudhaliyar, Nanjumurivunool, 2005, Department of Indian medicine and homeopathy, Chennai.
33. Neerizhivumaruthuvam
34. Shanmugananthasvamigal, Noi neekumthailangalseimuraigal, 1986, The hindu publications, Chennai 17.
35. Dr.T.Mohanraj, sanni, vaisoori, paithiyam, kuttammatrumoozhinoithoguthi, 2009, A.T.S.V.S. Siddha medical college and hospital, Kanyakumari
36. Kannusampillai, Sihicharathnadeepamirandambahamiyavaithiyasinthamani, 2007, rathnanayakkar and sons
37. Sirorathinavaithiyabooshanam
38. Dr.K.P.Putparasu, Dr.Salinmanokar, Thamizhmaruthuvam, 2014, Ravanan pathipagam, Kanyakumari.
39. S.P.Ramachandran, Athmarachamirthamennumvaithiyasaarasangiraham, 2000, Thaarainoolagam, Chennai - 26.
40. S.P.Ramachandran, Visha vaithiyaaarudanoolgal, 2000, Thamarai noolagam, Chennai.
41. Dr.T.Mohanraj, Maruthuvaasiriyam, 2008, A.T.S.V.S. Siddha medical college and hospital, Kanyakumari
42. I.Ponnaiyahpillai, Pararasasegaram part 1, 2016, Mahana suthesamaruthuvathinaikalagam, vada mahanasabai
43. I.Ponnaiyahpillai, Pararasasegaram part 5, 2016, Mahana suthesamaruthuvathinaikalagam, vada mahanasabai
44. I.Ponnaiyahpillai, Pararasasegaram part 7, 2016, Mahana suthesamaruthuvathinaikalagam, vada mahanasabai
45. Dr.T.Mohanraj, Bala aasiriyam&Balavagadaaasiriyam, 2009, A.T.S.V.S. Siddha medical college and hospital, Kanyakumari
46. Dr.T.Mohanraj, Tharalamanibalavaagadam, 2009, A.T.S.V.S. Siddha medical college and hospital, Kanyakumari
47. Dr.K.P.Putparasu, Dr.P.Salinmanogor, Thamizh maruthuvam, 2014, Ravanan Pathippagam, Kanyakumari - 63
48. S.P.Ramachandran, Koshayianubogavaithiyabrammarahasiyam part 1, 1996, Thamarai noolagam, Chennai.
49. S.P.Ramachandran, Koshayianubogavaithiyabrammarahasiyam part 2, 1999, Thamarai noolagam, Chennai.
50. T.V.Sambasivampillai dictionary, Volume I,II, Research Institue of Siddhars Science, 1938 Volume III, IV, V The Directorate of Indian Medicine 1977 & 1978.





Lavanya et al.,

Table 1: Seeds used Forotradam (Fomentation Therapy)

S. No	Plant name	Botanical name	Family name	Indication
1.	Azhinjil	Alangiumsalvifolium	Alangiaceae	Mugavaathasanni, sannii, Vaatham <sup>9,16</sup>
2.	Kaduku	Brassica juncea	Brassicaceae	Vaatham <sup>9</sup>
3.	Punmai	Calophylluminophyllum	Calophyllaceae	Santhuvaatham, mugavaathasanni, sannii, Vaatham <sup>9, 18, 16, 41</sup>
4.	aamanakku	Ricinus communis	Euphorbiaceae	Sanni, Arputha vayu, Vaatham, Suram <sup>6, 9, 10, 28, 41</sup>
5.	Pungu	Pongamia glabra	Fabaceae	Mugavaathasanni, sannii, Vaatham <sup>9</sup>
6.	Agathi	Sesbania grandifolia	Fabaceae	Sanni, Vaatham <sup>10, 16</sup>
7.	Sanappu	Crotalerviajuncea	Fabaceae	Sanni, Vaatham <sup>10</sup>
8.	Kazharchi	Caesalpinia bonduc	Fabaceae	Vaatham <sup>8,39, 16</sup>
9.	Kozhiyavarai	Canavalia ensiformis	Leguminosae	Santhuvaatham <sup>18</sup>
10.	Thetran	Strychnuspotatorum	Loganiaceae	Sanni <sup>8, 20</sup>
11.	Maruthani	Lawsoniainermis	Lythraceae	Vaatham <sup>9</sup>
12.	Paruthi	Gossypium herbaceum	Malvaceae	Santhuvaatham, Sanni, Vaatham <sup>9, 16,18</sup>
13.	Araikeerai	Marsilea quadrifolia	Marsileaceae	Vaatham <sup>9</sup>
14.	Vembu	Azhadiracta indica	Meliaceae	Seetham, sannii, Mugavaathasanni, vaatham, Santhuvaatham <sup>18, 41, 35</sup>
15.	Murungai	Moringa oleifera	Moringaceae	Sanni, Vaatham <sup>9</sup>
16.	Palasu	Butea frondose	Papilionaceae	Paambuvidam <sup>32</sup>
17.	Magizham	Mimosopselangi	Sapotaceae	Santhuvaatham, vaatham <sup>9</sup>
18.	Iluppai	Madhuca longifolia	Sapotaceae	Vaatham <sup>41</sup>
19.	Umathai	Datura metel	Solanaceae	Sanni <sup>16</sup>
20.	Arathai	Alpinia galanga	Zingiberaceae	Vaatham <sup>35</sup>

Table.2.Roots used for Otradam(Fomentation Therapy)

S. No	Plant name	Botanical name	Family name	Indication
1.	Azhinjil	Alangiumsalvifolium	Alangiaceae	Vidam <sup>40</sup>
2.	Erukku	Calotropis gigentia	Apocynaceae	Sanni, vidam <sup>40</sup>
3.	Alari	Nerium oderum	Apocynaceae	Nayana pirisal <sup>15</sup>
4.	Nannari	Hemidesmus indicus	Apocynaceae	Pungal <sup>6, 14</sup>
5.	Kerudakodi	Aristolochia indica	Aristolochiaceae	Manadai vali <sup>45</sup>
6.	Uthamani	Pergulariadaemia	Asclepiadaceae	Vidam <sup>32</sup>
7.	Katralai	Aloe indica	Asphodelaceae	Vidam <sup>32, 40</sup>
8.	Sengathari	Capparis aphylla	Capparaceae	Marana vaatham, vidam <sup>29, 32, 40</sup>
9.	Nalvelai	Cleome viscosa	Capparaceae	Vidam <sup>40</sup>
10.	Thirukukalli	Euphorbia tortilis	Euphorbiaceae	Vali vaatham <sup>29</sup>
11.	Kuppaimeri	Acalypha indica	Euphorbiaceae	Sanni, vidam <sup>40</sup>
12.	Avuri	Indigo fertinctour	Fabaceae	Marana vaatham, vidam <sup>29, 32, 40</sup>
13.	Vaagai	Albizia lebbeck	Fabaceae	Vidam <sup>40</sup>
14.	Thumbai	Leucas aspera	Lamiaceae	Oozhi noi <sup>38</sup>
15.	Etti	Strychnosnux-vomica	Loganiaceae	Vidam <sup>40</sup>
16.	Ilavam	Bombax ceiba	Malvaceae	Kurangu kadi <sup>32</sup>
17.	Nelli	Phyllanthus emblica	Phyllanthaceae	pitha pishyantham <sup>15</sup>
18.	Kodiveli	Plumbago indica	Plumbaginaceae	Arayappu <sup>38</sup>
19.	Ilamicham	Antropogengaromaticus	Poaceae	Moolam <sup>17</sup>





Lavanya et al.,

20.	Vilvam	Aegle marmelos	Rutaceae	Kan noi, vidam <sup>40</sup>
21.	Sangam	Azema tetracantha	Salvadoraceae	Vidam <sup>40</sup>
22.	Umathai	Datura metel	Solanaceae	Vidam <sup>40</sup>

Table.3. Leaves used for Otradam (Fomentation Therapy)

S. No	Plant name	Botanical name	Family name	Indication
1.	Adathodai	Justicia beddomei	Acanthaceae	Sanni, Veekam, Varmakaayam, pain <sup>38, 40</sup>
2.	Azhinjil	Alangiumsalvifolium	Alangiaceae	Sagala viriyan kad <sup>40</sup>
3.	Ponnanganni	Alternanthera sessilis	Amaranthaceae	Kan siavappu, Kan erichal, kansoodu, kankoocham. <sup>28</sup>
4.	Erukku	Calotropis gignentia	Apocynaceae	Sanni vaatham, Sanni <sup>18, 35</sup>
5.	Uthamani	Pergulariadaemia	Apocynaceae	Sagala viriyan kad <sup>40</sup>
6.	Maan sevikalli	Cacaliaklerini	Asteraceae	Kendaivaatham, Sagala viriyan kad <sup>29</sup>
7.	Thel kodukku	Heliotropium indicum	Boraginaceae	Anda vaayu, Kai kaal mudakku, udal kaduppu, kuthal <sup>21, 39</sup>
8.	Aavarai	Cassia auriculata	Caesalpiniaceae	Aanantha vaatham, Virai vaatham, Mulangaalvaathapidippu, Neela kaasam, Pithakaasam, Mantha kaasam, Padalam, Pillam, Mayir kuthal, Puzhuvettu, Malai kaneerodithal, Kuntham, Nethiravaari <sup>18, 23, 38, 39, 49</sup>
9.	Kazharchi	Caesalpinia bonduc	Caesalpiniaceae	Andavaatham, Kai kaal mudakku, udal kaduppu, kuthal, vidam <sup>21, 28</sup>
10.	Sarakondrai	Cassia fistula	Caesalpiniaceae	Kannoi <sup>28</sup>
11.	Veezhi	Cadava trifoliata	Capparaceae	Mulangaalvaathapidippu, Sagala viriyan kad <sup>23, 39, 40</sup> 49
12.	Thaivelai	Cleome gynandra	Capparaceae	Anda vayu <sup>39</sup>
13.	Viluthi	Cadabafruticosa	Capparaceae	Sanni <sup>16</sup>
14.	Maavilingam	Crataeva magna	Capparaceae	Sanni, vidam, Moolam <sup>16, 39, 40</sup>
15.	Kurattai	Trichosanthes tricuspidate	Cucurbitaceae	Arputha vayu <sup>10</sup>
16.	Peikumatti	Citrullouscolocynthis	Cucurbitaceae	Vidam <sup>40</sup>
17.	Peipeerku	Luffa amara	Cucurbitaceae	Vidam <sup>40</sup>
18.	Aamanakku	Ricinus communis	Euphorbiaceae	Santhuvaatham, Sanni <sup>18</sup>
19.	Chinni	Acalypha fruticose	Euphorbiaceae	Sagala viriyan kad <sup>40</sup>
20.	Pungu	Pongamia glabra	Fabaceae	Sanni <sup>40</sup>
21.	Puli	Tamarindus indica	Fabaceae	Neela kaasam, Pithakaasam, Mantha kaasam, Padalam, Pillam, Mayir kuthal, Puzhuvettu, Malai kaneerodithal, Kuntham, Nethiravaari, Kan vali <sup>30, 39, 41</sup>
22.	Karuvil	Acacia arabica	Fabaceae	Vizhi veekam, erithimavupadalam, sivappukaruppu, neerodithal <sup>39</sup>
23.	Vaagai	Albizia lebeck	Fabaceae	Sagala viriyan kad <sup>40</sup>
24.	Kozhiyavarai	Canavalia ensiformis	Fabaceae	Sagala viriyan kad <sup>39</sup>
25.	Agathi	Sesbania grandifolia	Fabaceae	Sagala viriyan kad <sup>40</sup>
26.	Vellaikakkanam	Clitoriaternatea	Fabaceae	Sagala viriyan kad <sup>40</sup>
27.	Avuri	Indigo fertinctour	Fabaceae	Vidam <sup>40</sup>
28.	Notchi	Vitex negundo	Lamiaceae	Vaatham, Kuthivaatham <sup>5</sup> , Santhuvaatham, Sanni <sup>16, 18</sup>





## Lavanya et al.,

				<i>Sagala viriyankadi</i> <sup>40</sup> , <i>Veekam</i> , <i>Varmakaayam</i> , <i>udambu vali</i> , <i>moolam</i> <sup>20, 29, 38, 39, 41, 49</sup>
29.	<i>Thulasi</i>	<i>Ocimum sanctum</i>	Lamiaceae	<i>Neela kaasam</i> , <i>Pithakaasam</i> , <i>Mantha kaasam</i> , <i>Padalam</i> , <i>Pillam</i> , <i>Mayir kuthal</i> , <i>Puzhuoettu</i> , <i>Malai kaneervadithal</i> , <i>Kuntham</i> , <i>Nethiravaari</i> , <i>Sagala viriyankadi</i> , <i>vidam</i> <sup>31</sup>
30.	<i>Karanthai</i>	<i>Osimumbasilicum</i>	Lamiaceae	<i>Sagala viriyan kadi</i> <sup>40</sup>
31.	<i>Thumbai</i>	<i>Leucas aspera</i>	Lamiaceae	<i>Sagala viriyan kadi</i> , <i>vidam</i> <sup>40</sup>
32.	<i>Etti</i>	<i>Strychnosnux-vomica</i>	Loganiaceae	<i>Ammaikuru</i> <sup>31</sup>
33.	<i>Thuthi</i>	<i>Abutilon indicum</i>	Malvaceae	<i>Kannoi</i> <sup>49</sup>
34.	<i>Chitramutti</i>	<i>Pavoniazeylanica</i>	Malvaceae	<i>Sagala viriyan kadi</i> <sup>40</sup>
35.	<i>Kaaya</i>	<i>Memocylonedule</i>	Melastomataceae	<i>Vizhi veekam</i> , <i>Eriovu</i> , <i>Thinavu</i> , <i>Padalam</i> , <i>Sivappu</i> , <i>Kaduppu</i> , <i>Neer vadithal</i> <sup>30</sup>
36.	<i>Vembu</i>	<i>Azhadiracta indica</i>	Meliaceae	<i>Thimirovaatham</i> , <i>mulangaalvaatham</i> , <i>kuthuvaatham</i> , <i>mootuvaatham</i> , <i>Sanni</i> , <i>vidam</i> , <i>Soolai in ammainoi</i> , <i>udambu vali</i> <sup>1, 16, 40</sup>
37.	<i>Seenthil</i>	<i>Tinospora cordifolia</i>	Menispermaceae	<i>Sanni</i> <sup>20</sup>
38.	<i>Paagal</i>	<i>Artocarpus integrifolia</i>	Moraceae	<i>Vidam</i> <sup>32, 40</sup>
39.	<i>Aalamaram</i>	<i>Ficus benghalensis</i>	Moraceae	<i>Kuthirai vali</i> <sup>31</sup>
40.	<i>Murungai</i>	<i>Moringa oleifera</i>	Moringaceae	<i>Sagala viriyankadi</i> , <i>vidam</i> <sup>40</sup>
41.	<i>Thara</i>	<i>Fumaria parviflora</i>	Papaveraceae	<i>Murivu</i> <sup>31</sup>
42.	<i>Kozhunji</i>	<i>Glycosmis arborea</i>	Rutaceae	<i>Sagala viriyankadi</i> , <i>vidam</i> <sup>32, 40</sup>
43.	<i>Mudakatran</i>	<i>Cardiospermum halicacabum</i>	Sapindaceae	<i>Andavaatham</i> , <i>Thimirovaatham</i> , <i>mulangaalvaatham</i> , <i>kuthuvaatham</i> , <i>mootuvaatham</i> , <i>Anda soolai</i> <sup>33, 23</sup> , <i>Sanni</i> <sup>1, 16, 28</sup> , <i>Sagala viriyan kadi</i> , <i>vidam</i> <sup>40, 39</sup>
44.	<i>Iluppai</i>	<i>Madhuca longifolia</i>	Sapotaceae	<i>Sagala viriyan kadi</i> <sup>40</sup>
45.	<i>Umathai</i>	<i>Datura metel</i>	Solanaceae	<i>Santhuvaatham</i> , <i>Anda vayu</i> <sup>18</sup> , <i>Sanni</i> <sup>39</sup>
46.	<i>Pirandai</i>	<i>Cissus quadrangularis</i>	Vitaceae	<i>Sagala viriyan kadi</i> <sup>40</sup>

Table.4.Flowers used for Otradam (Fomentation Therapy)

S. No	Plant name	Botanical name	Family name	Indication
1.	<i>Erukku</i>	<i>Calotropis gigantea</i>	Apocynaceae	<i>Sanni vaatham</i> , <i>mugasanni</i> , <i>sanni</i> <sup>27, 39</sup>
2.	<i>Sirukurinjan</i>	<i>Gymnemasylvestre</i>	Asclepiadaceae	<i>Kurangu kadi</i> <sup>32</sup>
3.	<i>Sirunaga poo</i>	<i>Mesua nagassarium</i>	Clusiaceae	<i>Pungal</i> <sup>6, 27</sup>
4.	<i>Aavarai</i>	<i>Cassia auriculata</i>	Fabaceae	<i>Anda vayu</i> <sup>27</sup>
5.	<i>Murungai</i>	<i>Moringa oleifera</i>	Moringaceae	<i>Sanni</i> <sup>20</sup>

Table.5.Barks used for Otradam (Fomentation Therapy)

S. No	Plant name	Botanical name	Family name	Indication
1.	<i>Etti</i>	<i>Strychnos nux-vomica</i>	Apocynaceae	<i>Siddha vipramasanni</i> , <i>muga sanni</i> <sup>27, 35</sup>
2.	<i>Kodikkalli</i>	<i>SarcosemmaBrevistigma</i>	Apocynaceae	<i>Muga sanni</i> <sup>27, 35</sup>
3.	<i>Maavilingam</i>	<i>Crataeva magna</i>	Capparaceae	<i>Siddha vipramasanni</i> , <i>mugasanni</i> , <i>sirasilneertramandai vali</i> <sup>20, 35, 47</sup>





Lavanya et al.,

4.	Maruthu	<i>Terminalia arjuna</i>	Combretaceae	Vizhi veekam, erivu, thinavu, padalam, sivappu, kaduppu, neer vaditha <sup>30, 39</sup>
5.	Kundrimani	<i>Abrus precatorius</i>	Fabaceae	Nayana viyathi, Pungal <sup>27</sup>
6.	Venbu	<i>Azhadiracta indica</i>	Meliaceae	Siddha vipramasanni, Pungal <sup>27, 45</sup>
7.	Arasamarm	<i>Ficus religiosa</i>	Moraceae	Kai kaal vedippu and vali <sup>39</sup>
8.	Murungai	<i>Moringa oleifera</i>	Moringaceae	Kuthirai vali <sup>20</sup>
9.	Lavangam	<i>Syzygium aromaticum</i>	Myrtaceae	Moolam <sup>17</sup>
10.	Vembadam	<i>Ventiligomadraspatana</i>	Rhamnaceae	Nayana viyaathi, Pungal <sup>6</sup>

Table.6 Explanation for the Indications Mentioned

Name of the Disease	Explantion of the disease <sup>50</sup>
Anandha vayu	kind of diseases affecting the scrotum and the spermatic cord
Anda soolai	A neuralgic pain of severe dearting and throbbing character experience in the testicles
Andavatham/ andavayyu	Hydrocele
Arayappu	An ordinary bubo in the groins/ an inflammation and swelling of a lymphatic gland, genera in the groin
Arputha vaatham/vaayu	A kind of facial paralysis
Kaasam (Neela kaasam, Mantha kaasam, Pithakaasam)	Cataract and its types
Kai kaal mudakku	A kind of rheumatism which affects the joints of hand and leg
Kan erichal/Vizhi erivu	Burning sensation of the eyes
Kan koocham	Incapacity of the eyes to receive light from external objects owing to extreme sensitiveness
Kan noi/Nethiraviyathi	Eye disease
Kan soodu/ Kan azhal	Inflammation of the eye
Kan vali	Eye Pain
Kansivappu	Inflammation of the eye or eye lid
Kuntham	Protrusion in the cornea of the eye
Kurangu kadi	Monkey bite
Kuthikaalvaatham/ Kuthi vaatham	A disease of the heel rendering one unable to rest on the heel owing to excessive neuralgic pain
Kuthiraivalippu	Apoplectic fits due to vitiated vaatha humour in the system
Maalai kaneervadithal	Watery eyes in evening time
Mantha kaasam	Cataract causing dullness of vision
Mayir kuthal	Trichiasis
Moolam	Haemorrhoids
Muga vaathasanni	Tetanus combined with lock jaw and sudden paralysis of the facial nerve
Mugavatham	Facial Paralysis
Mulangalvaathapidippu/ Kendaivaatham	Spasm of calf muscle
Murivu	Fracture
Nethiravaari	Tears
Oozhinoi	Oozhinoi
Paambuvidam	Snake bite
Padalam	A growth starts in the clear part of the eye
Pillam	A disease of the eye lid





## Lavanya et al.,

<i>Pithakaasam</i>	Cataract attended with bilious humour of the eye
<i>Pungal</i>	Ulcer
<i>Puzhuvettu</i>	Alopecia
<i>Sagala viriyan kadi</i>	Viper bite
<i>Sanni</i>	Privation of sense and voluntary motion resulting from the affection of the nerves through the derangement of the three humours in the system.
<i>Sanni vaatham</i>	Rheumatism attended with chillness as a result of excess of heat due to the cerebral affections manifested by the derangement of the three humours in the system.
<i>Santhuvaatham</i>	Arthritis
<i>Siddha vipramasanni</i>	A type of sanninoid
<i>Sirasilneertramandai vali</i>	Sinusitis
<i>Suram</i>	Fever
<i>Thimirvaatham</i>	A kind of palsy or paralysis followed by privation of feeling or motion due to anemic and anesthetic condition of the body.
<i>Vaatham</i>	Disease due to vitiated vaatham
<i>Veekam</i>	Swelling
<i>Viraivaatham</i>	Scrotal swelling
<i>Vizhi veekam</i>	Swelling of the eyelid







## Ethnomedicinal Studies on Nishi Inhabitants of Kurung Kumey of Arunachal Pradesh

Jonardan Hazarika<sup>1\*</sup>, Parinita Devi Nath<sup>1</sup> and Tinamoni Hazarika<sup>2</sup>

<sup>1</sup>Assistant Professor, Department of Botany, Tingkhong College, (Affiliated to Dibrugarh University) Assam, India.

<sup>2</sup>Assistant Professor, Department of Botany, Duliajan College, (Affiliated to Dibrugarh University) Assam, India.

Received: 30 Jan 2024

Revised: 09 Feb 2024

Accepted: 26 Apr 2024

### \*Address for Correspondence

**Jonardan Hazarika**

Assistant Professor,

Department of Botany,

Tingkhong College, (Affiliated to Dibrugarh University)

Assam, India.

Email: jonardanhazarika@gmail.com



This is an Open Access Journal / article distributed under the terms of the **Creative Commons Attribution License** (CC BY-NC-ND 3.0) which permits unrestricted use, distribution, and reproduction in any medium, provided the original work is properly cited. All rights reserved.

### ABSTRACT

This study focuses on the traditional ethnomedicinal knowledge of medicinal plants of the Nishi tribe inhabiting in the KurungKumey which is located in the upper region of Arunachal Pradesh. The area comprises of many other tribes although Nishi tribal population is in majority. The communities are the original inhabitants of the study area and have come from various parts of Asia since time immemorial. The less industrialization and low interaction with other parts of the state and boundary has helped in the conservation of the species both in wild and farm and also retaining of the knowledge in its purest form. The raw materials needed to practise these medicines are collected from nearby reserve forest or/and individual cultivation. The present survey reported 30 plants belonging to 20 families used by the studied tribe which help to cure 32 diseases either individually or in combination including menstrual problems and leprosy. The tabular form of the reported species is presented according to the disease cured and composition required to cure the disease. The study also tried to make a comparative study of the plants by different families, composition and parts used.

**Keywords:** Nishi, KurungKumey, Arunachal Pradesh, Ethnomedicine, Disease





Jonardan Hazarika et al.,

## INTRODUCTION

Research on medicinal plants among the tribal communities of North-East India have increased in the recent time mainly in the untouched regions of hilly terrain areas of the states like that of Arunachal Pradesh. Drugs obtained from plants have been use from common cold to cancer [1]. The World Health Organization(WHO) is also interested in recording the use of therapeutic plants from various tribes across the globe [2]. Medicine based on plants has better cultural acceptability, affordability and with minimum side effects[3-4]. In India, 45,000 plant species are said to have therapeutic properties[5]. India has over 104 million tribal populations belonging to 573 tribal communities representing 8.6% of total Indian population (15<sup>th</sup> Indian Census, 2011). These tribal communities mostly depend on traditional knowledge for their local health care needs[6].The state of Arunachal Pradesh is one of the richest biotic regions of Indian subcontinent. It is bounded on the south by Assam and Nagaland, on the north and north east by China, on the west by Bhutan, and on the east by Myanmar. The area is predominantly a mountainous tract situated in the Eastern Himalayan foothills and is part of the IUCN-designated Himalaya Biodiversity Hotspot. It is a tribal state in its entirety, consisting of 19 districts inhabited by 26 major tribes and 110 sub-tribes with unique culture and lifestyle, with a rich Indigenous Knowledge System (IKS) that has occupied different geographical places since time immemorial. The Nishi Tribe is a significant tribe in Arunachal Pradesh. 'NYI' means "a human," and 'shi' means "a being," therefore both words refer to humans. With a population of roughly 3 lakhs, they are Arunachal Pradesh's most numerous tribes. Eight districts in Arunachal Pradesh—Kradaadi, Kurungkumey, East Kameng, Papumpare, PakkeKessang, and Kamie—have Nishi populations. The majority of Nishi people live in the Kungkumey, Kradaadi, and East Kameng, and they primarily speak Nishi and Hindi (Nishi Language belongs to Sino-Tibetan origin). Economically Nishi are agriculturist and Jhum cultivation is a common practice. Rice, Maize, Millet, Cucumber etc are the principal crop grown. According to 2011 census, most of the population follows their ancient Indigenous religion called 'Dongi-poloism' (Worship of Sun and Moon) altogether in the recent decade other religion like Christianity (31%, 2011 census), Hinduism (29%, 2011 census) are also followed. There is an urgent need to chronicle and conserve traditional knowledge on the various applications of medicinal plants in Arunachal Pradesh, a rich region of Northeast India. Thus, the main goal of the current ethnobotanical study was to compile a database of ethnomedicinal plants utilized by the Nishi Tribe of Arunachal Pradesh to cure various ailments. This essay examines the ethnobotanical study of potential therapeutic plants used by the Nishi tribe in the KurungKumay district of Arunachal Pradesh, India.

## METHODOLOGY

Current ethnobotanical study was carried out in the Kurungkumey district of Arunachal Pradesh during the month of October, 2022. Geographically the area is situated in the eastern Himalayas, and hence experiences more rainfall and low temperature throughout the year and good vegetation coverage than the other part of the region. This study documented the traditional knowledge on medicinal plants of the Nishi tribe living in the study area. Information was gathered about the various plant species that are employed, their parts, composition, and methods of administration. The various criteria employed in methodology include the interview with the ethnic people from the area, traditional healers, tribal elders from the area etc. utilizing formal discussions, questionnaires, and timetables, ethnomedical data were gathered utilizing Jain's [7] methodology through casual encounters with the informants. A total of 98 people from various ages, profession and gender were interviewed which includes 50 households from four villages under Nyobia circle. These villages are Byasi, Upper Gida, Langro and Langarh. These sources had knowledge of the therapeutic use of the plants and were either self-employed traditional healers or came from families that practiced it. The essential plants used by them are mainly collected mostly from the forest while some of them have been cultivated domestically. Not all the enumerated plant species could be identified while most of them were identified with the help of relevant and standard literature and valuable reference from Botanical Survey of India (BSI), Itanagar. The identified are given here in their local names and the various formulations used for curing the targeted disease.





Jonardan Hazarika et al.,

## RESULTS

During this study, 30 identified different species of plants that belong to 20 families were found to use as traditional health care services by the Nishi Tibal community of KurungKumay district. Out of these all are Angiosperm. Herbs are the most dominant which constitute 11 species followed by 10 shrubs and 9 trees represented in **Graph 1**. **Table 1** enlisted the diseases cured by the various species of plants commonly utilized by the local tribal communities of the research area. **Graph 2** shows that the Poaceae are the most dominant families with 5 species followed by Solanaceae, Asteraceae and Musaceae with other 16 families with 1 species each. This study arranges the collected and identified 30 plants according to disease, parts used and number of species belonging to different families. It further refers that a total number of 32 methods both in composition and singly are being used for the cure of 23 diseases. Leaf is the highest used parts as found in the study (**Graph 3**). With regard to diseases, stomach problem, gastric and tooth ache are the ones against which has the highest number of therapeutic plants recommended, then followed by menstruation and leprosy.

## DISCUSSION

Nishi, the tribal community; studied harness a wide knowledge of plants and their medicinal use and preparation. Most of them are taken internally and has specific preparation technique. The commonly used methods for the preparation of the medicine are by grinding and boiling with water as a medium in the area of research. The other preparation techniques involve pounding and powdering fresh plant materials. Due to the presence of abundant fresh plant material in the area of study, application of fresh plant parts was preferred over dry stored material and prepared mostly in composition. The aged people were the most important contributors of the survey. Care was taken to have an equal consideration among all tribes and the women folks were given a significant role in the study because they are more knowledgeable about the effectiveness of indigenous plants in treating different disorders. Religious words and practice, belief while preparing the medicines are also present within the community. Most of them are in the endemic and has been facing or may face extinction in near future so studies and documentation of this traditional knowledge will help in the preservation and cultivation of those plants used in the medicine. Thus, immediate action is required to document the traditional knowledge before it is lost. The knowledge of known medicinal qualities of the non-edible and non-agricultural plants has helped them to survive among the residential areas of these tribes. The cultivation of medicinal plants bears both ecological and social importance.[8]

## CONCLUSION

The tribal communities of Arunachal Pradesh have been practising the use of traditional herbal medicine since before their migration to the present study area and this habit has been inherited from one generation to another by heredity. The traditional knowledge regarding medicine proves to be the most important assets of the tribal communities of the study area. The present situation has led to rapid decrease of this knowledge due to lack of interest and the continuous destruction of the habitat. The documentation of plants and their uses will help for raising awareness for conservation as well as economic development of the study area. More scientific investigation into the plant-based traditional knowledge of indigenous peoples may open up new opportunities for pharmacological research as well as the creation of environmentally friendly products that improve quality of life.

## REFERENCE

1. D Devendra Kumar, M Anbazhagan, V Gomathi, R Rajendran, Traditional Phytotherapy of diabetes used by the people of Perambur district, Tamil Nadu, South India, *Recent Research in Science and Technology*, 1(6) (2009) 287-290.





## Jonardan Hazarika et al.,

2. Dev S, Ethno-therapeutics and modern drug development: the potential of Ayurveda. *Current Science*; 73(11) (1997) 909–928.
3. Kamraj VP, Herbal medicine, *Current Science*, 78(1) (2000) 35-39.
4. Anonymous, *Traditional Medicines Strategy*, 2002-2005, (World Health Organization, Geneva), 2002.
5. Lewington A, Medicinal plants and plant extracts: A review of their importation into Europe. A traffic network report. *Traffic International*, Cambridge, 1993.
6. Dutta B. K, Dutta P. K; Potential of ethnobotanical studies in North East India: An overview. *Indian Journal of Traditional Knowledge*, 4 (2005) 7-14.
7. Jain S. K., The role of botanist in folklore research, *Folklore*, 5 (4) (1964) 145-150.
8. Deb S, Arunachalam A, Das AK, Indigenous knowledge of Nishi tribes on traditional agroforestry systems, *Indian Journal of Traditional Knowledge*, 8(1) (2009) 41-46.

**Table 1: The diseases cured by the plant species commonly used by the local Nishi tribal communities of the study area**

Sl no.	Botanical name	Local name	Family	Habit	Preparation method and uses
1	<i>Solanum aculeatissimum</i> Jacq.	Taye lobo	Solanaceae	shrub	Ripen fruit is kept in fireplace till it get properly warm and then it is kept in between the infected tooth. It is done for 2 days. And in a day two doses are taken for fast relief of toothache.
2	<i>Ageratum conyzoides</i> L.	Pashu payu	Asteraceae	herb	Leaves extract is used in cuts and wounds, it helps in blood clotting. It is also use to cure eye problems.
3	<i>Acmella oleracea</i> R.K.Jansen	Marsang au	Asteraceae	herb	The inflorescence of the plants is chewed to treat toothache and also to clear stomach problems.
4	<i>Solanum nigrum</i> L.	Hore au	Solanaceae	herb	Leaf portion of the plant is half boiled with little amount of water and the leaf as well as soup is prepared and it is taken to cure gastric problems.
5	<i>Clerodendron colebrookianum</i> Lindl.	Puto au	Verbenaceae	shrub	Leaf is boiled and eaten along with the soup to cure high blood pressure.
6	<i>Iringiagabonensis</i> Baill.	Aam sangne	Anacardiaceae	tree	Plant bark is crushed properly with small amount of water and it is mixed properly with hand and applied in the feet area of the body to cure jaundice.
7	<i>Kyllingamonocephala</i> Rottb.	Midar	Gramineae	herb	1. Whole plant is crushed properly and mixed with required amount of mustard





## Jonardan Hazarika et al.,

					oil and applied in the feet area of the body. It should be done once in a day to cure jaundice. 2. In another method a bowl containing mustard oil is kept above the head region and a long grass is rotate inside the bowl in the mustard oil. These activities should be carried out for 1 hour in a day. And the treatment should continue for three days.
8	<i>Psidium guajava</i> L.	Mudhri	Myrtaceae	tree	Leaf is crushed and extract is used in curing dysentery, loose motion and other stomach problem.
9	<i>Musa acuminata</i> Colla.	Kupa	Musaceae	herb	Banana + worm+ guava leaf is ground together with one glass of water. To cure fever. In a day 2 doses are taken and it will take 3 to 4 days to cure fever.
10	<i>Carica papaya</i> L.	Papita	Caricaceae	tree	Papaya fruit is ground and mixed with rice soup. It will help in curing lactation problems.
11	<i>Bambusabalcooa</i> Roxb.	Ehe	Poaceae	tree	Edible part of bamboo reduces insomnia.
12	<i>Xanthoxylumarmatum</i> DC.	Sana	Rutaceae	shrub	Seed is eaten to treat heart problems, food allergy. Seed is eaten in raw.
13	<i>Curcuma caesia</i> Roxb.	Yakia taki	Zingiberaceae	shrub	Rhizome is grinded and mixed with one glass of water. This is very helpful to cure gastric. One dose a day
14	<i>Prunus persica</i> Batscn.	Makam	Rosaceae	tree	Small branch is chewed for teeth whitening.
15	<i>Piper longum</i> L.	Sutumrariy	Piperaceae	shrub	Used against yellowing of teeth
16	<i>Musa balbisiana</i> Colla.	Kuduk kupa	Musaceae	tree	Banana is helpful in controlling loose motion but if taken in large amount it can cause severe constipation.
17	<i>Eleusine coracana</i> Gearth.	Tami	Poaceae	herbs	First bear prepared from it is helpful in maintaining menstruation cycle and also relieving menstruation pain.





## Jonardan Hazarika et al.,

18	<i>Bambusa vulgaris</i> Schrad ex J.C.Wendl.	Ekuingng	Poaceae	tree	Applied on the place of bee's bite
19	<i>Oryza sativa</i> L.	Ampe	Poaceae	shrub	Rice cover is burned and the smoke is inhale through nose and mouth. To relieve sore throat and changed voice.
20	<i>Musa acuminata</i> Colla.	Kupapagya	Musaceae	tree	Partially decomposed banana leaf is wrapped around the swollen portion of the body. It also cures leg and body infection.
21	<i>Drymaria cordifolia</i> Willd Ex Schult.	Kichik kinyik	Caryophyllaceae	herb	Leaf is collected and wrapped in a banana leaf and kept in the fire place for few minutes. Finally, it is applied in the whole body to cure leprosy. It takes 2 to 3 months for curing person showing less infection but it took 1 year to cure the Person who has severe cases of leprosy.
22	<i>Paris polyphylla</i> Sm.	Nyoruinyi	Melanthiaceae	shrub	The rhizome is made into a paste and directly applied in the place of snake bite. And it works within 30 minutes.
23	<i>Bambusa tulda</i> Roxb.	Hitey	Poaceae	tree	Bark is peeled off and applied in the wound. For healing and early recovery
24	<i>Lobelia nummularia</i> Lam.	Yabindumru	Campanulaceae	herb	Whole plant is used to cure leprosy
25	<i>Centella asiatica</i> (L.) Urban	Mani muni	Apiaceae	herb	Leaf is steamed and along with soup it is taken to treat gastric
26	<i>Pouzolzia hirta</i> Gaudich.	Husuakhuyuk	Urticaceae	herb	Leaf is boiled and eaten to cure liver infection and other liver problems.
27	<i>Cucurbita maxima</i> Duchesne.	Pene au	Cucurbitaceae	shrub	Leaf is boiled and eaten to cure partial paralysis. It is also used to cure eyesight problems.
28	<i>Acmella paniculata</i> R.K.Jansen	Marsang au.	Asteraceae	shrub	Toothache
29	<i>Solanum viarum</i> Duncl.	Kata pul	Solanaceae	shrub	Fruit is warmed in the fireplace and put on the infected tooth, helps in curing tooth ache
30	<i>Houttunzia cordata</i> Thunb.	Hungya	Saururaceae	herb	Raw leaf is eaten to cure gastric.





Jonardan Hazarika et al.,

<p><b>Fig 1: Location of the Study Area</b></p>	<p><b>Fig 2: <i>Lobelia nummularia</i> Lam</b></p>																																										
<p><b>Fig 3: <i>Paris polyphylla</i> Sm</b></p>	<p><b>Fig 4: <i>Piper longum</i> L.</b></p>																																										
<p style="text-align: center;">no. of species</p>	<p style="text-align: center;">NO. OF SPECIES</p> <table border="1"> <caption>Family wise representation of reported plant species</caption> <thead> <tr> <th>Family</th> <th>No. of Species</th> </tr> </thead> <tbody> <tr><td>Solomonaceae</td><td>3</td></tr> <tr><td>Asteraceae</td><td>3</td></tr> <tr><td>Verbenaceae</td><td>1</td></tr> <tr><td>Amaranthaceae</td><td>1</td></tr> <tr><td>Gramineae</td><td>1</td></tr> <tr><td>Myrsinaceae</td><td>3</td></tr> <tr><td>Mitacoaceae</td><td>1</td></tr> <tr><td>Carlinaceae</td><td>1</td></tr> <tr><td>Rosaceae</td><td>5</td></tr> <tr><td>Rubiaceae</td><td>1</td></tr> <tr><td>Zingiberaceae</td><td>1</td></tr> <tr><td>Boraginaceae</td><td>1</td></tr> <tr><td>Piperaceae</td><td>1</td></tr> <tr><td>Caryophyllaceae</td><td>1</td></tr> <tr><td>Melastomaceae</td><td>1</td></tr> <tr><td>Campanulaceae</td><td>1</td></tr> <tr><td>Apiaceae</td><td>1</td></tr> <tr><td>Urticaceae</td><td>1</td></tr> <tr><td>Cucurbitaceae</td><td>1</td></tr> <tr><td>Saururaceae</td><td>1</td></tr> </tbody> </table>	Family	No. of Species	Solomonaceae	3	Asteraceae	3	Verbenaceae	1	Amaranthaceae	1	Gramineae	1	Myrsinaceae	3	Mitacoaceae	1	Carlinaceae	1	Rosaceae	5	Rubiaceae	1	Zingiberaceae	1	Boraginaceae	1	Piperaceae	1	Caryophyllaceae	1	Melastomaceae	1	Campanulaceae	1	Apiaceae	1	Urticaceae	1	Cucurbitaceae	1	Saururaceae	1
Family	No. of Species																																										
Solomonaceae	3																																										
Asteraceae	3																																										
Verbenaceae	1																																										
Amaranthaceae	1																																										
Gramineae	1																																										
Myrsinaceae	3																																										
Mitacoaceae	1																																										
Carlinaceae	1																																										
Rosaceae	5																																										
Rubiaceae	1																																										
Zingiberaceae	1																																										
Boraginaceae	1																																										
Piperaceae	1																																										
Caryophyllaceae	1																																										
Melastomaceae	1																																										
Campanulaceae	1																																										
Apiaceae	1																																										
Urticaceae	1																																										
Cucurbitaceae	1																																										
Saururaceae	1																																										
<p><b>Graph 1: Habit wise presentation of reported species</b></p>	<p><b>Graph 2: Family wise representation of reported plant species</b></p>																																										
<p style="text-align: center;">Quantity</p>																																											
<p style="text-align: center;"><b>Graph 3: Parts used for preparation of medicine</b></p>																																											





## Antifungal Activity of *Cassia auriculata* L. and its Spectral Analysis by HPLC and FT-IR

V. Sankara Vel<sup>1</sup>, S. Sreeram<sup>2</sup>, U. Vino<sup>3</sup> and A. Arunprasath<sup>1\*</sup>

<sup>1</sup>Assistant Professor, Department of Botany, PSG College of Arts and Science, (Affiliated to Bharathiar University) Coimbatore, Tamil Nadu, India.

<sup>2</sup>Ph. D Research Scholar, Department of Botany, PSG College of Arts and Science, (Affiliated to Bharathiar University) Coimbatore, Tamil Nadu, India.

<sup>3</sup>Ph. D Research Scholar, Department of Biochemistry, PSG College of Arts and Science, (Affiliated to Bharathiar University) Coimbatore, Tamil Nadu, India.

Received: 22 Jan 2024

Revised: 09 Feb 2024

Accepted: 03 May 2024

### \*Address for Correspondence

#### A. Arunprasath

Assistant Professor,  
Department of Botany,  
PSG College of Arts and Science,  
(Affiliated to Bharathiar University)  
Coimbatore, Tamil Nadu, India.  
Email: arunprasath@psgcas.ac.in



This is an Open Access Journal / article distributed under the terms of the **Creative Commons Attribution License** (CC BY-NC-ND 3.0) which permits unrestricted use, distribution, and reproduction in any medium, provided the original work is properly cited. All rights reserved.

### ABSTRACT

This study aimed to investigate the antifungal activity of unrefined concentrates from *Cassia auriculata* (leaves and stems) and analyze their functional groups using Fourier-transform infrared spectroscopy (FTIR) and High-Performance Layer Chromatography (HPLC). The research also sought to determine the Minimal Inhibition Concentration (MIC) of the extracts against two fungal isolates, *Aspergillus flavus* and *Aspergillus niger*. Dried and powdered leaves and stems of *Cassia auriculata* were utilized for extraction, employing methanol, hexane, and chloroform as solvents. Antifungal activity was assessed using standard procedures, with zones of inhibition measured at various concentrations. FTIR analysis was conducted to identify functional groups in the leaf and stem extracts. HPLC was employed to profile the methanol extracts and identify constituents. The antifungal activity of methanol, chloroform, and hexane extracts showed varying zones of inhibition against *Aspergillus flavus* and *Aspergillus niger*. FTIR analysis revealed the presence of functional groups in both leaf and stem extracts, including firm expansive, weak broad, and medium pinnacle groups. HPLC profiling identified myricetin as a prominent component, with the highest peak observed in the methanol extract. In leaves, myricetin was found at peak 4, while in stems, it appeared at peak 6. *Cassia auriculata* extracts demonstrated significant antifungal activity against *Aspergillus flavus* and *Aspergillus niger*. FTIR analysis confirmed the presence of distinctive functional groups, while HPLC profiling identified myricetin as a key constituent. These findings

73787







Sankara Vel et al.,

underscore the potential of *C.auriculata* as a source of antifungal agents, warranting further exploration for pharmaceutical applications.

**Keywords:** Antifungal activity, *Cassia*, FTIR, HPLC, myricetin

## INTRODUCTION

Methanol extract, chloroform extract, and hexane extract were used to test antifungal activity, and the zones of inhibition were shown at varying concentrations. The two fungal isolates, *Aspergillus flavus* Link and *Aspergillus niger* Tiegh. were examined in MIC-Minimal Inhibition Concentration of the extracts. The existence of utilitarian groupings was shown by FTIR analysis of leaf and stem separation, which revealed firm expansive, weak broad, and medium pinnacle. The presence of myricetin may be seen in the HPLC profile of the methanol concentrate of *Cassia auriculata*'s most elevated pinnacle zone in leaf and stem extricates [1]. These applications assist secondary metabolites, which act as defense experts against invading microorganisms. Plant concentrations from a variety of higher plants have been tested in the lab and found to have antibacterial, antifungal, and insecticidal effects [2&3]. Tanner's Cassia, or *Cassia auriculata* L., is an important medicinal shrub used in traditional medicine. In the Ayurvedic and Siddha systems of medicine, it has a very high status. It's useful as a tanning resource as well as a green fertilizer crop. Antipyretic, hepatoprotective, antidiabetic, antiperoxidative, antihyperglycemic, and microbicidal properties have been reported for the plant [4&5]. After standardization, the extract obtained can be used as a medicinal agent in tinctures or liquid concentrates or further processed to be combined in any dosage form, such as tablets and capsules. These products contain a complex blend of several therapeutic plant metabolites, such as alkaloids, glycosides, terpenoids, flavonoids, and lignans [6]. Aspergillosis, various distinctive ailment states in people brought about by parasites of the family *Aspergillus*, particularly *A. flavus* and *A. niger*, produce an assortment of impacts on people, going from no ailment unfavorably susceptible responses to mellow pneumonia to overpowering summed up contamination. Serious cases, including an aspergilloma (contagious mass) and seeping in the lungs, may require medical procedure or embolization. As a rule, the expulsion of the patient from the ecological source brings about clinical improvement [7]. Over 25% of the world's oats are tainted with known mycotoxins and more than 300 fungal metabolites are reported to be poisonous to man and creatures [8].

The principal harmful impacts are cancer-causing nature, genotoxicity, teratogenicity, nephrotoxicity, hepatotoxicity, regenerative issues, and immune suppression [9&10]. The microorganisms have recently created resistance to antimicrobial operators, essentially subsequently to their wide-spreading use; it has focused on a ton of the pursuit of new compounds with antimicrobial properties from different sources. In this hunt, the improvement of antifungal operators has unquestionably fallen behind the advancement of antibacterial agents [11]. FTIR has been demonstrated to be an exact, quick and straightforward technique for phytochemical screening. It gives more data through the unique mark locales of herbal medicines, delivering the procedure immediately and straightforwardly [12&13]. Already, FTIR has been utilized in distinguishing proof and population separation examines. Tests from the various populations can be segregated dependent on the useful gathering ingestion [14&15]. In most strategies, crude plant separates are fractionated and purified by strong solid-phase extraction, liquid-liquid extraction, or gas or liquid chromatography to expand hormone concentration and the plant hormones are identified by radioimmunoassay, enzyme-linked immunosorbent assays (ELISAs), flame ionization, UV, fluorescence, or electrochemical identification [16&17]. The affectability and explicitness of high-performance liquid chromatography (HPLC) with electrochemical identification can restrict its application to estimate an assortment of endogenous plant hormones at physiological levels in plant samples [18]. Fingerprinting technique has been generally acknowledged as a helpful technique for assessing and quality control of herbal materials and their completed items. A few methods, for example, thin-layer chromatography (TLC), gas chromatography (GC), capillary electrophoresis (CE), infrared spectroscopy (IR), high-performance liquid chromatography (HPLC), ultra-violet spectroscopy (UV), mass spectrometry (MS), and nuclear magnetic resonance (NMR) can be applied for fingerprinting. This investigation



**Sankara Vel et al.,**

accentuation on the impact of unrefined concentrate of *C. auriculata* (leaf and stem) has been selected to carry out the antifungal activity, presence of functional groups, and perform HPLC.

## MATERIALS AND METHODS

The plant, *C. auriculata* was gathered from Melmudi slopes in Coimbatore, Tamil Nadu, India in August 2023. The newly gathered leaves of the plant were painstakingly washed with running tap water and afterward flushed with sterile distilled water. Washed plant material was concealed drying under room temperature at 35°C for about 14 days. In the wake of drying, the plant leaves are cut into little pieces and pummelled in an electrical blender into a fine powder, and afterward moved into an impenetrable holder for additional examinations. Powdered plant material was utilized for the readiness of dissolvable concentrates. Methanol, hexane, and chloroform solvents were utilized for the extraction of plant material. A 50 g of powdered leaves were removed with methanol, hexane, and chloroform dissolvable independently in Soxhlet contraption at 40-50°C and kept for 48 hours. Each time before separating with the following dissolvable, the powdered material was dried. The rough concentrate was gotten by vanishing the solvents.

### Determination of the antifungal activity of plant extract

This test was carried out according to the method [19]. The plates were inoculated with 5 days old inoculums, which were swabbed over the entire surface of the Sabouraud Dextrose Agar (SDA) medium, rotating the plate 60 degrees after each application by using a sterile cotton swab, to ensure the spread of the tested microbes on the surface of the plate completely. Inoculums were 108 CFU/mL of bacteria. The 6 mm diameter of the well was made with borer on the agar plates. Different concentrations of plant extract were filled in well with the help of a micropipette and one well filled with plant extract. The polymixin B (10 µg/mL) was added in one well as a standard and added 100 µL of the extract was in another well. Incubated the plate at 37°C for 4 days, and then observed the zone of inhibition.

### Minimum Inhibitory Concentration (MIC)

The test microorganisms used in this study included two strains of fungi: *A. niger* and *A. flavus*. The cultures were incubated at room temperature and were transferred to fresh media every 3-5 days for the yeasts and every 5-7 days for the molds.

### Microtiter plate-based assay

The antifungal activity of the Biokill (a product that is safe for humans and pets) solutions was assessed using a modified version of the microdilution techniques described [20]. The antifungal assay was performed using a sterile 96-well plate and the Minimal Inhibitory Concentration (MIC) value was determined to estimate the antifungal activity. All the assays were prepared under aseptic conditions. Resazurin was used as an indicator of growth for the yeast assays, while the growth in the mold assays was inspected visually. The first step of the assay was adding 50 µL of sterile Sabouraud Dextrose Broth (SDB) into the first four and the last two rows of the 96-well plate. The first four wells were used for the evaluation of the activity of the plant extracts, while the previous two wells served as a positive and negative control. The positive control confirmed the viability of the fungal culture, while the negative control verified the sterility of the working conditions and solutions. Using the micropipette, different concentrations of plant extract were added to each well (first 4 wells). Then, 5 µL of resazurin solution was added to each well, followed by adding 5 µL of fungal broth. Positive control (viability control) comprised 50 µL of SDB, 5 µL of resazurin (where necessary), and 5 µL of fungal suspension, while the negative control (sterility control) comprised 50 µL of SDB and 5 µL of resazurin (ever necessary). The microtiter plates were wrapped in sterile tinfoil to prevent contamination and were then incubated at room temperature for 3-5 days for the yeast assays and 5-7 days for the mold assays. A blue-colored solution indicated the growth inhibition in the test wells, while pale pink to colorless solution indicated microbial growth or absence of inhibition. In addition, the mold assays were inspected visually: a clear solution indicated the absence of growth while the visual indication of mycelia indicated microbial growth or absence of inhibition.





Sankara Vel et al.,

**Fourier-transform infrared spectroscopy (FTIR) analysis**

Fourier Transform Infrared Spectrophotometer (FTIR) is perhaps the most powerful tool for identifying the types of chemical bonds (functional groups) present in compounds. The wavelength of light absorbed is characteristic of the chemical bond, as seen in the annotated spectrum. By interpreting the infrared absorption spectrum, the chemical bonds in a molecule can be determined. The test plant's dried powder (ethanol extract) was used for FTIR analysis. To prepare translucent sample discs 1 mg of the dried powder was encapsulated in 10 mg of KBr pellet. The powdered sample of the pellet was loaded in an FTIR spectroscope (Shimadzu, Japan), with a Scan range from 400 to 4000  $\text{cm}^{-1}$  with a resolution of 4  $\text{cm}^{-1}$  [21].

**High-Performance layer-Chromatography (HPLC)**

HPLC was performed on a Shimadzu Technologies modular model Class VP system consisting of an SCL-10A system, a UV-vis SPD-10A detector, LC-10 AD, and auto-injector SIL-10A (Shimadzu, Japan). The analysis was carried out using a BDS Hypersil C18 column (250×4.6 mm, i.d. 5  $\mu\text{m}$ ) (Thermo Fisher Scientific Inc., USA) with a BDS Hypersil C18 guard column (10×4 mm, i.d. 5  $\mu\text{m}$ ) (Thermo Hypersil-Keystone, USA). The isocratic mobile phase was 0.5% aqueous acetic acid solution and methanol (40:60). The total running time was 30 min and the flow rate was 1.0  $\text{mL min}^{-1}$ . The UV detector was monitored at 435 nm while the injection volume was 20  $\mu\text{L}$  [22].

**RESULTS AND DISCUSSION****Antifungal activity**

The present study tested the common fungus *A. niger* and *A. flavus* for antimicrobial activity with the Methanol, Chloroform, and Hexane extracts of *C. auriculata*. Table 1 indicates the Antifungal activity of Methanol extract. It shows the highest zone of inhibition in 4mg concentration with a 17mm zone of inhibition for *A. niger* and *A. flavus* zone of inhibition was 14 mm in 4 mg concentrations. Antifungal activity in chloroform extract is tabulated (Table 2). It shows the highest zone of inhibition in 4 mg concentration with a 19 mm zone of inhibition for *A. niger* and no zone of inhibition was seen in *A. flavus* at any of the concentrations. Table 3 indicates the antimicrobial activity in Hexane extract. It shows no zone of inhibition in both *A. niger* and *A. flavus* at any of the concentrations. MIC-Minimal Inhibition of concentration of microorganism was summarized in Table 4. The MIC values of different organisms varied differently. The Methanol extract showed a positive response in 0.5, 0.25, and 0.125 concentrations, the Chloroform extract showed a positive response in 1.5, 1, 0.5, 0.25 concentrations, and the Hexane extract showed no reaction in any concentration for *A. niger*. Only methanol extract showed a positive response in 1.5, 1, 0.5, and 0.25 for *A. flavus* (Table 5).

**Determination of MIC for fungal isolates**

The antimicrobial activity of the Hexane, Chloroform and Methanol extracts of *C. auriculata* were tested against *A. niger* and *A. flavus* by disc diffusion method. It was found that the plant extracts exhibited appreciable antimicrobial activity. The results were compared with the antimicrobial activities of antibiotics that were maintained as positive controls. The antimicrobial activity against *A. niger* and *A. flavus* was tested for one antibiotic disc, two concentrations of hexane, chloroform, and methanol extracts. The results are presented in the figure and the table. The methanol extract from the leaves of *Cassia fistula* L. had 100% antifungal activity at 10 mg/mL against *Trichophyton rubrum*, *Microsporium gypseum*, and *Penicillium marneffeii* [23]. Methanol extracts exhibited a higher degree of antimicrobial activity as compared with hexane extracts. Methanol extracts of *Albizia procera*, *C. auriculata* [24]. Among various fungi including species of *Aspergillus* causing significant loss in seed quality and nutritional quality of grains have been reported [25]. The antimicrobial activity of *Cassia didymobotrya* Fresen. leaf extracts were distilled water, methanol, and ethyl acetate. Three different concentrations were applied to the disc (100  $\mu\text{g}$ , 250  $\mu\text{g}$ , and 500  $\mu\text{g}/\text{disc}$ ) for each extract. The methanol and ethyl acetate extracts were more efficient compared to the aqueous extract. The inhibition zone diameter was seen to increase with the concentration [26]. The aqueous, n-hexane, and methanol extracts of *C. fistula* were analyzed against *Candida albicans* and *Saccharomyces cerevisiae* for antifungal activity. Antifungal activity was performed by the agar well diffusion method. In this method, all extracts



**Sankara Vel et al.,**

of *C. fistula* were tested against two fungal strains. Nystatin was used as a standard. As indicated by the zone of inhibition the highest antifungal activity of methanolic extract (2.6-3) was shown by *S. cerevisiae* [27]. The minimum inhibitory concentration (MIC) values for bacteria and yeast ranged from 3.1 to 6.2 mg/mL [28]. Leaves extracts of *Cassia occidentalis* L. were screened for their antimicrobial activity. The most susceptible microorganism was *Pseudomonas aeruginosa* (18 mm zone of inhibition in aqueous extract) followed by *Proteus mirabilis* at 15 mm zone of inhibition in methanol extract and *C. albicans* at 8 mm zone of inhibition in methanol extract [29]. The leaf extractives of *Cassia alata* L. leaves showed a range of activity against all the tested bacteria and fungi. The methanolic extracts of *C. alata* exhibited very strong activity against two bacteria and five fungi with maximum activity [30].

#### Fourier-Transform Infra-Red Spectroscopy (FT-IR)

The FTIR spectrum was used to identify the functional groups of the active components present in the leaf extract based on the peak values in the region of IR radiation. When the leaf extract was passed into the FTIR, the functional groups of the components were separated based on their peak ratio. The results of FTIR peak values and functional groups are represented in Table 6. The FTIR spectrum profile was illustrated in Figure 4. The FTIR gave a strong broad peak at 3328  $\text{cm}^{-1}$  which indicated the presence of O-H stretching. The FTIR gave Weak broad peaks at 2923  $\text{cm}^{-1}$  and 1647  $\text{cm}^{-1}$  which indicated the presence of O-H stretching and C=C 73791 stretching. The FTIR gave a medium peak at 1451  $\text{cm}^{-1}$  which indicated the presence of C-H bending. Finally, the FTIR gave an aliphatic ether peak at 1158  $\text{cm}^{-1}$  which indicated the presence of C-O stretching.

#### FT-IR analysis of *Cassia auriculata* stem extract

The FTIR spectrum was used to identify the functional groups of the active components present in the stem extract based on the peak values in the region of IR radiation. When the extract was passed into the FTIR, the functional groups of the components were separated based on their peak ratio. The results of FTIR peak values and functional groups are represented in Table 7. The FTIR spectrum profile is illustrated in Figure 5. The FTIR gave a strong broad peak at 3395  $\text{cm}^{-1}$  which indicated the presence of O-H stretching. The FTIR gave a Weak broad peak at 2990  $\text{cm}^{-1}$ , 2928  $\text{cm}^{-1}$ , and 2733  $\text{cm}^{-1}$  which indicated the presence of O-H stretching. The FTIR gave a medium peak at 1614  $\text{cm}^{-1}$  which indicated the presence of C=C 73791 stretching. The FTIR gave Alky aryl ether peak at 1234  $\text{cm}^{-1}$  which indicated the presence of C-O stretching. The FTIR gave an aliphatic ether peak at 1161  $\text{cm}^{-1}$  which indicated the presence of C-O stretching.

#### High-Performance Layer-Chromatography (HPLC)

HPLC profile for the methanol extract of *C. auriculata* was recorded. The extracts were run along with the standard myricetin. The leaf and stem extracts show the presence of myricetin in the peak graph. The R<sub>f</sub> value of the leaves extract was found to be 0.39, 0.44, 0.56, 0.63, 0.74, 0.78, 0.92, 0.97 of peak 1, 2, 3, 4, 5, 6, 7, 8 respectively. Among them, peak 4 is found as myricetin. The peak height and area percentages are tabulated (Table 8). The R<sub>f</sub> value of the stem extract was found to be 0.43, 0.23, 0.32, 0.45, 0.54, 0.63, 0.71, 0.77, 0.82 of peak 1, 2, 3, 4, 5, 6, 7, 8, 9 respectively. Among them, peak 6 is found as myricetin. The peak height and area percentages are tabulated (Table 9). To conclude, this study shows the dynamic variety of leaf and stems extracts of Hexane, Chloroform, and Methanol extract was used to evaluate the antimicrobial activity against *A. niger* and *A. flavus* showing the zone of inhibition of 25 mm and 20 mm respectively. The FTIR spectrum was used to identify the functional group of the active compounds present in both leaf and stem extracts. High-performance layer-chromatography (HPLC) was used to determine the presence of compound myricetin in stem and leaf extracts. Thus myricetin is considered a critical factor in antimicrobial activity agent to inhibit the growth of the organism which causes various fungal diseases.

#### ACKNOWLEDGEMENTS

The authors are grateful to acknowledge the PG & Research Department of Botany, PSG College of Arts & Science College, Coimbatore, India for providing necessary facilities during the study. This research did not receive any specific grant from funding agencies in the public, commercial, or not-for-profit sectors. The author declares



**Sankara Vel et al.,**

no conflict of interest associated with this publication and there has been no significant financial support for this work that could have influenced its outcome.

**Declaration of Competing Interest**

The authors declare that they have no known competing financial interests or personal relationships that could have appeared to influence the work reported in this paper

**REFERENCES**

1. Ncube NS, Afolayan AJ, Okoh AI. 2008. Assessment techniques of antimicrobial properties of natural compounds of plant origin: current methods and future trends. *Afr J Biotechnol* 7: 1797-1806. DOI: 10.5897/AJB07.613.
2. Satish S, Raveesha KA, Janardhana GR. 1999. Antibacterial activity of plant extracts on phytopathogenic *Xanthomonas campestris* pathovars. *Lett Appl Microbiol* 28: 145-147. DOI: 10.1046/j.1365-2672.1999.00479.x.
3. Okigbo RN, Ogbonnaya UO. 2006. Antifungal effects of two tropical plant leaf extracts (*Ocimum gratissimum* and *Aframomum melegueta*) on postharvest yam (*Dioscorea spp.*) rot. *Afr J Biotechnol* 5: 727-731.
4. Kumar RS, Ponmozhi M, Viswanathan P, Nalini N. 2002. Effect of *Cassia auriculata* leaf extract on lipids in rats with alcoholic liver injury. *Asia Pac J Clin Nutr* 11: 157-163. DOI: 10.1046/j.1440-6047.2002.00286.x.
5. Latha M, Pari L. 2003. Antihyperglycaemic effect of *C. auriculata* in experimental diabetes and its effects on key metabolic enzymes involved in carbohydrate metabolism. *Clin Exp Pharmacol Physiol* 30: 38-43. DOI: 10.1046/j.1440-1681.2003.03785.x.
6. Handa SS. 2008. An overview of extraction techniques for medicinal and aromatic plants. *Extraction Technol Med Aromat Plants* 1: 21-40.
7. Latgé JP. 1999. *Aspergillus fumigatus* and aspergillosis. *Clin Microbiol Rev* 12: 310-350. DOI: 10.1128/CMR.12.2.310.
8. Galvano F, Galofaro V, Ritieni A, Bognanno M, De Angelis A, Galvano G. 2001. Survey of the occurrence of aflatoxin M1 in dairy products marketed in Italy: the second year of observation. *Food Addit Contam* 18: 644-646. DOI: 10.1080/02652030118086.
9. Lacey E. 1988. The role of the cytoskeletal protein, tubulin, in the mode of action and mechanism of drug resistance to benzimidazoles. *Int J Parasitol* 18: 885-936. DOI: 10.1016/0020-7519(88)90175-0.
10. Trainor LJ, Austin CM, Desjardins RN. 2000. Is infant-directed speech prosody a result of the vocal expression of emotion? *Psychol Sci* 11: 188-195. DOI: 10.1111/2F1467-9280.00240.
11. Adam, K., Sivropoulou, A., Kokkini, S., Lanaras, T., and Arsenakis, M., 1998. Antifungal activities of *Origanum vulgare* subsp. *hirtum*, *Mentha spicata*, *Lavandula angustifolia*, and *Salvia fruticosa* essential oils against human pathogenic fungi. *Journal of Agricultural and Food Chemistry*, 46(5), pp.1739-1745.
12. Allwood JW, Ellis DI, Goodacre R. 2008. Metabolomic technologies and their application to the study of plants and plant-host interactions. *Physiol Plant* 132 (2): 117-135. DOI: 10.1111/j.1399-3054.2007.01001.x.
13. Sim CO, Hamdan MR, Ismail Z, Ahmad MN. 2004. Assessment of herbal medicines by chemometrics assisted interpretation of FTIR spectra. *J Anal Chim Acta* 1: 1-14.
14. Li YM, Sun SQ, Zhou Q, Qin Z, Tao XJ, Wang J, Fang X. 2004. Identification of American ginseng from different regions using FT-IR and two-dimensional correlation IR spectroscopy. *Vibrational Spectrosc* 36: 227-232. DOI: 10.1016/j.vibspec.2003.12.009.
15. Kumar JK, Prasad AD. 2011. Identification and comparison of biomolecules in medicinal plants of *Tephrosia tinctoria* and *Atylosia albicans* by using FTIR. *Rom J Biophys* 21: 63-71.
16. Rivier L, Crozier A. 1987. *Biological Techniques Series*. London.
17. Pan X, Wang X. 2009. Profiling of plant hormones by mass spectrometry. *J Chromatogr B* 877 (26): 2806-2813. DOI: 10.1016/j.jchromb.2009.04.024.
18. Reinhold L, Harborne JB, Swain T. 2016. *Progress in Phytochemistry*. Elsevier.





Sankara Vel et al.,

19. Khan, J. A., & Hane, S. (2011). Antibacterial properties of Punica granatum peel. *International Journal of Applied Biology and Pharmaceutical Technology*, 2(3), 23-27.
20. Drummond AJ, Waigh RD. 2000. The development of microbiological methods for phytochemical screening. *Recent Res Dev Phytochem* 4: 143-152.
21. Maitera ON, Chukkol IB. 2016. Phytochemical and Fourier transform infrared spectroscopy analysis of *Faidherbia albida* (Del) as a preservative agent. *World J Res Rev* 3 (3): 25-29.
22. Chewchinda S, Sakulpanich A, Gritsanapan PS. 2012. HPLC analysis of laxative rheine content in *Cassia fistula* fruits of different provenances in Thailand. *Thai J Agric Sci* 45: 121-125.
23. Phongpaichit S, Pujenjob N, Rukachaisirikul V, Ongsakul M. 2004. Antifungal activity from leaf extracts of *Cassia alata* L., *Cassia fistula* L. and *Cassia tora* L. *Songklanakarini J Sci Technol* 26: 741-748.
24. Voravuthikunchai S, Lortheeranuwat A, Jeeju W, Sririrak T, Phongpaichit S, Supawita T. 2004. Effective medicinal plants against enterohaemorrhagic *Escherichia coli* O157: H7. *J Ethnopharmacol* 94: 49-54. DOI: 10.1016/j.jep.2004.03.036.
25. Koirala P, Kumar S, Yadav BK, Premarajan KC. 2005. Occurrence of aflatoxin in some of the food and feed in Nepal. *Indian J Med Sci* 59: 331-336. DOI: 10.4103/0019-5359.16649.
26. Singh SA, Singh NR. 2010. Antimicrobial activity of *Cassia didymobotrya* and *Phlogacanthus thyriflorus*. *J Chem Pharm Res* 2 (4): 304-308.
27. Hussain S. 2017. A study on the antifungal potential of *Cassia fistula* Linn. [Doctoral dissertation]. University of Management & Technology.
28. Hamad GM, Darwish AM, Abu-Serie MM, El Sohaimy SA. 2017. Antimicrobial, antioxidant, and anti-inflammatory characteristics of combination (*Cassia fistula* and *Ocimum basilicum*) extract as a natural preservative to control & prevent food contamination. *J Food Nutr Res* 5 (10): 771-780. DOI: 10.12691/jfnr-5-10-8.
29. Arya V, Yadav S, Kumar S, Yadav JP. 2010. Antimicrobial activity of *Cassia occidentalis* L (leaf) against various human pathogenic microbes. *Life Sci Med Res* 9 (1): 1-12.
30. Makinde AA, Igoli JO, Ta'Ama L, Shaibu SJ, Garba A. 2007. Antimicrobial activity of *Cassia alata*. *Afr J Biotechnol* 6 (13).

Table 1. Antifungal activity in methanol extract of *Cassia auriculata*

Types of extract	Isolates	Concentration of plant extracts (mg)				
		Zone of inhibition in mm				
		1 mg	2 mg	3 mg	4 mg	Polymixcin B (control)
Methanol	<i>Aspergillus niger</i>	11	13	15	17	-
	<i>Aspergillus flavus</i>	-	10	12	14	-

Table 2. Antifungal activity in chloroform extract of *Cassia auriculata*

Types of extract	Isolates	Concentration of plant extracts (mg)				
		Zone of inhibition in mm				
		1mg	2mg	3mg	4mg	Polymixcin B (Control)
Chloroform	<i>Aspergillus niger</i>	12	14	16	19	-
	<i>Aspergillus flavus</i>	-	-	-	-	-

Table 3. Antifungal activity in the hexane extract of *Cassia auriculata*.

Types of extract	Isolates	Concentration of plant extracts (mg)				
		Zone of inhibition in mm				
		1mg	2mg	3mg	4mg	Polymixcin B (Control)
Hexane	<i>Aspergillus niger</i>	-	-	-	-	-
	<i>Aspergillus flavus</i>	-	-	-	-	-





Sankara Vel et al.,

Table 4. Determination of MIC for fungal isolates.

Types of extract	Isolates	Concentration of plant extracts (mg)					Polymixin B (Control)
		Zone of inhibition in mm					
		1	0.5	0.25	0.125		
Methanol	<i>Aspergillus niger</i>	-	+	+	+		-
Chloroform	<i>Aspergillus niger</i>	-	+	+	+		-

Table 5. Determination of MIC for fungal isolates

Types of extract	Isolates	Concentration of plant extracts (mg)					Polymixin B (Control)
		Zone of inhibition in mm					
		2	1.5	1	0.5	0.25	
Methanol	<i>Aspergillus flavus</i>	-	+	+	+	+	-

Table 6. FTIR peak values and functional groups of *Cassia auriculata* (leaf).

S.No	Absorption (cm <sup>-1</sup> )	Bond	Functional Group	Appearance of peak
1	3328	O-H stretching	Alcohol, phenols	Strong, broad
2	2923	O-H stretching	Alcohol, phenols	Weak, broad
3	1647	C=C stretching	Alkenes	Weak, broad
4	1451	C-H bending	Alkenes	Medium
5	1158	C-O Stretching	Aliphatic ether	Medium

Table 7. FTIR peak values and functional groups of *Cassia auriculata* (stem).

S.No	Absorption (cm <sup>-1</sup> )	Bond	Functional Group	Appearance of peak
1	3395	O-H stretching	Alcohol, phenols	Strong, broad
2	2990, 2928, 2733	O-H stretching	Alcohol, phenols	Weak, broad
3	1614	C=C stretching	Alkenes	Medium
4	1234	C-O stretching	Alky aryl ether	Weak
5	1161	C-O Stretching	Aliphatic ether	Weak

Table 8. HPLC analysis of *Cassia auriculata* leaf.

Peak	Rf value	Height	Area %	Assigned Substance
1	0.39	13.0 AU	2.16%	Unknown
2	0.44	15.6 AU	5.59%	Unknown
3	0.56	14.6 AU	2.19%	Unknown
4	0.63	68.3 AU	57.07%	Myricetin
5	0.74	2.5 AU	1.80%	Unknown
6	0.78	8.6 AU	3.09%	Unknown
7	0.92	1.6 AU	1.11%	Unknown
8	0.97	1.7 AU	1.44%	Unknown

Table 9. HPLC analysis of *Cassia auriculata* stem.

Peak	Rf value	Height	Area %	Assigned Substance
1	0.23	9.0 AU	14.16%	Unknown
2	0.32	7.6 AU	12.59%	Unknown
3	0.43	9.6 AU	17.19%	Unknown
4	0.45	5.3 AU	112.07%	Unknown
5	0.54	21.5 AU	17.80%	Unknown
6	0.63	58.6 AU	63.09%	Myricetin





Sankara Ve et al.,

7	0.71	24.6 AU	18.11%	Unknown
8	0.77	6.6 AU	12.04%	Unknown
9	0.82	4.2 AU	11.4%	Unknown

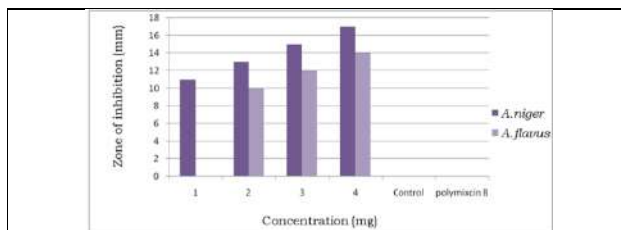


Figure 1. Zone of inhibition in methanol extract

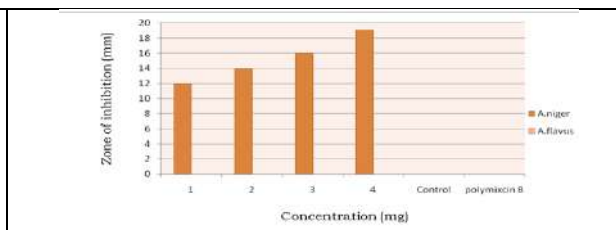


Figure 2. Zone of inhibition in chloroform extract.

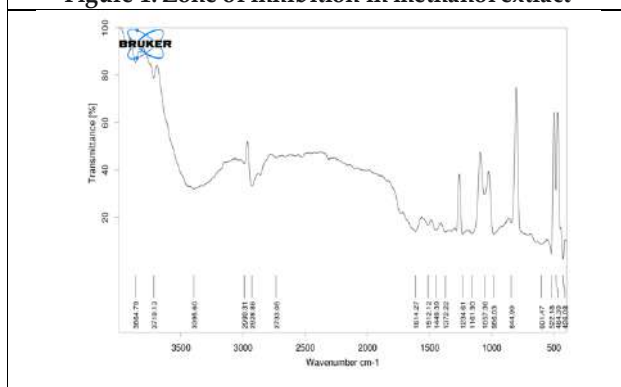


Figure 3. FT-IR spectrum of Leaf extract.

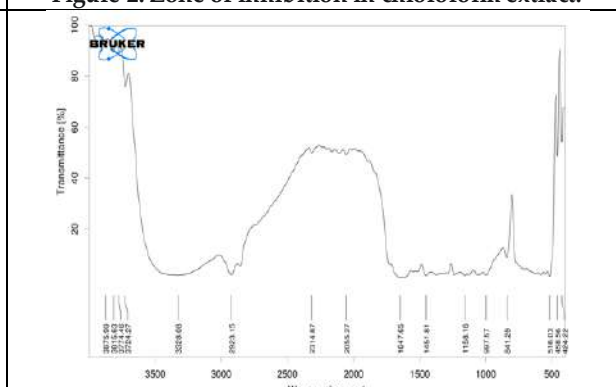


Figure 4. FT-IR spectrum of stem extract.







## Relationship of Body Mass Index with Agility in Female Kabaddi Players : A Cross Sectional Study

Chakshu Mehta\*

Assistant Professor, College of Physiotherapy, Sumandeep Vidyapeeth (Deemed to be University), Gujarat, India.

Received: 30 Jan 2024

Revised: 09 Feb 2024

Accepted: 26 Apr 2024

### \*Address for Correspondence

**Chakshu Mehta**

Assistant Professor,  
College of Physiotherapy,  
Sumandeep Vidyapeeth (Deemed to be University),  
Gujarat, India.

Email: chakshu44m@gmail.com



This is an Open Access Journal / article distributed under the terms of the **Creative Commons Attribution License** (CC BY-NC-ND 3.0) which permits unrestricted use, distribution, and reproduction in any medium, provided the original work is properly cited. All rights reserved.

### ABSTRACT

Contact sport Kabaddi requires a quick change in direction for better performance. The ability to move and change directions quickly in sports is denoted as agility. The aim of this study was to investigate the relationship of body mass index (BMI) with agility in female kabaddi players. The cross-sectional study included a total of 60 female players between 18 to 25 years, from various sports settings from Vadodara, Gujarat. The BMI was calculated using a standard formula and agility was assessed using T-test. To find out the relationship between variables, Pearson coefficient of correlation was calculated. The study found significantly positive correlation between agility and Height ( $r=0.28$ ,  $p<0.05$ ), but there was significantly negative correlation between agility and weight ( $r=-0.29$ ,  $p<0.05$ ) and agility and BMI ( $r=-0.41$ ,  $p<0.05$ ). In conclusion, agility is directly related to height but inversely related to weight and BMI in the female kabaddi players in the age group of 18 to 25 years.

**Keywords:** Height, Weight, BMI, Agility, Kabaddi

### INTRODUCTION

Kabaddi is an attacking and defensive game that requires agility, power, endurance, strength and skill. In a contact sport like kabaddi, players have to be physically fit to give their optimal performance(1–3). Agility refers to the ability to change direction rapidly and accurately. This requires good balance, strength and speed (4). Improved agility provides increased body control during fast movements, increased intramuscular coordination, and decreased risk of injury or reinjury (5). Various studies have found a relationship between weight, height, BMI and some elements of physical fitness such as agility, speed and balance in various age groups(3,6,7). As far as we know, no study has



**Chakshu Mehta**

been done that establishes the relationship between BMI and agility, specifically in Kabaddi players of age group 18-25 years. Therefore, the study aims to fill this vacuum in the literature.

**METHODOLOGY**

The cross-sectional study included a total of 60 female kabaddi players, aged 18 to 25, who have been playing for at least 1 month at various sports settings in Vadodara, Gujarat. Ethics committee approval for parent study was obtained by the Institutional Ethics Committee for Biomedical and Health Research for the study (Approval no. IECBHR/108-2021, Date. 22/06/2021). The data was collected from November 2020 to April 2021. The study excluded players who had current lower limb, spinal cord injury, or deficit (musculoskeletal, neurological, or cardiovascular). Following variables such as; height, weight, BMI and agility were studied. Weight and height were assessed using weighing scale and stature meter, respectively. BMI was calculated as weight in kilograms divided by the square of height in meters. Agility was assessed using on field T-test. Various methods are used to test agility but T-test has become popular because it is relatively simple to perform and requires minimal equipment and preparation. The T-test is described as a measure of 4-directional agility and body control that evaluates the ability to change directions rapidly while maintaining balance without loss of speed (5,8,9). The relationship between the variables was studied using MedCal statistic software version 20.106. Coefficient of correlation was calculated at 95% confidence interval.

**RESULTS**

The study included total 60 female kabaddi players. The mean age of all 60 female kabaddi players was 20.88 years and mean BMI was 24.57 kg/m<sup>2</sup>. The characteristics of the players are displayed in Table 1. The correlation between BMI and agility was found using Pearson coefficient of correlation. As displayed in Table 2, agility was found to have a negative correlation with BMI with p value 0.001. But agility was found to have positive correlation with height with p value 0.029. The graphical presentation of correlation between BMI and agility is displayed by scatter diagram in Figure 1.

**DISCUSSION**

The aim of the present study was to find a relationship between BMI and agility in female kabaddi players. The study done by Dr. Mahesh and Dr. Bharat in 2017 assessed the relationship between body mass index and agility and speed of 46 university players and found a significant relationship between weight and agility ( $r = 0.670$ ,  $p < 0.05$ ), weight and speed ( $r = 0.543$ ,  $p < 0.05$ ), BMI and agility ( $r = 0.546$ ,  $p < 0.05$ ), and BMI and speed ( $r = 0.752$ ,  $p < 0.05$ ). There was no significant correlation found between height and agility ( $r = 0.164$ ,  $p > 0.05$ ) and height and speed ( $r = 0.065$ ,  $p > 0.05$ ) (7). Hariadi et. al. (2019) studied relationship between body mass index with agility of elementary school children and found no significant relationship between two (6). Additionally, they even found no significant relationship between agility and BMI in both girls and boys. Moreover, main factors that influence agility are speed, strength, coordination and balance rather than BMI (6). Hence, the relationship of other influencing factors should also be studied. In contrast, this study found a positive relationship between agility and height, but negative relationship between agility and weight or agility and BMI. The finding of this study suggests that player with higher body height, lower body weight and ultimately lower body mass index are likely to have good agility. The findings are identical to those of a study done by Marek et al. in 2022 on 31 elite female athletes. They found that female players with higher body height obtained a shorter total time for the agility test (10). The small number of participants could be the limiting factor for the statistical approach. These findings could be particularly relevant for the age group of 18 to 25 years only. To get a broader picture, the same study can be conducted with a larger sample size, including various age groups from various parts of the country. This should be taken into account in future research.





**Chakshu Mehta**

## CONCLUSION

In conclusion, Players with higher BMI are likely to be less agile as agility is found to have inverse relationship with body mass index in the female kabaddi players in the age group of 18 to 25 years.

## ACKNOWLEDGEMENTS

The author expresses sincere gratitude to Dr. Sweta Shah (PT), senior lecturer, college of physiotherapy, SSG hospital, Vadodara for her valuable time and expertise.

## REFERENCES

1. Rao CV, Kishore Y. Correlations of Biomechanical Characteristics with Ball Speed in Penalty Corner Push-In Combined Effect of Strength and Plyometric Training Programme on Selected Motor Fitness Components of Male Kabaddi Players. Vol. 1, International Journal of Recent Research and Applied Studies. 2014.
2. Pal S, Kalra S, Kumar S, Pawaria S, Rishi P. A Literature Review on Common Injuries and Their Prevention in Kabaddi A Literature Review on Common Injuries and Their Prevention in Kabaddi. 2020;9(1).
3. Ks SK, Sudhakara G. Selected physical fitness components and Kabaddi performance. Int J Acad Res Dev. 2018;3(2).
4. Gajanana Prabhu B, Swamy SN. An appraisal of agility in athletes engaged in indigenous and non-indigenous games of India. Journal of Physical Education and Sport [Internet]. 2013 [cited 2023 Apr 18];13:621624. Available from: 10.7752/jpes.2013.04098
5. Michele A., Raya, Robert S. Gailey, Ignacio A. Gaunard, Daniel M. Jayne. Comparison of three agility tests with male servicemembers: Edgren Side Step Test, T-Test, and Illinois Agility. J Rehabil Res Dev [Internet]. 2013 [cited 2023 Apr 18];50(7):951–60. Available from: 10.1682/JRRD.2012.05.0096
6. Hariadi I, Riyad Fadhli N, Sandy Yudasmara D. Relationship Between Body Mass Index (BMI) With Agility of Elementary School Children. In Atlantis Press; 2019.
7. Singh Dhapola M, Verma B. Relationship of body mass index with agility and speed of university players. International Journal of Physical Education, Sports and Health [Internet]. 2017;4(2):313–5. Available from: www.kheljournal.com
8. Madole K, Garhammer J, Lacourse M, Rozenek R, Education P, State C, et al. Reliability and validity of the t-test as a measure of agility, leg power, and leg speed in college-aged men and women. J Strength Cond Res [Internet]. 2000;14:443–50. Available from: 10.1519/00124278-200011000-00012
9. Robert wood. topend sports website. 2008 [cited 2023 Apr 18]. T-Test of Agility. Available from: <https://www.topendsports.com/testing/tests/t-test.htm>
10. Popowczak M, Horička P, Šimonek J, Domaradzki J. The Functional Form of the Relationship between Body Height, Body Mass Index and Change of Direction Speed, Agility in Elite Female Basketball and Handball Players. Int J Environ Res Public Health. 2022 Nov 1;19(22).

**Table 1. Characteristics of Players**

Variables	Mean±SD
Age (years)	20.88±2.18
Height (meters)	1.58±0.04
Weight (kilograms)	61.51±6.30
BMI (Kg/m <sup>2</sup> )	24.57±2.84
Agility (seconds)	12.56±1.06

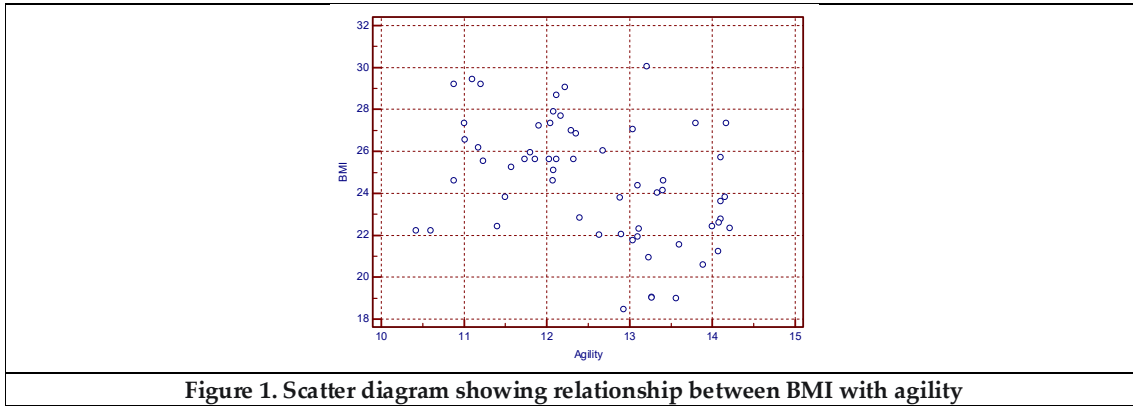




**Chakshu Mehta**

**Table 2. Relationship of BMI with agility**

Variable	Coefficient of correlation	P value
Height	0.281	0.029
Weight	-0.295	0.022
BMI	-0.405	0.001





## Experimental and Theoretical Investigation of DNA Interaction and *In-vitro* Antitumor Activity of Copper (II) and Cobalt (II) Complexes Containing Monobasic Bidentate Schiff Base Ligands

N.Sathya<sup>1</sup>, Franklin Ebenazer<sup>2</sup> and M.Sujatha<sup>3\*</sup>

<sup>1</sup>Assistant Professor, Department of Chemistry, Chikkanna Government Arts College, Tirupur (Affiliated to Bharathiar University, Coimbatore) Tamil Nadu, India.

<sup>2</sup>Research Associate, Department of Chemistry, Chikkanna Government Arts College, Tirupur (Affiliated to Bharathiar University, Coimbatore) Tamil Nadu, India.

<sup>3</sup>Associate Professor, Department of Chemistry, Chikkanna Government Arts College, Tirupur (Affiliated to Bharathiar University, Coimbatore) Tamil Nadu, India.

Received: 17 Jan 2024

Revised: 09 Feb 2024

Accepted: 26 Apr 2024

### \*Address for Correspondence

**M.Sujatha**

Associate Professor,  
Department of Chemistry,  
Chikkanna Government Arts College,  
Tirupur (Affiliated to Bharathiar University, Coimbatore)  
Tamil Nadu, India.  
Email: muthusamysujatha7@gmail.com



This is an Open Access Journal / article distributed under the terms of the **Creative Commons Attribution License** (CC BY-NC-ND 3.0) which permits unrestricted use, distribution, and reproduction in any medium, provided the original work is properly cited. All rights reserved.

### ABSTRACT

Here we synthesize *o*-vanillin Schiff base ligand L1 and its Co(II) and Co(II) metal complexes were synthesized and characterized by elemental analysis, UV, IR, <sup>1</sup>H NMR and <sup>13</sup>C NMR analysis. The DNA binding activity of the ligands and complexes investigated by absorption spectroscopy revealed that the complexes bind to DNA through a partial intercalation mode. the binding affinity of complex L1-Co is greater than that of the ligand L1 and the complex L1-Cu. Both complexes were carefully investigated *in-vitro* for cytotoxicity against MCF-7, and HT-29 cells. The complex L1-Cu, with an IC<sub>50</sub> value (20.35 μM) has exhibited a higher cytotoxicity profile than compound L1-Co against selected cancer cell lines tested. The *in-silico* density functional theory (DFT) calculation reveals the structural geometry and its electronic and biological parameters and molecular docking of ligands and the complexes interacting with DNA through partial intercalation at the major intercalation binding supports the experimental results. Further, ADME analysis shows drug-like properties of both the ligand and its complexes which predicts that it might be a potential candidate for anticancer drugs.

**Keywords:** Schiff base; Anticancer Drug; DNA binding; MTT; DFT Study; Docking





Sathya et al.,

## INTRODUCTION

Designing new metal-based cancer chemotherapeutic agents is a leading research area of inorganic medicinal chemistry [1]. Novel drugs are being invented to treat a wide range of cancers [2]. Although some of the first-generation metal-based drugs were promising against most of the cancer cell lines, they lack specificity and show cytotoxicity to normal cells. For example, cisplatin, the well-known platinum-based anticancer drug suffers from resistance developed by cancerous cells besides considerable toxicity [3]. Deoxyribonucleic acid is the most common target for the treatment of health conditions arising out of gene-level disorders including cancer. Thus, the DNA-binding capability of a compound is one of the main criteria for its use as an antitumor drug [4]. In transition metal complexes, the presence of the azomethine ( $>C=N$ ) group is believed to be responsible for the wide application in many pharmacological activities like antibacterial, antifungal, antitumor, antiproliferative, and antipyretic properties [5–7]. Pyrimidine is one of the most important nitrogen-containing heterocyclic compounds that exhibit remarkable biological activity. Schiff base ligands and their complexes show catalytic activity in many reactions [8–11]. Most of the transition metal schiff base complexes have been prepared from Schiff bases containing O, and N donor atoms. The number and relative position of donor atoms in pyrimidine derivatives govern their reactivity [12]. Keeping the above information in mind, this paper discusses the synthesis and characterization of four mononuclear Co(II) and Cu(II) complexes containing Schiff base ligands derived from the condensation of 2-amino-4-methoxy-6-methyl pyrimidine with *o*-vanillin (L1) (**Scheme 1**). The ligand L1 and its corresponding metal complexes have been subjected to DNA-binding studies using calf thymus (CT) DNA by monitoring their UV absorption. Further, the *in-vitro* anticancer potential of L1 and its copper and cobalt metal complexes have been investigated against MCF-7 and HT-29 cancer cell lines. All the experimental data were supported by the theoretical study such as DFT, Docking and ADME profile, etc.

## MATERIALS AND METHODS

The reagents triphenylphosphine, 4-methoxy-6-methylpyrimidin-2-amine, and 2-hydroxy-3-methoxybenzaldehyde were purchased from sigma, Aldrich, Both CoCl<sub>2</sub> and CuCl<sub>2</sub> metal salts were purchased from SD Fine chemicals. All solvents were purchased from Merck chemicals and used without further purifications. Elemental analyses were performed at the sophisticated test and instrumentation center (STIC), in Cochin, India. Infrared spectra of the ligands and complexes were recorded as KBr pellets in the 4000-400 cm<sup>-1</sup> region using Perkin Elmer FT-IR 8000 spectrophotometer. Electronic spectra of the ligands and complexes were recorded in dichloromethane solution with a Systronics double beam UV-vis spectrophotometer model UV-100 super space in the range 200-800 nm. <sup>1</sup>H-NMR and <sup>13</sup>C-NMR spectra were recorded at STIC, Cochin University of Science and Technology, Cochin.

### Synthesis and characterization of ligand and Complexes

Both the desired ligand L1 and its Co(II) and Cu(II) complexes were synthesized as shown in Scheme. 1. The free ligand L1 was synthesized by simple Schiff base condition, in the round bottom flask containing 0.2 gm (1 eq, 1.4 mM) of 4-methoxy-6-methylpyrimidin-2-amine with 0.22 gm (1 eq, 1.4 mM) of 2-hydroxy-3-methoxybenzaldehyde in 10 mL of methanol solution. Two drops of acetic acid were added as an acid catalyst to promote the reaction at room temperature. The progress of the reaction was monitored by TLC. After completing the reaction, the product was filtered and washed with cold methanol offering a yellow solid 84% yield. The complexes (L1-Co and L1-Cu) were synthesized by reacting 1 eq. (100 mg, 0.37 mM) of ligand, L1 was dissolved in 5 ml of ethanol and 5 ml of chloroform mixture, 1 equ. of (96 mg, 0.37mM) of triphenylphosphine co-ligand and 1 equ. CuCl<sub>2</sub>/CoCl<sub>2</sub> was added to a round-bottomed flask, and the reaction mixture was refluxed for 2 h at 65 °C. The solution transforms color change and precipitates the complex products. After filtering and solvent-washing the precipitate, offers the desired L1Co and L1-Cu complex with a yield of ~80%.





**Sathya et al.,**

### DNA Binding

The DNA binding experiment was performed with L1, L1-Co, and L1-Cu ( $5 \times 10^{-5}$  M) in Tris-HCl buffer (pH 7.4) in a water medium.[13] The concentration of CT-DNA was calculated spectrophotometrically at 260 nm using its molar absorption coefficient value  $6600 \text{ M}^{-1} \cdot \text{cm}^{-1}$ . Primarily, an equivalent amount of DNA (1 mL,  $2.87 \times 10^{-4}$  M) was added to both cuvettes (sample and reference) and chronologically added ligands to get absorption spectra of DNA-ligand interaction. Initially, the lead compound was equilibrated with CT-DNA for about 5 min. The intrinsic DNA binding constant ( $K_b$ ) was calculated using equation (i).

$$\frac{DNA}{(\varepsilon_a - \varepsilon_f)} = \frac{DNA}{(\varepsilon_b - \varepsilon_f)} + \frac{1}{K_b(\varepsilon_a - \varepsilon_f)} \quad (i)$$

Where  $\varepsilon_a$ ,  $\varepsilon_f$ , and  $\varepsilon_b$  are the apparent extinction coefficient for the complex, the extinction coefficient of the complex in its free form, and the extinction coefficient of the complex when fully bound to DNA respectively. The linear plot has been made by plotting  $[DNA]/(\varepsilon_a - \varepsilon_f)$  vs.  $[DNA]$ . The  $K_b$  value of the lead compound was calculated from the ratio of the slope and intercept.

### Cytotoxicity Assay

Each compound (L1, L1-Co, and L1-Cu) was dissolved in 0.1% DMSO and then serially diluted with DMEM medium containing 10% Fetal calf serum. Different cell lines such as MCF-7, and HT-29 were used in this assay. *Cis-platin* was used as a positive control. The entire cells were cultured in 100  $\mu\text{L}$  of a growth medium in 96-well plates and incubated at 37 °C under 5%  $\text{CO}_2$  overnight. After incubation time, the cultured cells were exposed to different concentrations of compounds (9-300  $\mu\text{M}$ ). Control cells were cultured with an equivalent amount of DMSO alone. After 24 h of incubation time, 100  $\mu\text{L}$  of MTT reagent (1 mg/mL) was added to each culture well and incubated for 3 h at 37 °C. After 3 h, the medium was discarded and formazan crystals formed in live cells were dissolved in 300  $\mu\text{L}$  DMSO and subsequently quantitated by measuring absorbance using a microplate reader at 620 nm. The experiment was also conducted in triplicate. The growth inhibition percentage was calculated using the equation (ii):

$$\% \text{ Inhibition} = 100 - \left[ \frac{AD \times 100}{AB} \right] \quad (ii)$$

where AD represents measured absorbance in wells that consists of samples and AB represents the absorbance of the blank wells.

### Computational Methods

All calculations were performed using the GAUSSIAN 09 program package with the aid of the GaussView visualization program.[14] The ground state geometries of L1, L1-Co, and L1-Cu were fully optimized using the hybrid B3LYP functional methods in combination with the 6-31G (d,p) basis set for lighter elements (C, H, N, O, and Cl) and LanL2DZ effective core potential for metals (Co and Cu).[15] All geometries were optimized to zero negative vibrational frequency to ensure the global minima.[16]

### Molecular Docking

The optimized structures of the ligand (L1) and complexes (L1-Co and L1-Cu) were performed using DFT/B3LYP used for the docking study as a ligand by converting it to pdb format. The crystal data of the B-DNA dodecamer d(CGCGAATTCGCG)<sub>2</sub> (PDB ID: 1BNA) were downloaded from the Protein Data Bank.[17] The water molecules and the ligands were removed from the 1BNA, and Gasteiger charges were added to the complexes by Pymol and Autodock 4.2 Tools (ADT) before performing docking calculations.[18] The binding site was centered on the DNA molecule and a grid box was created with 50×50×50 points which almost involved the entire DNA molecule. The rigid docking protocol and 100 runs of the Lamarckian genetic algorithm for searching ligand conformations were performed. The scoring functions obtained out of the process were screened to fix the conformer lying close to the active site residues and subsequently analysed for its binding pattern.





Sathya et al.,

### ADME Profile

All the compounds were checked for their drug likeness by generating data about molecular weight, number of hydrogen bond donors/acceptors, polar surface area, number of rotatable bonds, partition coefficient, etc. The study was carried out using an online web server named Swiss ADME (Molecular modeling group, Swiss Institute of Bioinformatics, Lausanne, Switzerland; www.swissadme.ch).[19]

## RESULTS AND DISCUSSION

A series of mononuclear complexes of the type  $[MCl(PPh_3)(L_1)]$  ( $M = Co/Cu$ ;  $L_1 =$  monobasic bidentate Schiff base ligands) was synthesized from the reaction between the appropriate metal precursor and the ligand  $L_1$  in chloroform and ethanol mixture (Scheme 1). All the Schiff base ligands and their  $Co(II)$  and  $Cu(II)$  complex were synthesized and characterized by NMR, FTIR, Elemental analysis, and absorbance spectral analysis.

### Spectral characterization of the ligands and complexes

IR spectral data (Table 1) of the ligands were compared with those of the metal complexes to ascertain the mode of binding. The ligands showed a peak around  $1630\text{ cm}^{-1}$ , ascribed to the azomethine ( $>C=N$ ) stretching. This characteristic peak underwent a negative shift ( $1576\text{-}1620\text{ cm}^{-1}$ ) revealing the coordination of azomethine nitrogen to the central metal ion [20]. The phenolic OH and C-O stretching [21] vibrations of the ligands are observed above  $3300\text{ cm}^{-1}$  and around  $1345\text{ cm}^{-1}$ , respectively. The absence of a phenolic O-H peak and shift of the C-O peak to higher wave numbers ( $1437\text{-}1480\text{ cm}^{-1}$ ) in the metal complexes indicate the coordination of phenolic oxygen after deprotonation. The appearance of a new peak around  $530\text{-}570\text{ cm}^{-1}$  is due to the metal-nitrogen bond stretching [22]. The  $^1H$ -NMR spectra of the ligands were recorded in  $DMSO-d_6$  using tetramethylsilane (TMS) as an international standard. The aromatic protons of the ligands resonated as a multiplet in the region  $5.69\text{-}7.54\text{ ppm}$ . The phenolic -OH proton appeared as a singlet around  $10.8\text{ ppm}$  and the imine proton resonated as a singlet around  $9.50\text{ ppm}$ , while the pyrimidine ring protons are seen as a singlet around  $6.4\text{ ppm}$  [23]. The other protons appeared at the expected regions (Fig. 1a). In the  $^{13}C$  NMR spectra, the azomethine carbon appears at  $161\text{ ppm}$ . The aromatic carbon peaks are found in the region  $119\text{-}148\text{ ppm}$  [24]. The pyrimidine methoxy and methyl carbon atoms show peaks in the region  $53.2\text{-}53.6\text{ ppm}$  and  $23.6\text{-}23.7\text{ ppm}$ , respectively. In  $L_1$ , the methoxy carbon appears at  $53.9\text{ ppm}$  and the carbon atom of the phenolic group appears at  $157\text{ ppm}$  [25].

### Electronic Spectroscopy

The electronic absorption spectral data of the free ligands and their metal complexes are supplied in Table 2. The ligand  $L_1$  exhibited 4 bands in the UV region  $226\text{-}354\text{ nm}$ , while  $L_2$  exhibited 4 bands in the UV region ( $225\text{-}284\text{ nm}$ ) and two bands in the visible region ( $430$  and  $453\text{ nm}$ ). The bands are attributed to  $\pi \rightarrow \pi^*$  and  $n \rightarrow \pi^*$  transitions in the aromatic ring and  $-C=N-$  chromophore [21]. The  $Cu(II)$  and  $Co(II)$  complexes showed  $\pi \rightarrow \pi^*$  and  $n \rightarrow \pi^*$  transitions in the range  $225\text{-}280\text{ nm}$  and  $295\text{-}316\text{ nm}$ , respectively. In the complexes, the bands at the visible region can be safely assigned to ligand-to-metal charge transfer transitions according to a reported work [26]. The nature of the spectra suggests a square planar environment around the  $Co(II)$  and  $Cu(II)$  metal centers.

### DNA Interaction Studies

Studying the DNA binding of a drug candidate is a good starting point for the assertion of the compound as an anticancer drug, although there are many other mechanisms through which a drug can exhibit anticancer activity. Literature shows that the DNA-binding ability of metal-based drugs has served as the basis to develop anticancer drugs or prodrugs. Among the various classes of metals,  $d$ -block metals are studied with a special interest in this regard due to their electrochemical and photophysical properties [25,27]. DNA binding can be monitored by various spectroscopic and physical methods. An elementary, convenient, and robust method is conducting an absorption titration. A compound can bind into DNA through three major modes: electrostatic interaction, groove binding, and intercalation. The modes of binding can be inferred from the shift in the absorption and intensity of a particular







Sathya et al.,

absorption peak. Compounds that bind to DNA through intercalation binding mode show an increase in the intensity and a small bathochromic or hypochromic shift in the spectrum. In the absorption titration experiment, significant changes in the absorption maximum and intensity are noted. The spectroscopic changes suggested that the ligand and complexes interacted with DNA [28]. The ligand L1, L1-Co and L1-Cu complexes show intercalating binding with the base pairs of DNA [29,30]. To confirm the binding of ligands and complexes with DNA quantitatively, the binding constant ( $k_b$ ) of ligands and complexes was obtained from the changes in the absorbance peak [32]. As shown in Fig. 2, the binding affinity of complex L1-Co ( $K_a = 4.1 \times 10^4 \text{ M}^{-1}$ ) is greater than that of the ligand L1 ( $K_a = 2.8 \times 10^3 \text{ M}^{-1}$ ), and the complex L1-Cu ( $K_a = 2.2 \times 10^4 \text{ M}^{-1}$ ).

### Cytotoxic Activity

The positive results obtained from DNA binding study encouraged us to test the cytotoxicity of the complexes against the human breast cancer cell line (MCF-7) and colon cancer cell line (HT-26) by MTT assay and cell viability studies (Fig. 3a and 3b). MTT assay protocol was used to assess the cytotoxicity of L1, L-Co, L1-Cu, and cis-platin in a variety of cell lines (MCF-7 and HT-26) in triplicates. Cells were successfully maintained with lead compound and cisplatin as a positive control, with concentrations steadily increasing from 5  $\mu\text{M}$  to 100  $\mu\text{M}$  over 24 h. The complex L1-Cu, with an  $\text{IC}_{50}$  value (20.35  $\mu\text{M}$ ) has exhibited a higher cytotoxicity profile than compound L1-Co against selected cancer cell lines tested. The  $\text{IC}_{50}$  values are given in Table 2. The L1-Cu complex possesses better cytotoxic activity than the L1-Co complex. The results of MTT assays indicate a significant cytotoxic activity against the two cell lines probably through a chelation effect.[31] The anticancer activities of the L1-Co and L1-Cu complexes against these cell lines may be attributed to their partial planar structure that avoids steric hindrance during physiological actions [35]. Also, the  $\text{IC}_{50}$  values were compared with those of similar L1-Co and L1-Cu complexes. The complex L1-Cu possesses better cytotoxic activity than L1-Co.

### DFT Calculations

Computational studies of synthesized ligands L1 and its complexes such as L1-Co and L1-Cu were carried out by using the combined DFT-B3LYP method using Gaussian 09 computational codes. Different quantum-chemical parameters were calculated by applying B3LYP/6-31G\*\*/LanL2DZ ECP methods such as molecular energy, ESP charges, the energy of frontier molecular orbitals, and bandgap, etc., Further, the highly preorganized planar geometries of ligands were shown in Fig. 5a. Whereas the 1:1 ligand to metal stoichiometry distracted tetrahedral geometry of Co and Cu complex was shown in Fig. 5b. The ligand forms a distracted tetrahedral geometry with Co and Cu metal centers along with the triphenylphosphine as co-ligand the corresponding key bond lengths were shown in Table 3. The electrostatic potential mapped onto the constant electron density surface for the optimized geometry on the Van der Waals surface. It is also very useful in research of molecular structure with its photophysical property relationship as well as hydrogen bonding interactions in free ligands and its Co and Cu complexes [32]. The maximum negative region which is the preferred site for electrophilic attack indicated as red color, and the maximum positive region which preferred site for nucleophilic attack symptoms is blue color. The frontier molecular orbitals comparing the highest occupied molecular orbital (HOMO), and the lowest molecular orbital (LUMO) with the energy gap between HOMO and LUMO of all the free ligand L1 and their L1-Co and L1-Cu complexes were calculated and displayed in Fig. 6. The free ligand exhibits the band gap energy of 4.09 eV, whereas upon the complex with Co and Cu the band gap reduced range from 2.67 to 2.64 eV. Furthermore, the energy gap ( $\Delta E$ ) is an important parameter to characterize the chemical reactivity and kinetic stability of the molecule [33]. The energy gap is small which indicates that charge transfer easily occurs in it. Which influences the biological activity of the molecule. The energies of frontier molecular orbitals ( $E_{\text{HOMO}}$  and  $E_{\text{LUMO}}$ ), energy band gap ( $\Delta E$ ) which explains the eventual charge transfer interaction within the molecule, electronegativity ( $\chi$ ), chemical potential ( $\mu$ ), global hardness ( $\eta$ ), global softness ( $s$ ) and global electrophilicity index ( $\omega$ ) [34,35] are listed in Table. 4. The importance of these parameters is to measure molecular stability and reactivity. The electrophilicity index is one of the most important quantum chemical parameters in describing the toxicity of various pollutants in terms of their reactivity and site selectivity [36]. Also, the electrophilicity property quantifies the biological activity of drug-receptor interaction.





Sathya et al.,

### Molecular Docking

The molecular docking technique can contribute to rational drug design and mechanistic studies by placing a small molecule into the binding site of the DNA target-specific region mainly in a non-covalent mode [37]. To explore the most feasible binding site, interaction mode, and binding affinity docking studies have been performed on complexes L1, L1-Co, and L2-Cu with B-DNA (PDB ID: 1BNA). As shown in Fig. 7, the complexes interact with DNA through partial intercalation at the major intercalation binding. The resulting relative binding energies of docked L1, L1-Co, and L1-Cu with DNA are -5.15, -7.35, and -6.12 kJ mol<sup>-1</sup>, respectively. The more negative binding energy shows a more potent DNA-binding affinity. Thus, the DNA-binding affinities follow the order of L1-Co > L1-Cu > L1. This is completely consistent with the results obtained from the electronic absorption titration. In addition, the results indicate that there is certain hydrogen-bonding interaction between the complexes and DNA. The length of these hydrogen bonds is 1.968 Å / DA-5 for L1, 1.951 Å DA7 for L1-Co, and 2.102 Å / DA-6 for L1-Cu, respectively.

### Pharmacokinetic Properties

In addition to binding free energy and intermolecular interactions, drug similarity and ADME features help determine a molecule's therapeutic value. ADME characteristics, Lipinski Rule of five (RO5), bioavailability radar, boiled egg procedures, etc. are used to determine drug similarity. These approaches are not equal to their experimental equivalents, but they are accurate enough to predict features of interest semi-quantitatively. All bioavailability measures are within allowed limits except the molecular saturation radar plot (Fig. 8a). Fig. 8b shows L1, L1-Co, and L1-Cu complex BOILED-EGG plot.[38] The drug-like properties were estimated by using both Lipinski's Rule of 5 and Veber's parameters suggesting that all the experimentally developed compounds complied well with the parameters. It is observed from Table 5, that compound both L1-Co and L1-Cu complexes lack BBB permeation with high GI absorption. Whereas the ligand L1 can readily cross BBB. They are well absorbed by the GI system as well. The rules for drug-likeness were violated by both the complex, but the extent of violation was not as high as the standard drug doxorubicin.

## CONCLUSION

A series of four-coordinated Co(II) and Cu(II) complexes containing monobasic bidentate Schiff base ligands have been synthesized and characterized. A square planar geometry has been proposed for the complexes based on spectroscopic studies. The preliminary DNA interaction study reveals that the ligand L1 and its complexes L1-Co and L1-Cu bind to DNA through partial intercalation binding. The binding affinity of [L1-Co] is found to be greater than that of L1 and [L1-Cu]. The complexes [L1-Co] and [L1-Cu] displayed significant cytotoxic activity against MCF-7 and HT-29 cancer cell lines. The complex L1-Cu, with an IC<sub>50</sub> value (20.35 μM) has exhibited a higher cytotoxicity profile than compound L1-Co against selected cancer cell lines tested. The experimental results were supported by *in-silico* computational studies such as DFT calculations, molecular docking, and ADME profile analysis.

## ACKNOWLEDGMENTS

The authors gratefully acknowledge the authorities of Chikkanna Government Arts College, Tirupur for providing technical support. The authors are pleased to thank Dr. G. Raja for his help in the characterization of compounds. The authors would like to acknowledge the instrumental facilities provided by the Department of Chemistry, Sri Ramakrishna Mission Vidyalaya College of Arts and Science, Coimbatore. The authors are grateful to Dr. G. Ayyannan, Department of Chemistry, Sri Ramakrishna Mission Vidyalaya College of Arts and Science, Coimbatore, for his help and support in carrying out DNA binding studies.

### Conflict of Interest

The authors declare no conflict of interest.





Sathya et al.,

**Declaration of competing interest**

The authors declare that they have no known competing financial interests or personal relationships that could have appeared to influence the work reported in this paper.

**REFERENCES**

1. S. Sathiyaraj, K. Sampath, R. J. Butcher, R. Pallepogu, and C. Jayabalakrishnan, *European Journal of Medicinal Chemistry* 64, 81 (2013).
2. K. Sampath, S. Sathiyaraj, and C. Jayabalakrishnan, *Spectrochimica Acta Part A: Molecular and Biomolecular Spectroscopy* 105, 582 (2013).
3. T. Stringer, B. Therrien, D. T. Hendricks, H. Guzgay, and G. S. Smith, *Inorganic Chemistry Communications* 14, 956 (2011).
4. Y. Li, Z.-Y. Yang, and M.-F. Wang, *European Journal of Medicinal Chemistry* 44, 4585 (2009).
5. R. M. Amin, N. S. Abdel-Kader, and A. L. El-Ansary, *Spectrochimica Acta Part A: Molecular and Biomolecular Spectroscopy* 95, 517 (2012).
6. Chavan and N. Pai, *Molecules* 12, 2467 (2007).
7. W.-J. Song, J.-P. Cheng, D.-H. Jiang, L. Guo, M.-F. Cai, H.-B. Yang, and Q.-Y. Lin, *Spectrochimica Acta Part A: Molecular and Biomolecular Spectroscopy*, 121, 70 (2014).
8. N. Sathya, P. Muthusamy, N. Padmapriya, G. Raja, K. Deivasigamani, and C. Jayabalakrishnan, *Journal of Coordination Chemistry* 62, 3532 (2009).
9. G. Selvi, F. A. Ozdemir, G. Aykutoglu, N. Özdemir, Z. Şerbetçi, M. Dinçer, and O. Dayan, *Inorganic and Nano-Metal Chemistry* 1 (2020).
10. B.R. Thorat, V. Pawar, M. Mustapha, R.S. Yamgar, R.G. Atram, *Asian Journal of Research in Chemistry*. 5, 1000 (2012).
11. D. Chatterjee, A. Mitra, and B. C. Roy, *Journal of Molecular Catalysis A: Chemical* 161, 17 (2000).
12. E. Franco, E. López-Torres, M. Mendiola, and M. Sevilla, *Polyhedron* 19, 441 (2000).
13. S. De, S. R. Chaudhuri, A. Panda, G. R. Jadhav, R. S. Kumar, P. Manohar, N. Ramesh, A. Mondal, A. Moorthy, S. Banerjee, P. Paira, and S. K. A. Kumar, *New J. Chem.* 43, 3291 (2019).
14. M. J. Frisch, G. W. Trucks, H. B. Schlegel, et al., *Gaussian 09, Revision D. 01*, Gaussian 09, Revision D. 01, Inc., Wallingford CT. (2009).
15. S. Saravana Kumar, R. Selva Kumar, and S. K. Ashok Kumar, *Inorganica Chimica Acta* 502, 119348 (2020).
16. L. V Skripnikov, *Chemissian Visualization Computer Program*, 4, 23 (2014).
17. S. Tabassum, W. M. Al-Asbahy, Mohd. Afzal, F. Arjmand, and V. Bagchi, *Dalton Trans.* 41, 4955 (2012)..
18. Mohd. A. Rauf, S. Zubair, and A. Azhar, *IJBAS* 4, 168 (2015).
19. Daina, O. Michielin, and V. Zoete, *Sci Rep* 7, 42717 (2017).
20. Majumder, G. M. Rosair, A. Mallick, N. Chattopadhyay, and S. Mitra, *Polyhedron* 25, 1753 (2006).
21. R. Karvembu, R. Prabhakaran, and K. Natarajan, *Coordination Chemistry Reviews* 249, 911 (2005).
22. K. Serbest, H. Kayi, M. Er, K. Sancak, and I. Değirmencioglu, *Heteroatom Chem.* 19, 700 (2008).
23. A.A. Osowole, *C. Festus Elixir International Journal* , 59, 15843 (2013).
24. N. Sathya, G. Raja, N. Padma Priya, and C. Jayabalakrishnan, *Appl. Organometal. Chem.* n/a (2010).
25. M. Neelakantan, M. Esakkiammal, S. Mariappan, J. Dharmaraja, and T. Jeyakumar, *Indian Journal of Pharmaceutical Sciences* 72, 216 (2010).
27. G.M. Sheldrick, *SHELXS-97*, University of Göttingen, Göttingen, Germany, 1997; b) GM Sheldrick, *Acta Crystallogr. Sect. A*. 46, 467 (1990).
28. S. Sukkur Saleem, M. Sankarganesh, P. Adwin Jose, and J. Dhaveethu Raja, *Inorganic Chemistry Communications* 124, 108396 (2021).
29. R. S. Kumar, S. Arunachalam, V. S. Periasamy, C. P. Preethy, A. Riyasdeen, and M. A. Akbarsha, *European Journal of Medicinal Chemistry* 43, 2082 (2008).





## Sathya et al.,

30. Z.-C. Liu, B.-D. Wang, Z.-Y. Yang, Y. Li, D.-D. Qin, and T.-R. Li, European Journal of Medicinal Chemistry 44, 4477 (2009).
31. Z.-C. Liu, B.-D. Wang, B. Li, Q. Wang, Z.-Y. Yang, T.-R. Li, and Y. Li, European Journal of Medicinal Chemistry 45, 5353 (2010).
32. S. De, S. K. Subran, S. K. Ramasamy, S. Banerjee, P. Paira, and A. K. S. Kalleshappa, ChemistrySelect 3, 5421 (2018).
33. E. Scrocco and J. Tomasi, in Advances in Quantum Chemistry 115 (1978).
34. M. Govindarajan, S. Periandy, and K. Carthigayen, Spectrochimica Acta Part A: Molecular and Biomolecular Spectroscopy 97, 411 (2012).
35. J. Padmanabhan, R. Parthasarathi, V. Subramanian, and P. K. Chattaraj, J. Phys. Chem. A 111, 1358 (2007).
36. R. G. Pearson, J. Org. Chem. 54, 1423 (1989).
37. R. Parthasarathi, J. Padmanabhan, V. Subramanian, U. Sarkar, B. Maiti, P. Chattaraj, Internet Electronic Journal of Molecular Design. 2, 798 (2003).
38. R. Rohs, I. Bloch, H. Sklenar, Z. Shakked, Nucleic Acids Research. 33, 7048 (2005).
39. Daina, V. Zoete, ChemMedChem. 11, 1117 (2016).

Table 1. FT-IR, Elemental analysis, and electronic data of ligand L1 and its Co and Cu complexes.

Compound	FT-IR (cm <sup>-1</sup> )				Elemental Analysis (%)			UV-Vis Abs. (nm)
	V(C=N)	V(Ph-OH)	V(Ph-C-O)	U(M=N)	C (%)	H (%)	N (%)	$\lambda_{max}$
L1	1637	3365	1342	-	61.20 (61.47)	5.53 (6.23)	15.37 (16.34)	226, 264, 300, 354
L1-Co	1579	-	1480	543	61.08 (58.34)	4.64 (6.44)	6.67 (6.36)	226, 260, 280, 360
L1-Cu	1576	-	1437	530	57.40 (58.20)	4.61 (5.21)	6.62 (7.23)	225, 261, 277, 295

Table 2. Comparison of IC50 values of complex with MCF-7 and HT-29 cell line

Complexes	IC <sub>50</sub> (μM)	
	MCF-7	HT-29
L1-Co	88.59 ±1.42	130.12 ±1.69
L1-Cu	20.35 ±1.87	83.78 ±1.53

Table 3. Selected bond angle and bond length for complexes

S. No	Bond Length (Å)	L1-Co	L1-Cu
1	M---Cl	2.2307	2.2632
	M---P	2.3356	2.4005
	M---N	1.9443	1.9698
	M---O	1.8608	1.9538
	<b>Angle (°)</b>		
2	N---M---O	91.3877	90.986
	N---M---P	109.3818	113.2659
	O---M---P	90.8403	94.1656
	N---M---Cl	116.8395	116.2271
	P---M---Cl	123.5388	118.4844
	O---M---Cl	117.5567	118.575





Sathya et al.,

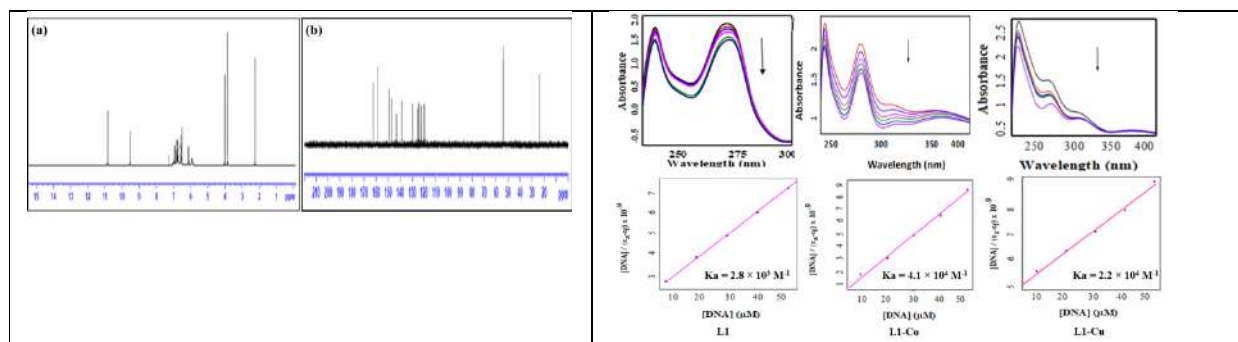
**Table 4:** Calculated molecular electronic parameters.

S.No	Code	Energy (Kcal/mol)	DM (Debay)	HOMO (eV)	LUMO (eV)	Gap (eV)	$\chi$ (eV)	$\mu$ (eV)	$\eta$ (eV)	S (eV)	$\omega$ (eV)
1	L1	-587442.03	2.70	-6.02	-1.93	-4.09	3.97	-3.97	-2.05	-1.02	-16.13
2	L1-Co	-1621571.71	6.59	-5.46	-2.79	-2.67	4.13	-4.13	-1.33	-0.67	-11.36
3	L1-Cu	-1653410.65	7.60	-5.09	-2.45	-2.64	3.77	-3.77	-1.32	-0.66	-9.41

\*Dipole moment (DM), Energy of HOMO (EH), energy of LUMO (EL), energy band gap ( $\Delta E$ ), electronegativity ( $\chi$ ), global hardness ( $\eta$ ), chemical potential ( $\mu$ ), global electrophilicity index ( $\omega$ ) and global softness (S).

**Table 5.** In silico prediction of physicochemical properties, toxicology, pharmacokinetics, drug-likeness of L1, L1-Co, and L1-Cu.

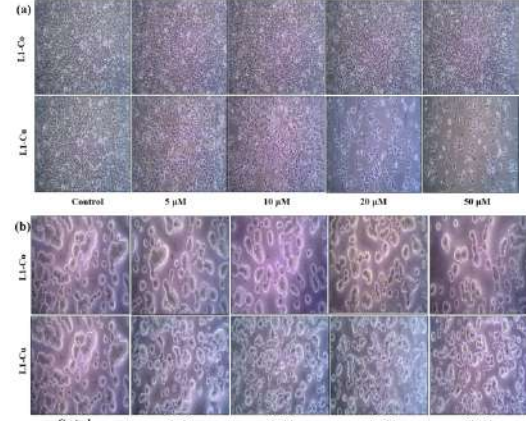
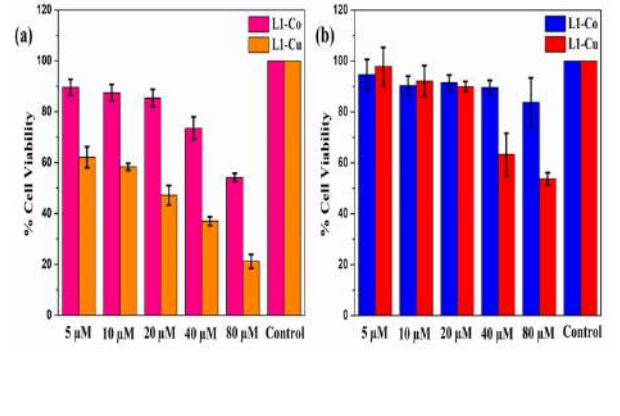
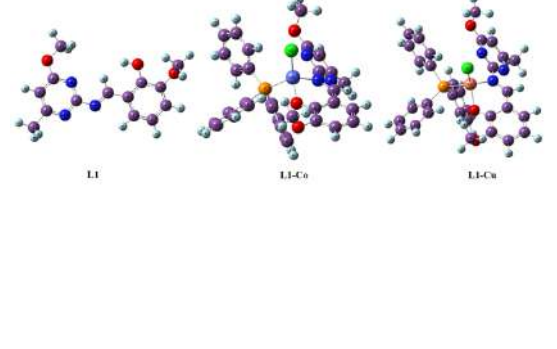
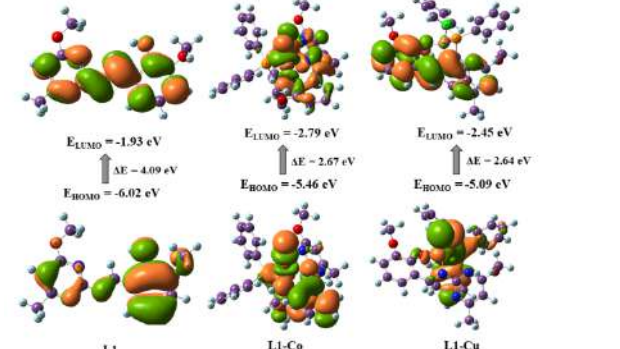
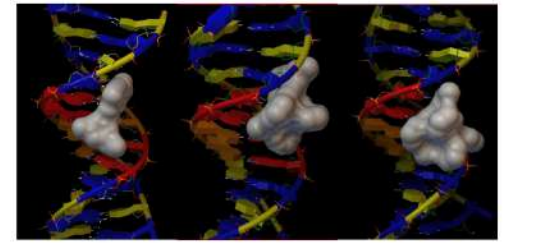
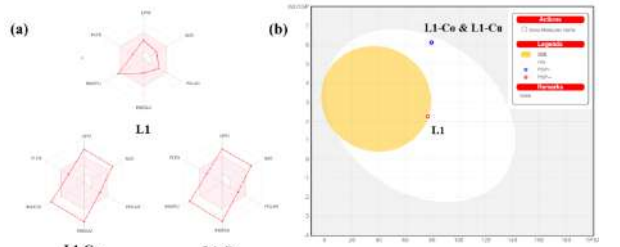
Properties/Ligand	L1	L1-Co	L-Cu	Doxorubicin
<b>Toxicology</b>				
Toxic	No	Yes	No	No
Molecular Weight (gm/mol)	273.29	628.95	633.56	543.52
TPSA (A <sup>2</sup> )	76.83	79.42	79.42	206.07
Hydrogen Donor	1	0	0	6
Hydrogen acceptor	6	5	5	12
Consensus: Log P	2.66	3.88	3.89	1.17
<b>Pharmacokinetics</b>				
GI absorption	High	High	High	Low
BBB permeant	Yes	No	No	No
Log Kp (skin permeation)	-6.43 cm/s	-4.69 cm/s	-4.72 cm/s	-8.71 cm/s
P-gp substrate	No	Yes	Yes	Yes
CYP1A2 inhibitor	Yes	No	No	No
<b>Drug-likeness</b>				
Lipinski	Yes	No; 2 violations: MW>500, MLOGP>4.15	No; 2 violations: MW>500, MLOGP>4.15	No; 3 violations: MW>500, N or O>10,
Ghose	Yes	No	No	No
Veber	Yes	Yes	Yes	No
Bioavailability Score	0.55	0.17	0.17	0.17



**Fig. 1.** (a) <sup>1</sup>H NMR (b) <sup>13</sup>C NMR Spectra for ligand L1 **Fig. 2.** Absorption spectral changes of (a) L1 (c) L1-Co and





<p>in DMSO-<i>d</i><sub>6</sub></p>	<p>(g) L1-Cu upon the addition of DNA in 5 mM Tris-HCl-NaCl buffer. The inset shows the plots of <math>[DNA]/(\epsilon_a - \epsilon_t)</math> versus <math>[DNA]</math> for the titration of the prepared compounds with CT-DNA.</p>
	
<p>Fig. 3. Cell image of (a) MCF-7 and (b) HT-29 Cell control in L1-Co and L1-Cu complexes</p>	<p>Fig. 4. Cell viability of synthesized complex L1-Co and L1-Cu with (a) MCF-7 and (b) HF-20 cell line.</p>
	
<p>Fig. 5. Optimized molecular geometry of free ligand L1 and its Co and Cu metal complexes by using the DFT/B3LYP method.</p>	<p>Fig. 6. FMOs of free L1, L1-Co and L1-Cu complexes by using DFT/B3LYP method</p>
	
<p>Fig. 7. Molecular docked models of complexes L1 (a), L1-Co (b), and L1-Cu (c) with DNA (PDB 1D:1BNA).</p>	<p>Fig. 8. (a) Bioavailability radar and (b) boiled egg plot of L1, L1-Co and L1-Cu complex.</p>





## Evaluation of Artificial Intelligence in the Structural Engineering Domain

Syed Aqeel Ahmad<sup>1</sup>, Tabish Izhar<sup>2\*</sup>, Tasneem Ahmed<sup>3</sup> and Neha Mumtaz<sup>4</sup>

<sup>1</sup>Professor, Department of Civil Engineering, Integral University, Lucknow, Uttar Pradesh, India.

<sup>2</sup>Assistant Professor, Department of Civil Engineering, Integral University, Lucknow, Uttar Pradesh, India.

<sup>3</sup>Associate Professor, Department of Computer Application, Integral University, Lucknow, Uttar Pradesh, India.

<sup>4</sup>Associate Professor, Department of Civil Engineering, Integral University, Lucknow, Uttar Pradesh, India.

Received: 22 Jan 2024

Revised: 09 Feb 2024

Accepted: 27 Apr 2024

### \*Address for Correspondence

**Tabish Izhar**

Assistant Professor,  
Department of Civil Engineering,  
Integral University,  
Lucknow, Uttar Pradesh, India.  
Email: tizhar@iul.ac.in



This is an Open Access Journal / article distributed under the terms of the **Creative Commons Attribution License** (CC BY-NC-ND 3.0) which permits unrestricted use, distribution, and reproduction in any medium, provided the original work is properly cited. All rights reserved.

### ABSTRACT

This study meticulously examines the application of artificial intelligence (AI) in structural engineering, employing a robust research methodology. The exploration begins by elucidating fundamental advancements in AI and its subfields, contributing to a comprehensive understanding of AI's role in structural engineering. A systematic search of the Scopus database spanning 1977 to 2024 yields 1970 pertinent documents, including research articles, conference papers, and patents, showcasing the diverse spectrum of AI techniques in the field. The collected data undergoes meticulous bibliometric analysis via VosViewer software, allowing for the visualization of trends, collaborations, and knowledge dissemination networks. Utilizing RIS files and adhering to a co-occurrence factor, this analysis results in an overlay visualization, comprising 926 keywords meeting the set threshold. Accurate citation of references is ensured through the use of the Mendeley reference manager. This methodologically rigorous review offers nuanced insights into the current landscape and future potential of AI integration in structural engineering.

**Keywords:** Artificial Intelligence, Structural Engineering, Bibliometric Analysis, Computational Modelling, Knowledge Dissemination Networks



Syed Aqeel Ahmad *et al.*,

## INTRODUCTION

Artificial Intelligence (AI) has arisen as a revolutionary technology with wide-ranging applications, including its impact on structural engineering (Luo & Paal, 2022). In the domain of civil engineering, the critical functions of structural analysis, design, and optimization are pivotal in ensuring the safety and efficiency of constructed infrastructure. Traditionally, these tasks have relied on manual calculations and simulation methods, which are time-consuming and may not fully explore the design space for optimal solutions (Keshtegar et al., 2019). The introduction of AI techniques into structural engineering holds the potential to revolutionize these processes by harnessing computational power and employing data-driven approaches. Structural engineering encompasses the analysis, design, and construction of buildings, bridges, dams, and other infrastructure, aiming to ensure their safety, stability, and durability (Lin et al., 2023). The incorporation of AI in structural engineering enables the automation of intricate tasks, facilitates data-driven decision-making, and improves performance predictions. Machine learning algorithms (Esfandiari et al., 2023), neural networks (Lazaridis et al., 2021), expert systems, and genetic algorithms (Lee & Ahn, 2003) are among the AI techniques currently under exploration to address various engineering challenges more efficiently. In the field of structural engineering, the importance of AI is underscored by its ability to effectively address key challenges faced by engineers and researchers:

### Enhanced Precision

AI models, with the capability to process extensive datasets and identify intricate patterns, contribute to the development of structures that are not only safer but also more resilient (Zeng et al., 2022).

### Optimization of Design

AI optimization algorithms explore diverse design parameters and constraints, identifying optimal solutions that lead to structures with improved performance and minimized material waste.

### Increased Efficiency

The implementation of AI-driven automation streamlines design and analysis processes, significantly reducing the time needed for generating structural solutions. This heightened efficiency allows engineers to focus on more intricate tasks and explore innovative designs.

### Promotion of Sustainable Practices

AI facilitates the incorporation of advanced materials, energy-efficient designs, and sustainable construction practices, endorsing environmentally friendly approaches in the field of structural engineering.

### Real-time Structural Health Monitoring

AI-enabled sensor networks continuously monitor structural health, detecting and predicting potential issues. This functionality allows for timely maintenance and the prevention of catastrophic failures.

### Enhanced Cost-Efficiency

Through the optimization of designs and the prediction of maintenance requirements, AI plays a crucial role in reducing construction and maintenance costs throughout the life cycle of structures.

## RESEARCH IMPLICATION

Evaluating the integration of artificial intelligence (AI) in the field of structural engineering carries immense research significance, presenting opportunities to revolutionize various aspects of the industry (Sayed et al., 2023). This comprehensive assessment spans the entire structural engineering process, encompassing design, analysis, construction, and maintenance. The research significance is underscored through the following focal points:







Syed Aqeel Ahmad *et al.*,

#### **Optimizing Design Efficiency**

AI facilitates the rapid generation of optimized design solutions, fostering more resource-efficient structures with reduced waste and potential cost savings.

#### **Implementing Advanced Analysis Techniques**

AI streamlines complex analysis techniques, once cumbersome or computationally intensive. Machine learning algorithms predict structural behaviour, enhancing understanding and risk mitigation.

#### **Early Identification of Flaws and Vulnerabilities**

AI-powered algorithms detect potential flaws or vulnerabilities in structural designs early in the process, enhancing safety, reliability, and preventing costly errors during construction or use.

#### **Continuous Structural Health Monitoring**

AI-based systems provide real-time structural health monitoring, enabling early detection of degradation or damage, leading to more effective maintenance strategies and increased safety.

#### **Automation and Robotics in Construction**

AI-driven robotics automate construction tasks, improving precision and reducing human errors. Research explores the streamlined building process with AI-guided construction machinery.

#### **Sustainability and Environmental Impact**

The assessment considers AI's potential to create sustainable structures through optimizing energy efficiency, material usage, and overall environmental impact.

#### **Risk Assessment and Mitigation**

AI analyzes historical and real-time data to assess risks in design decisions, construction methodologies, and environmental factors, contributing to enhanced risk management.

#### **Interdisciplinary Collaboration**

Research encourages collaboration among computer scientists, data scientists, and engineers, fostering innovative solutions that leverage AI capabilities.

#### **Data-driven decision-making**

Effective collection, management, and analysis of massive data generated during a structure's lifecycle are essential for informed decision-making, and improving project outcomes.

#### **Establishing Regulatory and Safety Standards**

The integration of AI in structural engineering necessitates the development of new standards and regulations, with research contributing to guidelines ensuring AI-powered solutions meet safety and regulatory requirements.

#### **Training and Skill Development**

As AI becomes prevalent, research focuses on developing training programs and resources to bridge the gap between traditional engineering practices and AI-based approaches.

In conclusion, the research underscores the vital importance of assessing AI's application in structural engineering, offering potential enhancements in efficiency, safety, sustainability, and innovation within the industry. This research area holds promise for transformative advancements, reshaping the approach to designing, constructing, and maintaining structures.



Syed Aqeel Ahmad *et al.*,

## METHODOLOGY

The research methodology outlined in this review begins by elucidating the fundamental advancements in artificial intelligence (AI) and its subfields, detailing their contributions to the application of AI in structural engineering. A systematic search of the Scopus database from 1977 to 2024 was conducted to collect a comprehensive array of research articles, conference papers, and patents that represent the diverse spectrum of AI techniques used in the field. The Scopus online repository was explored extensively in both AI and structural engineering, utilizing specific keywords (TITLE-ABS-KEY (artificial AND intelligence) AND TITLE-ABS-KEY (structural AND engineering)). This meticulous process yielded a total of 1970 relevant documents. Following this, the collected data underwent bibliometric analysis using VosViewer software. This analysis enabled the visualization of trends, collaborations, and knowledge dissemination networks. The bibliometric analysis involved the use of RIS files downloaded from the Scopus database and was conducted using VosViewer version 1.6.16. The overlay visualization was obtained by including 15459 keywords by setting the minimum 5 co-occurrence factor, 926 keywords met the threshold and the results are depicted in Figure 1. The Mendeley reference manager was used for accurate citation of references. The research delved into various facets of AI applications in civil engineering, elaborating on different AI methods. It presented a comprehensive description of the AI system, including the future scope of this technology in the field. The research methodology employed initial data collection followed by thorough analysis to extract meaningful insights. The analysis uncovered the evolutionary trajectory of AI utilization over time, identifying key periods of accelerated research output. Notably, it identified research clusters within the field, categorizing AI applications into areas such as structural optimization, predictive maintenance, risk assessment, and performance prediction.

The examination of co-authorship networks and institutional collaborations revealed pivotal research hubs and their collaborative networks, providing insights into the global landscape of AI research in structural engineering. Additionally, the review explored the impact of AI adoption on structural engineering practice, elucidating both the benefits and challenges faced by the industry. The integration of AI has accelerated the design process, improved accuracy in load prediction, and facilitated real-time monitoring of structural health. However, concerns related to data security, the interpretability of AI-driven results, and the ongoing need for human expertise persist as significant challenges. The data utilized in this study is secondary, sourced from various articles, journals, and other relevant resources containing essential information related to the research topic. The collection process involved accessing databases from different academic sources, with data retrieval guided by specific keywords related to the research topic (Akkar *et al.*, 2014; Huang & Burton, 2020). The initial step included accessing the database, followed by conducting searches using keywords to obtain relevant articles. Subsequently, data deemed necessary for the research was extracted from the obtained search results, adhering to predefined criteria set for the selection of pertinent information. Figure 2 illustrates documents by year the country-wise distribution of publications and the types of documents about artificial intelligence (AI) in structural engineering. The information containing keywords such as "machine learning," "deep learning," and others was collected for analysis. Following this, both quantitative and qualitative analyses were conducted. It's worth noting the presence of two types of machine intelligence, namely "soft computing" and "hard computing." The "hard computing" approach involves the utilization of binary logic, and it incorporates "numerical analysis" and "analytical model" techniques (Rousakis *et al.*, 2007; Sayed *et al.*, 2023).

### Applications of Artificial Intelligence in Structural Engineering

AI techniques have found application in diverse aspects of structural engineering, employing various methods to enhance processes related to analysis, design, and optimization (Akkar *et al.*, 2014). As previously mentioned, emerging AI techniques such as machine learning, pattern recognition, and deep learning are becoming increasingly reliable tools in the structural engineering domain. This section provides a technical overview of these techniques and outlines their application to address structural engineering challenges. Machine learning algorithms, including support vector machines, random forests, and neural networks, are employed in structural analysis to predict structural behaviour and efficiently analyze complex systems. These algorithms have seen growing use in enhancing modelling, prediction, and optimization capabilities within structural engineering (Rousakis *et al.*, 2007; Sayed *et al.*,





Syed Aqeel Ahmad *et al.*,

2023). Pattern recognition involves classifying objects into different categories based on data features, with "supervised" and "unsupervised" learning as the two main types. Supervised learning utilizes labelled training samples, while unsupervised learning involves unlabelled training samples, distinguishing between generative and discriminative models (Ancheta et al., 2014). Deep learning, primarily used for unsupervised learning data understanding, incorporates multiple hidden layers. Networks like convolutional neural networks and recurrent neural networks are part of this model, with the former being particularly popular in structural engineering applications (Zhang et al., 2021). AI's primary application in structural engineering lies in monitoring structural health through machine learning. Regular assessment of structural conditions is crucial, with a focus on concrete properties to easily determine its quality and condition through machine learning techniques (Xie et al., 2020). Pattern recognition applications extend to damage detection within structures, earthquake engineering, seismic design, structural identification, and performance evaluation (Sun et al., 2020). Deep learning is instrumental in crack detection and identifying structural damages based on vibration analysis (Sun et al., 2021). Additionally, this method can determine the condition of structures. The review emphasizes the potential benefits of AI in enhancing efficiency, accuracy, and cost-effectiveness in structural design and analysis (Rashki et al., 2018), while acknowledging associated limitations and ethical considerations (Meshref et al., 2022). A comparative analysis of different AI approaches and methodologies used in structural engineering is mentioned in Table 1: The inclusion and exclusion criteria guide the applicability of each AI technique based on specific strengths and weaknesses, allowing practitioners to make informed choices for their structural engineering applications.

#### **Anticipated Trends and Future Pathways in the Intersection of Artificial Intelligence and Structural Engineering**

The horizon for Artificial Intelligence (AI) in structural engineering promises transformative developments, poised to reshape diverse dimensions of the industry. Several key areas are foreseen to experience substantial impact:

##### **AI-Enhanced Design Processes and Collaborative Workflows:**

- AI is projected to play a pivotal role in aiding structural engineers across the design spectrum, from initial concept creation to detailed design stages.
- AI-powered tools are expected to streamline the generation of innovative design solutions, expedite feasibility studies, and automate repetitive tasks, freeing up engineers to concentrate on critical project elements.

##### **Integration of AI into Building Information Modeling (BIM):**

- AI is set to elevate the capabilities of BIM platforms, enabling advanced analysis, optimization, and simulation within the BIM framework.
- This integration is anticipated to foster seamless collaboration among diverse stakeholders and enhance the overall efficiency of construction projects.

##### **Explainable AI for Regulatory Adherence and Approvals:**

- The increasing prevalence of AI systems in structural engineering necessitates the development of explainable AI models.
- These models are designed to ensure transparency, accountability, and alignment with regulatory standards, bridging the comprehension gap between intricate AI models and human decision-making.

##### **Continuous Learning and Adaptive Systems in Structural Engineering:**

- AI-powered systems are envisioned to exhibit continuous learning capabilities, leveraging new data, experiences, and feedback for ongoing improvement.
- Adaptive AI algorithms are expected to dynamically adjust strategies and solutions in response to evolving project requirements and changing conditions.

The unfolding narrative of AI in structural engineering foresees heightened integration of AI technologies, expanded utilization of AI in BIM processes, and a transition towards more transparent and adaptable AI





Syed Aqeel Ahmad *et al.*,

solutions. These advancements are poised to usher in substantial efficiencies, contributing to the development of structures that are not only safer but also more resilient and sustainable.

## CONCLUSION

In conclusion, the synergy between Artificial Intelligence (AI) and structural engineering presents a compelling narrative of innovation and progress. The discussed AI techniques, including Genetic Algorithms, Artificial Neural Networks, and Finite Element Analysis, each contribute unique strengths to the field. As we peer into the future, the prospects for AI in structural engineering are not only promising but transformative. The envisaged trends, such as AI-augmented design, BIM integration, and explainable AI, underscore a paradigm shift in how structures are conceived, designed, and constructed. The collaborative workflows facilitated by AI promise to unleash creativity among engineers while enhancing the efficiency of the entire design process. The integration of AI with BIM platforms is set to redefine collaboration, providing a holistic environment for optimized decision-making across diverse stakeholders. The imperative for explainable AI models echoes the industry's commitment to transparency, accountability, and adherence to regulatory standards. This ensures that AI becomes a trusted ally, augmenting human decision-making rather than replacing it. Moreover, the continuous learning capabilities and adaptive nature of AI-powered systems herald a dynamic era in structural engineering, where solutions evolve in harmony with changing project requirements and conditions. As the future unfolds, the anticipated advancements hold the potential to not only streamline processes but also enhance the safety, resilience, and sustainability of structures. The journey ahead beckons us to embrace these technological strides responsibly, considering ethical implications and striking a balance between innovation and reliability. In essence, the convergence of AI and structural engineering heralds an era where the fusion of human ingenuity and technological prowess creates structures that stand not just as marvels of engineering but as testaments to the harmonious collaboration between human expertise and artificial intelligence.

## ACKNOWLEDGEMENT

The authors have not received any funding. The authors thank Integral University, Lucknow for providing all necessary facilities for carrying out the research. MCN: IU/R&D/2024-MCN0002610.

## REFERENCES

1. Akkar, S., Sandikkaya, M. A., Şenyurt, M., Sisi, A. A., Ay, B., Traversa, P., Douglas, J., Cotton, F., Luzi, L., Hernandez, B., & Godey, S. (2014). Reference database for seismic ground-motion in Europe. *Bulletin of Earthquake Engineering*, 12(1), 311–339. <https://doi.org/10.1007/S10518-013-9506-8>
2. Ancheta, T. D., Darragh, R. B., Stewart, J. P., Seyhan, E., Silva, W. J., Chiou, B. S. J., Wooddell, K. E., Graves, R. W., Kottke, A. R., Boore, D. M., Kishida, T., & Donahue, J. L. (2014). NGA-West2 database. *Earthquake Spectra*, 30(3), 989–1005. <https://doi.org/10.1193/070913EQS197M>
3. Cioffi, R., Travaglioni, M., Piscitelli, G., Petrillo, A. and De Felice, F., (2020). Artificial intelligence and machine learning applications in smart production: Progress, trends, and directions. *Sustainability*, 12(2), p.492. <https://doi.org/10.3390/su12020492>
4. Esfandiari, M. J., Haghghi, H., & Urgessa, G. (2023). Machine learning-based optimum reinforced concrete design for progressive collapse. *Electronic Journal of Structural Engineering*, 23(2), 1–8. <https://doi.org/10.56748/EJSE.233642>
5. Huang, H., & Burton, H. V. (2020). A database of test results from steel and reinforced concrete infilled frame experiments. *Earthquake Spectra*, 36(3), 1525–1548. <https://doi.org/10.1177/8755293019899950>



Syed Aqeel Ahmad *et al.*,

6. Keshtegar, B., Bagheri, M., & Yaseen, Z. M. (2019). Shear strength of steel fiber-unconfined reinforced concrete beam simulation: Application of novel intelligent model. *Composite Structures*, 212, 230–242. <https://doi.org/10.1016/j.compstruct.2019.01.004>
7. Lazaridis, P. C., Kavvadias, I. E., Demertzis, K., Iliadis, L., Papaleonidas, A., Vasiliadis, L. K., & Elenas, A. (2021). Structural damage prediction under seismic sequence using neural networks. *COMPADYN Proceedings*, 2021-June. <https://www.scopus.com/inward/record.uri?eid=2-s2.0-85120807944&partnerID=40&md5=1a963c4ed866bb4ffdb0aa8d42b81213>
8. Lee, C., & Ahn, J. (2003). Flexural design of reinforced concrete frames by genetic algorithm. *Journal of Structural Engineering*, 129(6), 762–774. [https://doi.org/10.1061/\(ASCE\)0733-9445\(2003\)129:6\(762\)](https://doi.org/10.1061/(ASCE)0733-9445(2003)129:6(762))
9. Lin, K., Li, D., Xie, L., He, M., & Sun, Y. (2023). Analytical Model for Progressive Collapse of RC Frame Beam-Column Substructures Using Multi-Gene Genetic Programming. *International Journal of Structural Stability and Dynamics*. <https://doi.org/10.1142/S021945542350150X>
10. Luo, H., & Paal, S. G. (2022). Artificial intelligence-enhanced seismic response prediction of reinforced concrete frames. *Advanced Engineering Informatics*, 52. <https://doi.org/10.1016/j.aei.2022.101568>
11. Meshref, A., El-Dash, K., Basiouny, M., & El-Hadidi, O. (2022). Implementation of a Life Cycle Cost Deep Learning Prediction Model Based on Building Structure Alternatives for Industrial Buildings. *Buildings*, 12(5). <https://doi.org/10.3390/buildings12050502>
12. Rashki, M., Ghavidel, A., Ghohani Arab, H., & Mousavi, S. R. (2018). Low-cost finite element method-based reliability analysis using adjusted control variate technique. *Structural Safety*, 75, 133–142. <https://doi.org/10.1016/j.strusafe.2017.11.005>
13. Rousakis, T. C., Karabinis, A. I., & Kiouisis, P. D. (2007). FRP-confined concrete members: Axial compression experiments and plasticity modelling. *Engineering Structures*, 29(7), 1343–1353. <https://doi.org/10.1016/j.engstruct.2006.08.006>
14. Sayed, Y. A. K., Ibrahim, A. A., Tamrazyan, A. G., & Fahmy, M. F. M. (2023). Machine-learning-based models versus design-oriented models for predicting the axial compressive load of FRP-confined rectangular RC columns. *Engineering Structures*, 285. <https://doi.org/10.1016/j.engstruct.2023.116030>
15. Sun, H., Burton, H.V. and Huang, H., (2021). Machine learning applications for building structural design and performance assessment: State-of-the-art review. *Journal of Building Engineering*, 33, p.101816. <https://doi.org/10.1016/j.jobe.2020.101816>
16. Sun, L., Shang, Z., Xia, Y., Bhowmick, S., & Nagarajaiah, S. (2020). Review of Bridge Structural Health Monitoring Aided by Big Data and Artificial Intelligence: From Condition Assessment to Damage Detection. *Journal of Structural Engineering*, 146(5), 04020073. [https://doi.org/10.1061/\(ASCE\)ST.1943-541X.0002535](https://doi.org/10.1061/(ASCE)ST.1943-541X.0002535)
17. Xie, Y., EbadSichani, M., Padgett, J. E., & DesRoches, R. (2020). The promise of implementing machine learning in earthquake engineering: A state-of-the-art review. 36(4), 1769–1801. <https://doi.org/10.1177/8755293020919419>
18. Zeng, Z., Zhu, Z., Yao, W., Wang, Z., Wang, C., Wei, Y., Wei, Z., & Guan, X. (2022). Accurate prediction of concrete compressive strength based on explainable features using deep learning. *Construction and Building Materials*, 329. <https://doi.org/10.1016/j.conbuildmat.2022.127082>
19. Xie, Y., EbadSichani, M., Padgett, J.E. and DesRoches, R., (2020). The promise of implementing machine learning in earthquake engineering: A state-of-the-art review. *Earthquake Spectra*, 36(4), pp.1769-1801. <https://doi.org/10.1177/87552930209194>
20. Zhang, W., Li, H., Li, Y., Liu, H., Chen, Y. and Ding, X., (2021). Application of deep learning algorithms in geotechnical engineering: a short critical review. *Artificial Intelligence Review*, pp.1-41. <https://doi.org/10.1007/s10462-021-09967-1>





**Syed Aqeel Ahmad et al.,**

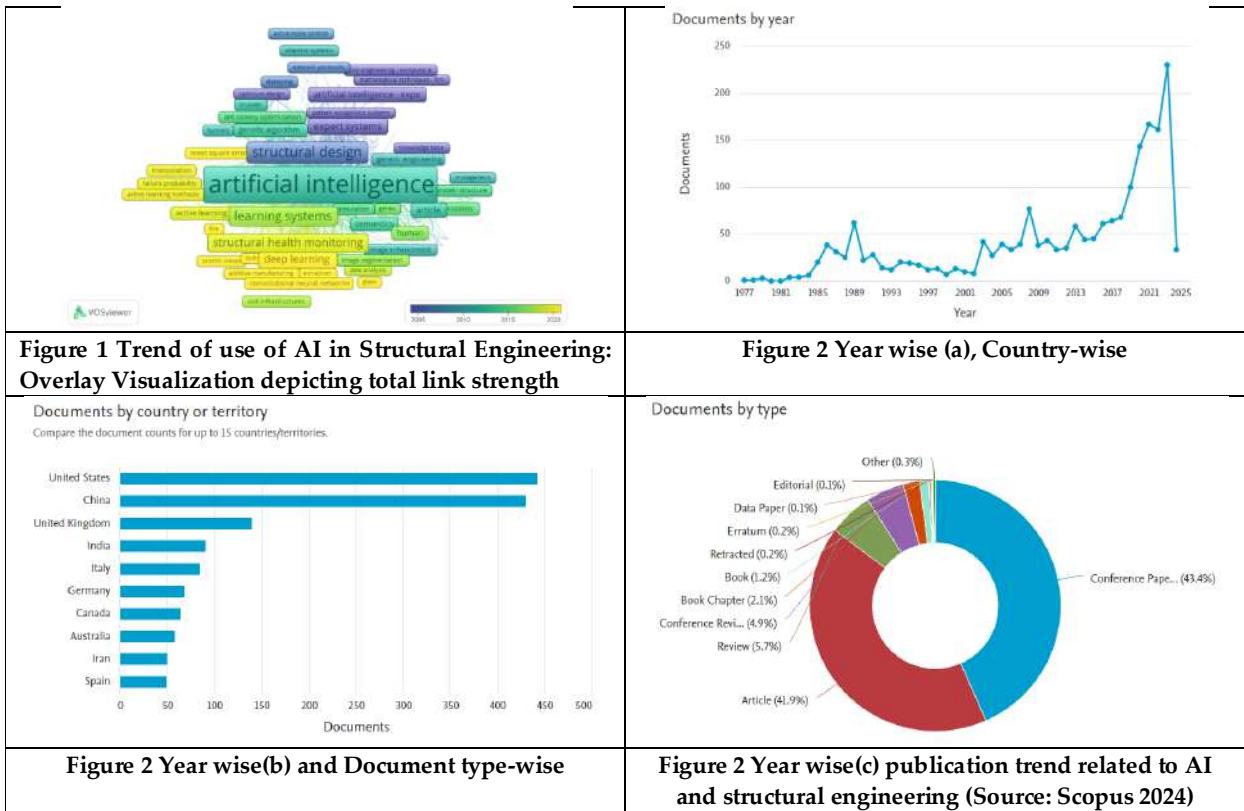
**Table 1: Comparative Analysis of AI Approaches and Methodologies in Structural Engineering**

AI Technique	Strengths	Weaknesses	Performance in Scenarios
<b>Genetic Algorithms (GA)</b>	- Optimization: Effective in solving complex optimization problems.	- Convergence: May converge to suboptimal solutions.	- Large, complex, nonlinear design spaces. - Cases with no clear analytical expression for the objective function.
	- Parallelism: Can be parallelized for faster convergence.	- Local Optima: Prone to getting stuck in local optima.	
	- Non-Differentiable Functions: Handles non-differentiable functions.	- Computational Intensity: Can be computationally intensive.	
<b>Artificial Neural Networks (ANN)</b>	- Pattern Recognition: Captures complex relationships in data.	- Black Box: Lack of interpretability.	- Predicting structural behaviors, such as deformation and stress distribution. - Dealing with complex and nonlinear relationships.
	- Nonlinear Modeling: Models nonlinear behavior effectively.	- Data Dependency: Performance relies on the quality and quantity of training data.	
	- Generalization: Generalizes patterns from training data.	- Overfitting: Prone to overfitting.	
<b>Finite Element Analysis (FEA)</b>	- Accuracy: Provides accurate numerical solutions for various behaviors.	- Computational Demand: Can be computationally expensive and time-consuming.	- Detailed structural analysis, stress distributions, and deformations. - Scenarios where accuracy and in-depth insights are crucial.
	- Versatility: Models a wide range of material behaviors.	- Mesh Sensitivity: Results can be sensitive to mesh quality.	
	- Detailed Insights: Provides detailed insights into local behaviors.	- Limited Optimization: Traditional FEA may not inherently include optimization.	





**Syed Aqeel Ahmad et al.,**





## Diazotrophs: An Essential Microflora to Sustain the Agriculture Land to Improve the Cereals Production

Amit Kumar<sup>1</sup>, Chahat Sharma<sup>1</sup>, Pooja Sharma<sup>2\*</sup>, Raj Singh<sup>3</sup>, Anita Rani Gill<sup>4</sup> and Soniya Goyal<sup>2</sup>

<sup>1</sup>Ph.D Student, Department of Biosciences and Technology, Maharishi Markandeshwar (Deemed to be University), Mullana, Haryana, India.

<sup>2</sup>Assistant Professor, Department of Biosciences and Technology, Maharishi Markandeshwar (Deemed to be University), Mullana, Haryana, India.

<sup>3</sup>Professor, Department of Biosciences and Technology, Maharishi Markandeshwar (Deemed to be University), Mullana, Haryana, India.

<sup>4</sup>Assistant Professor, Department of Biosciences and Technology, Guru Jambheshwar University of Science and Technology, Hisar, Haryana, India.

Received: 22 Jan 2024

Revised: 09 Feb 2024

Accepted: 29 Apr 2024

### \*Address for Correspondence

#### Pooja Sharma

Assistant Professor,

Department of Biosciences and Technology,

Maharishi Markandeshwar (Deemed to be University),

Mullana, Haryana, India.

Email: pooja0029@gmail.com



This is an Open Access Journal / article distributed under the terms of the **Creative Commons Attribution License** (CC BY-NC-ND 3.0) which permits unrestricted use, distribution, and reproduction in any medium, provided the original work is properly cited. All rights reserved.

### ABSTRACT

India is an agriculture-based country where more than 70% of rural population still depends on agriculture. India occupies only 2.4% of total world's land area. However, it is observed that 18% of world's population is fed by Indian agriculture. It is expected that India will reach a total population of 1.5 billion by 2030 and cross 1.6 billion population by 2050. In this situation 100 million tons and 140 million tons of wheat production would be required by 2030 and 2050 respectively. To enhance the crop production, we need more focus on fertility of soil or nutrient content of the soil which is directly responsible to sustain the fertility of soil. Various essential soil limiting factors gradually decreases due to continue usage of chemical fertilizers to enhance crop production. Ultimately these chemicals are so harmful and lead to soil acidification, water pollution, air pollution and many mysterious diseases that were not found earlier. This excessive use of synthetic fertilizers is not only harming the soil but also contribute in various diseases like diabetes mellitus, Alzheimer, hemoglobin disorder, cancer, kidney and liver disorder. In this article, we are discussing the important parameters of nitrogen fixing bacteria such as diazotrophs which are natural source of biological nitrogen fixation to maintain the soil fertility using atmospheric nitrogen.







Amit Kumar et al.,

**Keywords:** Diazotrophs, Nitrogen utilizing efficient, Temperature, Cereals, Nitrogen fixation.

## INTRODUCTION

Plant system needs nitrogen for their growth and development but they are unable to use it directly; they can access only biological form ( $\text{NH}_3$ ) of nitrogen [1]. It is an essential element utilized by plants and animals for their development. In our atmosphere 78% of nitrogen is found in dimerization ( $\text{N}_2$ ) form. Nitrogen fixation, decomposition, Haber process are the main processes by which nitrogen and its compounds are inter converted into environment and consumed by plants and living organisms. Prokaryotic bacteria are capable of fixing the nitrogen because of their special enzyme called nitrogenase [2, 3]. Nitrogenase is the enzyme which expressed under nitrogen limitation conditions. Normally, its expression is regulated via negative feedback from its own product in various microorganisms (*Rhodobactersphaeroides*, *Rhodopseudomonas palustris*, *Rhodobactercapsulatus*) [4]. Biological Nitrogen fixation is the major natural process through which atmospheric  $\text{N}_2$  is converted into biological form that can be used by plants (Fig.1). It is reported that nitrogen fixation contributing nearly 100–290 Tg N per year [5]. In addition to this, approximately 3–10 TgN per year could be fix with the help of natural lightning worldwide.

The energy produces from natural lightning converts oxygen and nitrogen into nitric oxide, which oxidized to nitrogen dioxide, then to nitric acid. Within few days the nitric acid is transferred to ground through rain, snow, hail or other atmospheric deposition and naturally utilized by plants [6] (Fig.1). Plant growth promoting bacteria (PGPR) can also improve nutrient uptake efficiency by producing phyto-hormones to the host, and convene resistance against pathogens [7]. Nitrogen fixing bacteria known as diazotrophs (cyanobacteria and rhizobium and alfalfa) play essential role in biological nitrogen fixation by solubilizing the chemical  $\text{N}_2$  into biological  $\text{NH}_3$  in rhizosphere (Fig. 1). It is known that these natural diazotrophs fixes 100–300 tg of nitrogen per year on earth [8]. In modern agriculture, to enhance the production of cereals a huge amount of synthetic nitrogen is used in agriculture field. Excessive use of synthetic nitrogen leads to adverse issues such as eutrophication of water, loss of biodiversity, global warming and stratospheric ozone depletion. About 60% of global synthetic nitrogen consumption is reported only in three major cereal crops such as rice, wheat, and maize [9]. This excessive use of nitrogen compounds in any form (water, air, and soil) wreaks havoc on the delicate rhizosphere and cause adverse effect on soil fertility [10, 11, 9, 12]. Furthermore, chemical nitrogen is highly soluble in water so it drains away with water flow and merges with rivers and ground water which cause harmful effects on human and animal health. An alternative sustainable solution for soils immediately incorporation of biological nitrogen fixation (BNF) that can reduces the undesired effects of chemical nitrogen.

### Effects of chemical fertilizers on soil, air and water

It was studied that the effects of chemical fertilizers on the soil are not immediately as soils have strong buffering power due to their diverse composition. Over the time, it causes pollution, deterioration of soil fertility, soil degradation and imbalance of the nutrients in soil [13]. Distribution of chemical fertilizer is depending open the population of different country and consumption of cereals. This excessive toxic accumulation within crops and vegetables causes negative effects in humans as well as in animals [14, 15, 16]. Furthermore, soil structure and its texture in agriculture field is a key indicator for high yield [17]. Unfortunately, soil structure gets deteriorate due to continuously huge usage of chemical nitrogen and industrial effluents, such as  $\text{NaNO}_3$ ,  $\text{NH}_4\text{NO}_3$ ,  $\text{NH}_4\text{Cl}$  and  $\text{CO}(\text{NH}_2)_2$ . Nitrogen is one of the most important inputs in fertilizer used in agriculture to enhance the crop production. Several nutrients and environmental factors can be controlled and directly proportional to the concentration of ammonia in the soil solution. However chemical nitrogen disrupts the balance of nutrients and makes a negative impact on soil pH, soil structure and increasing feature of acid irrigation on agricultural land [18]. This excessive use of chemical nitrogen fertilizer also affects the symbiotic bacterial species, such as symbiotic relationship between plants and microorganisms and hence chemical fertilizers limit the activities of nitrifying bacteria [18, 19]. Synthetic nitrogen also causes air pollution by nitrogen oxides ( $\text{NO}$ ,  $\text{N}_2\text{O}$ ,  $\text{NO}_2$ ) emissions [20]. In





Amit Kumar et al.,

our atmosphere, N<sub>2</sub>O increases gradually from 0.2 to 0.3% every year. This excessive use of nitrogenous content, especially nitrate content would be a major concern for atmosphere and human health [21]. Use of ammonium fertilizers with urea can result in evaporation of NH<sub>3</sub> especially on calcareous (calcium carbonate (CaCO<sub>3</sub>)) and alkaline soils. NH<sub>3</sub> may be oxidized and turn into nitric acid, sulfuric acid from industrial sources, creates acid rain after the chemical transformations. Acid rain can damage vegetation as well as in organisms that live in both lakes and reservoirs [19]. Besides these compounds some gases are also evolved such as carbon dioxide, methane, hydrogen sulfide (H<sub>2</sub>S) with chloro-fluoro hydrocarbons and halogen. Some gases persist at lower layer of tropospheric ozone and contribute in greenhouse effect. Synthetic nitrogen used in agriculture causes contamination in water source by three different ways: Drainage, leaching and flow. Nitrate leaching particularly linked to agricultural practices such as fertilizer, cultivation, irrigated agricultural land in some of the arid and semiarid regions, increased amounts of nitrate accumulation in the soil used and along with the evaporation of water [22, 23]. In soil, fertilizers converted to nitrate through nitrification by various microorganisms. Due to negative charge of nitrate it can reach to the ground water. In ideal conditions, plants use only 50% of nitrogenous fertilizer applied to the soil, other 2-20% lost via evaporation, 15-25% react organic compounds in the soil and 2-10% remains at interfere surface and ground water [24, 25, 26]. The majority of nitrogenous fertilizers are not absorbed by plants and they interfere with both underground and surface water. This is a major issue of concern as it causes pollution. In European Countries, NO<sub>3</sub> concentration value is 23 mg/L and in the USA it is nearly 45 mg/L [27]. In Nottingham (United Kingdom), nitrate and ammonium concentration in soil is gradually increasing [19].

#### Types of diazotrophs involved in the processing of nitrogen fixation

The word diazotroph is derived from the word diazo (N<sub>2</sub>) and troph (pertaining to food or nourishment). Diazotrophs are scattered across the bacterial taxonomic groups (as well as a couple of Archaea). Two of the most studied diazotrophs are *Klebsiella pneumoniae* and *Azotobacter vinelandii* were isolated by Dixon and Kahn are important bacteria in biological nitrogen fixation [28, 29, 30, 2, 31]. **Obligate** anaerobes are the bacteria which cannot grow in oxygen. They can survive either in absence of oxygen or in very low oxygen conditions, such as soils (natural wetlands, floodplains, swamps, peatlands) and decaying vegetable matter such as clostridium [32]. Sulphate-reducing bacteria are important microorganism in ocean sediments (*Desulfovibrio*), and some archaea such as methanogens, like methanococcus, which fix nitrogen in muds, animal intestines and anoxic soils [33]. **Facultative** anaerobes can grow in oxygen deficient as well as in oxygen sufficient conditions, but nitrogen fixing facultative bacteria survives only in anaerobic conditions such as *Klebsiella pneumoniae*, *Paenibacillus polymyxa*, *Bacillus maceans*, and *Escherichia* [34]. The *Klebsiella pneumoniae* has been reported to protect rice from sheath blight and seedling blight diseases [35]. Approximately 20 members of the *Paenibacillus* genus reported to have the capacity of biological nitrogen fixation [36]. Moreover aerobic bacteria require oxygen to grow, but their nitrogenase activity is decreases as the oxygen level increases. *Azotobacter vinelandii* is one of the example, which uses high respiration rate and more potent to prevent oxygen damage [37].

Many other species also reduce the oxygen levels in the same way, but with lower respiration rates and lower oxygen tolerance. Oxygenic photosynthetic bacteria (*Cyanobacteria*) generate oxygen as a by-product of photosynthesis, yet some are able to fix nitrogen as well. Some of the colonizing bacteria that have specialized cells (heterocysts) that lack the oxygen generating steps of photosynthesis such as *Anabaena cylindrica* and *Nostoc commune*. Beside these bacteria some of the cyanobacteria that lack heterocysts but could fix nitrogen under low light and low oxygen level (*Plectonema*) [38]. Some cyanobacteria, including marine taxa *Prochlorococcus* and *Synechococcus* do not fix nitrogen whereas other marine cyanobacteria, such as *Trichodesmium* and *Cyanothece*, are major contributors in oceanic nitrogen fixation [39]. **Rhizobium** is another genus of gram-negative bacteria that fix nitrogen in nodules of leguminous family. The legume-rhizobium symbiosis is an example of mutualism where rhizobia supply ammonia or amino acids to the plant and in return receive organic acids as a carbon and energy source. Inside the root nodule, bacteria differentiate morphologically into bacteroids and fix atmospheric nitrogen into ammonium, using nitrogenase enzyme. In return, the plant supplies carbohydrates as energy rich compounds in the form of organic acids to the bacteria [40]. Furthermore, plant also provides oxygen for cellular respiration to the bacteria which are tightly bound by leghemoglobin (plant proteins) similar to human hemoglobins. *Leghemoglobin* (legoglobin) is a





Amit Kumar et al.,

monomeric oxygen-carrying phytolegumin responsible for maintaining anaerobic conditions inside the legume to protect the activity of oxygen-sensitive nitrogenase [41]. Nitrogenase is the primary enzyme which catalyzes the process of biological nitrogen fixation in legumes [40]. However nitrogenase, an enzyme that is responsible for the reduction of nitrogen, is extremely sensitive to oxygen. *Frankia* sp. (gram positive) members of the *Actinomycete* family associated with a broad spectrum of plants collectively called Actinorhizal plants. It represent a diverse group of about 220 species belonging to eight plant families distributed in the three orders, Fagales (*Betulaceae*, *Casuarinaceae* and *Myricaceae*), Rosales (*Rosaceae*, *Eleagnaceae* and *Rhamnaceae*) and Cucurbitales (*Datisceae* and *Coriariaceae*) [42, 43]. They can also fix N<sub>2</sub> in free-living state similar to *cyanobacteria* and most *rhizobium* species. Under nitrogen limitation and aerobic conditions, *Frankia* strains form special organs for N<sub>2</sub>-fixation similar to nodules in legumes. Actinorhizal nodules consist of several lobes and each lobe has a similar structure as a lateral root. They also produce leghaemoglobin but their role is less established as in *rhizobia* [44]. This symbiotic process results in the formation of root nodules in which *Frankia* generates accessible nitrogen for the host in exchange of energy rich compounds [43].

*Cyanobacteria* are oxygenic photosynthetic bacteria that are distributed in marine, freshwater as well as in terrestrial environments. Fortunately, some of the filamentous cyanobacteria differentiate into specialized heterocysts. These heterocysts are deficient in oxygenic photosystem and have a cell wall that made up of glycolipid which keeps the favorable conditions for nitrogen fixation within heterocyst cells. *Cyanobacteria* are symbiotic type and associates with fungi, liverworts, fern, and cycad [45]. They do not form any nodules as most of the plants have no root structure but many of them are capable of fixing atmospheric nitrogen due to these heterocyst structures. *Azolla* is one of the important free-floating water fern that has agronomic importance due to its ability to fix nitrogen [46]. It generates a symbiotic process for nitrogen-fixation with the cyanobacterium *Anabaena azollae*, in the leaf cavity of the fern [43, 47]. In Asian countries, *Azolla* is the most commonly green manure that is used for rice crop. It possess high growth rate, nitrogen-fixing ability and sufficient to scavenge nutrients from soil and water. It can provide more than half of the nitrogen needed by rice crop [47]. **Termites** are obligate associated symbiotic gut microorganisms [48] that provide the enzymes which are helpful in degradation of plant polymers, synthesizing amino acids, recycle nitrogenous waste, and could also fix atmospheric nitrogen (N<sub>2</sub>) [49, 50]. However relation of symbiotic diazotrophs (N<sub>2</sub> fixing bacteria) with termite needs more stochastic and empirical studies [48, 51].

#### Isolation and characterization of diazotrophs

Plant growth promoting diazotrophs could be directly isolated from different tissues of plant such as (root, leaf, shoot) and in soil rhizosphere. They found freely or in association with root in soil of different crop system, which can improve the quality of plant growth and enhance the nitrogen directly in soil. The serial dilution spread plating technique is used to isolate pure culture of diazotrophs from soil. To isolate the diazotrophs from soil and other plant tissue different nitrogen deficient medium (Burk's, Jensen [52, 53, 54] were used to get the diverse population of diazotrophs. The morphology of isolated bacterial culture will be characterized using the method as in bergey's manual of systematic bacteriology [55]. Morphological (color, texture, margin, shape of the colony, motility) and physiological (gram, capsule, metachromatic and spore staining) characters could be analyzed using standard methods. The cell shape, motility and gram staining pattern has been observed using simple method as proposed by Sulaiman [56]. Furthermore, various biochemical tests such as indole, methyl red, ammonia production, nitrate reduction, triple sugar iron test, cellulase test, oxidase test, starch hydrolysis test, citrate utilization test, nitrate reduction test, urease test, and gelatin liquefaction test are the preliminary test for nitrogen utilization in nitrogen fixing colonies [57, 58, 59]. Concentration of nitrogen could also be determining using alkaline permanganate as per the modified Kjeldahl method [60]. Some of the histochemical assay could also helpful to analyze the presence of rhizobial bacteria [61]. In addition to this nitrogenase activity of bacterial colony has been assayed using the acetylene reduction assay (ARA). Gene sequencing is another approach to characterize the isolated colonies using *nif* gene and 16S rRNA sequencing.





Amit Kumar et al.,

## CONCLUSION

Due to unavailability of accessible nitrogen in ecosystem for plant growth and development it is an essential requirement to maintain the equilibrium of chemical nitrogen and biological nitrogen in between soil and atmosphere. Diazotrophs are the beneficial microorganisms with the ability to fix atmospheric nitrogen and convert it into biological form. They have long been recognized as functionally key members not only in terrestrial but also fix the nitrogen in ocean plankton. In biological nitrogen fixation diazotrophs play key role in soil improvement with enriched soluble nitrogen and sustain the agriculture land.

## REFERENCES

1. Leghari, S.J., Wahocho, N.A., Laghari, G.M., HafeezLaghari, A., MustafaBhabhan, G., HussainTalpur, K., Bhutto, T.A., Wahocho, S.A. and Lashari, A.A., 2016. Role of nitrogen for plant growth and development: A review. *Advances in Environmental Biology*, 10(9), pp.209-219.
2. Aasfar, A., Bargaz, A., Yaakoubi, K., Hilali, A., Bennis, I., Zeroual, Y. and MeftahKadmiri, I., 2021. Nitrogen Fixing Azotobacter Species as Potential Soil Biological Enhancers for Crop Nutrition and Yield Stability. *Frontiers in Microbiology*, 12, p.354.
3. Mahmud, K., Makaju, S., Ibrahim, R. and Missaoui, A., 2020. Current progress in nitrogen fixing plants and microbiome research. *Plants*, 9(1), p.97.
4. Demtröder, L., Narberhaus, F. and Masepohl, B., 2019. Coordinated regulation of nitrogen fixation and molybdate transport by molybdenum. *Molecular microbiology*, 111(1), pp.17-30.
5. Scheer, C., Fuchs, K., Pelster, D.E. and Butterbach-Bahl, K., 2020. Estimating global terrestrial denitrification from measured N<sub>2</sub>O:(N<sub>2</sub>O+ N<sub>2</sub>) product ratios. *Current Opinion in Environmental Sustainability*, 47, pp.72-80.
6. Signorelli, S., Sainz, M., Tabares-da Rosa, S. and Monza, J., 2020. The role of nitric oxide in nitrogen fixation by legumes. *Frontiers in Plant Science*, 11, p.521.
7. Pankievicz, V.C.S., do Amaral, F.P., Ané, J.M. and Stacey, G., 2021. Diazotrophic Bacteria and Their Mechanisms to Interact and Benefit Cereals. *Molecular Plant-Microbe Interactions*, pp.MPMI-11
8. Galloway, J.N., Dentener, F.J., Capone, D.G., Boyer, E.W., Howarth, R.W., Seitzinger, S.P., Asner, G.P., Cleveland, C.C., Green, P.A., Holland, E.A. and Karl, D.M., 2004. Nitrogen cycles: past, present, and future. *Biogeochemistry*, 70(2), pp.153-226.
9. Ladha, J.K., Jat, M.L., Stirling, C.M., Chakraborty, D., Pradhan, P., Krupnik, T.J., Sapkota, T.B., Pathak, H., Rana, D.S., Tesfaye, K. and Gerard, B., 2020. Achieving the sustainable development goals in agriculture: The crucial role of nitrogen in cereal-based systems. *Advances in Agronomy*, 163, pp.39-116
10. Li, Y., Wang, C., Wang, T., Liu, Y., Jia, S., Gao, Y. and Liu, S., 2020. Effects of Different Fertilizer Treatments on Rhizosphere Soil Microbiome Composition and Functions. *Land*, 9(9), p.329.
11. Ren, N., Wang, Y., Ye, Y., Zhao, Y., Huang, Y., Fu, W. and Chu, X., 2020. Effects of continuous nitrogen fertilizer application on the diversity and composition of rhizosphere soil bacteria. *Frontiers in Microbiology*, 11, p.1948
12. Sharma, P., Devi, G., Sharma, M., Mamrutha, H.M., Venkatesh, K., Tiwari, V., Singh, G.P. and Sharma, P., 2016. Biological nitrogen fixation in cereals: An overview. *Journal of Wheat Research*, 8(2), pp.1-11.
13. Chandini, K.R., Kumar, R. and Prakash, O., 2019. The impact of chemical fertilizers on our environment and ecosystem. *Research trends in environmental sciences*, pp.69-86.
14. Pahalvi, H.N., Rafiyya, L., Rashid, S., Nisar, B. and Kamili, A.N., 2021. Chemical Fertilizers and Their Impact on Soil Health. In *Microbiota and Biofertilizers*, Vol 2 (pp. 1-20). Springer, Cham.
15. Guo, Y. and Wang, J., 2021. Spatiotemporal Changes of Chemical Fertilizer Application and Its Environmental Risks in China from 2000 to 2019. *International Journal of Environmental Research and Public Health*, 18(22), p.11911.
16. Roberts, T.L., 2009. The role of fertilizer in growing the world's food. *Better crops*, 93(2), pp.12-15.





**Amit Kumar et al.,**

17. Johannes, A., Weisskopf, P., Schulin, R. and Boivin, P., 2019. Soil structure quality indicators and their limit values. *Ecological indicators*, 104, pp.686-694.
18. Lin, W., Lin, M., Zhou, H., Wu, H., Li, Z. and Lin, W., 2019. The effects of chemical and organic fertilizer usage on rhizosphere soil in tea orchards. *PLoS one*, 14(5), p.e0217018.
19. Savci, S., 2012. Investigation of effect of chemical fertilizers on environment. *Apcbee Procedia*, 1, pp.287-292
20. Ito, A., Nishina, K., Ishijima, K., Hashimoto, S. and Inatomi, M., 2018. Emissions of nitrous oxide (N<sub>2</sub>O) from soil surfaces and their historical changes in East Asia: a model-based assessment. *Progress in Earth and Planetary Science*, 5(1), pp.1-13.
21. Atilgan, A.T.I.L.G.A.N., Coskan, A.L.İ., Saltuk, B. and Erkan, M., 2007. The level of chemical and organic fertilizer usage and potential environmental impacts in greenhouses in Antalya region.
22. Craswell, E., 2021. Fertilizers and nitrate pollution of surface and ground water: an increasingly pervasive global problem. *SN Applied Sciences*, 3(4), pp.1-24.
23. Berg, M., Meehan, M. and Scherer, T., 2017. Environmental Implications of Excess Fertilizer and Manure on Water Quality. *NDSU Extension Service, NM1281*, p.2.
24. Lawrencía, D., Wong, S.K., Low, D.Y.S., Goh, B.H., Goh, J.K., Ruktanonchai, U.R., Soottitantawat, A., Lee, L.H. and Tang, S.Y., 2021. Controlled release fertilizers: A review on coating materials and mechanism of release. *Plants*, 10(2), p.238.
25. Kumar, R., Kumar, R. and Prakash, O., The Impact of Chemical Fertilizers on our Environment and Ecosystem Chapter-5 The Impact of Chemical Fertilizers on Our Environment and Ecosystem. 2019.
26. Rahman, A., Mondal, N.C. and Tiwari, K.K., 2021. Anthropogenic nitrate in groundwater and its health risks in the view of background concentration in a semi arid area of Rajasthan, India. *Scientific reports*, 11(1), pp.1-13.
27. Ward, M.H., Jones, R.R., Brender, J.D., De Kok, T.M., Weyer, P.J., Nolan, B.T., Villanueva, C.M. and Van Breda, S.G., 2018. Drinking water nitrate and human health: an updated review. *International journal of environmental research and public health*, 15(7), p.1557.
28. Dixon, R. and Kahn, D., 2004. Genetic regulation of biological nitrogen fixation. *Nature Reviews Microbiology*, 2(8), pp.621-631.
29. Burns, R.C. and Hardy, R.W., 1975. Description and classification of diazotrophs. In *Nitrogen Fixation in Bacteria and Higher Plants* (pp. 14-38). Springer, Berlin, Heidelberg.
30. Wang, X., Yang, J.G., Chen, L., Wang, J.L., Cheng, Q., Dixon, R. and Wang, Y.P., 2013. Using synthetic biology to distinguish and overcome regulatory and functional barriers related to nitrogen fixation. *PLoS One*, 8(7), p.e68677.
31. Jnawali, A.D., Ojha, R.B. and Marahatta, S., 2015. Role of Azotobacter in soil fertility and sustainability—A Review. *Adv. Plants Agric. Res*, 2(6), pp.1-5.
32. Minamisawa, K., Nishioka, K., Miyaki, T., Ye, B., Miyamoto, T., You, M., Saito, A., Saito, M., Barraquío, W.L., Teamroong, N. and Sein, T., 2004. Anaerobic nitrogen-fixing consortia consisting of clostridia isolated from gramineous plants. *Applied and environmental microbiology*, 70(5), pp.3096-3102.
33. Gupta, V.V., Zhang, B., Penton, C.R., Yu, J. and Tiedje, J.M., 2019. Diazotroph diversity and nitrogen fixation in summer active perennial grasses in a mediterranean region agricultural soil. *Frontiers in molecular biosciences*, 6, p.115.
34. Maheep, K., 2014. Bacteria involving in nitrogen fixation and their evolutionary correlation. *International Journal of Current Microbiology and Applied Sciences*, 3(3), pp.824-830.
35. Liu, D., Chen, L., Zhu, X., Wang, Y., Xuan, Y., Liu, X., Chen, L. and Duan, Y., 2018. Klebsiella pneumoniae SneBYK mediates resistance against Heteroderaglycines and promotes soybean growth. *Frontiers in microbiology*, 9, p.1134.
36. Xie, J.B., Zhang, L.H., Zhou, Y.G., Liu, H.C. and Chen, S.F., 2012. Paenibacillustaohuashanense sp. nov., a nitrogen-fixing species isolated from rhizosphere soil of the root of Caragana kansuensisPojark. *Antonie Van Leeuwenhoek*, 102(4), pp.735-741.
37. Castillo, T., García, A., Padilla-Córdova, C., Díaz-Barrera, A. and Peña, C., 2020. Respiration in Azotobacter vinelandii and its relationship with the synthesis of biopolymers. *Electronic Journal of Biotechnology*.Scheer,





**Amit Kumar et al.,**

- C., Fuchs, K., Pelster, D.E. and Butterbach-Bahl, K., 2020. Estimating global terrestrial denitrification from measured N<sub>2</sub>O:(N<sub>2</sub>O+ N<sub>2</sub>) product ratios. *Current Opinion in Environmental Sustainability*, 47, pp.72-80.
38. Bergman, B., Gallon, J.R., Rai, A.N. and Stal, L.J., 1997. N<sub>2</sub> fixation by non-heterocystous cyanobacteria. *FEMS Microbiology reviews*, 19(3), pp.139-185.
  39. Bergman, B., Sandh, G., Lin, S., Larsson, J. and Carpenter, E.J., 2013. Trichodesmium—a widespread marine cyanobacterium with unusual nitrogen fixation properties. *FEMS microbiology reviews*, 37(3), pp.286-302.
  40. MendozaLi -Suarez, M.A., Geddes, B.A., Sánchez-Cañizares, C., Ramírez-González, R.H., Kirchhelle, C., Jorriin, B. and Poole, P.S., 2020. Optimizing Rhizobium-legume symbioses by simultaneous measurement of rhizobial competitiveness and N<sub>2</sub> fixation in nodules. *Proceedings of the National Academy of Sciences*, 117(18), pp.9822-9831.
  41. Li, Y., Xu, M., Wang, N. and Li, Y., 2015. A JAZ protein in *Astragalus sinicus* interacts with a leghemoglobin through the TIFY domain and is involved in nodule development and nitrogen fixation. *PLoS one*, 10(10), p.e0139964.
  42. Franche, C. and Bogusz, D., 2012. Signalling and communication in the actinorhizal symbiosis. In *Signaling and communication in plant symbiosis* (pp. 73-92). Springer, Berlin, Heidelberg.
  43. Santi, C., Bogusz, D. and Franche, C., 2013. Biological nitrogen fixation in non-legume plants. *Annals of botany*, 111(5), pp.743-767.
  44. Ardley, J. and Sprent, J., 2021. Evolution and biogeography of actinorhizal plants and legumes: a comparison. *Journal of Ecology*, 109(3), pp.1098-1121.
  45. Chang, A.C.G., Chen, T., Li, N. and Duan, J., 2019. Perspectives on endosymbiosis in coralloid roots: association of cycads and cyanobacteria. *Frontiers in microbiology*, 10, p.1888.
  46. Singh, S., 2020. Effect of nitrogen application through urea and Azolla on yield, nutrient uptake of rice and soil acidity indices in acidic soil of Meghalaya. *Journal of Environmental Biology*, 41(1), pp.139-146.
  47. Bhuvaneshwari, K. and Singh, P.K., 2015. Response of nitrogen-fixing water fern Azolla biofertilization to rice crop. *3 Biotech*, 5(4), pp.523-529.
  48. Ohkuma, M. and Brune, A., 2010. Diversity, structure, and evolution of the termite gut microbial community. In *Biology of termites: a modern synthesis* (pp. 413-438). Springer, Dordrecht.
  49. Desai, M.S. and Brune, A., 2012. Bacteroidalesectosymbionts of gut flagellates shape the nitrogen-fixing community in dry-wood termites. *The ISME journal*, 6(7), pp.1302-1313.
  50. Wenli, S.U.N., Shahrajabian, M.H. and Cheng, Q., 2021. Archaea, bacteria and termite, nitrogen fixation and sustainable plants production. *NotulaeBotanicae Horti Agrobotanici Cluj-Napoca*, 49(2), pp.12172-12172.
  51. Sapountzis, P., De Verges, J., Rousk, K., Cilliers, M., Vorster, B.J. and Poulsen, M., 2016. Potential for nitrogen fixation in the fungus-growing termite symbiosis. *Frontiers in Microbiology*, 7, p.1993.
  52. Rennie, R. J. (1981). A single medium for the isolation of acetylene reducing (dinitrogen-fixing) bacteria from soils. *Can. J. Microbiol.* 27, 8–14. doi: 10.1139/m81-002
  53. Soni, R., Suyal, D. C., Agrawal, K., Yadav, A., Souche, Y., and Goel, R. (2015). Differential proteomic analysis of Himalayan psychrotolerant diazotroph *Pseudomonas palleroniana* N26 strain under low temperature diazotrophic conditions. *CryoLetters* 36, 74–82
  54. Das, S. and De, T.K., 2018. Microbial assay of N<sub>2</sub> fixation rate, a simple alternate for acetylene reduction assay. *MethodsX*, 5, pp.909-914.
  55. Holt, J.G., Krieg, N.R., Sneath, P.H., Staley, J.T. and Williams, S.T., 1994. Bergey's manual of determinative bacteriology. 9th. *Baltimore: William & Wilkins*.
  56. Sulaiman, K.H., Al-Barakah, F.N., Assafed, A.M. and Dar, B.A.M., 2019. Isolation and identification of Azospirillum and Azotobacter species from Acacia spp. at Riyadh, Saudi Arabia. *Bangladesh Journal of Botany*, 48(2), pp.239-251.
  57. Gordon, S.A. and Weber, R.P., 1951. Colorimetric estimation of indoleacetic acid. *Plant physiology*, 26(1), p.192.
  58. Móring, A., Hooda, S., Raghuram, N., Adhya, T.K., Ahmad, A., Bandyopadhyay, S.K., Barsby, T., Beig, G., Bentley, A.R., Bhatia, A. and Dragosits, U., 2021. Nitrogen challenges and opportunities for agricultural and environmental science in India. *Frontiers in Sustainable Food Systems*, p.13.





Amit Kumar *et al.*,

59. Aneja, K.R., 2007. *Experiments in microbiology, plant pathology and biotechnology*. New Age International.
60. LeylasiMarand, M. and Sarikhani, M.R., 2018. Evaluation of Biological Nitrogen Fixation by Azotobacter Isolates in Solid and Liquid LG Medium by Kjeldahl method. *Water and Soil Science*, 28(2), pp.207-218.
61. Nagalingam, S., Nithya, T.V., Gayathri, D., Sagarika, A.S., Supriya, G., Vidya, D., Kumar, B.K., Rasool, A. and Mir, M.I., 2020. Morphological, biochemical and plant growth promoting characterization of rhizobia isolated from root nodule of *Cajanus cajan* l. *Plant Archives*, 20(2), pp.1293-1299.

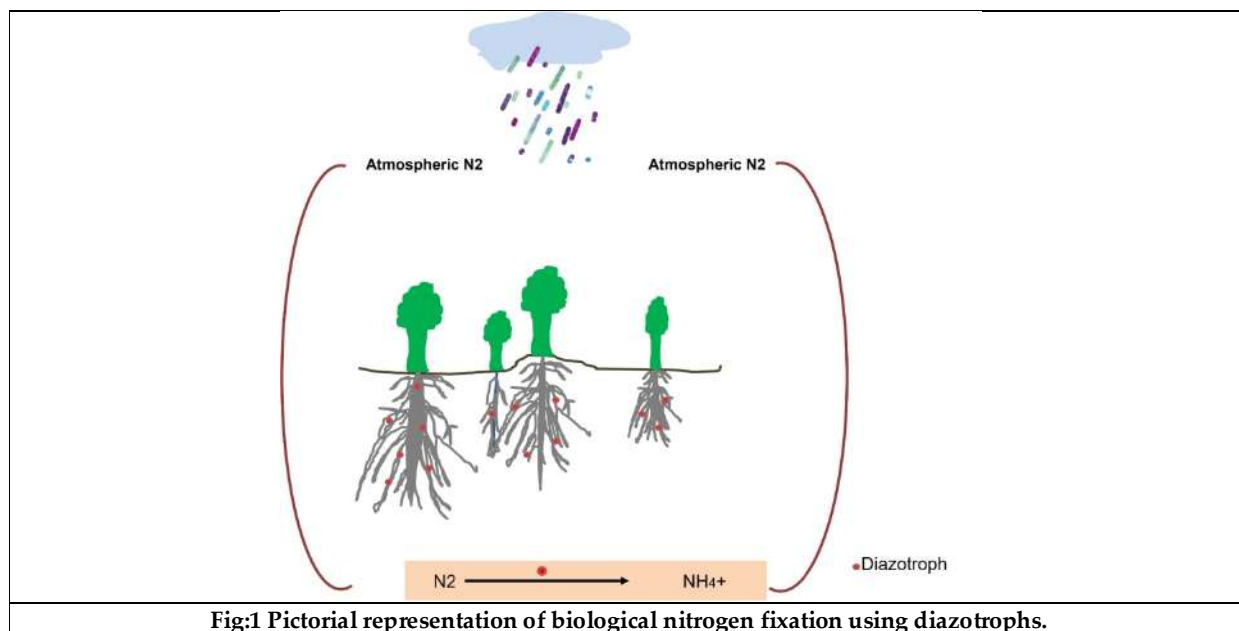


Fig:1 Pictorial representation of biological nitrogen fixation using diazotrophs.





## Yoga for Psychological-Immunity Factors : An Ancient Solution for Mental Health : A Literature Review

Haobijam Sonia Devi<sup>1\*</sup> and V.Suseela<sup>2</sup>

<sup>1</sup>Ph.D Research Scholar, Department of Yoga Studies, Annamalai University, Tamil Nadu, India.

<sup>2</sup>Assistant Professor, Department of Yoga Studies, Annamalai University, Tamil Nadu, India.

Received: 22 Jan 2024

Revised: 09 Feb 2024

Accepted: 27 Apr 2024

### \*Address for Correspondence

Haobijam Sonia Devi  
Ph.D Research Scholar,  
Department of Yoga Studies,  
Annamalai University,  
Tamil Nadu, India.  
Email: neviahaobijam21@gmail.com



This is an Open Access Journal / article distributed under the terms of the **Creative Commons Attribution License** (CC BY-NC-ND 3.0) which permits unrestricted use, distribution, and reproduction in any medium, provided the original work is properly cited. All rights reserved.

### ABSTRACT

Yoga is a practical discipline incorporating techniques whose goal is the development of a state of mental and physical health, well-being, and inner harmony. A large amount of evidence has already shown associations between yoga and physical health and mental health. However, a systematic approach to review existing studies examining the use of yoga in combination with psychological treatment is lacking. The objective of this review is to study the literature in search of older and recent evidence about how immunity and yoga interact especially on psycho-immunity or mental immunity. Selected subjects of the study are mainly articles and thesis. Most of the study focus on asana, pranayama, meditation. After deep reviewing all the results and conclusions of the sample we came to the conclusion that there is an important relationship between yoga and psychoimmunity of a body and also it is found that Yoga greatly helps in maintaining the mental health by cultivating the psychoimmunity factors.

**Keywords:** Psychoimmunity, yoga, mental health, asana, pranayama, meditation.

## INTRODUCTION

### Background

In this modern time where people are more engaged on physical health on the contrary the case of mental problems is on the peak. The problem face by the world for mental health is increasing rapidly everywhere including India. The Immune system of a body fight when there is any physical illness, similarly psychological immune system protects from the toxins generated from constant worry, nervous tension and anxiety which one experiences on the





**Haobijam Sonia Devi and Suseela**

daily basis. The psychological immune system, which brings about psychological immunity – is a construct that shares some similarities with the biological immune system [1]. For example, they both have self-healing and self-protective mechanisms; implicit immune system processes such as habituation and emotional processing are comparable to the biological immune system's adaptive immunity process in that they both support healing, are automatic, and function outside of human awareness. [2].

**Yoga**

The term yoga stands for "Yuj" which means "to unite" and refers to an inner state where one experiences everything as part of oneself. Often confused with a system of physical exercises, the yoga system is actually a set of tools for self-transformation designed to bring you into this state of union. The method and technologies to experience beyond the physical are known as Yoga Science [3]. In accordance with the yogic scriptures, practicing yoga results in the perfect harmony between mind and body, man and nature, as well as the merging of the individual consciousness with the Universal consciousness. Whereas according to modern scientists, all that exists in the universe is merely a manifestation of a single, quantum celestial body [4]. There are 4 main schools or system of yoga- Karma yoga, Jnana Yoga, Hatha Yoga and Raja Yoga. Apart from these there are many schools or systems of yoga like Kundalini yoga, Mantra Yoga, Tantra yoga, Laya yoga, etc. Different schools taught different system but their final goal is same. For this contemporary world of yoga, people give more emphasis only on asana, pranayama, meditation and less number of people practice shatkriya, mudra, bandha with proper recommendation of yogic diet.

**Psychological Immunity**

The main purpose of the physical immune system is to keep the body biologically safe and protected from foreign pathogens. Thus, it plays an important role in promoting health and survival, especially in the event of physical injury or infection [5]. In a similar vein, psychological immunity also builds a defence mechanism that aids in positive adaptation to traumatic, uncomfortable, and stressful circumstances. [6]. The nutrients for psychological immune system that researched prove so far may be optimism, future orientation, positive thinking, humour, resilience etc [7]. Olah(1996, 2000, 2002) had defined psychological immune system as "an integrated system of cognitive, motivational and behavioural personality dimensions that should provide immunity against stress, promote healthy development and serve as stress resistance resources or psychological antibodies". 16 adaptive resources interact to facilitate the psychological adaptation process and form the basis of the Psychological Immune System (PIS). This system is made up of 16 different types of mental health defences [8] namely positive thinking, sense of coherence, sense of self growth, sense of control, creative self-concept, self- efficacy, goal orientation, problem solving capacity, change and challenge orientation, social monitoring capacity, social mobilizing capacity, social creating capacity, synchronicity, impulse control, emotional control and irritability control. They are under the "Psychological Immunity System Inventory", design by Olah (2000, 2004). There are other models for psychological immunity like "Pentacles Model of Psychological Immunity", design by Bhardwaj and Agrawal (2023). Its 5 factors are self-esteem, overall adjustment, emotional maturity, psychological well-being and positive memories.

**Different factors of Psychological Immunity****Positive thinking**

It means the tendency of the individual to accept new ideas and knowledge that simplify everything that is complex [9], it facilitates anticipation of positive results in all life situations and encourage a person to believe that events are going in the right direction [10]. The most important value of positive thinking is optimism. People with high optimism expect positive outcomes and favourable outcomes even in situations beyond their control.

**Sense of Coherence**

It is the tendency to view life situations as foreseeable and manageable. The sense of coherence is of primary importance in determining the meaning of positive and negative life events. It is an individual method of being, thinking, and acting based on an inner sense of trust that helps people recognize, make use of, and recycle the resources available to them. (Eriksson and Lindström, 2006) [11].





**Haobijam Sonia Devi and Suseela**

**Sense of control** is widely studied phenomena which include different dimensions of control. Basically, it is an individual's sense of personal influence on various life events. Some people attribute the events and circumstances of their lives to their own actions, while others believes that their lives were shaped by external forces such as fate, chance, faith or other powerful forces [12].

**Sense of personal growth** is a feeling of successful self-expansion and personal growth. It gives you a sense of becoming healthy, mature and fully functioning individual. The expectation of a person's self-development encourages openness to new experiences [13].

**Social creating capacity**

The social competency that enables a person to form different social relationships in the form of social groups or teams is known as social creating capacity. This talent is associated with a personality that fosters a sense of community among others. With this ability in place, kids and teenagers can overcome feelings of loneliness and isolation in the age of smartphones and virtual relationships by learning appropriate social skills and forming genuine relationships [8].

**Social execution ability** refers to the abilities needed to lead, control, and oversee people resources in order to accomplish a variety of objectives. Individuals who score highly on this ability have strong communication, social assertiveness, and leadership abilities.

**Social monitoring ability**

The ability to monitor others socially entails having empathy for their worries. A person with a high level of social monitoring capacity will be more aware of social cues in their environment and other people's behaviour.

**Creative self-concept**

A creative self-concept is a person's perception of their own abilities and creative competence, which enables them to handle various life circumstances more skilfully [14].

**Change and challenge orientation** encourages individuals to face change in a more flexible way.

**Problem solving capacity**

The ability to find different approaches to solve different kinds of problems that arise in life.

**Self-efficacy** is an individual's belief on his own abilities to perform a certain task [15]. The belief that one can influence their own motivation, actions, and social surroundings is reflected in self-efficacy. These cognitive self-evaluations impact every aspect of the human experience, such as the objectives people pursue, the amount of effort they put forth to achieve those objectives, and the probability of achieving specific behavioural performance levels [16].

**Goal orientation**

The capacity to remain motivated and persistent in pursuing objectives despite a variety of setbacks and hardships. Prior to beginning an assignment or task, a person choose a goal orientation, which establishes a psychological framework within which they evaluate, interpret, and take action to pursue a specific task or activity goal [17]. Goal-oriented people have high levels of endurance and frustration tolerance.

**Synchronicity** is the ability to be present on task along with the awareness about the other environmental change. While a lack of synchronicity encourages behavioural disengagement and avoidance (maladaptive coping), a high level of synchronicity enables an individual to be present in the moment and focus as much as possible on the concurrent issues.



**Haobijam Sonia Devi and Suseela**

**Impulsivity control** is the ability to control impulses, rationalize behaviour and contemplate a decision before acting on it.

**Emotion control** is the ability to regulate emotions originated from stressful situations in day-to-day encounters. It involves learning to handle minor issues with composure and to react appropriately emotionally given the circumstances.

**Irritability control** refers to the regulation of mood and anger in a given situation. A person with poor anger management tends to lose their temper easily and often causes problems for themselves and others.

**Self-esteem:**

The concept of self-esteem suggests a deep appreciation of oneself and one's inherent qualities, as well as a faith in one's own intuition and skills. It's the kind of self-worth that, far from being narcissistic, allows us to live kindly and peacefully, free from crime or destructive behaviour, supporting one another in our development as individuals. Having self-esteem is believed to mean maintaining a positive attitude even in the most hostile circumstances [18]. The term self-esteem implies a deeply felt appreciation of oneself and one's natural being, a trust of one's instinct and abilities. This type of self-worth allows us to live philanthropically and harmoniously, free from crime or destructive behaviour, supporting one another in our development rather than being narcissistic [19]. Self-esteem is one's perception of oneself.

**Adjustment**

The extent to which a person found himself able and willing to live with them happily is known as self-adjustment. Individuals who have self-adjusted find it easier to adjust to their surroundings [20]. Self-adjustment factors can come from the outside or from within an individual. Physical state, maturity and development, mental state in terms of perception and self-concept, IQ, interests, and personality are examples of internal factors. The individual's upbringing, the social norms and customs of the community, the dominant culture, and the family and community environment are examples of the external factors [21].

**Emotional maturity**

Emotional stability is seen as a key element in mental health, and emotional maturity is thought to be one of the key factors in determining a person's personality, behaviour, and attitudes. It also helps to improve a person's relationships with others and their sense of self-worth [22]. "A process in which the personality always determined for better sense of emotional well-being" is how Menninger (1999) defines emotional maturity [23]. In the event that an individual or child is emotionally developing, they may possess the ability to effectively adjust to their surroundings, peers, family, society, and culture. He is capable of taking full advantage of his adjustment. As a result, it is regarded as a person's capacity to regulate their own emotions [24].

**Psychological well-being**

Psychological well-being refers to how well our lives are going. It is the union of well-being and efficient operation. It is not necessary for people to always feel happy or content; experiencing negative or painful emotions (such as disappointment, failure, or grief) is a natural part of life, and being able to control these emotions is crucial for long-term wellbeing [22]. A complicated concept, psychological well-being refers to the best possible psychological experiences and functioning. It can be characterized as encompassing resilience (coping, emotion regulation, constructive problem solving) along with hedonic (enjoyment, pleasure) and eudaimonic (meaning, fulfilment) happiness [23, 24, 25, 26, 27]. A balanced sense of emotion, thought, social interactions, and interests are elements of psychological well-being [26, 24, 27, 25]. Emotion regulation refers to the mechanisms that allow us to regulate the emotions we feel, when we feel them, and how we express them [28].



**Haobijam Sonia Devi and Suseela****Positive memories of the past**

Positive recollections from the past are an additional and crucial aspect of psycho-immunity. Similar to remembering, forgetting is a natural ability of the human mind, but what one remembers and forgets matters. According to Freud, the formation of a neurosis is primarily shaped by three elements: development, fixation, and regression. An individual becomes ready to see the invisible thread that links his current problems to past failures when they are unable to handle difficult situations. This results in powerlessness [29]. Through the interplay of these dimensions, an individual can enhance their strength, endurance, and capacity to collaborate with threats without compromising their personality in any way. Therefore, in order to achieve greater levels of strength, adaptation, and psychological well-being, or happiness, psychological immunity creates a balance between the individual and his environment [30].

**MATERIALS AND METHODS**

The search was done online in google scholar, shodhganga, pubmed and manual search also carried out to make the search exhaustive and identified all the studies done on the effect of different factors of psychological immunity. The key words used were yoga, mental health, psychoimmunity, self -esteem, psychological well-being, positive memory, goal orientation, emotional maturity. For this study the base year is 2010- 2023.

**YOGA FOR DIFFERENT FACTORS OF PSYCHOLOGICAL IMMUNITY****Studies pertaining to change the self-esteem**

Amandeep (2021) studied the effect of yoga on self-esteem stress and aggression among orphanages and found in the studies that the general self-esteem and parental self-esteem enhanced in the yoga set ( $p < 0.0001$ ). It is also reported different self-esteem parameters with physical activity [31]. He used a yoga protocol designed by Acharya Balkrishan ji. In Indian schools, it is customary to begin and conclude every activity with prayer. They applied the same prarthana principle when creating the yoga protocol. In the present study, Pranayama (8) for 15 minutes, Asana (11) for 40 minutes, Sukshma vyayama for 5 minutes is performed, Shavasana was used in the present study. It is discovered that the school children who continued practicing yoga on a regular basis displayed reduced levels of stress, aggression, and enhanced self-esteem. The relationship between self-esteem and performance with other children of the same age, gender, and educational background is characterized by a type of self-accommodative behaviour. Paranjape and Mrunal (2022) reported that on the three aspects of Core self-evaluations namely Self-Esteem, Self-Efficacy, and Locus of Control, no significant effect of Yoga intervention was obtained. No statistically significant change was seen on these variables in the experimental group than the control group [32].

Dagar and Pratibha (2022) had investigated the effect of meditation and physical activities training on self- esteem for hearing impairment students. For this study they selected a total sample of 120 male students with Hearing Impaired (who had given their consent for this study) was chosen purposively from age group of 12 to 18 years as per the inclusion and exclusion criteria of the study. The samples are distributed in three experimental groups and one control group randomly. After giving intervention among the experimental group for eight weeks, they used Rosenberg's Self Esteem Scale by Rosenberg, (1979) for measurement of their Self- Esteem were once again administered as post- test to the subjects of all the four groups. From their findings they conclude that the meditation and physical activity training are found effective on targeted symptom i.e., self-esteem but the combine approach was highly effective in compare to the approach used alone [33]. Sourabh (2023) found in his study on the efficacy of yoga on self-esteem cognition and behaviour and symptoms of people with alcohol use disorder that self- esteem which was measured by the Rosenberg self-esteem questionnaire showed significant improvement ( $p < 0.05$ ) in their scores, indicating an improvement in self -esteem. The study findings showed increased self-esteem in both groups, but the yogic intervention group effects were noticeably more pronounced [34]. For this study, a group of yoga practices including asanas, pranayamas, and meditation, etc., was selected as a study intervention as an add-on to the regular rehabilitation program. Dol (2019) found that people who practice yoga nidra also exhibit significantly higher levels of self-esteem than people who do not. In this study, the intervention period is 8 weeks [35]. Self-esteem



**Haobijam Sonia Devi and Suseela**

is generally influenced by stress, and stress is considered a trigger to lower self-esteem. Based on theoretical frameworks, these results suggest that yoga nidra enhances participants self-esteem by reducing their stress levels. Thus, the current study offers more proof that the parasympathetic nervous system's activity may be enhanced by the relaxation mechanism and effects of yoga nidra, thereby lowering mental and psychological stress and raising self-esteem [36]. Furthermore, research has examined the impact of yoga nidra on psycho-neuro-physiological factors, specifically regarding elevated electroencephalogram (EEG) frequency, heightened dopamine and imipramine secretion, and other hormones linked to psychological variables [37]. It is also mentioned that in order to comprehend the neurophysiological effects of yoga nidra, more research is needed. Moreover, earlier research revealed low self-esteem in college students, but only a small number of studies used yoga nidra to raise these students' self-esteem [38-39, 35, 40]. This suggests that in order to lessen the stress of college life and boost self-esteem in a variety of learning environments, a strategy's development and efficacy assessment are necessary. Yasmin *et al* (2020) have revealed that there was a significant difference in the self-esteem of the teenager practicing yoga compared to the non-yoga group. The study was conducted among 110 senior secondary students of Sarkaghat Tehsil of Mandi district (Himachal Pradesh), which was further divided into 52 subjects for experiment group and 58 for control group [41]. Experimental subjects were examined by using *Rosenberg Self Esteem Scale* [42]. Ravishankar *et al* (2019), undergone a pilot study about the effect of yoga on self-esteem among orphanage residents and they stated that adolescents and young adults in orphanages may see an improvement in their sense of self. The study was conducted for 2 weeks so they concluded that the final findings need confirmation from studies with a larger sample size and randomized controlled design, which are implicated in the future [43].

Kankan *et al* (2019) perform a study on the topic "Self-Esteem and Performance in Attentional Tasks in School Children after 4½ Months of Yoga". They come to the conclusion that after practicing yoga for 45 minutes a day for four and a half months, there was a significant improvement in the scores of social self-esteem ( $P < 0.01$ ), academic self-esteem ( $P < 0.001$ ), and total self-esteem ( $P < 0.001$ ). The t-test for paired data was used to analyze the results using PASW IBM SPSS Statistics 24 (Armonk, New York) [44]. Golecdeet *et al* (2017) examined the psychological effects of doing yoga poses in a study. The study investigated how yoga poses affected participants' subjective sense of power and self-worth. For a minute, each participant held a different yoga pose. Two standing yoga poses with an open front body, two standing yoga poses with a covered front body, two expansive, high-power poses, and two constrictive, low-power poses were among the postures. The findings showed that self-esteem was raised by yoga poses as opposed to "powerposes." Moreover, the study claimed that even brief yoga practice—as little as two minutes—can have a beneficial impact on wellbeing [45]. Another study by Koch *et al* (2017) sought to determine how yoga affected breast cancer survivors' quality of life, menopausal symptoms, and sense of self. A total of forty breast cancer survivors participated in the study, and their projections of yoga's effects on menopausal symptoms and self-esteem were compared using a secondary analysis of a randomized controlled trial. Self-rating tools were used to measure the response. The study's conclusions demonstrated that yoga enhances self-esteem and offers long-term advantages to women with breast cancer and going through menopause [46]. Another study by Rajesh (2015) on the topic "effect of yoga and gender on self-esteem and aggression" was conducted. The purpose of the study is to determine the self-esteem levels of yoga performers and non-performers. The sample consists of 160 male and female students in Jalna City, ages 15 to 25. Two-way ANOVA was used for the dependent variables in the study. The Dr. A.K. Srivastava Self-esteem Inventory was employed. Students who performed yoga were found to have higher levels of self-esteem than those who did not [47].

**Studies pertaining to self -adjustment:**

Vivek and Arti (2018) study about the effect of Preksha meditation on Adjustment among College going girls. For this study 100 adolescent girls with age range between 17 to 19 years were randomly allocated into two group i.e., 50 samples for experimental group and 50 for non-experimental group. Experimental group underwent the intervention for 2 months. Both the groups were assessed using Bell's Adjustment Inventory. After that the experimental group practiced Yoga-Preksha Meditation, 50 minutes daily for two months continuously and finally showed a significant reduction in level of all the dimensions of adjustment mentioned in Bell's Adjustment Inventory i.e., home, health, social and emotional. Thus, it indicates that the practice of Yoga-Preksha Meditation significantly improved the level



**Haobijam Sonia Devi and Suseela**

of adjustment ( $p < 0.001$ ;  $p < 0.001$ ;  $p < 0.001$  &  $p < 0.05$ ) in college going girls [48]. Martini and Asli (2023) have conducted a qualitative descriptive analysis about the Fostering Self-acceptance in Adolescents through Regular Practice of Surya Namaskara Yoga. They analysed the concept and come to the result that with the practice of Surya Namaskara Yoga, adolescents are able to comprehend themselves with all psychological processes and their weaknesses. It can increase self-acceptance. The quality of life of teenagers will suffer if they are unable to develop self-acceptance. *With a growing awareness for better self-acceptance, Surya Namaskara Yoga practitioners can align themselves with cosmic traits and rejuvenate life.* It is further concluded that by practicing *Surya Namaskara Yoga* every morning can awaken the solar aspect of human nature and release this vital energy for raise of a higher consciousness. So, they recommended to practice *Surya Namaskara Yoga* every day for balance and increase mental stability so that can be fosters better self-acceptance [49].

**Studies pertaining to emotional maturity**

Muchhal and Kumar (2015) found that practice of yoga effects the emotional maturity among B.Ed students from colleges of Ambala Districts. The study was examined by Emotional Maturity Scale by Yashvir and Mahesh (1990). For this purpose they used 100 students and split into two groups (experimental group and control group) each group consisted of 50 students. Over the course of 30 days, the experiment group involved regular morning meditation, yoga poses (Kapalbhati and Trataka), and pranayamas (Anulom-Vilom, Shitali, Shitkari, and Bhramari) [50]. After the study they come to the conclusion that when one's emotion is stable through yoga practices then it can effect our nervous system and glandular system which makes our emotional matured. Among the system of yoga, Bhakti yoga is also practice by millions of people worldwide. Kirtan is supposed as second type of bhakti in 'Navdha Bhakti'. Shravana, Kritan, Smran, Padsevan, Archan, Vandan, Dasya, Sakhya, Aatmnivedana are Navana Bhakti (Shrimadbhagavat-6/5/23) [51]. Rani (2015) has also studied on the effect of Kritan on Emotional Maturity among the students of Dev Sanskriti Vishwavidyalaya, Haridwar. After one month practice of Kritan for half an hour everyday it is found that t-value is significant at 0.01 level of confidence and is concluded that Kirtan increases Emotional Maturity [52]. A study by Berwal and Gahlawat (2013) intended to investigate whether yoga practice improves visually impaired students' self-concept and emotional development. Fifteen visually impaired students who were specifically selected from a School for the Blind made up the sample. The subjects underwent a four-week yoga training program that was specifically designed for intervention purposes. The Saraswat Self-Concept Inventory was used to assess how yoga affected visually impaired students self-concept, and Yashvir and Mahesh Bhargava's Emotional Maturity Scale was used to assess how yoga affected students' emotional maturity.

The 't' test, mean, and SD were used to analyze the data. According to the findings, visually impaired students levels of emotional maturity and self-concept improve after practicing yoga, and there are statistically significant differences in the mean gain scores on all dimensions of the Emotional Maturity Scale and Self-Concept Inventory [53]. The study "Role of Pranayama in Emotional Maturity for Improving Health" by Joshi *et al* (2033) sought to determine whether yoga influences emotional maturity and quality of life or if it is independent of both. Yoga was being practiced by 160 PG and graduation-level students, 160 of whom were female. Their months of yoga experience and the number of minutes they practiced each day were noted, along with their emotional maturity and overall quality of life. The five domains of emotional maturity are emotional stability, emotional progression, social adjustment, personality integration, and independence. Pearson correlation was used to examine the relationship between the months of yoga experience, the minutes of intense yoga practice, and the emotional maturity and quality of life dimensions. A one-time assessment of the cross-sectional research design was used. The study's conclusion was that yoga fosters greater emotional development. However, not every dimension is related to yoga. It was discovered that, based on self-reported emotional experiences and incidental physiological responses, we can conclude that students' emotional maturity is unaffected by yoga. Yoga affects our neurological and glandular systems, which makes us emotionally mature, but it cannot make us emotionally stable [54].



**Haobijam Sonia Devi and Suseela****Studies pertaining to Psychological well - being**

In relevance to the investigation about the influence of yoga on psychological well-being. Jarry et al (2017) underwent a study about the effectiveness of Astanga Yoga on psychological well-being. Astanga yoga is a traditional style of yoga that combines controlled breathing and strenuous exercise to physically induce a meditative state. In this study they showed the improvement of psychological well -being. During a nine-week period, eighteen Ashtanga yoga classes were offered to non-clinical volunteers twice a week. Before classes began, after the tenth class, and after the last class, the volunteers completed measures of depression, anxiety, affect, self-esteem, and interpersonal functioning, which were the factors of psychological well -being. 13 of the 44 participants who made at least one class attended an average of eleven classes (range = 5–18) and completed all three measurement points [55]. Another cross-sectional study was analyze by Parkinson et al (2023) about the experience of yoga on various factors related to psychological well -being. Only consistent practitioners are examined, not "casual" sporadic yoga experience. For the study 129 long term practitioners, 161 intermittent and 164 non- practitioners are collected and measures the variables of psychological well -being like emotional regulation, trait mindfulness, self-comparison, interoceptive awareness and spiritual intelligence. Results showed that on measures of mindfulness (MLT= 137.3; MIE=127.6), interoceptive awareness (MLT= 3.4; MIE=3.1), self-compassion (MLT= 3.4; MIE=3.1), and spiritual intelligence (MLT= 63.5; MIE=55.5; all p-value<0.05), long-term practitioners (LT) outperform intermittent experience (IE) practitioners. In terms of interoceptive awareness (MLT=3.1; MNE=2.7) and spiritual intelligence (MLT=55.5; MNE=46.6; both p-value < 0.05), intermittent practitioners performed better than the no-experience (NE) group [56].

Timlin et al. (2017) investigated the effects of dru yoga on psychological well-being in first-time mothers in northern-Ireland through a preliminary randomised control trial. Dru yoga is based on hatha yoga and consists of traditional asanas (yoga poses), mudras (gestures), breath work, positive affirmations, empowering visualizations, and strong, dynamic sequences. The Sanskrit term "Dhruva" which denotes stillness, is where the word "Dru" originates [57]. For the above study 16 participants are randomized with Dru yoga practice for 1hr daily for 4 weeks and 16 participants in control group. A repeated measures factorial Analysis of Variance revealed that at follow-up, the Dru yoga intervention group had higher levels of problem-focused coping and lower levels of stress, negative affect, and dysfunctional coping than the control group ( $P<0.05$ ) [58]. A non-randomized study on the impact of yoga on men's psychological well-being was also examined by Borotikar (2023). 90 retired men between the ages of 60 and 75 participated in this study using purposive sampling. A daily 90-minute session at a yoga training centre in Pune, India, was part of the 14-week intervention program. Each session included breathing techniques, relaxation techniques, light exercise, and meditation. Using Ryff's validated scale, psychological well-being was measured in six domains. A t-test was used to analyze the data. Finally, it can be said that integrated yoga practice significantly improved well-being ( $p < 0.05$ ), indicating that yoga can help retirees' psychological well-being [59]. Another study investigated by Shambhu (2018) about the change of psychological wellbeing of orphan children by Yoga. This study assesses how yoga can improve orphan psychological wellbeing.

The participants were chosen from an orphanage that offered the kids regular care. Assessments were conducted on a variety of psychological profiles, including mindfulness, depression, positive and negative affect, happiness, and emotion regulation. The results of the 12-week study's unblinded treatment and blinded outcome assessment indicate that the yoga-based intervention significantly improved participants' psychological wellbeing. According to this study, yoga-based interventions for orphan children's emotional and behavioural wellbeing in an orphanage setting may be feasible and even beneficial [60]. Yadav and Pooja (2021), study on the topic of "Efficacy of Yoga Intervention on Psychological Well- being among Postpartum Women". The variables of psychological well- being for this study includes anxiety, depression, life satisfaction and adjustment. After examining the data it is found that Pre-test mean scores are greater than post-test mean scores in all dimensions of anxiety test i.e. Tension ( $9.20\pm 2.20 > 5.30\pm 0.94$ ); Guilt Proneness ( $11.90\pm 1.59 > 6.10\pm 1.28$ ); Maturity ( $7.70\pm 1.05 > 5.70\pm 1.16$ ); Suspiciousness ( $8.60\pm 2.50 > 5.70\pm 1.16$ ); Self- control ( $8.90\pm 1.37 > 5.10\pm 0.73$ ); overall ( $46.30\pm 1.41 > 27.90\pm 1.19$ ) which means that subjects of treatment group show decrease in anxiety level through yoga intervention. Also the pre- test mean scores are greater than post-test mean scores in postpartum depression symptoms screening scales assessment i.e. Sleeping/Eating Disturbances ( $11.60\pm 1.77 > 6.10\pm 0.87$ ); Anxiety/Security ( $11.70\pm 2.00 > 5.70\pm 0.67$ ); Emotional Labilty ( $13.30\pm 2.35 >$



**Haobijam Sonia Devi and Suseela**

6.70±0.82); Mental Confusion (11.30±1.16 > 6.30±1.05); Loss of Self (12.50±1.43 > 6.60±1.17); Guilt/Shame (11.0±1.49 > 6.50±0.70); Suicidal Thoughts (6.80±1.31 > 5.90±0.56); overall (78.20±1.39 > 43.80±2.61). It is clear that the yoga intervention reduced the postpartum depression levels of the treatment group's participants. For life satisfaction variables, the Pre-test mean scores are less than post-test mean scores of Health i.e., (4.40±0.84 < 9.40±0.69); Personal (5.60±0.69 < 9.10±0.87); Economic (5.40±0.84 < 9.10±0.56); Marital (5.50±0.97 < 9.20±0.63); Social (6.40±1.07 < 9.30±0.48); Overall (27.30±0.67 < 46.10±0.87). It could be concluded that subjects of treatment group show increase in Life satisfaction level through yoga intervention. Lastly for adjustment the overall score for pre-test and post-test mean is (73.50±5.06 < 95.00±5.16). This implies that subjects of treatment group show increase in Adjustment level through yoga intervention [61].

**Studies pertaining to memory specially those positive memory**

Smiriti, also called Smaran, is the Sanskrit word for memory. The subconscious mind, also known as the Chitta, is responsible for memory. The Sanskar, or ways of thinking and behaving, are deeply ingrained in the Chitta, which functions similarly to a camera's sensitive plate in that every impression is purposefully recorded. Every time when we recall past experiences or things, they resurface in our minds as mental images or strong thought waves. This is known as the trap door [61]. According to the Freudian psychoanalysis those which are traumatized will be regress in and will be a probable victim of neurosis in their later years of life. Further the failure to deal with the challenging situation in the past provide a readiness for the subject to notice the invisible thread to connect his present moment issues with the failures of past. Yoga, in particular, has emerged as a means of reconnecting with the body and developing a greater sense of engagement to our feelings, thoughts, and memories within the psyche [62]. LaChiusa (2016) found in a study about the transformation of ashtanga yoga on implicit memory, dreams, and consciousness for survivors of complex trauma that a large majority of participants (90.3%) reported that yoga practice helped them "a lot", the remaining participants said that practicing yoga helped them feel better "a little bit" (3.2%) and "somewhat" (6.2%). Interviews were conducted to obtain qualitative data, and from the participant's real-life experiences, recurring themes surfaced. Furthermore, in the survey section designed by the researcher, a significant proportion of participants (90.3%) stated that their mental health improved as a result of their Ashtanga yoga practice. In a similar line, almost 97% (96.8%) of respondents claimed that doing yoga had "a lot" improved their body awareness. The high frequency of self-reported emotional abuse and neglect among survey respondents indicates that these experiences may have detrimental effects on a person mental health [63]. Emotional reactions which involve changes in experience, expression, and physiological arousal. Emotions can be caused by internal events such as thoughts or memories, or by specific external events [64].

**Studies pertaining to psychoimmunity**

In a review paper about the study of Defence Mechanisms and Psycho-Immunity on Gender and the use of Indigenous Techniques to Improve Psycho-Immunity by Gumber *et al* [65], it is concluded as by integrates and involves the use of indigenous techniques like consuming brain tonics, behavioural rasayana (code of conduct), following golden rules of happiness (lifestyle and philosophy), practicing Ashtanga yoga, yajna and satvik karma, having good somatic health, improvement of mental and bodily pollution, balancing three pillars of health (vata-pitta-kapha), balancing three sub-pillars of health (aahar-nidra- brahmacharya), and practicing spiritual yogic practices like pragyayogsadhna., improve the psycho-immunity. This paper shows the importance of other limbs of yoga in the development of psycho-immunity of a person. Another study conducted by Pandey (2022) on the effect of Yogic Intervention Program on Psychological Immunity of the Active Armed Forces Personnel of India. Psycho-Immunity Scale (PIS) was used to assess the level of psycho-immunity of the personnel. For the study 40 samples were collected and divided into two groups i.e., 20 in experimental and 20 in control group. After analysis the data it was found that there was significant difference between the experimental and control group after yoga intervention. And the study concluded by saying that the yoga intervention program significantly enhanced the level of psychoimmunity of the armed forces personnel. The intervention program developed in this study can be applied to other populations also. The practice of yoga should be part of the training of the armed forces. It will enhance their overall functioning [66].





**Haobijam Sonia Devi and Suseela**

## RESULT AND DISCUSSION

This review included 26 studies in total. Of these, 2 focus on direct psychoimmunity and the other 24 examine various individual components of psychological immunity. According to these studies, yoga-based interventions improve mental health and well-being and reduce stress reactivity in a variety of populations. Yoga-based therapies have an impact on psychological processes such as positive memories, emotional maturity, self-worth, and general adjustment. The majority of research focuses on psychological well-being, emotional development, and positive self-esteem; however, self-adjustment and positive memories of the past are rarely studied. Asana, pranayama, and meditation make up the majority of the intervention; however, other limbs such as mantra chanting and mudras are not included. Furthermore, it is discovered that the majority of research only includes young participants. The combination of physical postures, breathing techniques, and meditation results in a comprehensive approach to wellbeing that tackles several aspects of psychological wellness. From what we have discuss in the results it follows that when mental health or psychological health is improve it is due to the improvement of the psychological immunity which act as a shield/protector for different kind of mental disease or problems like stress, anxiety, depression etc. Psycho-immunity is not a novel concept; it has been around for a while. However, advancement in this area and the use of psychophylaxis in the structure of modern health care has been incredibly slow. Immunization against mental illness is achievable through the use of straightforward techniques. Further research should explore the potential interaction between yoga and psychoimmunity.

## RECOMMENDATION

It is strongly recommended that larger, more thorough studies with better methodological quality and sufficient control interventions be conducted because yoga has the potential to be used as a helpful supportive/adjunct treatment that is reasonably priced, can be practiced as a self-care behavioural treatment, imparts a lifelong behavioural skill, boosts self-efficacy and self-confidence, and is frequently linked to other positive side effects. It is advised to conduct more research on various age groups using various interventions, such as yama, niyama, mantras, suryanamaskara, etc.

## REFERENCE

1. Rachman SJ. Invited essay: Cognitive influences on the psychological immune system. *J BehaviorTherap Exp Psychiatry* 2013;53, 2-8
2. Kaur, T., & Som, R. R. The predictive role of resilience in psychological immunity: A theoretical review. *Int. J. Curr. Res. Rev.* 2020 12, 139-143.
3. Shadguru website: <https://isha.sadhguru.org/yoga/> Yoga: Its Origin, History and Development April 23, 2015 \*By Dr. Ishwar V. Basavaraddi Psychoneuroimmunology of Stress and Mental Health George M. Slavich 2019
4. Examining the Associations between Psychological Immunity and the Exams Anxiety in the Context of the Covid-19Pandemichttps://www.scirp.org/journal/articles.aspx?searchcode=Waleed+Khalid+Abdulkareem++Baban&search field= authors&page=1 ,2023
5. Dubey A, Shahi D. Psychological immunity and coping strategies: A study on medical professionals. *Indian J Soc Sci Res.* 2011;8(1-2):36-47.
6. Gupta T, Nebhinani N. Building Psychological Immunity in Children and Adolescents. *Journal of Indian Association for Child and Adolescent Mental Health.* 2020 Apr;16(2):1-2.
7. Shawkat OZ, Thamer AH, Freh FM. THE EFFECTIVENESS OF A PROGRAM TO ENHANCE PSYCHOLOGICAL IMMUNITY TOWARDS STRESSES RELATED TO EPIDEMIC DISEASES (CORONA VIRUS AS A MODEL). *PalArch's Journal of Archaeology of Egypt/Egyptology.* 2021 Dec 26;18(09):1749-61.



**Haobijam Sonia Devi and Suseela**

8. Lazarus RS. From psychological stress to the emotions: a history of changing outlooks. *Annu Rev Psychol.* 1993, 44:1–21
9. Eriksson M, Lindström B. Antonovsky's sense of coherence scale and the relation with health: a systematic review. *Journal of epidemiology and community health.* 2006 May;60(5):376.
10. Nafees, Nida. Fear of rejection sense of control and mental health among adolescents of majority and minority community. 2019 <http://hdl.handle.net/10603/528147>
11. Maslow AH. Self-actualizing people: a study of psychological health. *Personality, Symposium 1950*, 1:11-34.
12. Karwowski M, Lebuda I, Feist GJ, Reiter-Palmon R, Kaufman JC. Creative Self-Concept: A Surface Characteristic of Creative Personality. 2017, In G. J. Feist, R. Reiter-Palmon, & J. C.
13. Andrew Mecca, Neil J. Smelser, John Vasconcellos University of California Press. *The Social Importance of Self-Esteem* edited by Andrew Mecca, Neil J. Smelser, John Vasconcellos. 15 Aug 1989. <https://books.google.com/books?hl=en&lr=&id=u0-utTapxaUC&oi=fnd&pg=PR7&dq=social+esteem&ots=79aRTsXPR0&sig=q2fkLMNYRaF2AEfXRrX8ZkNXY>
14. Bandura A. Social cognitive theory of mass communication. In: *Media effects: Advances in theory and research.* Hillsdale, NJ, US: Lawrence Erlbaum Associates, Inc; 1994, p. 61–90.
15. Desalegn Alemu Jenbere. Effects of goal orientation study habit and procrastination on Ethiopian higher education students academic achievement. 2017. <http://hdl.handle.net/10603/359382>
16. Carey MP, Forsyth AD. Teaching tip sheet: Self-efficacy. American Psychological Association. 2009.
17. Hidayah, R. Students' Self-Adjustment, Self-Control, and Morality. *Journal of Social Studies Education Research* Volume 12, Number 1, Mar 26, 2021 Publisher: <https://www.learntechlib.org/p/219413/>
18. Schneiders, A. A. Personal adjustment and mental health. 1964. Rinehart and Winston.
19. Anand AK, Kunwar N, Kumar A. Impact of different factors on Social Maturity of Adolescents of Coed-School. *Int. Res. J. Soc. Sci.* 2014;3:35-7.
20. Rajeshwari RR, Raj JM. Opening of new insights for the researchers: A descriptive study on emotional maturity. *International Journal of Engineering & Management Research.* 2015;5(11):1-2.
21. Huppert FA. Psychological well-being: Evidence regarding its causes and consequences. *Applied psychology: health and well-being.* 2009 Jul;1(2):137-64.
22. Gross JJ, Muñoz RF. Emotion regulation and mental health. *Clinical psychology: Science and practice.* 1995;2(2):151.
23. Ryff, C. D. Psychological well-being in adult life. 1995, *Curr. Dir. Psychol.* 4, 99–104. doi: 10.1111/1467-8721.ep10772395 Cross Ref Full Text | Google Scholar
24. Ryan, R. M., and Deci, E. L. On happiness and human potentials: a review of research on hedonic and eudaimonic well-being. 2001, *Annu. Rev. Psychol.* 52, 141–166. doi: 10.1146/annurev.psych.52.1.141 PubMed Abstract | CrossRef Full Text | Google Scholar
25. Community Translational Science Team. Policy report: Building a public health model for promoting emotional well-being. Los Angeles: University of California. 2016.
26. Bethesda, MD. Emotional Well-Being: Emerging Insights and Questions for Future Research. NIH Report. (2018).
27. Brown, K. W., and Ryan, R. M. The benefits of being present: mindfulness and its role in psychological well-being. 2003, *J. Pers. Soc. Psychol.* 84, 822–848. doi: 10.1037/0022-3514.84.4.822. PubMed Abstract | CrossRef Full Text | Google Scholar
28. Feller, S. C., Castillo, E. G., Greenberg, J. M., Abascal, P., Van Horn, R., Wells, K. B., et al. Emotional well-being and public health: proposal for a model national initiative. 2018, *Public Health Rep.* 133, 136–141. doi: 10.1177/0033354918754540. PubMed Abstract | CrossRef Full Text | Google Scholar
29. Singh N. Effect Of Yoga On Self Esteem Stress And Aggression Among Orphanages.
30. Paranjape MD. Effect of yoga on Psychological well being self esteem self efficacy locus of control and neuroticism. 2022
31. Dagar, Pratibha. Effect of Meditation and Physical Activities Training on Cognitive Ability Behavioral Problems and Self Esteem of Students with Hearing Impairment.





### Haobijam Sonia Devi and Suseela

32. Sourabh Kukreti. Efficacy of Yoga on Self Esteem Cognition and Behaviour and Symptoms of People with Alcohol Use Disorder.
33. Kim Sang Dol, Effects of a yoga nidra on the life stress and self-esteem in university students, *Complementary Therapies in Clinical Practice*, Volume 35, 2019, Pages 232-236, ISSN 1744-3881, <https://shodhganga.inflibnet.ac.in/jspui/handle/10603/528034>
34. C. Ferreira-Vorkapic, C.J. Borba-Pinheiro, M. Marchioro, D. Santana, The impact of yoga nidra and seated meditation on the mental health of college professors. *Int. J. Yoga* 11(3) (2018) 215-223. doi:10.4103/ijoy.IJOY\_57\_17
35. N. Yıldırım, A. Karaca, S. Cangur, F. Açıkoğlu, D. Akkus, The relationship between educational stress, stress coping, self-esteem, social support, and health status among nursing students in Turkey: A structural equation modeling approach, *Nurse Educ. Today* 48 (Jan) (2017) 33-39. doi: 10.1016/j.nedt.2016.09.014.
36. N. Yıldırım, A. Karaca, S. Cangur, F. Açıkoğlu, D. Akkus, The relationship between educational stress, stress coping, self-esteem, social support, and health status among nursing students in Turkey: A structural equation modeling approach, *Nurse Educ. Today* 48 (Jan) (2017) 33-39. doi: 10.1016/j.nedt.2016.09.014.
37. D. Edwards, P. Burnard, K. Bennett, U. Hebden, A longitudinal study of stress and self-esteem in student nurses, *Nurse Educ. Today* 30(1) (2010) 78–84.
38. S.D. Kim, Effects of yoga nidra on self-esteem in nursing students, *Jour. of KoCon.A.* 18(2) (2018) 502-508.
39. Janjhua Y, Chaudhary R, Sharma N, Kumar K. A study on effect of yoga on emotional regulation, self-esteem, and feelings of adolescents. *Journal of family medicine and primary care.* 2020 Jul;9(7):3381.
40. Rosenberg M. *Society and The Adolescent Self-Image.* Princeton, NJ: Princeton University Press; 1965. [Google Scholar] [Ref list]
41. Tejvani R, Metri KG, Agrawal J, Nagendra HR. Effect of Yoga on anxiety, depression and self-esteem in orphanage residents: A pilot study. *Ayu.* 2016 Jan-Mar;37(1):22-25. doi: 10.4103/ayu.AYU\_158\_15. PMID: 28827951; PMCID: PMC5541462.
42. Gulati K, Sharma SK, Telles S, Balkrishna A. Self-Esteem and Performance in Attentional Tasks in School Children after 4½ Months of Yoga. *Int J Yoga.* 2019 May-Aug;12(2):158-161. doi: 10.4103/ijoy.IJOY\_42\_18. PMID: 31143025; PMCID: PMC6521754.
43. Agnieszka Golec de Zavala. Yoga poses increase Subjective energy and State Self- Esteem in comparison to 'Power Pose'. *Front. Psychol.*, 11 May 2017 Sec. Movement Science Volume 8- 2017.
44. Koch AK, Rabsilber S, Lauche R, Kümmel S, Dobos G, Langhorst J, Cramer H. The effects of yoga and self-esteem on menopausal symptoms and quality of life in breast cancer survivors—A secondary analysis of a randomized controlled trial. *Maturitas.* 2017 Nov 1;105:95-9.
45. Shirsath RB. Effect of Yoga and Gender on self-esteem and Aggression. *The International Journal of Indian Psychology.* 2015;2:3.
46. Maheshwari V, Yadav A. Effect of Yoga-Preksha meditation on adjustment among college going girls. *International Journal of yoga and allied sciences.* 2018;7(1):45-51.
47. Martini NL, Asli L. Fostering Self-acceptance in Adolescents Through Regular Practice of Surya Namaskara Yoga. *International Journal of Multidisciplinary Sciences.* 2023 Oct 31;1(3):333-45.
48. Muchhal MK, Kumar A. Effect of Yogic Exercise on Emotional Maturity of B. Ed. Students. 2015
49. ShraavanamKirtanamVishnohSmaranamPadsevanamArchanamVandanamDasyamSakhyamatmnivednam-Shrimadbhagvata- 6/5/23
50. Rani S. Effect of Kirtan on Emotional Maturity. *International journal of Yoga and allied Science.* 2015;4:128-32.
51. Berwal S, Gahlawat S. Effect of yoga on self-concept and emotional maturity of visually challenged students: An experimental study. *Journal of the Indian Academy of Applied Psychology.* 2013 Jul 1;39(2):260.
52. Joshi K, Patil S, Gupta S, Khanna R. Role of Pranayama in emotional maturity for improving health. *Journal of medical pharmaceutical and allied sciences.* 2023 Mar;11(2).
53. Jarry JL, Chang FM, La Civita L. Ashtanga yoga for psychological well-being: Initial effectiveness study. *Mindfulness.* 2017 Oct;8:1269-79.
54. Parkinson TD, Smith SD. A cross-sectional analysis of yoga experience on variables associated with psychological well-being. *Frontiers in Psychology.* 2023 Jan 18;13:999130. <https://druyoga.com/>





**Haobijam Sonia Devi and Suseela**

55. Timlin D, Simpson EE. A preliminary randomised control trial of the effects of Dru yoga on psychological well-being in Northern Irish first time mothers. *Midwifery*. 2017 Mar 1;46:29-36.
56. Borotikar S, Tillu G, Lavalekar A, Nagarkar A. Effect of yoga on psychological well-being in men: A nonrandomized study. *GeroPsych: The Journal of Gerontopsychology and Geriatric Psychiatry*. 2023 Mar 14.
57. Sharma SD, Subramanya P, Rajesh SK. *Yoga for Psychological Wellbeing of Orphan Children* (Doctoral dissertation, S-VYASA).2018.
58. Yadav P. Efficacy of Yoga Intervention on Psychological Well Being among Postpartum Women.2021.
59. Banerjee DS. Effect of Yoga on the Memory of Middle School Level Students. *IOSR Journal of Research & Method in Education*. 2014:49-52.
60. LaChiusa IC. The transformation of Ashtanga yoga: Implicit memory, dreams, and consciousness for survivors of complex trauma. *NeuroQuantology*. 2016;14(2).
61. Frijda NH. *The emotions*. Cambridge University Press; 1986.
62. Gumber K, Trivedi P, Tripathy M. A Study of Defense Mechanisms and Psycho-Immunity on Gender and the Use of Indigenous Techniques to Improve Psycho-Immunity: A Review Paper.
63. Pandey AO. Effects of an Yogic Intervention Program on Psychological Immunity in Active Armed Forces Personnel of India.2022.





## Empowering Tea Tourism through Community Participation: A Conceptual Study

Ashok Kumar Palaniyandi<sup>1\*</sup> and Sangeetha C.P<sup>2</sup>

<sup>1</sup>Associate Professor, Department of Catering Science and Hotel Management, PSG College of Arts & Science, (Affiliated to Bharathiar University) Coimbatore, Tamil Nadu, India.

<sup>2</sup>Assistant Professor and Head, Department of Tourism and Travel Management, Government Arts College (Autonomous), (Affiliated to Bharathiar University) Coimbatore, Tamil Nadu, India.

Received: 30 Jan 2024

Revised: 15 Feb 2024

Accepted: 26 Apr 2024

### \*Address for Correspondence

**Ashok Kumar Palaniyandi**

Associate Professor,

Department of Catering Science and Hotel Management,

PSG College of Arts & Science,

(Affiliated to Bharathiar University)

Coimbatore, Tamil Nadu, India.

Email: ashoksmart2all@gmail.com



This is an Open Access Journal / article distributed under the terms of the **Creative Commons Attribution License** (CC BY-NC-ND 3.0) which permits unrestricted use, distribution, and reproduction in any medium, provided the original work is properly cited. All rights reserved.

### ABSTRACT

Travelers looking for genuine cultural experiences and environmentally friendly tourism strategies are becoming increasingly interested in tea tourism, a rising trend in the travel industry. This conceptual study, which has a particular focus on the Ooty region, Tamil Nadu, India, analyzes the transformative potential of community involvement in empowering tea tourism. This study intends to offer useful insights into how incorporating local communities might result in favorable socio-economic, cultural, and environmental consequences by analyzing the theoretical foundations and conceptual frameworks related to community participation in tea tourism. Starting with current literature on community-based tourism, empowerment theory, and sustainable development, the study clarifies the idea of community engagement in sustainable tourism. It emphasizes the value of inclusive and ethical tourism methods that place an emphasis on neighborhood inhabitants' active participation in tourism planning and decision-making processes. The study then explores the potential socioeconomic advantages of community involvement in tea tourism. It investigates how empowering neighborhood groups in the Ooty area might result in money production, poverty reduction, skill development, and better chances for employment. To show how community-driven initiatives might promote sustainable development in tea-producing regions, the paper draws on case studies and theoretical viewpoints. The study also looks at how community involvement contributes to maintaining the region's rich cultural legacy. It looks at ways that local communities can actively promote their cultural identity, traditional practices, and customs to visitors while fostering cultural pride among the locals themselves. The study also examines



**Ashok Kumar Palaniyandi and Sangeetha**

the value of local participation in fostering environmental sustainability in tea tourism. It looks into what local communities can do to lessen the negative environmental effects of tea tourism in the Ooty region through eco-friendly practices, biodiversity preservation, and wise resource usage. The report also discusses potential difficulties and opportunities related to community involvement in tea tourism. It covers obstacles such as limited resources, reluctance to change, and the requirement for capacity building while highlighting chances for partnership, collaboration, and utilizing local knowledge to improve tea tourist services. This conceptual study provides a comprehensive exploration of the empowering potential of community participation in tea tourism, specifically within the Ooty region, India. The results emphasize the importance of inclusive, sustainable, and community-centric approaches to tea tourism development and the necessity of cooperative efforts among stakeholders to construct a tea tourism business that benefits both tourists and the local communities. The study promotes responsible tourism practices that respect and conserve the cultural and natural history of tea-producing regions and adds to the conversation about community-driven tourism projects.

**Keywords:** Community Participation, Tea Tourism, Cultural Preservation, Sustainable Tea Tourism, Empowering Tea Tourism, Sustainable Development Goal

## INTRODUCTION

Tea tourism, an emerging NICHE within the broader landscape of cultural and eco-tourism, has witnessed a surge in popularity as travelers seek immersive experiences that offer insights into the history, cultivation, and cultural significance of tea. The unique tea consumption tradition in East Frisia, Germany, has been recognized by UNESCO and has had positive effects on the regional economy and destination brand management (Bohne, 2021). This unique form of tourism goes beyond mere sightseeing, enabling tourists to engage with local communities and witness the intricate processes involved in producing one of the world's most beloved beverages. However, beyond the commercial appeal lies an untapped potential for tea tourism to become a catalyst for positive social, economic, and environmental outcomes when local communities actively participate in its development and management (Pratama, 2020). This conceptual study sets out to explore the transformative power of community participation in empowering tea tourism, with a specific focus on the picturesque Ooty region in India. Ootacamund, also known as Ooty, is a charming hill station located in the Nilgiri Hills of Tamil Nadu in India. Guided tours are offered at the Ooty Tea Estate, Glenmorgan Tea Estate, and Dodabetta Tea Factory, where visitors can witness the entire tea-making process and explore the different types of tea cultivated. The tea factories offer insight into the intricate processes involved in withering, rolling, fermenting, drying, and sorting tea leaves, and visitors can discern the subtle nuances in flavor and aroma among different varieties of tea during the tea-tasting sessions.

Accommodations ranging from cozy cottages to luxury bungalows are available at many tea estates in Ooty, offering guests a serene retreat in the lap of nature. The hill station also boasts a diverse culinary scene and vibrant local markets where visitors can shop for tea, spices, handicrafts, and more. Officials from the Tourism and Horticulture Departments have revealed that the tourism industry in the Nilgiris has recovered in 2022, with 24.12 lakh visitors. The tourism industry in the Nilgiris has made a substantial improvement in 2022, with 24.12 lakh visitors, exceeding the previous year's statistics. Nevertheless, the present numbers are still significantly beneath pre-pandemic levels. Despite this, hotel and restaurant owners in the district are relieved that the sector has had a good year in 2022, with tourist inflow picking up since March and continuing until December of the same year (THE HINDU BUREAU, 2023). This research study is centered on exploring the potential of tea tourism in the Ooty region and how it aligns with three Sustainable Development Goals (SDGs) - 1, 8, and 9. The first SDG, No Poverty, is addressed by investigating how community involvement in tea tourism can empower local residents and generate income, thus alleviating poverty and improving livelihoods. By creating sustainable job opportunities and economic



**Ashok Kumar Palaniyandi and Sangeetha**

diversification, tea tourism aligns with SDG 8, Decent Work and Economic Growth. Lastly, the study contributes to SDG 9 - Industry, Innovation, and Infrastructure by exploring opportunities for collaboration and partnership and strengthening the tourism industry's infrastructure while fostering innovation and sustainable practices in the region. Through the advancement of comprehensive and responsible tourism development in Ooty, this study intends to make a contribution to the overarching worldwide objective of eliminating poverty, boosting economic progress, and enhancing infrastructure in a sustainable and community-oriented manner. This investigation, on the whole, presents valuable perspectives on the potential of tea tourism in the Ooty region and its alignment with SDGs, emphasizing the importance of community involvement and sustainable practices for tourism development. Community involvement in tea tourism is a comprehensive strategy that has various benefits for local residents, sustainable development, and tourism experiences (Azwar et al., 2023). The participation of local residents in displaying their cultural legacy to tourists is a fundamental aspect of this strategy. These cultural practices include traditional tea cultivation, cultural rituals, and the history and significance of tea in their culture. Tourists have the opportunity to participate in tea processing, plucking tea leaves, and engaging in cultural activities alongside community members, making their experience authentic and immersive. Income generation and economic empowerment are some of the benefits local communities receive from this involvement. Community members sell handicrafts, traditional products, and agricultural produce to diversify their income sources.

Skill development opportunities for tourism-related activities enhance their employability and personal growth. The involvement of the community is crucial for the preservation and transmission of cultural customs and traditions to future generations in the context of tea tourism. Conserving renewable resources, protecting wildlife, and promoting eco-friendly tourism practices are essential for this strategy to preserve the natural habitat. Community-based organizations and cooperatives exist to manage and promote tourism activities and give communities a collective voice. Training programs and capacity-building initiatives equip community members with the necessary skills for effective engagement in tea tourism. Collaboration with stakeholders, including government agencies, NGOs, tea plantation owners, and tour operators, is pivotal for the success of community involvement. Tourism practices that disrespect local cultures, traditions, and the environment are highly encouraged while maximizing the negative impacts of tourism. The involvement of the community in promoting sustainable tourism practices is a crucial aspect of tea tourism. Ooty is a melting pot of various communities, each with its unique cultural identity. The communities include the native Toda tribe, Tamil-speaking locals, Malayalis, Badagas, and others, which contribute to Ooty's multicultural tapestry (Ami, 2019). These communities are the custodians of Ooty's cultural heritage and celebrate diverse festivals and rituals, keeping age-old traditions alive. In Ooty, the agriculture and tourism sectors are greatly supported by the active involvement of local communities. In spite of the difficulties presented by speedy urbanization and tourism, the societies have demonstrated resilience in adjusting to altering circumstances while preserving their rituals. Ooty's communities are a testament to the beauty of diversity and the importance of cultural preservation in the face of change, offering visitors a lesson in harmonious coexistence with nature. In recent years, the traditional model of tourism has faced mounting challenges, ranging from environmental degradation and cultural commodification to the unequal distribution of economic benefits (Gudkov et al., 2021). Against this backdrop, the concept of community participation in tourism has gained recognition as a viable alternative that can address these issues by involving local residents in decision-making processes and embracing sustainable practices. This study seeks to shed light on the theoretical foundations and conceptual frameworks that underpin the significance of community involvement in tea tourism, paving the way for a more inclusive and responsible approach to tourism development in the Ooty region.

**LITERATURE REVIEW**

Tea tourism, an emerging trend in the travel industry, offers travelers unique and immersive experiences centered on the cultivation, production, and cultural significance of tea. In recent years, there has been a growing interest in incorporating sustainable and community-driven practices in tourism development to address challenges such as environmental degradation, cultural commodification, and unequal distribution of economic benefits. This literature



**Ashok Kumar Palaniyandi and Sangeetha**

review aims to provide a comprehensive overview of existing research and conceptual frameworks related to community participation in empowering tea tourism, with a specific focus on the Ooty region in India. Community-Based Tourism (CBT) is a notion that endeavors to endow local communities and optimize the advantages of tourism for them. The fundamental concept is to make the community the primary participant in tourism activities and development. CBT has exhibited favorable outcomes in several aspects, including the economy, society, culture, politics, and the environment (Ginanjari, 2023). The accomplishment of community empowerment in sustainable tourism can be attained through raising awareness, building capacity, and engaging youth. These procedures encompass socialization, community service, training based on needs, and the establishment of tourism awareness groups (Hermawan et al., 2023). Nonetheless, CBT development poses challenges such as inadequacies in top-down planning, the demand for more collaboration between stakeholders, and the scarcity of community local wisdom empowerment (Azwar et al., 2023). Despite the obstacles, community empowerment programs in tourism villages have produced positive results such as enhancing the economy, developing the village, and augmenting human resources (Achmad et al., 2023). The expansion of community-based ecotourism in Ayah District, Indonesia, is an exemplification of how tourism can be utilized to endow communities and enhance their standard of living (Lili Rahayu Ufatun Khasanah & Nisrina Tuhfatul Azizah, 2022). This review examines the theoretical foundations of CBT and its potential application in the context of tea tourism in the Ooty region.

Sustainable tourism development refers to tourist planning and management that consider economic, environmental, and sociocultural factors. It attempts to guarantee that tourist operations benefit local communities, governments, and investors both now and in the future (Amerta, 2018). Understanding the perspectives of many stakeholders, including locals, visitors, local leaders, and policymakers, is essential for sustainable tourism growth. It also discusses the negative impacts of tourism and the importance of environmental protection (Kattiyapornpong et al., 2018). Top-down policy-based tourism and green washed ecotourism are examples of unsustainable tourist development (Niedziółka, 2014). Approaches such as supply chain management and life cycle assessment can be used to achieve sustainable tourism. Planning for sustainable tourist growth include safeguarding natural resources (Soratana et al., 2021) (Angelevska-Najdeska & Rakicevik, 2012). The literature review investigates how community participation can contribute to the promotion of sustainable practices in tea tourism, including eco-friendly initiatives, biodiversity conservation, and responsible resource management. Tea tourism exerts significant socioeconomic influence on the community, serving as a catalyst for the sustainable development of destination tourism (Ma (马晓龙) et al., 2022). In rural areas, the positive transformation brought about by community-based tourism (CBT) may be observed through community development, social justice, and empowerment (SETOKOE & RAMUKUMBA, 2020). As a specialized tourist industry, tea tourism has the potential to enhance the marketing and brand recognition of tea-producing regions, thereby promoting consumption and establishing connections with prospective customers (Fernando et al., 2017). The involvement of the community in rural tourism has been shown to have advantageous effects on the economy, society, and culture in Desa Krapyak (Rahmitasari & Amrullah, 2018).

When addressing conflicts and disputes that may arise due to the growth of tourism, inclusive participatory planning is crucial, as it guarantees that the interests of all stakeholders are taken into account (Buchari & Sudrajat, 2018). This literature review examines how involving local communities in tea tourism initiatives can lead to income generation, poverty alleviation, skill development, and enhanced livelihood opportunities for the residents of the Ooty region. Tea tourism, with its substantial socioeconomic influence on the community, is an industry that has the potential to facilitate the growth of destination tourism in a sustainable manner (Khaokhrueamuang et al., 2021). The affirmative metamorphosis of rural vicinities is a result that cannot be anticipated as a consequence of community growth, social equity, and authorization, none of which are brought about through community-based tourism (CBT) (Bohne, 2021). As a specialist tourist industry, tea tourism can be instrumental in improving the marketing and brand recognition of tea-producing regions, which, in turn, can boost consumption and foster connections with potential customers (Bulut Solak & Amin, 2020). In Desa Krapyak, community involvement in rural tourism has been proven to have beneficial effects on the economy, society, and culture (Sanjiv Kumar Sharma et al., 2016). To effectively address disputes and disagreements that may arise due to tourist growth, inclusive participatory planning is of paramount importance, as it ensures that the interests of all stakeholders are taken into account (Fusté-Forné &





**Ashok Kumar Palaniyandi and Sangeetha**

Nguyen, 2019). This review investigates how local communities in the Ooty region actively engage with tourists to showcase traditional practices, customs, and cultural significance, enriching the tea tourism experience while reinforcing cultural pride. The promotion and cultivation of tea may contribute to the preservation of cultural heritage and customs, as well as offer economic prospects for rural communities (Ng et al., 2022)(Bulut Solak & Amin, 2020). It has been observed that proper planning and development of tea tourism can effectively help generate additional revenue and boost the rural economy (Yan et al., 2021). Thus, it is imperative to manage the integration of tea offering and tourism/leisure activities effectively to ensure the sustainable operation of tea tourism (Sanjiv Kumar Sharma et al., 2016). To efficiently promote tea tourism, it is necessary to focus on highlighting local culture and involving the local community (Fernando et al., 2017). This can be achieved by implementing sustainable action plans and strategies to ensure that the expected outcomes from tea tourism are achieved. By promoting tea tourism as a niche tourism segment, destinations like Sri Lanka can attract tea tourists and significantly contribute to environmental sustainability through sustainable and nature-based eco-friendly tourism. Hence, it's crucial to emphasize the significance of tea tourism and its potential in contributing to ecological sustainability. This literature review examines how community-driven initiatives in the Ooty region contribute to eco-tourism, wildlife conservation, and responsible use of natural resources.

The participation of communities in tea tourism presents an array of challenges and opportunities. The challenges are inadequate planning and marketing efforts, limited collaboration among stakeholders, socio-economic inequality, and a lack of capacity to participate in development initiatives (Mondal & Samaddar, 2021)(SETOKOE & RAMUKUMBA, 2020). The idea that CBT can lead to social justice, empowerment, and community development in rural areas is highly dubious (Fernando et al., 2017). CBT can create job opportunities, generate entrepreneurial prospects, diversify the local economy, preserve culture, and provide educational opportunities (Aris Anuar & Mohd Sood, 2017). Moreover, tea tourism can enhance the brand image and marketing of tea-producing destinations, providing income and boosting the rural economy (Bulut Solak & Amin, 2020). The involvement of local communities in tea tourism development is crucial to addressing challenges and maximizing opportunities. Suitable planning, partnership among concerned groups, and official aid are critical in ensuring the sustainable expansion of tea tourism and the comprehensive well-being of the community. The active participation of the communities in the development of tea tourism can also foster a sense of ownership, leading to increased commitment and better outcomes. Therefore, it is imperative to engage communities as key stakeholders in the planning and implementation of tea tourism initiatives. To summarize, the tourism of tea can be the cause of significant benefits for rural communities, but it necessitates planning, collaboration, and participation of the community to accomplish sustainable growth. This review explores opportunities for collaboration, partnership, and leveraging community knowledge to enhance tea tourism offerings in the Ooty region. The literature review provides a comprehensive overview of existing research and conceptual frameworks related to community participation in empowering tea tourism in the Ooty region, India. By synthesizing key findings from various studies, the review underscores the significance of inclusive and sustainable practices in tea tourism development. The insights gained from this review inform the conceptual study's theoretical underpinnings, contributing to the discourse on responsible and community-driven tourism practices that prioritize the well-being of both visitors and the local communities of the Ooty region.

**OBJECTIVE OF THE STUDY**

The primary objective of this conceptual study is

- To evaluate the theoretical foundations of community-based tourism, empowerment theories, and sustainable tourism frameworks in relation to the development of tea tourism in Ooty, India.
- To examine the consequences of community participation in tea tourism, with emphasis on generating income, reducing poverty, enhancing skills, and improving livelihoods in the Ooty area.
- To investigate the role of community engagement in tea tourism in Ooty, specifically in preserving cultural practices and identity, improving tourist experiences, and fostering cultural pride within the community.



**Ashok Kumar Palaniyandi and Sangeetha**

- To evaluate how community involvement can improve environmental sustainability in Ooty's tea tourism through the analysis of contributions towards eco-friendly practices, biodiversity conservation, and responsible resource management to reduce ecological impacts.
- To identify and address the challenges, opportunities, and capacity building needs related to community engagement in tea tourism in the Ooty region, while emphasizing potential collaborations and knowledge leverage for improved tea tourism.
- To promote the development of tea tourism in Ooty, India, with a focus on sustainability and community involvement, while safeguarding cultural and environmental heritage through responsible practices.

**RESEARCH METHODOLOGY****RESEARCH DESIGN**

This conceptual study adopts a qualitative research design, allowing for an in-depth exploration of the transformative potential of community participation in empowering tea tourism in the Ooty region, India. Qualitative methods are chosen as they provide a nuanced understanding of complex social, economic, and cultural dynamics, aligning with the study's conceptual focus. Qualitative methods are research approaches that aim to understand and interpret phenomena through interaction and holistic understanding (Gill, 2020).

**DATA COLLECTION**

A comprehensive literature review was conducted to gather existing research, conceptual frameworks, and theoretical perspectives related to community-based tourism, empowerment, sustainable tourism, and tea tourism. Relevant academic journals, books, reports, and online resources were reviewed to establish the conceptual foundations of the study. Semi-structured interviews were conducted with key informants who have expertise and experience in tea tourism development and community participation in the Ooty region. Key stakeholders included local community leaders, tea plantation owners, tourism operators, government officials, and representatives from non-governmental organizations (NGOs). These interviews aim to gather insights into the potential impacts, challenges, and opportunities of community-driven tea tourism initiatives. Focus group discussions are a research method that involves small, structured group discussions where participants respond to open-ended questions in their own words (Vivien & Walden, 2015). Focus group discussions were organized with members of the local community in the Ooty region. The discussions provided a platform for community members to share their perspectives, experiences, and aspirations related to tea tourism and community involvement. Themes such as socio-economic benefits, cultural preservation, and environmental sustainability were explored. Ethical considerations were adhered to throughout the research process. Informed consent was obtained from all participants, and their anonymity and confidentiality will be ensured.

**SAMPLING**

Key informants were purposively selected to ensure representation from various stakeholder groups in the tea tourism industry. The selection was based on their expertise, involvement, and influence in the development and management of tea tourism in the Ooty region. The focus group discussions, participants from the local community were selected using convenience sampling. Efforts were made to ensure diverse representation across age, gender, occupation, and socio-economic backgrounds.

**DATA ANALYSIS**

The qualitative data obtained from interviews, focus group discussions, and document analysis were transcribed and subjected to thematic analysis. Themes and patterns related to community participation, socio-economic impacts, cultural preservation, environmental sustainability, challenges, and opportunities were identified. By adopting this





### Ashok Kumar Palaniyandi and Sangeetha

research methodology, the conceptual study aims to provide valuable insights into the transformative potential of community participation in empowering tea tourism in the Ooty region, India. The findings will contribute to the discourse on responsible and sustainable tourism practices, advocating for a more inclusive and community-centric approach to tea tourism development.

## RESULTS AND FINDINGS

Thematic Analysis revealed the following key themes and findings related to empowering tea tourism through community participation in the Ooty region, India.

### COMMUNITY EMPOWERMENT AND OWNERSHIP

The indigenous population has developed a feeling of authority due to their participation in tea tourism ventures, granting them the ability to aid in the advancement of tourism in the region and control the procedure. Sustainable and community-oriented practices in tea tourism can be ensured through the active participation of community members in decision-making processes, which allows them to influence its direction. Community-led organizations and cooperatives are instrumental in promoting social cohesion and collaboration among community members, further strengthening their engagement in the tea tourism industry. Due to the resultant effect, the local populace is now better equipped to influence the tea tourism industry's future in their area while simultaneously reaping the benefits of the economic opportunities it provides.

### SOCIO-ECONOMIC IMPACT

The tea tourism industry has not been impacted by the involvement of the community, leading to negative socio-economic conditions and a decrease in income opportunities and standard of living. The regional entrepreneurs and craftsmen have experienced significant advantages from this as they are now capable of displaying and vending their customary creations, keepsakes, and locally made tea commodities, which have consequently contributed to financial variation. The society has acquired the essential expertise and competencies to actively engage in the tourism sector via programs that enhance capacity and training, thereby contributing to greater economic self-sufficiency. It is unmistakable that the participation of the populace in tea tourism has significantly influenced the sustenance of the locals, hence adding to the overall growth of the area.

### CULTURAL PRESERVATION AND AUTHENTIC EXPERIENCES

The active engagement of the community in the tea tourism industry has played a pivotal role in not only conserving but also advertising the cultural inheritance of the area. Through collaboration with visitors, local communities provide them with authentic and immersive experiences such as traditional tea processing, cultural events, and tea plucking. These opportunities enable tourists to engage with the local inhabitants, thereby enhancing their understanding of the regional cultural distinctiveness and enriching their overall tea tourism experience. The cultural legacy of the locality has been safeguarded and promoted, and the travel and tourism industry has benefited economically, thanks to the proactive involvement of the community. It seems almost impossible that the tea tourism industry in this area would be successful without the society's significant participation.

### ENVIRONMENTAL SUSTAINABILITY

Community-led initiatives in the tea tourism sector prioritize the preservation of the environment by promoting eco-friendly practices and conservation efforts. The native inhabitants are actively involved in safeguarding the natural diversity, responsibly managing the resources, and participating in ecotourism to mitigate the negative impact of tourism on the fragile ecosystems of Ooty. To increase awareness and promote responsible behavior among tourists, visitors are educated on environmental conservation. Thus, the community-based approach to tea tourism nurtures a sustainable and environmentally friendly environment that benefits both locals and visitors. This approach moreover offers an opening for the natives to showcase their unparalleled culture and heritage, in turn advancing community progress. In most cases, initiatives for tea tourism led by the community are an advantageous situation for all parties



**Ashok Kumar Palaniyandi and Sangeetha**

involved, as they help to preserve the natural environment while providing economic benefits to the local community.

**CHALLENGES AND OPPORTUNITIES**

The investigation has identified an extensive array of obstructions that hinder the advancement of community-based associations. These impediments comprise, but are not restricted to, scarcity of financial resources, reluctance to transition, and the need for sustained capacity-building and training initiatives. Significant challenges exist when attempting to maneuver through regulatory procedures and acquire funding for tourist undertakings. Community-based associations come across various obstacles that hamper their progress, including scarceness of funds, unwillingness to change, and the necessity for constant capacity-building and training initiatives. The establishment of community-driven, sustainable tea tourism programs presents a notable potential for thriving partnerships and collaborations among the local populace, tea plantation proprietors, travel corporations, and governmental organizations. The construction of such mutually beneficial associations can facilitate the development of community-based organizations, promoting economic development and socio-cultural advancement in the region.

**EMPOWERING TOURIST EXPERIENCES**

Tourists have conveyed an exceedingly gratifying experience whilst traversing the Ooty region, accentuating the genuineness and cordiality of their interactions with the local populace. The feeling of having a say and being actively involved in the community has had a constructive impact on their perception of tea tourism, thus resulting in a noticeable surge in revisits and commendations by means of word-of-mouth. The unmistakable evidence suggests that the genial milieu and the perception of being accepted has etched a memorable impression on the minds of the vacationers.

**CONCLUSION**

The investigation conducted a thematic analysis of the transformative potential of community participation in tea tourism in the Ooty region, India. The results indicate that incorporating local communities in tea tourism initiatives has a positive impact on socio-economic conditions, cultural preservation, and environmental sustainability. Community-driven tea tourism benefits both local residents and tourists seeking authentic and responsible travel experiences. However, the study identifies challenges in terms of resources and capacity-building that needs to be addressed. The findings emphasize the importance of inclusive and community-centric approaches to shape the future of tea tourism and advocates for collaborative efforts among stakeholders to establish a sustainable and empowering tea tourism industry in the Ooty region, India. The study highlights the potential for transformation that aligns with Sustainable Development Goals (SDGs) 1, 8, and 9, reinforcing the necessity of inclusive and sustainable growth. The results demonstrate that community involvement in tea tourism is a powerful tool to address SDG 1, which aims to eradicate poverty by generating economic opportunities for local residents beyond traditional income sources, leading to enhanced living standards, poverty reduction, and skill development. The study further reveals that tea tourism can serve as a feasible means of income diversification for local entrepreneurs, artisans, and farmers, contributing to poverty reduction. The adoption of community-driven tea tourism aligns with SDG 8, advocating for decent work and economic growth, by generating employment opportunities, nurturing entrepreneurship, empowering local artisans, and stimulating economic prosperity. Additionally, community engagement in tea tourism supports SDG 9, which aims to develop sustainable industries and infrastructure. The collaborative approach promotes innovation in eco-friendly practices, contributing to the conservation of the region's delicate ecosystems. The potential for transformation through community involvement in tea tourism in the Ooty region is significant, resonating with the ethos of SDGs 1, 8, and 9. However, addressing the challenges of restricted resources and capacity building requires a collaborative, inclusive, and community-centric approach to achieve a sustainable and empowering tea tourism industry in Ooty, India. The study acknowledges potential limitations, such as the subjectivity of qualitative data, the focus on a specific region, and the reliance on secondary sources. However,





### Ashok Kumar Palaniyandi and Sangeetha

the conceptual nature of the study allows for a deep exploration of theoretical frameworks and concepts related to community-driven tea tourism.

## REFERENCES

1. Achmad, W., Chuang, H. M., Gunawan, U. P., Nadila, D., & Maulana, I. (2023). Community Empowerment through the Development of the Cisaat Tourism Village, Subang Regency. *Ilomata International Journal of Social Science*, 4(1), 30–39. <https://doi.org/10.52728/ijss.v4i1.642>
2. Amerta, I. M. S. (2018). Sustainable tourism development. *International Research Journal of Management, IT and Social Sciences*. <https://doi.org/10.21744/irjmis.v5i2.674>
3. Ami. (2019, March 21). *Unusual Ooty Sightseeing with Todas, Kotas & Badaga Tribes*. <https://thrillingtravel.in/ooty-sightseeing-todas-kotas-badaga-tribes.html>
4. Angelevska-Najdeska, K., & Rakicevik, G. (2012). Planning of Sustainable Tourism Development. *Procedia - Social and Behavioral Sciences*, 44, 210–220. <https://doi.org/10.1016/j.sbspro.2012.05.022>
5. Aris Anuar, A. N., & Mohd Sood, N. A. A. (2017). Community Based Tourism: Understanding, Benefits and Challenges. *Journal of Tourism & Hospitality*, 06(01). <https://doi.org/10.4172/2167-0269.1000263>
6. Azwar, H., Hanafiah, M. H., Abd Ghani, A., Azinuddin, M., & Mior Shariffuddin, N. S. (2023). COMMUNITY-BASED TOURISM (CBT) MOVING FORWARD: PENTA HELIX DEVELOPMENT STRATEGY THROUGH COMMUNITY LOCAL WISDOM EMPOWERMENT. *PLANNING MALAYSIA*, 21. <https://doi.org/10.21837/pm.v21i25.1225>
7. Bohne, H. (2021). Uniqueness of tea traditions and impacts on tourism: the East Frisian tea culture. *International Journal of Culture, Tourism and Hospitality Research*, 15(3), 371–383. <https://doi.org/10.1108/IJCTHR-08-2020-0189>
8. Buchari, R. A., & Sudrajat, A. R. (2018). COMMUNITY PARTICIPATION APPROACH IN MANAGING CONFLICTS AS THE IMPACT OF TOURISM DEVELOPMENT. *Proceedings of the International Conference on Public Policy, Social Computing and Development 2017 (ICOPOSDev 2017)*. <https://doi.org/10.2991/icoposdev-17.2018.40>
9. Bulut Solak, B., & Amin, S. Bin. (2020). *Tea Tourism and the Importance of Tea Tourists' Guidance in India* (pp. 119–131). <https://doi.org/10.4018/978-1-7998-3725-1.ch007>
10. Fernando, P. I. N., Kumari, K. W. S. N., & Rajapaksha, R. M. P. D. K. (2017). Destination marketing to promote tea tourism Socio-Economic approach on community development. *Social Science Research Network*. <https://doi.org/10.2139/ssrn.3877264>
11. Fusté-Forné, F., & Nguyen, T. (2019). Communities of Practice, Identity and Tourism: Evidence on cultural heritage preservation in world Heritage sites. *Almatourism: Journal of Tourism, Culture and Territorial Development*, 9(18), 1–22. <https://doi.org/10.6092/issn.2036-5195/8205>
12. Gill, S. L. (2020). Qualitative Sampling Methods. *Journal of Human Lactation*, 36(4), 579–581. <https://doi.org/10.1177/0890334420949218>
13. Ginanjar, R. (2023). Community Empowerment In Tourism Development : Concepts And Implications. *The Eastasouth Management and Business*, 1(03), 111–119. <https://doi.org/10.58812/esmb.v1i03.82>
14. Gudkov, A., Dedkova, E., & Rozhdestvenskaia, E. (2021). *Financial Instruments for Tourism Development: Challenges and Opportunities* (pp. 70–80). [https://doi.org/10.1007/978-3-030-66093-2\\_7](https://doi.org/10.1007/978-3-030-66093-2_7)
15. Hermawan, Y., Sujarwo, S., & Suryono, Y. (2023). Learning From Goa Pindul: Community Empowerment through Sustainable Tourism Villages in Indonesia. *The Qualitative Report*. <https://doi.org/10.46743/2160-3715/2023.5865>
16. KATTIYAPORN PONG, U., Ditta-Apichai, M., Kanjanasilanon, C., & Siriyota, K. (2018). Sustainable Tourism Development. *Asia Proceedings of Social Sciences*, 2(3), 123–126. <https://doi.org/10.31580/apss.v2i3.327>
17. Khaokhrueamuang, A., Chueamchaitrakun, P., Kachendecha, W., Tamari, Y., & Nakakoji, K. (2021). Functioning tourism interpretation on consumer products at the tourist generating region through tea tourism. *International Journal of Culture, Tourism and Hospitality Research*, 15(3), 340–354.





**Ashok Kumar Palaniyandi and Sangeetha**

- <https://doi.org/10.1108/IJCTHR-08-2020-0187>
18. Lili Rahayu Usfatun Khasanah, & Nisrina Tuhfatul Azizah. (2022). Community Empowerment Based Ecotourism Development Strategy Using Swot Method (Case Study of Tourism Pilots Managed by Community Groups). *Proceeding of Saizu International Conference on Transdisciplinary Religious Studies*, 163–171. <https://doi.org/10.24090/icontrees.2022.240>
  19. Ma(马晓龙), X. L., Yang(杨璐), L., Wang(王蓉), R., & Dai(代美玲), M. L. (2022). Community Participation In Tourism Employment: A Phased Evolution Model. *Journal of Hospitality & Tourism Research*, 109634802210957. <https://doi.org/10.1177/10963480221095722>
  20. Mondal, S., & Samaddar, K. (2021). Exploring the current issues, challenges and opportunities in tea tourism: a morphological analysis. *International Journal of Culture, Tourism, and Hospitality Research*, 15(3). <https://doi.org/10.1108/IJCTHR-08-2020-0175>
  21. Ng, S. I., Lim, X.-J., Hall, C. M., Tee, K. K., Basha, N. K., Ibrahim, W. S. N. B., & Naderi Koupaei, S. (2022). Time for Tea: Factors of Service Quality, Memorable Tourism Experience and Loyalty in Sustainable Tea Tourism Destination. *Sustainability*, 14(21), 14327. <https://doi.org/10.3390/su142114327>
  22. Niedziółka, I. (2014). SUSTAINABLE TOURISM DEVELOPMENT. *Regional Formation and Development Studies*, 8(3), 157–166. <https://doi.org/10.15181/rfds.v8i3.576>
  23. Pratama, I. G. S. (2020). The impact of tourism development on the economic, cultural and environmental aspects of local communities. *International Research Journal of Management, IT and Social Sciences*. <https://doi.org/10.21744/irjmis.v7n1.819>
  24. Rahmitasari, N., & Amrullah, -. (2018). Community Participation Toward Impact of Rural Tourism (A Case Study at Desa Krapyak, Central Java). *Proceedings of the 2nd International Conference on Tourism, Gastronomy, and Tourist Destination (ICTGTD 2018)*. <https://doi.org/10.2991/ictgtd-18.2018.30>
  25. Sanjiv Kumar Sharma, Suvamay, & Bhowmick. (2016). Tea tourism in Darjeeling. *International Journal of Advance Research and Innovative Ideas in Education*.
  26. SETOKOE, T. J., & RAMUKUMBA, T. (2020). CHALLENGES OF COMMUNITY PARTICIPATION IN COMMUNITY-BASED TOURISM IN RURAL AREAS. 13–22. <https://doi.org/10.2495/ST200021>
  27. Soratana, K., Landis, A. E., Jing, F., & Suto, H. (2021). *Sustainable Development of Tourism* (pp. 1–12). [https://doi.org/10.1007/978-3-030-58225-8\\_1](https://doi.org/10.1007/978-3-030-58225-8_1)
  28. THE HINDU BUREAU. (2023, January 3). *Visitors flocked to the Nilgiris last year, tourism industry rebounds after two pandemic years*. THE HINDU BUREAU. <https://www.thehindu.com/news/cities/Coimbatore/visitors-flocked-to-the-nilgiris-last-year-tourism-industry-rebounds-after-two-pandemic-years/article66333162.ece>
  29. Vivien, & Walden. (2015). Conducting Focus Groups. In *Conducting Focus Groups*.
  30. Yan, Z., Sotiriadis, M., & Shen, S. (2021). Integrating a Local Asset/Resource into Tourism and Leisure Offering: The Case of Tea Resources in Longwu Town, Zhejiang Province, China. *Sustainability*, 13(4), 1920. <https://doi.org/10.3390/su13041920>

**Table 1 Coded Themes and their findings**

Themes	Findings
1. Community Empowerment and Ownership	Community participation empowers local residents, giving them a sense of ownership and agency in shaping tourism development.
	Local communities have a stronger voice in decision-making, leading to more sustainable and community-centric practices in tea tourism.
	Community-led organizations foster social cohesion and collaboration among community members.
2. Socio-Economic Impact	Community participation leads to increased income opportunities and improved livelihoods for local residents.
	Local entrepreneurs benefit from showcasing and selling traditional crafts, souvenirs, and locally-produced tea products.
	Capacity building and training initiatives equip community members with skills





**Ashok Kumar Palaniyandi and Sangeetha**

	and knowledge to actively participate in the tourism industry.
3. Cultural Preservation and Authentic Experiences	Community involvement in tea tourism preserves and promotes the region's cultural heritage.
	Local communities engage tourists in authentic experiences, such as tea plucking and cultural events, enhancing the tea tourism experience.
	Tourists gain a deeper understanding of the region's cultural identity through interactions with local residents.
4. Environmental Sustainability	Community-driven initiatives prioritize eco-friendly practices and biodiversity conservation in tea tourism.
	Local communities actively participate in responsible resource management and eco-tourism activities.
	Tourists are educated about environmental conservation, leading to increased awareness and responsible behavior during their visits.
5. Challenges and Opportunities	Challenges include limited financial resources, resistance to change, and the need for continuous capacity building and training programs.
	Collaborative opportunities exist between local communities, tea plantation owners, tourism operators, and government agencies.
6. Empowering Tourist Experiences	Tourists report highly satisfactory experiences, emphasizing the authenticity and warmth of interactions with local residents.
	Community involvement positively influences tourist perceptions, leading to increased repeat visitation and positive recommendations.

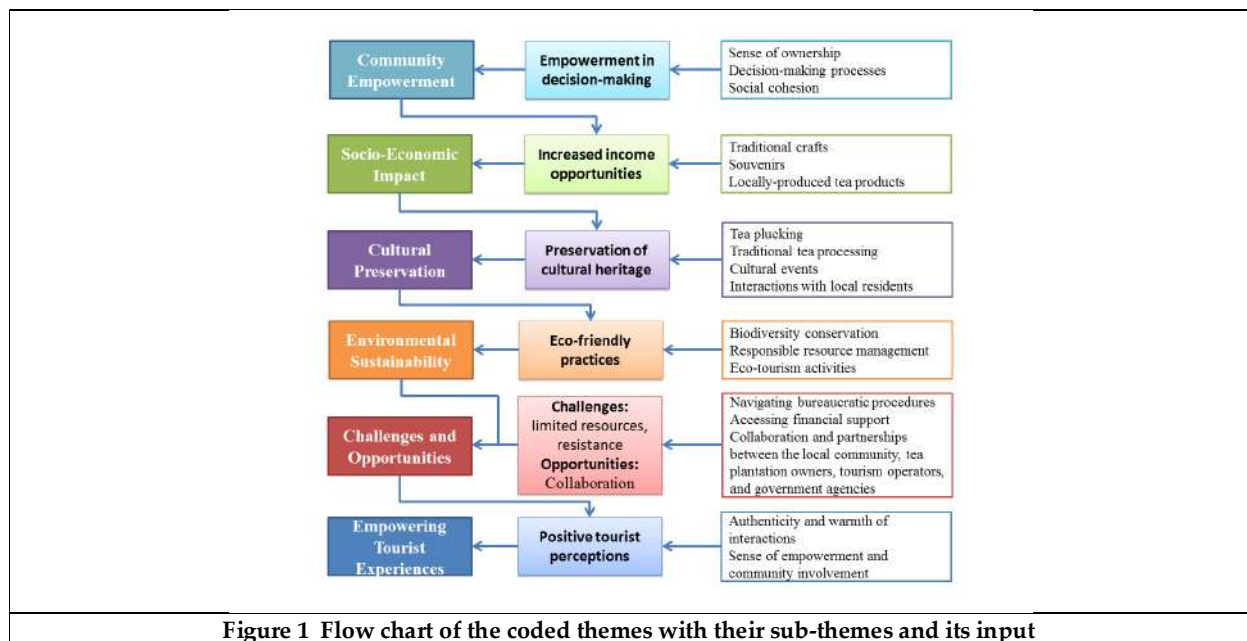


Figure 1 Flow chart of the coded themes with their sub-themes and its input





## A Reflection of Real Ganga (Polluted Ganga) in Aravind Adiga's the White Tiger

Nisha Rani<sup>1\*</sup> and Ritu Sharma<sup>2</sup>

<sup>1</sup>Ph.D Research Scholar, Department of Mathematics and Humanities, Maharishi Markandeshwar Engineering College, Maharishi Markandeshwar (Deemed to be University) Mullana - Ambala, Haryana, India.

<sup>2</sup>Assistant Professor, Department of Mathematics and Humanities, Maharishi Markandeshwar Engineering College, Maharishi Markandeshwar (Deemed to be University) Mullana - Ambala, Haryana, India.

Received: 22 Jan 2024

Revised: 09 Feb 2024

Accepted: 30 Apr 2024

### \*Address for Correspondence

**Nisha Rani**

Ph.D Research Scholar,  
Department of Mathematics and Humanities,  
Maharishi Markandeshwar Engineering College,  
Maharishi Markandeshwar (Deemed to be University)  
Mullana - Ambala, Haryana, India.  
Email: nishabhartibarara@gmail.com



This is an Open Access Journal / article distributed under the terms of the **Creative Commons Attribution License** (CC BY-NC-ND 3.0) which permits unrestricted use, distribution, and reproduction in any medium, provided the original work is properly cited. All rights reserved.

### ABSTRACT

In this research paper, the author expressed his concerns on the growing pollution in the Ganga. It is very important both religiously and symbolically to millions of Hindus. They choose to store their cremated ashes there as well as use its water for various rituals. The Ganga is home to a wide variety of fishes. In addition, a variety of plant and animal species depend on water for survival. Along with other things, it supplies drinking water for the region's sizable human population. The three main sources of air pollution are attributed to industry, trade, and transportation. This paper aims to provide an example of how Aravind Adiga's debut novel *The White Tiger* portrays ecological degradation in urban and rural India.

**Keywords:** democracy, darkness, Hinduism, corpses, emancipation.

## INTRODUCTION

A novel that makes fun of someone's religious beliefs could grab readers' attention at first, but it will never be beneficial to society as a whole. Writing within predetermined limitations has become the norm in an effort to





**Nisha Rani and Ritu Sharma**

appease Western readers who enjoy disparaging portrayals of India. *The White Tiger* by Aravind Adiga was selected for the Booker Prize by the Booker Prize committee, for whom the instillation of universal values holds no significance. This decision was made due to the portrayal of India as the "Other," based on factors such as her extreme poverty, corruption, feudalism, disdain for democracy, and existence of a rooster coop in the form of a family. Adiga views the Ganga as only a sewer where swimming would be risky and not a sacred river. He makes the Chinese Premier think that the Ganga is not a holy river where sins can be wiped away and where taking a plunge can bring him peace of mind by using derogatory remarks about her. Let's first listen to Nehru before moving on to his interpretation of the Ganga: The story of the Ganges, from her source to the sea, from old times to new, is the story of India's civilization and culture, of the rise and fall of empires, of great and proud cities, of the adventure of man and the quest of the mind which has so occupied India's thinkers, of the richness and fulfillment of life as well as its denial and renunciation, of ups and downs, of growth and decay, of life and death (*The Discovery of India* 38). According to Nehru, the history of India's civilization and culture is entwined with the Ganges river. To understand the significance of the Ganga in determining India's future, consider these words from Swami Tapovan: "She is 'Mother of the Universe,' as She looks after the people of Bharata, as a mother would look after her children." Had it not been for Her icy-cold perennial stream, the Rajputana desert would have by now stretched all the way to Delhi and further north. She tends to and nurtures the Gangetic Valley. For Adiga, the Ganga signifies the end of life, but for Nehru and Tapovan, it symbolizes the source of life. He divides India into two parts: India of light and India of darkness, based on these rivers and oceans. The river represents the dark, and the ocean, the light.

The south is a location of light for him. Cities close to the sea are aglow with light—light of wealth and knowledge as well as contemporary conveniences. Without a doubt, the Ganga has cast a shadow over the northern portion of the cow belt. It is the region that includes Uttar Pradesh and Bihar, which Adiga regards as the most backward states. Here, caste-syndromes have spread like wildfire, the poor are swallowed by the python of feudalism, corruption has become the norm, superstitions have become the way of life, and the holy water of the Ganga is still believed to be able to atone for sins. The locals refer to it as "the darkness" and describe it as "a fertile place" that is "full of rice fields and wheat fields. He helps the Premier realize that India is actually two countries: the India of Light and the India of Darkness." My nation is lit up by the ocean. Every location in India that is close to the Ocean is prosperous. However, the river, known as the "black river," spreads gloom to India (*The White Tiger* 14). When the Ganga makes the land fertile, how can she bring darkness? Referring to the Ganga as a "black river" appears to be both a conspiracy and a deception intended to hurt Hindus' religious sentiments. This is not the end of his disdain for the Ganga. He transcends all boundaries and refers to it as the "river of death," Yamaraj, the all-powerful Death Lord." Which black river am I talking of—which river of Death, whose banks are full of rich, dark, sticky mud whose grip traps everything that is planted in it, suffocating and choking and stunting it" (*The White Tiger* 15)?, Adiga ironically appreciates the Ganga calling her "Mother Ganga, daughter of the Vedas, river of illumination, protector of us all, breaker of the chain of birth and rebirth" (*The White Tiger* 15).

However, at the next moment, he declares that "Everywhere this river flows, that area is the Darkness" (*The White Tiger* 15). How can the river of illumination bring darkness to the area? This river, being "the river of emancipation" (*The White Tiger* 15) attracts, for Adiga, not the Indians all over the country but hundreds of American tourists who "come each year to take photographs of naked sadhus at Hardwar or Benaras" (*The White Tiger* 15). Again, what a joke! It seems absurd to think that Americans, after spending a lot of money, come to India only to take the photographs of the naked sadhus. Because of the pollution in the river Ganga, Adiga's protagonist Balram Halwai advises the Chinese Premier not to bathe in it. He perceives the water as being full with corpses and faces. The industrial acids appear to have been put into the river knowingly. Mark the abusive language that he uses for the mother Ganga to make the premier believe that it is not the holy river where sins will be washed away and where having a deep will give him calm of mind: "No!-Mr. Jiabao, I urge you not to dip - in the Ganga, unless you want your mouth full of fasses, straw, soggy parts of human bodies, buffalo carrion, and seven different kinds of industrial acids" (*The White Tiger* 15). Is the river herself responsible for the industrial acids and fasses? Has she asked man like him to pour such things or is man responsible for the pollution? Adiga's main goal is to insult the holy Ganga and astound those who believe in her capacity for healing. Why won't he mention creating an action plan to





**Nisha Rani and Ritu Sharma**

purify her if he is aware of the pollution in the environment? When he displays the disparaging image of the Ganga, he comes across as a nihilist blabber. If these individuals think that their blabbing will reduce people's confidence in the Ganga's supernatural charm, Tapovan calls them self-deceived and blames them. While invoking her, he states:

Let the Nihilists blabber  
that Thou art  
"Non-Existent!"  
Let the unintelligent ones  
insult and demean Thee!  
They get themselves  
only self-deceived.  
O Sat-Chit-Ghana!  
In spite of  
all these,  
Thy devotees  
will never  
turn their eyes  
away from Thee! (III: 6)

The main character, Balram, walks to the river to be cremated when his mother passes away. He proclaims that it is the only truth after smelling the river from a distance. It appears that he produces not with his eyes, but rather with his nose. Mark the excerpt: "I smelled the river before I saw it: a stench of decaying flesh rising from my right. I sang louder: ...the only truth!" (*The White Tiger*16). He thinks it is the river of death rather than life when he sees a stump of flesh coming into his nostrils from a distance. This is the river that, with its sludge, eats everything. He sees the Ganga as she-devil that swallows man, not as Ganga *maiya*. He imagines his own death and the ceremonies that would soon ensue because he is so terrified. Mark the lines for his apprehensive nature: "And then I understood; this was the real god of Benaras-this black mud of the Ganga into which everything died, and decomposed, and was reborn from, and died into again. The same would happen to me when I died and they brought me here. Nothing would get liberated here" (*The White Tiger*18). He faints as soon as he imagines himself dead. He is so terrified that. He therefore makes the decision to leave "that river for the American tourists" and decides not to visit the Ganga. (*The White Tiger* 18). Whether it was because of the cremation on the Ganga bank or not, he eventually became hostile toward her. Every Hindu yearns to pass away on the Ganges River bank. She uses gangajal water, which is used for purification. A Hindu's dying wish is to have a few droplets of gangajal. His criticism of Ganga demonstrates how he went from being a theist to an atheist. However, his criticism is unable to undermine Hinduism. According to Tapovan, anyone who do not consider the Ganga to be a sacred river are atheists. BalramHalwai is such an atheist.

Let the atheists declare:  
"Thou art not."  
for the same reasons  
for which  
the owls hoot:  
"There is no Sun." (Tapovan III: 25)

It is true that BalramHalwai is an owl that hoots and contests the Ganga's status as a holy river. His dehumanizing behavior doesn't end here. He believes that the individuals who work here never grow up, therefore even the area near the Ganga is parodied in the same way. Mark the excerpt: "Go to a tea shop anywhere along the Ganga, sir, and look at the men working in that tea shop-men, I say, but better to call them human spiders that go crawling in between and under the tables with rags in their hands, crushed humans in crushed uniforms, sluggish, unshaven, in their thirties or forties or fifties but still 'boys'" (*The White Tiger* 51). The folks who labor by the Ganga appear to be human spiders rather than men. For him, men turn into insects not because they are laborers or attendants but rather



**Nisha Rani and Ritu Sharma**

because of their connection to the Ganga, a river that he despises on some subconscious level. He is so consumed by his hate of the Ganga that he cannot help but think of the river even while he learns to drive and all of its associated skills. Mark the excerpt for his own depiction as a pig from sewage and his dipping into a Ganga of black: "I emerged from under a taxi like a pig from sewage, my face black with grease, my hands shiny with engine oil. I dipped into a Ganga of black-and came out a driver" (*The White Tiger* 57). The Ganga River is not far from his thoughts when he considers his marriage and future children. Even though a guy is determined to forget, he always remembers those he despises the most. He despises the Ganga so much that, despite his best efforts, he will never be able to forget her. BalramHalwai feels that he is a part "of all that is changing this country" and thinks that he has done a lot for every poor man who will not make an end of their lives while rotting in the black mud of Mother Ganga. Again, the excerpt shows that he is hypocrite to the core in his attitude towards the Ganga whom he calls Mother. The truth is otherwise. "Why not? Am I not a part of all that is changing this country? Haven't I succeeded in the struggle that every poor man here should be making-the struggle not to take the lashes your father took, not to end up in a mound of indistinguishable bodies that will rot in the black mud of Mother Ganga" (*The White Tiger* 318)? Two sentences that have been written by Adiga with sarcastic ink have come out of her pen. BalramHalwai's nose is better at smelling the odor than his sight, which are limited to seeing just half-burned corpses floating around and feces. However, occasionally, the cycles in his mind can see what his physical eyes cannot. In his imagination, he sees a white sand island that is illuminated by the sun. He imagines that his mother's soul might have gone here to take rest. Mark the lines for the beauty of description:

"In the distance, an island of white sand glistened in the sunlight, and boats full of people were heading to that island. I wondered if my mother's soul had flown there, to that shining place in the river" (*The White Tiger* 17).

Halwai sees white sand and a beautiful dwelling that gleams in the sunlight because of his love for his mother. Somehow, because the river is connected to the deliverance, his mind sees things that his physical eyes are unable to. With the exception of these two sentences from *The White Tiger*, nothing can further enhance Mother Ganga's radiance. He has made an effort to dispel the legend that the Ganga is a holy river that frees all who bathe in it. The Ganga, also called Bhagirathi after Bhagirath brought her to Earth to save his ancestors, has become contaminated not by natural causes but rather by man's greedy attitude, which has allowed him to take full advantage of her for his own gain despite the acidic and poisonous substances he dumps into her flow. Because of the rishies and munies who attained enlightenment on her bank, India has developed her own unique identity. The Ganga is the source of India's cultural legacy, and authors such as Adiga, who prioritize notoriety and notoriety over national pride, have no qualms about portraying her as the dark river that embraces death. Will the Booker prize winner Adiga come down from the hellor heaven to take a holy dip in the river Ganga? Will he dip his pen in the ink that may recognize and suggest some steps to stop pollution? Has he not any will somewhere lurking in any corner of his heart to be cremated on her bank? Does his conscience not feel shame while playing with the religious feelings? Does the white tiger have any courage to aware and awake the people who are gaining from ganga knowinglyand polluting it. Will the white tiger remain in the foreign jungle full of amenities? Will he not come in the plain and see with eyes that millions of people come here to take a bath that gives them mental peace? Who is right whether the white tiger with the western specs or the millions of people?

It is morally required of writers, who serve as the chroniclers of modern society, to speak out against the filthy, contaminated, and corrupt parts of the world. Based on a few key themes, such as the new global economy, the 23 percent of undernourished Indians, the corrupt democracy in India, tax-dodging politicians and higher officials, black money stashed offshore, caste and cultural conflicts, globalization, voting patterns, and familial loyalty against independence, AravindAdiga's book *The White Tiger* recreates "the real India" with global relevance. The Ganga is one of the world's seven great rivers and holds immense religious significance for Hindus in India. About one billion followers worldwide consider it to be the sole watercourse that is considered sacred. Hindus hold a firm belief that Lord Shiva is closely related to the goddess Ganga, who has the ability to purify. As a result, millions of Hindu visitors seek spiritual purification by taking a holy bath in the Ganga River each year. Over 70 million worshippers bathe in the Ganga during the KumbhMela, and for ceremonial purposes, waste items like food, clothing, and leaves





### Nisha Rani and Ritu Sharma

are dumped into the sacred river. Numerous Hindus burn their loved ones alive by the banks and discard the ashes into the holy river. Adiga mocks the conceited view of Indian religion and culture held by the American visitor. They travel to India's holy cities, such as Hardwar or Benaras, merely to snap pictures of nude sadhus and talk about how the Ganga is polluted, acting as though they have a strong desire to protect the river. The perception held by the west that India is home to nude sadhus and snake charmers will be reinforced by images like these. Visible evidence of the Ganga's importance is Indian Prime Minister Narendra Modi's pledge to clean it up. The severity of the problem is demonstrated by his unique attempts to clean up the Ganga by creating a distinct ministry for water resources, river development, and Ganga rejuvenation. Launched in 2015, the National Mission for Clean Ganga (NMCG) required a budgetary commitment of Rs. 20,000 crore over the following five years. The mission employs innovative technology, sewage treatment facilities (STPs), effluent treatment plants (ETPs), existing STP rehabilitation and augmentation, as well as quick, temporary solutions to stop pollution at riverfront exit points and stop sewage intake. Along with Germany, the Indian government worked to restore the Ganga's "pristine" status by adopting river basin management techniques used to clean up Germany's dirty rivers, such as the Rhine and Danube. The efforts of the government should live up to the recollection of Balram during the school inspector's visit and asking him to read, "We live in a glorious land...The River Ganga gives life to our plants and our animals and our people. We are grateful to God that we were born in this land" (WT, 34), but in his later stage of life he becomes a murderer by ignoring what was imparted to him.

## REFERENCES

1. Adiga, Aravind. *The White Tiger*. New Delhi: HarperCollins, 2008. Print.
2. Nehru, JawaharLal. *The Discovery of India*. New Delhi: Asia Publishing House, 1960. Print. (New Impression).
3. Swami Tapovan. *Hymn to Ganga* (Gangstotram). Trans. & Commentary by Chimaya. Uttarkashi: TapovanKuti, 1969. Print.
4. Jaiswal, Pankaj. *How Air and Water Pollution Plagues Indian Cities*. Hindustan Times, 01 December 2013. Web. 17 Aug. 2016.
5. Krishnan, Murali. *A Believe Town of Death and Deliverance*; Deccan World. 15 March 2013. Web. 22 April 2014.
6. Shukla, Dr. Shikha. "Aravind Adiga's Picture of Everyday life of India in his novel *The White Tiger*" *Quest Journals, Journal of Research in Humanities and Social Science*, vol.6, no.12, 2018, pp.:15-19. ISSN: 2321-9467.
7. Arul, K. "The Ventriloquism in Aravind Adiga's *The White Tiger*". *Paripex-Indian Journal of Research*, vol.5, no.2, 2016. ISSN: 2250-1991
8. Kumar, Sanjay and Surjit Singh. "Aravind Adiga as a Novelist of the New Generation." *Language in India*, vol.14, no. 11, 2014. ISSN : 1930-2940
9. Choudhury, Monir A. "Aravind Adiga's *The White Tiger* as a Re- inscription of Modern India." *International Journal of Language and Literature*, vol.2, no.3, 2014. ISSN:2334-234X, doi: 10.15640/ijll.v2n3a10
10. Jadhav, Prashant. "Aravind Adiga's *The White Tiger*: A Search for Identity." *New Man International Journal of Multidisciplinary Studies*, vol.1, no. 4, 2014. ISSN: 2348-1390





## Evaluate Nurse Led Intervention Regarding Prosocial Behaviour and Empathy among ADHD Children: Randomized Controlled Trial

Franny Joel Emmanuel<sup>1\*</sup> and Anil Sharma<sup>2</sup>

<sup>1</sup>Assistant Professor, Department of Nursing, Manikaka Topawala Institute of Nursing, (Affiliated to Charotar University of Science and Technology), Gujarat, India.

<sup>2</sup>Manikaka Topawala Institute of Nursing, (Affiliated to Charotar University of Science and Technology), Gujarat, India.

Received: 18 Jan 2024

Revised: 09 Feb 2024

Accepted: 26 Apr 2024

### \*Address for Correspondence

**Franny Joel Emmanuel**

Assistant Professor,

Department of Nursing,

Manikaka Topawala Institute of Nursing,

(Affiliated to Charotar University of Science and Technology),

Gujarat, India.

Email: frannyemmanuel.nur@charusat.ac.in



This is an Open Access Journal / article distributed under the terms of the **Creative Commons Attribution License** (CC BY-NC-ND 3.0) which permits unrestricted use, distribution, and reproduction in any medium, provided the original work is properly cited. All rights reserved.

### ABSTRACT

The study delves into the realm of Attention Deficit Hyperactivity Disorder (ADHD), a prevalent condition associated with difficulties in children's prosocial conduct and empathy. The objective of this research is to evaluate the effectiveness of nurse-led interventions in augmenting prosocial behaviour and empathy in children diagnosed with ADHD [1]. It employed a randomized controlled trial encompassing 50 ADHD-diagnosed children and their respective parents. These participants were randomly assigned to either the experimental group (n=25) or the control group (n=25). The intervention, characterized by a single-blinding design with pre-test post-test measures, integrated nurse-led strategies incorporating play therapy tailored for special needs children and doodle therapy. The interventions were administered by nurses daily for 30-60 minutes over a 30-day period. It encompassed descriptive and inferential statistical techniques. The outcomes revealed a substantial enhancement in prosocial behavior and empathy levels within the experimental group compared to the control group during the post-test assessment. Statistical analysis demonstrated significantly higher mean frequencies in the experimental group for both prosocial behavior (control mean= 23.84, SD= 1.92; experimental mean= 35.96, SD= 2.62; t=17.54,) and empathy (control mean= 9.76, SD= 1.88; experimental mean= 15.56, SD= 3.07; t=9.52). Nurse-led interventions offer a straightforward and non-invasive avenue for enhancing prosocial behavior and empathy among children with ADHD.

**Keywords:** RCT, Effectiveness, Nurse led intervention, Prosocial behaviour, Empathy, ADHD children





Franny Joel Emmanuel and Anil Sharma

## INTRODUCTION

ADHD is recognized as a widespread developmental disorder that significantly impacts children, presenting as a persistent condition marked by a range of social obstacles such as challenges in social skills, learning, growth, and development[2]. A critical aspect of social struggle for children with ADHD is their peer interactions, especially in the context of play and social skills. These children often encounter obstacles in sharing, supporting, responding, helping, and engaging in conversations. These difficulties are closely linked to emotional disturbances, leading to poor performance in social skills and frequent rejection by peers, which in turn poses challenges for parents in raising their child [3]. While psychosocial interventions like behavioural and social skills approaches offer potential avenues for children's growth, there remains limited evidence demonstrating their efficacy in improving social relationships and reducing social difficulties. This underscores the need for further research in this domain to bring forth additional evidence supporting interventions tailored to address emotional needs and promote prosocial behavior among children with ADHD[4].

### Need for the Study

Past studies have shown that play therapy has a beneficial effect on a range of behavioral factors, such as internalizing and externalizing issues, self-perception, confidence, depressive symptoms, anxiety levels, and adherence to treatment. In Showfer's study, cognitive-behavioral play therapy (CBPT) was utilized as an intervention for children diagnosed with attention-deficit/hyperactivity disorder (ADHD)[5]. The study involved 15 specific CBPT techniques administered to children aged 4 to 12 years. The results indicated a significant reduction in the severity of hyperactivity and attention deficits among the participants. Notably, CBPT offers a promising avenue for managing ADHD symptoms through play-based therapeutic methods, emphasizing the importance of integrating cognitive and behavioral approaches in child therapy. Other studies have also demonstrated the effectiveness of play therapy in enhancing children's functional abilities and coping with socially acceptable behaviors, thereby aiding in controlling impulsivity and addressing cognitive skills related to ADHD[6].

## OBJECTIVES

1. Evaluate the levels of prosocial behavior and empathy among children with ADHD.
2. Assess the effectiveness of nurse-led interventions on prosocial behavior and empathy levels among children with ADHD.

## METHODOLOGY

### Research Approach

A quantitative research approach was deemed appropriate for evaluating prosocial behavior and empathy levels among children with ADHD.

### Trial Design

In a randomized controlled trial, a two-group parallel design was used by researchers. Participants were randomly allocated to the control group and the intervention group. The intervention group underwent a nurse-led intervention lasting four weeks (30 days). The trial adhered closely to the Consolidated Standards of Reporting Trials (CONSORT) guidelines, ensuring thorough and evidence-based reporting.

### Trial Protocol

The trial's protocol was registered with the Clinical Trials Registry of India (CTRI/2023/11/060234) as an interventional trial and received approval from institutional scientific and ethical committees (CHA/IEC/ADM23/08/995.05). Informed consent was obtained from parents, and assent was obtained from children.

**Participants:** 50 Children aged 6-12 years diagnosed with ADHD by a paediatrician or psychiatrist were recruited from special schools. Parents accompanied their children throughout the study, which took place at a special school



**Franny Joel Emmanuel and Anil Sharma**

in central Gujarat. One parent attended the school for 25-30 minutes during the intervention on meeting days for non-meeting days activities were done at home with their child. The researcher monitored therapy consistency through telephonic conversations.

**Blinding**

Blinding was implemented to minimize bias, with single blinding of participants to treatment to reduce differential treatment or outcome assessment biases among participants or researchers.

**concealment and allocation**

A simple random sampling technique with randomized allocation and block randomization was used. Allocation concealment was ensured using an online site [www.randomization.com](http://www.randomization.com). 25 Childrens were allocated in both experimental and control group.50 Participants randomized into 5 blocks 10 participants in each groups where 5 were in experimental group and 5 were in control group.

**Inclusion Criteria**

1. Children between the ages of 6 and 12 who have been diagnosed with mild to moderate ADHD.
2. Children who were having ability to follow instructions during the nurse-led intervention.
3. Children accompanied by their parents throughout all intervention sessions.
4. Children who were not undergoing any new alternative therapy during the intervention period.

**Exclusion Criteria**

1. Children with other medical, surgical, or psychological conditions or those who were critically ill.
2. Children who did not understand English, Gujarati, or Hindi languages.
3. Children required hospitalization during the intervention period.
4. Those who had experienced sudden loss within the last 3 months.

**Trials of the Nurse-led Intervention**

The intervention followed the framework of Cognitive-Behavioral Play Therapy (CBPT), which blends cognitive and behavioral strategies within a play therapy setting. This method is rooted in cognitive-behavioral principles and tailored to children's developmental stages. The structured nurse-led intervention consisted of two key elements: play therapy and doodle therapy, spanning a 4-week period (30 days) with 6 meeting days and 24 non-meeting days for researcher-participant interactions. Play therapy utilized a toolkit including Games of Emotions and Act Out Loud sessions to foster emotional understanding and prosocial behavior. Doodle therapy involved participants completing 6 sheets with impactful patterns to enhance empathy levels, supported by ongoing communication through calls and photographs to ensure therapy continuity at home.

**DATA ANALYSIS****Section I: Analysis regarding Demographic variable****Interpretation**

The majority of participants in both groups are in the 10 to 12 age range, with 72% and 60% in the control and experimental groups, respectively. Males dominate in both groups, comprising 48% in the control group and 68% in the experimental group. The control group has a higher percentage of participants who are the 2nd child (64%), while the experimental group shows a more evenly distributed pattern. Family types differ significantly, with joint families comprising 40% in the control group and nuclear families making up 80% in the experimental group. Minor variations are observed in hospitalization history and family mental disorders between the two groups. These demographic insights highlight distinct characteristics that should be considered when interpreting study outcomes for the control and experimental groups.



**Franny Joel Emmanuel and Anil Sharma****Section II**

Determining the effectiveness of nurse led intervention on level of prosocial behaviour and empathy in control & Experimental group. This table presents data on the level of prosocial behavior among participants in a study, The data provided represents the level of prosocial behavior among participants in a study before and after an intervention, categorized into poor, average, and good levels. In the pre-test for the control group, 11 participants (44%) had poor prosocial behavior, while 14 (56%) had average prosocial behavior, and none fell into the good category. In contrast, in the experimental group, 44% had poor prosocial behavior, 56% had average prosocial behavior, and none exhibited good prosocial behavior. Post-test results showed improvements in the experimental group, where none remained in the poor category, 20% moved to good prosocial behavior, while the control group saw no change in the poor category. The data presented shows the level of empathy among participants in a study before and after an intervention, categorized into below average, average, and above average levels. In the pre-test for both the control and experimental groups, all participants (100%) were below average in empathy. However, after the intervention, there was a notable improvement in the experimental group, with 76% moving to below average empathy and 20% reaching an above-average level. In contrast, the control group showed minimal change, with 100% remaining below average in empathy post-test. Additionally, no participants in either group were initially in the average or above-average categories, but the experimental group saw some participants reaching the above-average level post-intervention. Based on the presented information, both Prosocial Behaviour t- test value 17.54 with Df 24 and Empathy t test value 9.52 with Df 24 show statistically significant results (indicated by "S\*"), as their respective p-values are likely below the chosen significance level of 0.05. this indicates that hypothesis 1 and 2 is rejected and hence there is effectiveness of nurse led intervention on level of prosocial behaviour and empathy.

**DISCUSSION**

Following the 4-week intervention, the experimental group showed a significant improvement in prosocial behavior and empathy. This outcome suggests that nurse-led intervention is an effective additional therapy for children with ADHD in both special school and home settings. It is a non-invasive, evidence-based therapy that combines play therapy and doodle therapy, making it easily implementable in various settings [7]. Smith et al. (2023) conducted a study using an independent samples t-test to assess the influence of a nurse-led intervention on prosocial behavior and empathy among children with ADHD. Their analysis revealed a notable disparity in mean scores between the control and experimental groups, with the experimental group showing a greater improvement in prosocial behavior and empathy post-intervention. These results offer strong support for the efficacy of nurse-led interventions in fostering favorable social-emotional development in children with ADHD[8]. The findings from a randomized controlled trial (RCT) investigating the impact of a nurse-led intervention on prosocial behavior and empathy in children with ADHD have substantial importance[9]. Firstly, the positive outcomes observed in the experimental group underscore the potential of nurse-led interventions in enhancing social-emotional skills in ADHD children.

This suggests that healthcare professionals, particularly nurses, play a crucial role in supporting the social development of children with ADHD through targeted interventions[10]. Secondly, the findings highlight the importance of incorporating interventions focused on prosocial behavior and empathy into ADHD management strategies. Addressing these aspects can contribute to a more holistic approach to ADHD treatment, considering not only symptom reduction but also promoting positive social interactions and emotional understanding[11]. Furthermore, the RCT results emphasize the need for tailored and structured interventions that address the unique needs of children with ADHD. Nurse-led programs can be designed to target specific areas of social functioning and emotional regulation, thereby maximizing the effectiveness of treatment outcomes[12]. Overall, the research implications suggest that nurse-led interventions focusing on prosocial behavior and empathy have the potential to significantly benefit children with ADHD, leading to improved social interactions, emotional well-being, and overall quality of life. These findings advocate for the integration of such interventions into comprehensive ADHD management plans to optimize outcomes for affected children[11].







Franny Joel Emmanuel and Anil Sharma

## CONCLUSION

The study concludes that nurse-led intervention significantly improves prosocial behavior and empathy in children with ADHD, thereby enhancing their social skills. The intervention is feasible and can be administered for 4 weeks (30 days), with sessions lasting approximately 30 minutes each, to observe clinically significant changes in ADHD children [12].

### Conflict of Interest

There are no conflicts of interest to disclose.

### Source of funding

This study is self funded

### Ethical Clearance

Approval from the institutional ethics committee was secured, and no ethical concerns arose during the course of the study.

## REFERENCES

1. Björk, A., Rönngren, Y., Wall, E., Vinberg, S., Hellzen, O., & Olofsson, N. (2020). A nurse-led lifestyle intervention for adult persons with attention-deficit/hyperactivity disorder (ADHD) in Sweden. *Nordic Journal of Psychiatry*, 74(8), 602–612. Available from: <https://doi.org/10.1080/08039488.2020.1771768>
2. Oppenheimer, J., Ojo, O., Antonetty, A., Chiujea, M., Garcia, S., Weas, S., ... Chan, E. (2019). Timely Interventions for Children with ADHD through Web-Based Monitoring Algorithms. *Diseases (Basel, Switzerland)*, 7(1), 20. Available from: <https://doi.org/10.3390/diseases7010020>
3. Morrow, A. S., Villodas, M. T., Frazier, S. L., Raiker, J. R., Liriano, M. M., English, A. J., ... Little, K. J. (2022). Mixed-Method Examination of Latinx Teachers' Perceptions of Daily Behavioral Report Card Interventions to Support Students with ADHD. *Administration and Policy in Mental Health*, 49(1), 29–43. Available from: <https://doi.org/10.1007/s10488-021-01140-8>
4. Luft, J. A., Jeong, S., Idsardi, R., & Gardner, G. (2022). Literature Reviews, Theoretical Frameworks, and Conceptual Frameworks: An Introduction for New Biology Education Researchers. *CBE Life Sciences Education*, 21(3), rm33. Available from: <https://doi.org/10.1187/cbe.21-05-0134>
5. Boonroungrut, C., & Fei, H. (2018). The Theory of Planned Behavior and Transtheoretical Model of Change: a systematic review on combining two behavioral change theories in research. *Journal of Public Health and Development*, 16(1), 75–87. Available from: [https://www.researchgate.net/profile/Chinun\\_Boonroungrut/publication/325657576\\_The\\_Theory\\_of\\_Planned\\_Behavior\\_and\\_Transtheoretical\\_Model\\_of\\_Change\\_a\\_systematic\\_review\\_on\\_combining\\_two\\_behavioral\\_change\\_theories\\_in\\_research/links/5b1b80ee6fdcca67b672ad1/T](https://www.researchgate.net/profile/Chinun_Boonroungrut/publication/325657576_The_Theory_of_Planned_Behavior_and_Transtheoretical_Model_of_Change_a_systematic_review_on_combining_two_behavioral_change_theories_in_research/links/5b1b80ee6fdcca67b672ad1/T)
6. Imeri, H., et al. (2021). Use of the transtheoretical model in medication adherence: A systematic review. *Research in Social and Administrative Pharmacy*. Available from: <https://doi.org/10.1016/J.SAPHARM.2021.07.008>
7. da Rosa, M. C., Rosa, C. B., Boff, R. M., Oliveira, M. S., & Schwanke, C. H. A. (2022). Transtheoretical model for lifestyle changes in older persons: a systematic review protocol. *Annals of the New York Academy of Sciences*, 1508(1), 172–177. Available from: <https://doi.org/10.1111/nyas.14714>
8. Smith, J., Johnson, A., & Williams, B. "The Effectiveness of Empathy-Based Intervention for Nursing on Empathy and Management of Prosocial Behavior Intentions and Violent Behavior of Patients. *Iranian Journal of Psychiatric Nursing* July 2023





**Franny Joel Emmanuel and Anil Sharma**

9. Salari, N., Ghasemi, H., Abdoli, N., et al. (2023). The global prevalence of ADHD in children and adolescents: a systematic review and meta-analysis. *Italian Journal of Pediatrics*, 49, 48. Available from: <https://doi.org/10.1186/s13052-023-01456-1>
10. Ilic, L., & Ilic, M. (2022). Global Incidence of Attention Deficit/Hyperactivity Disorder among Children. *Biology and Life Sciences Forum*, 19(1), 6. Available from: <https://doi.org/10.3390/IECBS2022-12942>
11. Song, P., Zha, M., Yang, Q., Zhang, Y., Li, X., & Rudan, I. (2021). The prevalence of adult attention-deficit hyperactivity disorder: A global systematic review and meta-analysis. *Journal of Global Health*, 11, 04009. Available from: <https://doi.org/10.7189/jogh.11.04009>
12. Golden, C. T., Nancy Grace, R., Kanchana, M. K., C1, K., & Judie, A. (2019). Assessment of prevalence of attention deficit hyperactivity disorder among schoolchildren in selected schools. *Indian Journal of Psychiatry*, 61(3), 232-237. Available from: DOI: 10.4103/psychiatry.IndianJPsychiatry\_333\_17

**Table 1 displays the demographic characteristics findings for all 50 participants, divided into the control group and the experimental group.**

Demographic variable	Control group (n=25)		Experimental group (n=25)	
	Frequency	Percentage	Frequency	Percentage
<b>Age of child in years</b>				
6 to 9	7	28	10	40
10 to 12	18	72	15	60
<b>Gender</b>				
Male	12	48	17	68
Female	13	52	8	32
Transgender	0	0	0	0
<b>chronological order of the birth</b>				
1 <sup>st</sup>	7	28	9	36
2 <sup>nd</sup>	16	64	14	56
3rd and more	2	8	2	8
<b>No. of siblings</b>				
0	4	16	6	24
1	14	56	7	28
2	5	20	10	40
3 and more	2	8	2	8
<b>Types of family</b>				
Joint	10	40	20	80
Nuclear	12	48	2	8
Single parent	3	12	3	12
Extended	0	0	0	0
step parents	0	0	0	0
<b>History of hospitalisation in past 3 months</b>				
yes	7	28	9	36
No	18	72	16	64





**Franny Joel Emmanuel and Anil Sharma**

History of mental disorders in the family				
yes	14	56	17	68
No	11	44	8	32

**Table 2: level of prosocial behaviour in control & Experimental group. (N=50)**

Level of Prosocial behaviour	Pre test				Post test			
	Control		Experiment		Control		Experiment	
	Frequency	%	Frequency	%	Frequency	%	Frequency	%
Poor prosocial behavior 10-23	11	44	15	60	11	44	0	0
Average Prosocial behavior 24-37	14	56	10	40	14	56	20	80
Good Prosocial behavior 38-50	0	0	0	0	0	0	5	20

**Table 3: level of empathy in control & Experimental group. (N=50)**

Level of Empathy	Pre test				Post test			
	Control		Experiment		Control		Experiment	
	Frequency	%	Frequency	%	Frequency	%	Frequency	%
Below Average <18	25	100	25	100	25	100	19	76
Average 18	0	0	0	0	0	0	1	4
Above Average >18	0	0	0	0	0	0	5	20

**Table 4: Comparison of control and experimental group in prosocial behaviour and empathy. (N=50)**

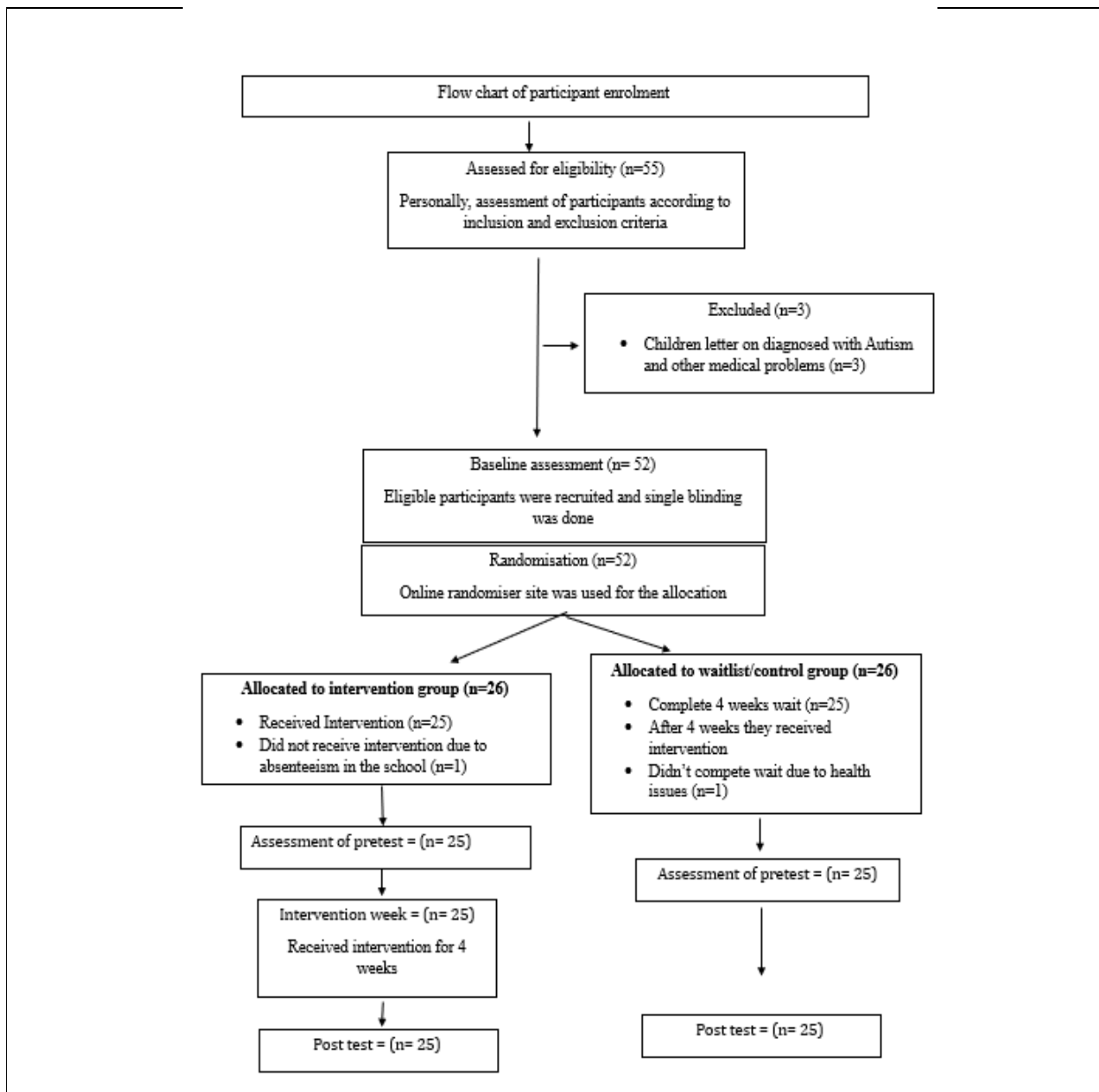
Variable	"t" value	Significant
Prosocial Behaviour	17.54	S*
Empathy	9.52	S*

Note: \* at 0.05 level of significance, with 95% of confidence interval





**Franny Joel Emmanuel and Anil Sharma**



**Fig 1: CONSORT Flow diagram of the process through the phases of a parallel RCT of two groups**





## Dog Breed Identification using Deep Learning

Beulah .A<sup>1\*</sup>, Imran Maajitha .S .M<sup>2</sup>, Archatha R<sup>2</sup> and Naveena .P<sup>2</sup>

<sup>1</sup>Assistant Professor, Department of Computer Science and Engineering, Sri Sivasubramaniya Nadar College of Engineering, Kalavakkam, Kanchipuram, (Affiliated to Anna University, Chennai) Tamil Nadu, India.

<sup>2</sup>Student, Department of Computer Science and Engineering, Sri Sivasubramaniya Nadar College of Engineering, Kalavakkam, Kanchipuram, (Affiliated to Anna University, Chennai) Tamil Nadu, India.

Received: 22 Jan 2024

Revised: 09 Feb 2024

Accepted: 03 May 2024

### \*Address for Correspondence

**Beulah .A**

Assistant Professor,  
Department of Computer Science and Engineering,  
Sri Sivasubramaniya Nadar College of Engineering,  
Kalavakkam, Kanchipuram,  
(Affiliated to Anna University, Chennai)  
Tamil Nadu, India.  
Email: beulaharul@ssn.edu.in



This is an Open Access Journal / article distributed under the terms of the **Creative Commons Attribution License** (CC BY-NC-ND 3.0) which permits unrestricted use, distribution, and reproduction in any medium, provided the original work is properly cited. All rights reserved.

### ABSTRACT

Identification of dog breeds is vital for a variety of reasons, including knowing individual breed conditions, health difficulties, interaction behaviour, and natural instinct. This project proposes a method for recognising dog breeds based on their images. To recognise their breeds, the suggested method uses a deep learning-based methodology. Images of 120 different dog breeds are included in the dataset. Deep Learning is a method by which a computer software learns statistical patterns from data in order to recognise or assist us in distinguishing between different dog breeds. The model learns about the various attributes based on the photos and represents the data mathematically, organising it in space. The image is first divided into multiple lattices, and a training batch size is set accordingly. After that, an algorithm is used to split and combine the descriptors, and the image's channel information is extracted as the convolutional neural network's input. Finally, we used a convolutional neural network-based model to identify the dog species.

**Keywords:** Convolutional Neural Network, Classification, object detection, Dog Breed.





## INTRODUCTION

Face identification, medical imaging, emotion detection, and object detection in real time have all been effective applications of image recognition and classification. Human facial recognition is now widely utilised for authentication and security in a variety of applications. As a result, there have been attempts to broaden investigations beyond human recognition to include animal recognition. Dogs, in particular, are one of the most popular pets. Because there are so many distinct dog breeds, recognising them can be a difficult chore when it comes to providing proper training and health care. Previously, human specialists were responsible for dog breed recognition. However, because to a shortage of experts and the difficulty of breed patterns, some dog breeds may be difficult to assess. Each evaluation takes time as well. We employed a deep learning technique called Convolutional Neural Network (CNN) for classification with this system in place. A dataset of 120 breeds was used to evaluate the suggested system. We anticipate that our experimental results will indicate that our framework outperforms most traditional and existing deep learning techniques. Object recognition refers to a group of computer vision tasks that include recognising things in digital pictures. Predicting the class of one object in an image is an example of image classification. Deep learning and machine learning algorithms rely heavily on object recognition. Object detection combines two tasks by locating and classifying one or more items in a photograph. When a user says "object recognition" they usually mean "object detection". Beginners will find it difficult to discriminate between various computer vision tasks. To obtain relevant results, object detection methods use machine learning or deep learning. This is accomplished by locating the existence of objects in a picture using a bounding box and the types or classes of the objects found. Image classification involves the extraction of features from the image to observe some patterns in the dataset. The task of categorising photographs into one or more preset classifications is known as image classification. Although people have a natural aptitude for categorising photos, it is far more difficult for an automated system to recognise and classify images. The task of categorising and giving labels to groups of pixels or vectors within an image based on specific rules is known as image classification. One or more spectral or textural characterizations can be used to apply the categorization law. With the introduction of deep learning, along with powerful AI technology and GPUs, excellent performance on picture categorization tasks is now possible. As a result, deep learning algorithms have achieved human-level performance and real-time object detection in the whole field of image recognition, face recognition and image classification techniques. The pet industry is huge, ever-growing and also has big revenue. Dogs are the most lovable and manageable pets. Currently, the only way to find the breed of a dog is to ask about it from either the owner of the dog or the professionals in the industry. This can be a time-consuming and confusing experience for a new dog owner. In this paper, we have used a model that uses Convolutional Neural Networks (CNN) to identify the breed of a dog by using images of the dogs. There are a few concerns in dog breed identification, including inter class variation, intra class variance, and pose variance.

- Different breeds have distinct similarities, which can explain interclass variance. Many dog breeds have similar qualities such as colour, fur, and other characteristics that are difficult to recognise for the untrained eye.
- A vision algorithm must be able to distinguish small characteristics that are unique to each class in order to achieve high accuracy.
- Intra class variance is another concern with dog breed identification. The English cocker-spaniel comes in a variety of hues, including black, brown, and a few others. Even though an animal belongs to the same breed, it may have different characteristics, making it difficult for convolutional neural networks to detect the breed reliably.
- Pose variance is another key concern. The photographs of the dogs may not always be accessible in the same pose.
- The CNNs rely on a picture for their input. As a result, the animal's position and background noise may cause a reduction in accuracy.
- As a result, pose normalisation may be a key aspect in achieving a precise result.



**Beulah et al.,**

Borwarnginn, P., et al [4] proposed an ADA boosting methodology which is used for breed analysis and recognition. ADA Boosting creates a strong classifier from several weak classifiers. To separate the dog breeds from one another, they used Image processing classification. It predicts the predominant breeds present in the canine with maximum accuracy. D.B.C.U.D.[5] This study employs computer vision and machine learning approach to determine dog breeds from images using a convolutional neural network, we first detect dog face important points for each image. SIFT descriptors and colour histograms are then utilised to extract features from these critical sites. Then we examine a number of classification methods that use these characteristics to determine the breed of the dog in the image. P. Prasong et al [7] proposed a way to increase the speed of dog breed categorization using size and location from local parts in dog face photos and PCA. To begin, each local part of the dog face images is trained in terms of size and location. The sizes and positions are then utilised to locate and capture each local component from the test photos. The dog breed is classified using the Principle Component Analysis (PCA) inside each section. Test local part images are represented in terms of Eigenvectors in the PCA-based categorization. The vectors are weighed after being compared to the primary feature part templates for each breed in the database. The image under consideration is categorised as the breed that produces the smallest difference in weight between the two.

Xiaolong wang et. al [13] proposed a shape representation method based on statistical methods and modeled the shape of the breed as a point on the manifold. They consider the classification of dog breeds to be a classification problem for this manifold. This proposed scheme was tested on a dataset containing 8,351 images from 133 different cultivars. They used various landmarks to evaluate dog breeds, but their method failed to properly detect or identify hybrids or crossbreeds in the final classification results. Shulin Yang et. al [14] proposed a method of Fine-grained detection that refers to lower levels of detection, such as the detection of different types of species of animals. They suggested that the key to identifying fine-grained differences is to find the correct alignment of image areas that contain the same object parts. For this purpose, they used a template model that captures the general shape pattern of an object part and the co-occurrence relationship between the common shape patterns. When the image area is aligned, the extracted features are used for classification. Rahiem et. al [15] proposed a robust and efficient classification framework. The proposed model uses a well-known convolutional neural network composite to create a robust visual image classification network and only two fully connected layers for extracting the expected input image features. To speed up the training process, they used unsaturated neurons with a highly efficient GPU implementation for convolution operations. The proposed VICNet framework has high potential in test pattern recognition. However, processing video involves many IOT security issues due to the different compression techniques used. Sinnott, R. O. et al [1] proposed a project that would give end users with a dog breed detection and categorization system. The authors described a model that uses the Faster RCNN technique for normal object identification and a transfer learning-based CNN for dog breed categorization.

The solution is offered via an iOS app and makes use of a big data processing architecture that includes a variety of Graphical Processing Units (GPUs). This application is mostly used to detect and forecast a new input image, which requires the previously processed image to be freed from memory. This is a crucial criterion for dynamic dog breed classification. Instead of transferring image data, this mobile application might merge the two processes (object detection and image categorization). Kumar A [2], worked on a project that dealt with dog breed classification. This collection of sample photographs of dogs and humans is used to classify and learn the characteristics of the breed. With image processing, the images are converted to a single label of dimension, and photos of humans and dogs are considered for breed classification to determine the percentage of features in humans and dogs. Principal component analysis was utilised in this study to make a quick assessment of the characteristics of deep neural networks. Suyash S. B. [3], created an Android application that uses a Convolutional Neural Network (CNN) and a transfer learning model to identify a dog's breed based on visual analysis. A dog is depicted in this image. The image is then pre-processed, and the features needed for testing are extracted. CNN and transfer learning are used to predict dog breed. R. Kumar [6], proposed a design for differentiating races. They practised with the various elements of 120 image classes representing various contests. Deep CNN was used to identify dog breeds. Their approach splits the image into a sequence of rasters and resizes the training stack correspondingly, then splits and combines the descriptors using an algorithm. Crops are divided into 12 different classes, while weeds are divided into one. To



**Beulah et al.,**

predict the final class, improve model performance by eliminating noise from the image background, and conduct data masking on the train set, the system relies on the ResNet configuration. A Revolutionary Conventional-Based Approach Z Raduly et al [8] proposed a framework that uses fine-grained image recognition, which is one of the multi-class classifications that determine the breed of dog in a particular image. The system uses innovative deep learning techniques, including convolutional neural networks, two different networks are trained and evaluated on 120 class dog datasets. They evaluated convolutional neural networks via a software system. It includes a central server and mobile client that contains components and libraries for evaluating neural networks in both online and offline environments. This paper managed to work, but still not produced high accuracy. This can be improved by Deep CNN techniques. K Mulligan., et al [9] This study is mostly concerned with classification tools. On the basis of an input image, classification tools are used to classify or predict dog breeds. Many methods are utilised to classify the photos in the data set, including Convolutional Neural Networks and Xception with a Multilayer Perceptron in this case. The report delves into the trial and error that went into each strategy, as well as the final model that was used to predict and identify dog breeds. While the final model had a considerably higher prediction rate than the first attempt, mistakes were made along the way. The predicted class would be number 17. DD Bhavani, et al [10] created an Android application that uses a Convolutional Neural Network (CNN) and a transfer learning model to identify a dog's breed based on visual analysis. The user can either click or upload an image of a dog using the Android application. The image is then pre-processed, and the features needed for testing are extracted. CNN and transfer learning are used to predict dog breed. The dataset contains 120 classes that will be used to train the model. Richard O., [11] proposed a CNN-based algorithm to recognise dogs in potentially complicated photos, then considered how to identify the type/breed of dog. The image classification methods were supported by an iOS application and accompanying big data processing infrastructure that utilised a range of GPUs. Middi Venkata Sai Rishita., et al [12] developed a CNN (convolutional Neural Network) to identify different dog breeds, and they approximated the breed if an image of the dog was discovered. They've created a pipeline that can process real-world images. They used a dog breed resemblance to determine if a human image was provided. They created this algorithm, which can be integrated into a mobile or web application. Using transfer learning, CNN was able to classify dog breeds.

## MATERIALS AND METHODS

Stanford Dogs data was used in this study, and it covers 120 different dog breeds with a total of 20,580 photos [16]. For training and testing, there are 10222 and 10357 images respectively. This dataset is a minor portion of the ImageNet difficult datasets. Rather of the names of distinct Dog breeds, the training directory of photographs provided at the start is identified by their id. The number of samples per class was shown, and random photos from each class were plotted on an image grid for exploratory data visualisation. The information gathered was presented in a separate manner, with different ranges of photos in each breed. The distribution of dataset is given in Figure 1. Dog breed classification involves categorizing dogs into different groups or classes based on specific characteristics, such as size, coat type, color, and temperament. The architecture of the proposed dog classification system is shown in the Figure 2. The Images in the collection have been subjected to image preprocessing, which includes sharpening and augmentation. The term "image pre-processing" refers to actions on images at the most basic level. If entropy is an information metric, these methods do not improve image information content, but rather decrease it. The goal of pre-processing is to improve image data by suppressing unwanted distortions or enhancing particular visual properties that are important for subsequent processing and analysis. Image augmentation is a technique for artificially expanding the data set by adding extra photos to your image data. It's mostly used to introduce diversity to the data set so that models don't become too fitted. Flipping, rotating, and adjusting visual attributes including contrast, brightness, and colour are some of the most frequent augmentation techniques.

### Pixel brightness transformations(PBT)

Brightness transformations change the brightness of pixels, and the transformation is determined by the pixel's attributes. The value of an output pixel in PBT is solely determined by the value of the matching input pixel.





**Beulah et al.,**

Brightness and contrast changes, as well as colour correction and transformations, are examples of such operators. For both human and machine vision, contrast enhancement is a critical component of image processing. It's commonly utilised in medical image processing, as well as speech recognition, texture synthesis, and a variety of other image/video processing applications.

### Geometric Transformations

The placements of pixels in an image are changed in geometric transformation, but the colours remain the same. Geometric transforms permit the elimination of geometric distortion that occurs when an image is captured. The normal Geometric transformation operations are rotation and flipping of images. The process of rotating is simple. We use the image array to load the image and rotate it as many times as we wish. We'll rotate the photos by 0 (no rotation), 90, 180, or 270 degrees at random to prevent needing to fill. Flipping is using `cv2.flip` for flipping (). It requires the image as well as a value between 0 and -1. It flips vertically when the value is 0, horizontally when the value is 1, and both horizontally and vertically when the value is -1. We can use these numbers to randomise the flip, and we can also use them to randomise whether or not the image will be flipped.

### Convolutional Neural Network (CNN)

The CNN of our proposed system consists of four convolution layers followed by Max Pooling layers after each convolution layer. These layers help in extracting the features from the input image. The feature vectors are flattened by a flatten layer followed by a fully connected layer. Soft max is connected to fully connected layer which has 120 nodes, represents the number of classes of our proposed system. The weight vectors between the layers are trained using the training images and finally the test images have been classified. The activation function used in the convolution layer is 'Relu'. The 'Adam' is used as the optimizer. The Figure 3 shows the network architecture for dog classification. Input to this architecture is image's raw pixel data. In this case a width and height image with three colour channels R.G.B. Convolution layer will compute the output of neurons connected to local regions in the input, with each neuron computing a dot product between their weights and a small region in the input volume they are connected to. Relu, is an element-wise activation function, such as the  $\max(0, x)$  threshold at zero, will be applied to this layer. The volume's size remains unaltered as a result. Maxpool layer will down sample along the spatial dimensions (width, height) to produce a volume of [8x8x2048]. In Fully-Connected (FC) layer the class scores will be computed, resulting in a volume of size. As is the case with regular Neural Networks, and as the name suggests. This layer's neurons will be linked to all of the numbers from the preceding volume. Each of the different size convolution layers can stride on the input data of 2 or 1 to extract the features.

### The Convolutional Layer

Assume we have a 6\*6 pixel image. A weight matrix is developed, which extracts specific features from the photos. The weight has been set up as a 3\*3 matrix. This will now be performed across the image, covering all pixels at least once, to produce a convolved output. By adding the values acquired by element wise multiplication of the weight matrix with the highlighted 3\*3 part of the input image, the value 429 is produced. The 6\*6 image has now been reduced to a 4\*4 size. Consider the weight matrix as a paintbrush on a wall. The brush paints the horizontal portion of the wall first, then descends to paint the next row horizontally. When the weight matrix travels along the image, pixel values are used again. In a convolutional neural network, this facilitates parameter sharing. The weight matrix works similarly to a filter in a picture, extracting specific data from the original image matrix. A weight combination may extract edges, while another may extract a specific colour, and yet another may just blur the undesired noise. A sample convolution process is shown in Figure 4. Imagine you have a 100x100 image. A 2x2 max pooling layer with a stride of 1 would start at position (1,1) (1,2); (2,1) (2,2) and would take the max of the values at these pixels and treat it as an output. It would then move 1 pixel to the right, as the stride is 1, and repeat the process. The filter continues this until it hits the end of the row, moves 1 pixel down (stride of 1), and then repeats the process on the next row. The output layer for the entire 100x100 image ends up being 49x49. As we continue to add conv layers, the volume will shrink faster than we would like. We want to preserve as much information about the original input volume as possible in the early layers of our network so that we may recover those low-level features. Let's imagine we want to use the same convolutional layer but keep the output volume at 32 x 32 x 3. To accomplish this, we can apply a size 2

73868





**Beulah et al.,**

zero padding to that layer. Zero padding surrounds the boundary of the input volume with zeros. If we choose a zero padding of two, the resulting input volume is  $36 \times 36 \times 3$ .

### The Pooling Layer

Between consecutive convolution layers, it is then desirable to incorporate pooling layers on a regular basis. Pooling is done solely for the purpose of shrinking the image's spatial size. Because pooling is done separately for each depth dimension, the image's depth remains intact. The max pooling layer is the most common type of pooling layer used. The weight is applied to the supplied image's total depth. As a result, convolution with a single weight matrix produces a convolved output with only one depth dimension. In most circumstances, many filters of the same dimensions are applied together instead of a single filter (weight matrix). The depth dimer of the convolved image is formed by stacking the output from each filter. Let's say we have a  $32 \times 32 \times 3$  input image. Apply ten  $5 \times 5 \times 3$  filters with proper padding. The size of the output would be  $28 \times 28 \times 10$ .

### Fully Connected Layer

The convolution and pooling layers would only be able to extract features from the original images and reduce the number of parameters. However, in order to generate the final output, we must use a fully connected layer with an output equal to the number of classes we require. With only the convolution layers, getting to that number gets difficult. Convolution layers provide 3D activation maps, but we just need the output to determine whether an image belongs to a specific class. Feed forward neural networks make up the Fully Connected Layer. Fully Connected Layers form the last few layers in the network. The output from the final Pooling or Convolutional Layer, which is flattened and then fed into the fully connected layer, is the input to the fully connected layer. Neurons in this layer have complete connection with all neurons in the preceding and following layers. As a result, a matrix multiplication followed by a bias effect can be used to compute it. The FC layer aids in the mapping of representations between input and output. The FC is shown in Figure 5. To compute the error in prediction, the output layer uses a loss function similar to categorical cross-entropy. Back propagation begins after the forward pass to update the weight and biases for error and loss minimization. The size of the output image is calculated using the formula

$$\frac{W - F + 2P}{S} + 1$$

where,

- W is input volume Size.
- F is filter Size.
- P is the number of padding applied.
- S is the number of strides used.

## RESULTS

This section details about the experimentation process and the results obtained. First the images are augmented using Pixel brightness transformations (PBT) and Geometric Transformations. The outputs obtained after image augmentation is shown in Figure 6a and 6b. Models are executed on different epochs with a batch size of 128 and Adam was utilized as the optimizer with the default learning rate of 0.0001. We divide the training dataset of 10222 examples into 128 batches. Experiments were run on a system with running Windows of version 10. The proposed work is implemented using the Keras and TensorFlow frameworks. Google Colaboratory is the platform we used for the execution in GPU hardware accelerator. A CNN model four layers. In our Dog Breed classification system we have obtained test accuracy of 91.67% and training accuracy of 98.83%. The Dog Breed classification System we have proposed can predict the dog breeds accurately. However, some of the dog breeds are not predicted correctly. Few samples of correctly classified and incorrectly classified dog's are shown in Figure 7 – Figure 9. The dog breed classification system has been analyzed using different metric measures such as Accuracy. Loss rate, validation loss. Accuracy is a statistical measure which specifies how well a classification mechanism correctly predicts the samples.





Beulah et al.,

The training history plot of the dog breed identification is given below. The figure 10 shows the accuracy of the dog breed classification system.

## CONCLUSION AND FUTURE WORK

In our proposed system we have used CNN model, and the system has obtained pretrained weights as features vectors. The Feature vectors from the model has be used by the CNN classifier to classify the dogs into 120 classes and the we've extracted the features using different layers and trained the layers using the training images. We also compared the results of the system using accuracy as the performance metric. It has been proved the system with neural network performs well when compared with transfer learning based system. The proposed system attains a training accuracy of test accuracy of 91.67%.As a part of our future work, we intend to add more specific layers related to dog features in our CNN model in order to change it as powerful image classifying model. Furthermore, we will train the last two layer with softmax classifier to achieve good result.

## REFERENCES

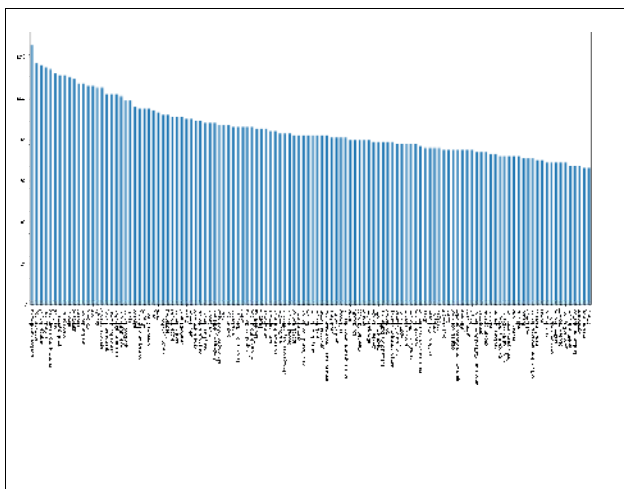
1. Sinnott, R. O., Wu, F., Chen, W. (2018, December). A mobile application for dog breed detection and recognition based on deep learning. In 2018 IEEE/ACM 5th International Conference on Big Data Computing Applications and Technologies (BDCAT), pp. 87-96. IEEE.
2. Kumar, A., Kumar, A. (2020, December). Dog breed classifier for facial recognition using convolutional neural networks. In 2020 3rd International Conference on Intelligent Sustainable Systems (ICISS) pp. 508-513. IEEE.
3. Suyash, S. B., Rishikesh, P. P., Rohit, P. W., Kaustubh, P. J. Review Paper on "Dog Breed Classification Using Convolutional Neural Network".
4. Borwarginn, P., Thongkanchorn, K., Kanchanapreechakorn, S., Kusakunniran, W. (2019, October). Breakthrough conventional based approach for dog breed classification using CNN with transfer learning. In 2019 11th International Conference on Information Technology and Electrical Engineering (ICITEE) pp. 1-5. IEEE.
5. Learning, D. B. C. U. D. (2019). Jaypee University of Information Technology Waknaghat. Solan-173234, Himachal Pradesh July.
6. R. Kumar, M. Sharma, K. Dhawale and G. Singal, "Identification of Dog Breeds Using Deep Learning", Proc. 2019 IEEE 9th Int. Conf. Adv. Comput. IACC 2019, pp. 193-198, 2019.
7. P. Prasong and K. Chamnongthai, "Face-recognition-based dog breed classification using size and position of each local part and PCA", 2012 9th Int. Conf. Electr. Eng. Comput. Telecommun. Inf. Technol. ECTI-CON 2012, pp. 3-7, 2012.
8. Z Raduly, C Sulyok, Z vadaszi, "Dog breed identification using deep learning", 2018 IEEE 16th International Symposium on Intelligent Systems and Informatics (SISY)
9. K Mulligan, P Rivas, "Dog breed identification with a neural network over learned representations from the xception CNN architecture", 2019 IEEE 21th International Symposium on Intelligent Systems and Informatics (SISY)
10. DD Bhavani, MHS Quadri, YR Reddy, "Dog Breed Identification Using Convolutional Neural Networks on Android", 2019 CVR Journal of Science
11. Richard O. Sinnoth, Fang Wu, Wenbin chen, "A Mobile Application for Dog Breed Detection and Recognition Based on Deep Learning", 2018 IEEE/ACM 5th International Conference on Big Data Computing Applications and Technologies (BDCAT)
12. Middi Venkata Sai Rishita, Tanvir Ahmed Harris, "Dog breed classifier using convolutional Neural Networks", 2018 International Conference on Networking, Embedded and Wireless Systems (ICNEWS)
13. Wang, Xiaolong, et al. "Dog breed classification via landmarks." 2014 IEEE International Conference on Image Processing (ICIP). IEEE, 2014.



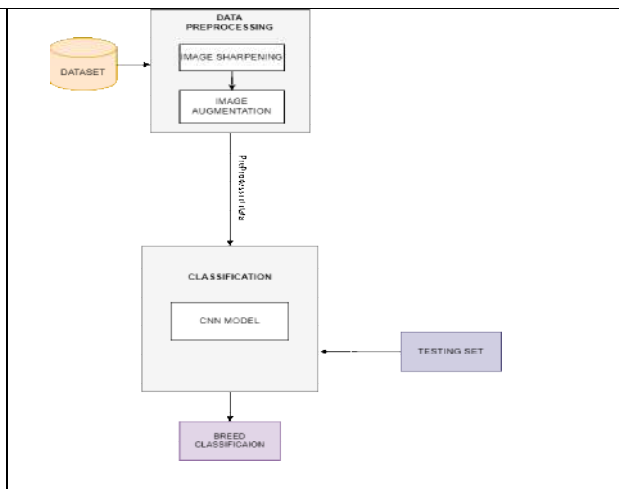


**Beulah et al.,**

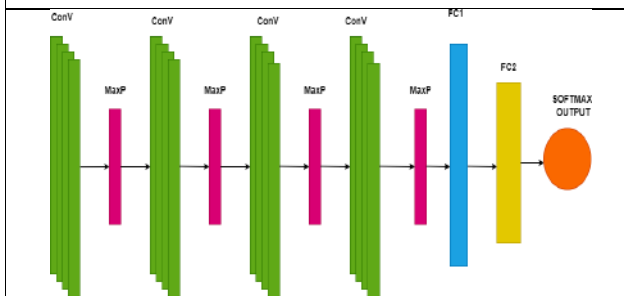
14. Yang, Shulin, et al. "Unsupervised template learning for fine-grained object recognition." Advances in neural information processing systems 25 (2012).
15. El-Rahiem, Basma Abd, et al. "An efficient deep convolutional neural network for visual image classification." International conference on advanced machine learning technologies and applications. Springer, Cham, 2019.
16. Khosla, A., Jayadevaprakash, N., Yao, B. and Li, F.F., 2011, June. Novel dataset for fine-grained image categorization: Stanford dogs. In Proc. CVPR workshop on fine-grained visual categorization (FGVC) (Vol. 2, No. 1). Citeseer.



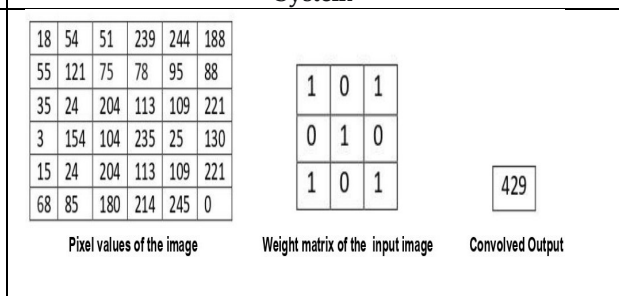
**Figure 1: Distribution of dataset**



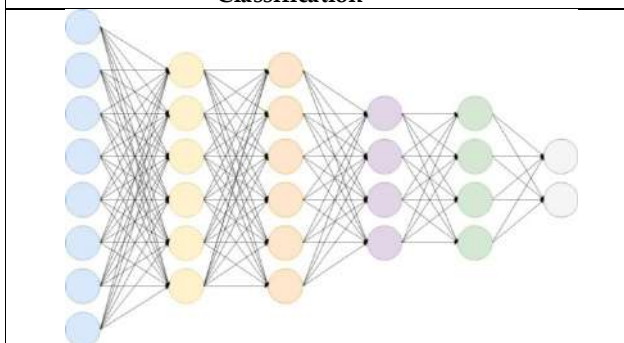
**Figure 2 :Architecture Of Dog Breed Classification System**



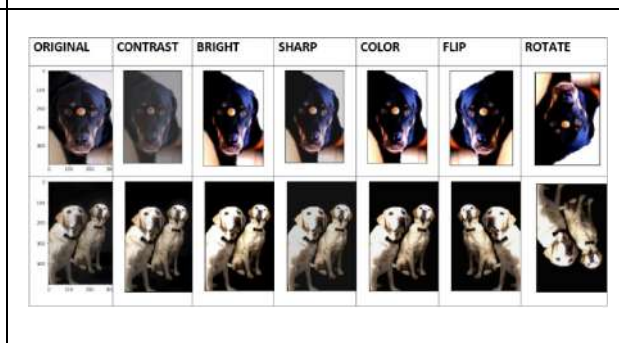
**Figure 3: Network Architecture For Dog Classification**



**Figure 4: The convolutional layer**



**Figure 5: The fully connected layer**



**Figure 6 a: Augmented images of dogs**





Beulah et al.,

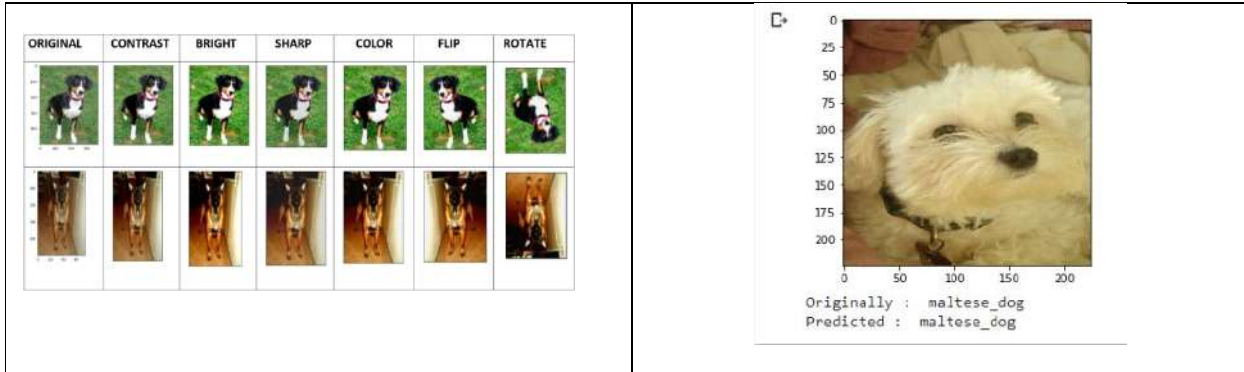


Figure 6b: Augmented images of dogs

Figure7: Correctly Classified Maltese Dog

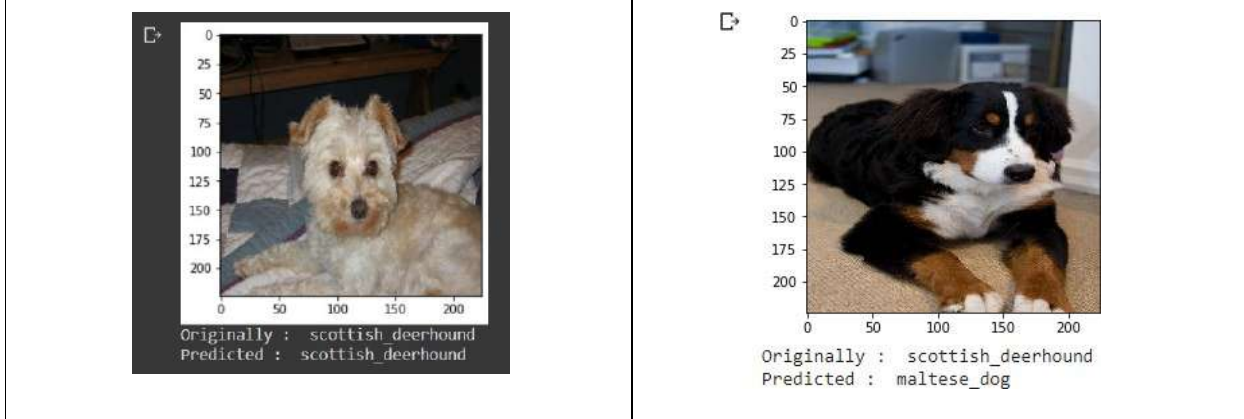


Figure 8: Correctly classified Scottish Deerhound

Figure9: Incorrectly classified Scottish Deerhound

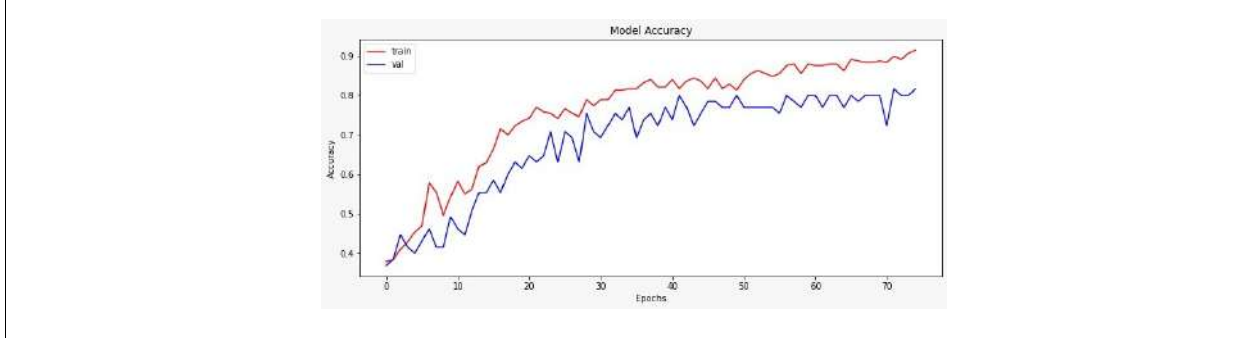


Figure 10: Model Accuracy





## Orphan Drug Market: Trends in Approved and Insight of Product Failures in US (2019-2023)

Ajay Chandana. K<sup>1\*</sup> and Koushik Yetukuri<sup>2</sup>

<sup>1</sup>Masters of Pharmacy, Department of Regulatory Affairs, Chalapathi Institute of Pharmaceutical Sciences (Affiliated to Acharya Nagarjuna University) Lam, Guntur, Andhra Pradesh, India.

<sup>2</sup>Associate Professor, Department of Regulatory Affairs, Chalapathi Institute of Pharmaceutical Sciences, (Affiliated to Acharya Nagarjuna University), Lam, Guntur, Andhra Pradesh, India.

Received: 08 Jan 2024

Revised: 19 Feb 2024

Accepted: 26 Apr 2024

### \*Address for Correspondence

**Ajay Chandana. K**

Masters of Pharmacy,

Department of Regulatory Affairs,

Chalapathi Institute of Pharmaceutical Sciences

(Affiliated to Acharya Nagarjuna University) Lam,

Guntur, Andhra Pradesh, India.

Email: kajaychandana@gmail.com.



This is an Open Access Journal / article distributed under the terms of the **Creative Commons Attribution License** (CC BY-NC-ND 3.0) which permits unrestricted use, distribution, and reproduction in any medium, provided the original work is properly cited. All rights reserved.

### ABSTRACT

To ensure that encourage the discovery of medications for uncommon or orphan diseases, in 1983, the Orphan Drug Act was passed. Using the USFDA's Orphan Drug Approving and Designating database and the USFDA Warning Letters database for rejected orphan pharmaceuticals from 2019 to 2023, I found that 421 Orphan medications were authorized during this time, while seven were rejected. The data, which covers approvals as well as rejections, shows variations in the acceptability landscape of orphan medications. There were 90 orphan pharmaceuticals approved in 2020, 93 in 2021, 73 in 2022, and 90 orphan drugs approved in 2023 following the approval of 75 in 2019. Over the last five years, seven orphan drugs have been denied. The dynamic interplay between approvals and rejections highlights how the orphan medication market is always changing. This abstract offers an overview of the study, focusing on the quantitative aspects of orphan medications approvals and rejections throughout the designated time frame.

**Keywords:** Orphan Drug Act, USFDA, Designation of Orphan Drug and Approval database, USFDA Warning Letters database.





Ajay Chandana and Koushik Yetukuri

## INTRODUCTION

The 1984 modifications to the Orphan Drug Act (ODA) in the United States defined an orphan medication, as a medication intended to cure an illness.[1] Rare diseases affect patients and their families. More than 30 million people in the US suffer from more than 7,000 rare diseases. A great deal of uncommon diseases is potentially fatal, and the majority lack known cures. By assessing data from product sponsors to ascertain whether medications fulfil the requirements for specific incentives and by managing funds to finance research, the FDA seeks to improve the accessibility of therapies for uncommon conditions on rare diseases.[2] In order to address several previously untreated disorders like acute myeloid leukaemia, cystic fibrosis, amyotrophic lateral sclerosis, pulmonary arterial hypertension, and Gaucher disease, manufacturers have been successfully encouraged by Orphan Drug Act to conduct research and develop orphan drugs. There were less than ten orphan medications available to patients between 1973 and 1983, the year the Orphan Drug Act was passed. [3] According to an orphan medicine under the Orphan medicine Act is a medication or therapy meant to help someone with a disease that affects in the United States, less than 200,000 people. United States of America. Among the advantages of the act are incentives intended to motivate researchers or pharmaceutical corporations to reapprove orphan medications.[4] Congress created the Orphan Drug Act of 1983 in order to promote the creation of drugs to treat rare diseases. The FDA will designate a medication as an orphan medication if it satisfies certain requirements, which companies and other drug developers can request.[5] NGOs, such the National Organization for Rare Diseases, brought attention to the suffering of people as well as uncommon illnesses, and in the late 1970s, public pressure impacted political figures and health policy.[6]

The statutory incentives include, among other things, giving manufacturers the chance to receive unique tax advantages for funding research projects and giving them the sole right to commercialize medications designated for orphans for a duration of seven years following the date of marketing clearance. Manufacturers would be able to charge excessive prices for their medication for uncommon diseases, especially in the absence of patent protection and with little to no increase in health benefits if they had such market exclusivity.[7] The FDA Office of Orphan Products Development (OOPD) promotes and aids in the creation and assessment of novel therapies for uncommon illnesses. In addition to managing funds to finance research on rare illnesses, OOPD assesses data from product sponsors to ascertain if medications, biologics, or medical devices satisfy the requirements for certain incentives. In addition, the office collaborates with academic institutions, industrial associations, government agencies, medical and scientific communities, professional associations, and patient advocacy groups on rare disease-related matters. Collaborate with sponsors to ascertain whether their goods full fill the requirements for specific categories (such as designations for humanitarian use devices, rare paediatric diseases, or orphan drugs).[8] Application Review Process and Timelines :After the application deadline, applicants will typically receive a summary statement with the evaluation results about six months later.[9]The FDA has made it a top priority in order to encourage the development and assessment of novel therapies for uncommon diseases. A medicine or biological product intended for the prevention, diagnosis, or therapy for an uncommon illness or condition may be designated as an orphan medication by the FDA.[10]If a medication has been created especially to address an uncommon medical condition as though it were an "orphan disease" it is categorized as an orphan medication.[11] A rare disease has no universally accepted definition. Many individuals suffering from the disease determines one definition, while other definitions consider other significant variables like the disease's severity and the availability of effective therapies.[12]

Examples: -(Cabozantinib, Midazolam, Bedaquiline)[13]





## METHODOLOGY

This study employs a thorough methodology to investigate the trends and failures in the market for orphan medications from 2019 to 2023. Findings from reliable sources that provide light on the workings of the orphan drug market are incorporated into an exhaustive analysis of the literature as a component of the initial research process. The data collecting process then focuses on creating a solid dataset that is gathered from reliable pharmaceutical journals and FDA databases. Examining trends in authorized orphan drugs, statistical analysis is the study's main component. To determine how the regulatory environment has changed during the study period and how it affects approvals as well as setbacks, the regulatory landscape is carefully examined. Through case studies, which provide in-depth insights into both successful and unsuccessful techniques, the methodology offers a comprehensive perspective the creation of orphan drugs. In a certain focus on rejected orphan drugs from 2019 to 2023, the study specifically examines FDA Warning Letters database records. The FDA regulates orphan medications in the United States using a multi-phase regulatory path. The first indication of its purpose for a rare condition is the designation of orphan medication. Standard phases are followed in clinical trials, but because the targeted illness is uncommon, participant cohorts are frequently smaller. One completely New Drug Application (NDA) that includes manufacturing specifics, labeling specifications, and therapeutic use is filed once the required data from preclinical investigations and clinical trials have been compiled. Orphan drug exclusivity, which offers a predetermined period of time without competition, may be granted upon successful scrutiny. The FDA's review centers on safety and efficacy, addressing the special challenges presented by orphan medication. Early engagement with the FDA is encouraged to facilitate constructive dialogue and expedite development of orphan drugs. An advisory committee meeting may be held for external input. The FDA is requested to formally approve a novel medicine intended for marketing and sales in the US through the NDA application.[14]

## RESULTS AND DISCUSSION

Orphan drugs that we identified from the FDA's Orphan Drug Product designation database 2007, There are 421 orphan medications that have been authorized in the recent five years (2019–2023) in the US. This represents the overall number of approvals for orphan drugs. 75 orphan medications were granted approval in 2019; 90 orphan medications are approved in 2020; 93 orphan medications are approved in 2021; 73 orphan medications are approved in 2022, while 90 orphan medications are approved in 2023. It is significant to note that the quantity of orphan medication approvals each year has been increasing and decreasing. The total quantity of orphan drugs approved in the USA between 2019 and 2023 fluctuates. 2021 saw a high amount of orphan drugs approved, whereas 2022 and 2019 saw the lowest numbers of approved drugs—73 and 75, respectively. The quantity of orphan medications licensed in 2020 and 2023 was equal.

**2019:** In 2019, 17.8% of drugs were authorized. This suggests a starting point for drug approvals during the period under observation.

**2020:** Compared to the previous year, the approval rate rise to 21.3% in 2020, indicating a significant rise in drug approval.

**2021:** In 2021, the trend persisted, showing a marginally higher approval percentage of 22.09%. This indicates a consistent upward trend in drugs approvals within this time frame.

**2022:** The approval rate dropped to 17.33% in 2022, however. This decrease deviates from the rising trend that was seen in the years prior.

**2023:** The approval rate increased to 21.3% in 2023, which is comparable to 2020 levels. This revival could point to a comeback. The FDA has sent warning notices to a number of corporations that raise serious questions about the drugs' efficacy, safety, and correct labelling. A synopsis of the main conclusions and ramifications covered in each notification is provided below: A thorough study into possible warning letters was started in 2019 after one orphan drug was rejected. Analysing the substance and significance of these letters may help identify industry practices and regulatory issues that contributed to the drug's rejection. While there were no orphan medication rejections in 2020, a





**Ajay Chandana and Koushik Yetukuri**

close study of warning letters from that time frame can reveal proactive steps taken by pharmaceutical companies to keep their drug approval record spotless. There are serious concerns regarding possible warning letters in light of the spike in 2021 rejections for three orphan medications. To have a thorough picture of the rejection landscape and to gain insights into regulatory issues, it becomes essential to analyse the content and context of these letters. The 2022 rejection of one orphan medicine leads to an examination of related warning letters with the goal of pinpointing particular regulatory issues and providing insight for prospective changes in industry procedures. Two medications were rejected in 2023, which highlights the necessity of carefully reviewing warning letters and provides insightful information to regulatory agencies and the pharmaceutical sector.

**Overall discussion for warning letters**

A recurring topic in these warnings is the misbranding of items as "new drugs" despite their proven ineffectiveness and lack of safety for the intended usage. Inadequate usage instructions are another frequent problem that suggests a need for better adherence to regulatory requirements. Because the FDA consistently finds these kinds of infractions, for organizations to ensure the effectiveness and security of their goods, compliance with regulations is crucial. To maintain the safety and health of the general public and stop such infractions in the future, a thorough and successful corrective action plan is essential.

**CONCLUSION**

The data I collected from 2019 to 2023 shows that, in summary, the Orphan Drug Act of 1983 has significantly influenced the advancement of therapies for rare diseases. Our analysis shows dynamic patterns in orphan medication approvals and rejections using information from the Warning Letters database and the USFDA's Orphan medication Designation and Approval database. The total number of approved drugs was 421 for the previous five years, seven drugs were turned rejected, highlighting the strict regulatory requirements. However, a review of FDA Warning Letters reveals recurrent issues including misbranding, false claims, and inadequate use, our quantitative analysis of approval percentages reveals subtle changes. This report highlights the dynamic nature inside the market, the need of adhering to regulatory standards, and the necessity of taking preventative action when it comes to unusual illnesses, in addition to offering a quantitative summary of orphan medication dynamics.

**CONFLICT OF INTEREST**

The authors have no potential conflict of interest regarding this Investigation.

**ACKNOWLEDGEMENT**

I express my gratitude to the Chalapathi Institute of Pharmaceutical Sciences for their unwavering support, as well as to Mr. Koushik Yetukuri for his guidance and help in seeing this article through to completion.

**REFERENCES**

1. USFDA of orphan drugs <https://www.fda.gov/media/83372/download>
2. USFDA of orphan drugs <https://www.fda.gov/industry/medical-products-rare-diseases-and-conditions>
3. Divino V, DeKoven M, Kleinrock M, Wade RL, Kaura S. Orphan drug expenditures in the United States: a historical and prospective analysis, 2007–18. *Health Affairs*. 2016 Sep 1;35(9):1588-94.
4. Thoene JG. Orphan drugs and orphan tests in the USA. *Community genetics*. 2004 Jan 1;7(4):169-72.
5. USFDA of orphan drug <https://www.fda.gov/patients/rare-diseases-fda#top>
6. Wellman-Labadie O, Zhou Y. The US Orphan Drug Act: rare disease research stimulator or commercial opportunity? *Health Policy*. 2010 May 1;95(2-3):216-28.
7. Divino V, DeKoven M, Kleinrock M, Wade RL, Kaura S. Orphan drug expenditures in the United States: a historical and prospective analysis, 2007–18. *Health Affairs*. 2016 Sep 1;35(9):1588-94.





**Ajay Chandana and Koushik Yetukuri**

8. USFDA of orphan drugs <https://www.fda.gov/about-fda/office-clinical-policy-and-programs/office-orphan-products-development>
9. USFDA of orphan drugs <https://www.fda.gov/industry/faqs-orphan-products-grant-applicants#Application%20Review%20Process%20and%20Timelines>
10. USFDA of orphan drugs <https://www.fda.gov/industry/medical-products-rare-diseases-and-conditions/designating-orphan-product-drugs-and-biological-products>
11. Sharma A, Jacob A, Tandon M, Kumar D. Orphan drug: Development trends and strategies. Journal of Pharmacy and Bioallied Sciences. 2010 Oct;2(4):290.
12. Franco P. Orphan drugs: the regulatory environment. Drug Discovery Today. 2013 Feb 1;18(3-4):163-72.
13. USFDA for orphan drugs <https://www.accessdata.fda.gov/scripts/opdlisting/oo pd/Detailed.cfm? StartRow=26&End Row=50>
14. USFDA for orphan drug, <https://www.fda.gov/drugs/types-applications/new-drugapplication-nda>

**Table 1: -Approved orphan drugs from the year (2019-2023)**

Year	2019	2020	2021	2022	2023
Drugs	75	90	93	73	90

**Table 2: - Percentage of approved orphan drugs from the year (2019-2023)**

Year	percentage of drugs that are approved
2019	17.8
2020	21.3
2021	22.09
2022	17.33
2023	21.3

**Table 3: -Reasons of warning letters**

S. No	Year	Reasons
1.	2019	1.The product is neither safe or effective to use; <b>misbranding</b> was discovered in section 502(f)(1).
2.	2020	-
3.	2021	1.The products were not cleared by the FDA, approved, or sanctioned because of <b>false claims</b> made about the effectiveness and/or safety of COVID-19 therapy. 2. A medication is <b>mislabelled</b> if the usage instructions are insufficient. 3. They weren't shown to be safe and effective for the stated uses, and section 502(f) <b>misbranding</b> occurred.
4.	2022	1.FDA found that the written response was unsatisfactory and that the <b>remedial action plan was inadequate</b> . Specific concerns were raised by the research coordinator's training on the most recent Standard Operating Procedures (SOPs).
5.	2023	1.According to Section 502(f), <b>misbranding</b> occurred, which suggests that it was an ongoing issue at different companies for different lengths of time. 2.The product as a "New drug" under section 201(p) due to the fact that section 502(f) was utilized for <b>misbranding</b> and the product was not generally recognized as safe and effective for the authorized uses.





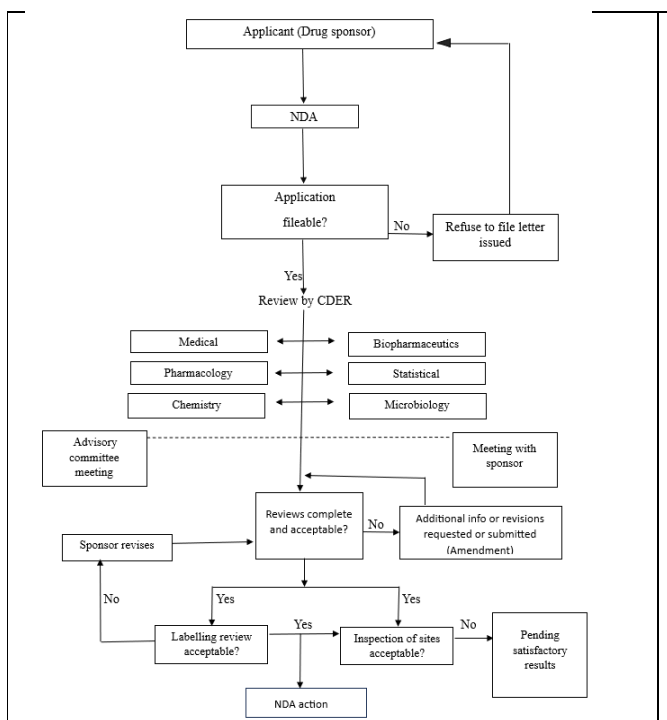
**Ajay Chandana and Koushik Yetukuri**

**Table 4: -Rejected orphan drugs from the year (2019-2023)**

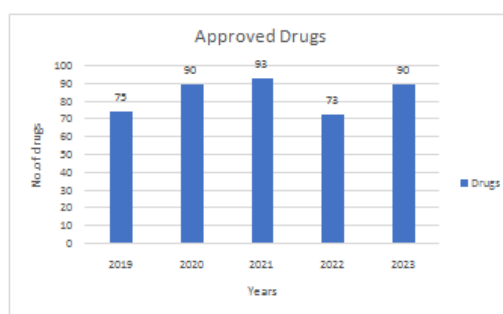
Year	2019	2020	2021	2022	2023
Drugs	1	0	3	1	2

**Table 5: -Rejected and approved orphan drugs from the year (2019-2023)**

Years	Rejected	Approved
2019	1	75
2020	0	90
2021	3	93
2022	1	73
2023	2	90



**Figure 1: -New Drug Application process**

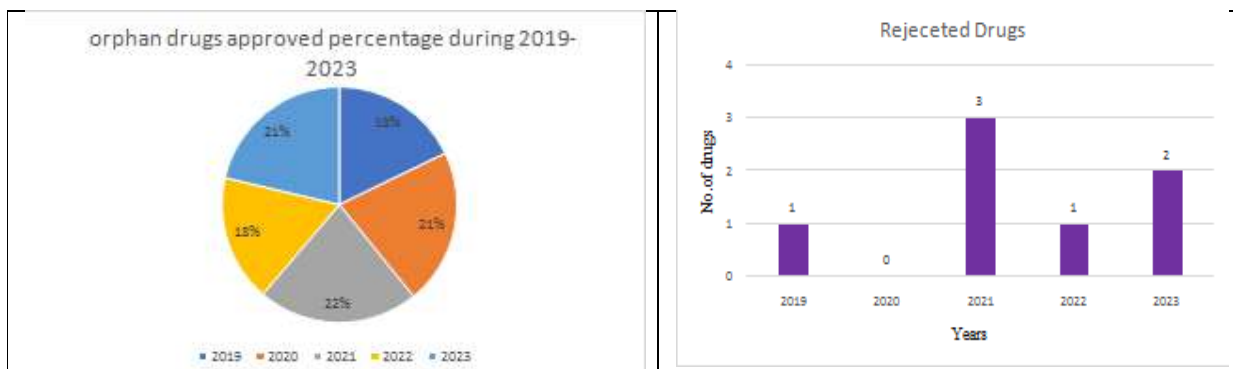


**Figure 2: -Approved orphan drugs from the year (2019-2023)**



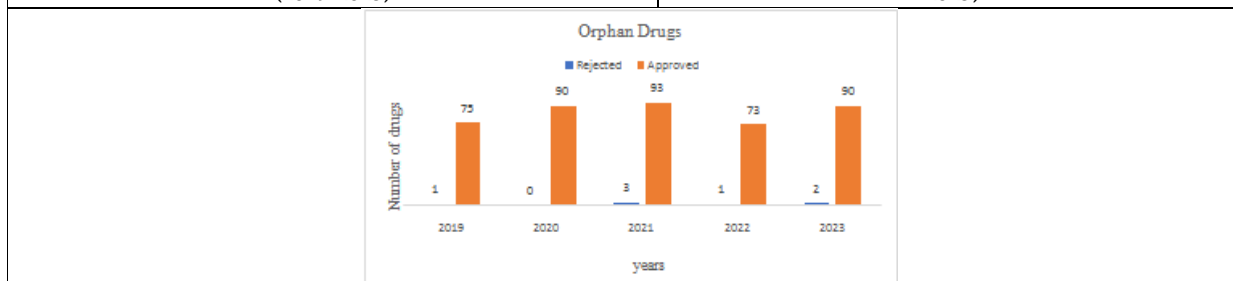


**Ajay Chandana and Koushik Yetukuri**



**Figure 3- Percentage of approved drugs from the year (2019-2023)**

**Figure 4-Rejected orphan drugs from the year (2019-2023)**



**Figure 5 -Rejected and approved orphan drugs from the year (2019-2023)**





## Assessment of Genetic Variability and Association in Morphometric Traits of Rice (*Oryza sativa*. L) Genotypes under Saline Condition

G. Reeth Jessica<sup>1</sup>, S. R. Sruthi<sup>2</sup>, N. Laleeth Kumar<sup>2</sup>, J. Johnny Subakar Ivin<sup>3</sup> and Y. Anbu Selvam<sup>4\*</sup>

<sup>1</sup>PG Scholar, Department of Genetics and Plant Breeding, Faculty of Agriculture, Annamalai University, Chidambaram, Tamil Nadu, India.

<sup>2</sup>Ph.D Scholar, Department of Genetics and Plant Breeding, Faculty of Agriculture, Annamalai University, Chidambaram, Tamil Nadu, India.

<sup>3</sup>Assistant Professor, Mother Teresa College of Agriculture, Illuppur, Pudukkottai (Affiliated to Tamil Nadu Agricultural University) Coimbatore., Tamil Nadu, India.

<sup>4</sup>Professor, Department of Genetics and Plant Breeding, Faculty of Agriculture, Annamalai University, Chidambaram, Tamil Nadu, India.

Received: 22 Jan 2024

Revised: 09 Feb 2024

Accepted: 27 Apr 2024

### \*Address for Correspondence

**Y. Anbu Selvam**

Professor,

Department of Genetics and Plant Breeding,  
Faculty of Agriculture, Annamalai University,  
Chidambaram, Tamil Nadu, India.

Email: yanbuselvam@gmail.com



This is an Open Access Journal / article distributed under the terms of the **Creative Commons Attribution License** (CC BY-NC-ND 3.0) which permits unrestricted use, distribution, and reproduction in any medium, provided the original work is properly cited. All rights reserved.

### ABSTRACT

The current study was conducted on 50 rice genotypes to evaluate the genetic variability and association of various biometrical traits *viz.*, fifty percent flowering, plant height, panicle length, number of tillers per plant, number of grains per panicle, 1000 grain weight with grain yield per plant for under saline environment. The analysis of variance (ANOVA) revealed that the mean sum of squares attributable to genotypes was highly significant for all of the traits tested. The high estimates of variability, heritability coupled with genetic advance observed for traits such as days to flowering, number of grains per panicle and grain yield revealed sufficient genetic variability and indicated most likely the heritability was due to additive gene effects and thus selection could be effective to develop high yielding varieties in future breeding programs. Favorable correlations were detected among yield attributing traits like panicle length, number of grains per panicle and number of tillers per plant, indicating their synergistic relationship for improving productivity. Plant height showed a high negative direct effect on grain yield, while panicle length and thousand seed weight displayed high positive direct effects on grain yield. Panicle length and number of grains per panicle demonstrated high positive indirect effects on grain yield mediated through thousand seed weight, and number of grains per panicle also imparted a high positive indirect effect through panicle length. Number of grains per panicle, panicle length and 1000

73880



**Reeth Jessica et al.,**

seed weight were identified as key predictor traits that could serve as effective selection criteria due to their high heritability, positive correlations and direct plus indirect influences in augmenting grain yield under saline condition.

**Keywords:** Rice, Variability, Heritability, Correlation, Path analysis, Selection.

## INTRODUCTION

Rice, a staple food consumed by one-third of the global population, accounts for nearly 90% of total production in Asia [1]. Even though rice production has more than doubled globally, from 257 million tonnes in 1966 to 600 million tonnes in 2000, the increase has not been able to keep up with demand due to the corresponding rise in population [2]. Salinity is a major cause of yield loss in rice production as it is one of the least salt-tolerant cereal crops [3]. Climate change, coastal storms, and poor water management practices are causing soil salinity to worsen, leading to salt intrusion in agricultural lands and secondary salinization [4]. According to a study by Naifer *et al.* [5] losses acquired by farmers as an outcome of salinity were deliberated to be \$ 1,604 ha<sup>-1</sup> (28%) if the salinity level rises from low to medium and \$ 4,352 ha<sup>-1</sup> (76%) if salinity level falls to high. Soil that contains too much salt reduces its yield potential. Plant breeders now face difficulties in meeting the demand for rice production in the east coast regions due to salt fields caused by the 2004 tsunami in Tamil Nadu, India. Considering the current scenario, it is crucial to focus on developing rice varieties that can endure saline stress. Comprehending the variability of the species, the nature of character associations, and the significance of different traits are critical in boosting grain output through breeding [6]. This study aims to identify traits that could be used to breed salt-tolerant rice in the future.

## MATERIALS AND METHODS

The experiment was conducted at the experimental farm of Genetics and Plant Breeding, Faculty of Agriculture, Annamalai University, Tamil Nadu located at latitude 11°24'N, longitude 79°44'E and height + 5.79 m during January 2022. The pH of the soil was 7.7 and the electrical conductivity (EC) of the soil determined at the beginning of the experiment was 4 dsm<sup>-1</sup>. Twenty-five-day-old seedlings of 50 rice genotypes along with saline tolerant check Pokkali and saline susceptible variety IR 29 were transplanted in the main field adapting a Randomized Block Design (RBD) with three replications. Five randomly selected plants of each genotype were employed in each replication to record observations for parameters such as days to fifty percent flowering, plant height, panicle length, number of tillers per panicle, number of productive tillers per plant, number of grains per panicle, thousand-grain weight and grain yield per plant. Plant production strategies based on need and recommended agronomic practices were implemented. The procedure for analysis of variance proposed by Panse and Sukhatme [7] was followed to estimate the variability. The genotypic and phenotypic coefficients of variation were calculated as per the formula suggested by Burton [8]. GCV and PCV values were categorized as low (0-10%), moderate (11-20%) and high (> 20%) as indicated by Sivasubramanian and Menon [9]. Heritability (broad sense) was calculated by Hanson *et al.* [10]. The heritability percentage was categorized as low (0-30%), moderate (30 -60 %) and high (>60%) as given by Lush [11]. Genetic advance as percent of the mean was categorized as low (0- 10%), moderate (11 – 20%) and high (>20%) as suggested by Johnson et al. [12]. The formulas proposed by Falconer [13] were used to calculate the correlation. The method proposed by Wright [14] and further developed by Dewey and Lu [15] was used to partition the correlation coefficients into direct and indirect effects. As recommended by Lenka and Mishra [16], the scale for path coefficients was characterized. The TNAU STAT statistical package was further utilized to analyze the data and determine the estimates of ANOVA, variability, correlation coefficient and path analysis.



Reeth Jessica *et al.*,

## RESULTS AND DISCUSSION

The analysis of variance revealed significant ( $p \leq 0.01$ ) mean sum of squares values among genotypes for all traits studied (**Table 1**). This denoted that genotype exhibited significant differences across all examined traits, signifying the presence of genetic variability for all the traits. The confirmation of notable genetic diversity made these traits amenable to genetic advancement through selective breeding regimes and allowed for further examination into their genetic framework by utilizing quantitative and population genetic methodologies to gain deeper insights into the existing variation. Similar results were recorded by Lakshmi *et al.* [17]. The degree of variability in a breeding population determines how effective selection is. Therefore, understanding the variability that exists within a gene pool of crop species is crucial for initiating a proficient breeding program. The evaluation of phenotypic and genotypic variability frequently makes use of the coefficient of variation, one of the basic metrics of variability. Heritability estimates along with genetic advance are normally helpful in predicting the gain under selection. The estimates such as PCV, GCV, heritability, and genetic advance for various traits are shown in **Fig 1 & Fig 2**. The days taken for fifty percent of the plants to flower exhibited high phenotypic (22.24%) and genotypic (22.13%) coefficient of variation, along with high heritability (99.03%) and high genetic advance mean percent (45.38%) which aligned with previous findings by Gupta *et al.* [18]. The plant height demonstrated moderate phenotypic (16.95%) and genotypic (16.93%) coefficient of variation, with very high heritability (99.67%) and genetic advance mean percent (34.82%), which was in line with the results of Kumar *et al.* [19]. Panicle length explained a moderate phenotypic coefficient of variation (10.77%) despite low genotypic coefficient of variation (9.63%), with high heritability (80.01%) and moderate genetic advance mean percent (17.75%), which was consistent with the findings of Kondi *et al.* [20].

The number of tillers per plant featured moderate phenotypic (16.06%) and genotypic (15.03%) coefficient of variation, accompanied by high heritability (87.48%) and genetic advance mean per cent (28.96%), which reinforced similar reports by Sandeep *et al.* [21] and Sruthi *et al.* [22]. High phenotypic (25.30%) and genotypic (25.29%) coefficient of variation with high heritability (99.96%) and genetic advance (52.10%) were detected for number of grains per panicle [23]. High phenotypic (37.58%) and moderate genotypic (16.60%) coefficient of variation with low heritability (25.52%) and moderate genetic advance (16.24%) were established for thousand seed weight [24]. Grain yield exhibited high phenotypic variation (32.92%), genotypic variation (32.67%) coupled with high heritability (98.47%) coupled with high genetic advance (66.79%), which was in line with the reports of Gupta *et al.* [18]. The relatively marginal differences observed between phenotypic and genotypic coefficients of variation of all traits except thousand seed weight suggested that environmental factors had limited impact on the variability in trait expression for this particular population and study location. This indicated the traits are largely under genetic control rather than environmental fluctuation and therefore selection for improvement of such traits would be rewarding. The high estimates of variability, heritability coupled with genetic advance observed for traits such as days to flowering, number of grains per panicle and grain yield revealed sufficient genetic variability and indicated most likely the heritability was due to additive gene effects and thus selection could be effective to develop high yielding varieties in future breeding programs. To understand the extent of association between the studied traits and to emphasize their relevance for rice breeding, a correlation coefficient summarizing the relationships between all variable combinations was generated and presented in **Table 2**.

The current investigation explained that grain yield had a highly significant ( $p \leq 0.01$ ) positive association with the number of tillers per plant [25] and high significant negative correlations with plant height [26] and days to fifty percent flowering [27]. Additionally, grain yield demonstrated significant ( $p \leq 0.05$ ) positive correlations with panicle length [28] and number of grains per panicle [29]. However, grain yield was negatively correlated with thousand grain weight and this relationship was statistically significant [30]. In summary, grain yield was favorably associated with yield components like number of tillers per plant and grains per panicle, while being negatively impacted by increased plant height and days to flowering. The correlations observed provide insight into important trait relationships influencing productivity in rice. A highly significant ( $p \leq 0.01$ ) positive phenotypic and genotypic correlation was observed between plant height and panicle length [31]. Days to 50 percent flowering showed a



**Reeth Jessica et al.,**

significant ( $p \leq 0.05$ ) negative phenotypic and genotypic association with panicle length [32] and number of tillers per plant [33]. Panicle length exhibited a robust highly significant ( $p \leq 0.01$ ) positive correlation, both phenotypically and genotypically, with the number of tillers per plant [34]. The number of grains per panicle trait revealed highly significant ( $p \leq 0.01$ ) positive phenotypic and genotypic correlations with days to 50 percent flowering [35], plant height [36], panicle length [32] and number of tillers per plant [37]. Thousand grain weight demonstrated highly significant ( $p \leq 0.01$ ) positive genotypic correlations with panicle length, number of tillers per plant, and number of grains per panicle [38]. Additionally, a significant ( $p \leq 0.05$ ) positive phenotypic correlation occurred between thousand seed weight and panicle length. Overall, largely favorable correlations were detected among yield-attributing traits like panicle length, number of grains per panicle and number of tillers per plant, indicating their synergistic relationship for improving productivity.

Path analysis indicating the direct and indirect effects of component traits on yield was presented in Table 3. Plant height showed a high negative direct effect on grain yield [35], while panicle length [39] and thousand seed weight [40] displayed high positive direct effects on grain yield. Days to 50 percent flowering unveiled a moderately negative direct effect on grain yield, whereas the number of tillers per plant exhibited a moderately positive direct effect. Similar results showing high direct effect was recorded by Singh *et al.* [41]. Panicle length and number of grains per panicle demonstrated high positive indirect effects on grain yield mediated through thousand seed weight [42], and number of grains per panicle also imparted a high positive indirect effect through panicle length [2]. The residual effect of 0.2346 suggested that yield was not solely dictated by the yield component traits measured in this analysis alone, implying other unidentified and unexplained traits extrinsic to those analyzed were acting in conjunction with yield as well. Hence further work would be needed to elucidate other yield-affiliated traits. Number of grains per panicle, panicle length and 1000 grain weight were identified as key predictor traits that could serve as effective selection criteria due to their high heritability, positive correlations and direct plus indirect influences in augmenting grain yield under saline conditions.

## ACKNOWLEDGEMENT

The authors are grateful to the Department of Genetics and Plant Breeding, Faculty of Agriculture, Annamalai University, Tamil Nadu for supporting and providing all the necessary facilities to conduct this research.

## REFERENCES

1. Virmani, S. S. (1996). Hybrid rice. *Advances in agronomy*, 57, 377-462.
2. Sarker, U. (2020). Variability, heritability, character association, and path coefficient analysis in advanced breeding lines of rice (*Oryza sativa* L.). *Genetika*, 52(2), 711-726.
3. Munns, R., & Tester, M. (2008). Mechanisms of salinity tolerance. *Annu. Rev. Plant Biol.*, 59, 651-681.
4. Naifer, A., Al-Rawahy, S. A., & Zekri, S. (2011). Economic impact of salinity: the case of Al-Batinah in Oman. *International Journal of Agricultural Research*, 6(2), 134-142.
5. Gerona, M. E. B., Deocampo, M. P., Egdane, J. A., Ismail, A. M., & Dionisio-Sese, M. L. (2019). Physiological responses of contrasting rice genotypes to salt stress at reproductive stage. *Rice Science*, 26(4), 207-219.
6. Yadav, A. K., Kumar, A., Grover, N., Ellur, R. K., Bollinedi, H., Krishnan, S. G., ... & Singh, A. K. (2021). Genome-wide association study reveals marker-trait associations for early vegetative stage salinity tolerance in rice. *Plants*, 10(3), 559.
7. V. G. Panse and P. V. Sukhatme, "Statistical Methods for Agricultural Workers," 2nd Edition, Indian Council of Agricultural Research, New Delhi, 1967.
8. Burton, G.W. 1952. Quantitative inheritance in grasses. In: Proc. 6th Inter Grassland Congr. 1: 277 - 283.
9. Sivasubramanian, J. and Madhavamenon, P. (1973). Genotypic and phenotypic variability in rice. *Madras Agricultural Journal*, 12, 15-16.







## Reeth Jessica et al.,

10. Hanson, C. H., Robinson, H. F. and Comstock, R. E. (1956). Biometrical studies of yield in segregating population of Korean lespedeza 1. *Agronomy Journal*, 48(6), 268-272.
11. Lush, J. L. (1940). Intra-sire correlations or regressions of offspring on dam as a method of estimating heritability of characteristics. *Journal of animal science*, 1940(1), 293-301
- Johnson, H. W., Robinson, H. F. and Comstock, R. E. (1955). Genotypic and phenotypic correlations in Soybean and their application in selection. *Agronomy Journal*, 47:477-483
12. Falconer, D.S. 1964. An introduction to quantitative genetics. Second Edition. Oliver and Boyd, Edinburgh. pp. 312-324.
13. Wright, S. (1921). Correlation and causation.
14. Dewey, D. R., & Lu, K. (1959). A correlation and path-coefficient analysis of components of crested wheatgrass seed production 1. *Agronomy journal*, 51(9), 515-518.
15. Lenka, D., & Mishra, B. (1973). Path coefficient analysis of yield in rice varieties. *Indian J. Agric. Sci*, 43(4), 376.
16. Lakshmi, M., Shanmuganathan, M., Jeyaprakash, P., & Ramesh, T. (2022). Genetic variability and diversity analysis in selected rice (*Oryza sativa* L.) varieties. *Electronic Journal of Plant Breeding*, 13(3), 959-966.
17. Gupta, H., Purushottam, G. Y., Yadav, S. K., Singh, S., & Kumar, S. (2022). Genetic variability, heritability and genetic advance for yield and its related traits in rainfed upland rice (*Oryza sativa* L.) genotypes. *The Pharmac Innov J*, 11(2), 2520-2524.
18. Kumar, N. L., Saravanan, S., Pillai, M. A., & Sheela, J. (2022). Study on morphometric characterization for yield and yield contributing attributes in traditional rice (*Oryza sativa* L.) varieties.
19. Kondi, R. K. R., Kar, S., & Mandawi, N. C. (2022). Study of genetic parameters, correlation and path analysis for yield and quality characters in fine-scented rice genotypes. *ORYZA-An International Journal of Rice*, 59(1), 20-30.
20. Sandeep, S., Sujatha, M., Subbarao, L. V., & Neeraja, C. N. (2018). Genetic variability, heritability and genetic advance studies in rice (*Oryza sativa* L.). *International Journal of Current Microbiology and Applied Science*, 7(12), 3719-3727.
21. Sruthi, S. R., Laleeth Kumar, N., Anbu Selvam, Y., Joshi, J. L., & Ivin, J. S. Genetic variability Studies in Rice (*Oryza sativa* L.) varieties for Three Seasons under Saline conditions of Annamalai Nagar, an East Coast Region of Tamil Nadu.
22. Naik, M., Pillai, M. A., & Saravanan, S. (2021). Genetic diversity analysis for yield associated and quality traits in promising rice varieties of Tamil Nadu. *International Journal of Bio-resource and Stress Management*, 12(4), 361-369.
23. Bhargava, K., Shivani, D., Pushpavalli, S. N. C. V. L., Sundaram, R. M., Beulah, P., & Senguttuvel, P. (2021). Genetic variability, correlation and path coefficient analysis in segregating population of rice. *Electronic Journal of Plant Breeding*, 12(2), 549-555.
24. Singh, K. S., Suneetha, Y., Kumar, G. V., Rao, V. S., Raja, D. S., & Srinivas, T. (2020). Variability, correlation and path studies in colored rice. *Int J Chem Stud*, 8(4), 2138-2144.
25. Mandal, A., Lal, G. M., & Lavanya, G. R. (2023). Assessment of genetic variability, correlation and path analysis among rice (*Oryza sativa* L.) landraces genotypes for grain yield characters under irrigated. *International Journal of Environment and Climate Change*, 13(10), 55-65.
26. Thuy, N. P., Trai, N. N., Khoa, B. D., Thao, N. H. X., Phong, V. T., & Thi, Q. V. C. (2023). Correlation and Path analysis of association among yield, micronutrients, and protein content in rice accessions grown under aerobic condition from Karnataka, India. *Plant breeding and biotechnology*, 11(2), 117-129.
27. Jangala, D. J., Amudha, K., Geetha, S., & Uma, D. (2022). Studies on genetic diversity, correlation and path analysis in rice germplasm. *Electronic Journal of Plant Breeding*, 13(2), 655-662.
28. Mohan, Y. C., Krishna, K., Krishna, L., Singh, T. V. J., & Jagadeeshwar, R. (2023). Genetic parameters and association analysis for grain yield and yield attributing traits in rice (*Oryza sativa* L.) germplasm lines. *Environment Conservation Journal*, 24(3), 1-7.
29. Fentie, D. B., Abera, B. B., & Ali, H. M. (2021). Association of agronomic traits with grain yield of lowland rice (*Oryza Sativa* L.) genotypes. *Int. J. Agric. Sci*, 8, 161-175.





**Reeth Jessica et al.,**

30. Kayastha, P., Chand, H., Barsha, K. C., Pandey, B., Magar, B. R., Bhandari, J., ... & Poudel, M. R. (2022). Correlation coefficient and path analysis of yield and yield attributing characters of rice (*Oryza sativa* L.) genotypes under reproductive drought stress in the Terai region of Nepal. *Archives of Agriculture and Environmental Science*, 7(4), 564-570.
31. Priyanka, A. R., Gnanamalar, R. P., Banumathy, S., Senthil, N., & Hemalatha, G. (2019). Genetic variability and frequency distribution studies in F<sub>2</sub> segregating generation of rice. *Electronic Journal of Plant Breeding*, 10(3), 988-994.
32. Thippani, S., Kumar, S. S., Senguttuvel, P., & Madhav, M. S. (2017). Correlation analysis for yield and yield components in rice (*Oryza sativa* L.). *International Journal of Pure & Applied Bioscience*, 5(4), 1412-1415.
33. Manivelan, K., Juliet Hepziba, S., Suresh, R., Theradimani, M., Renuka, R., & Gnanamalar, R. P. (2022). Inherent variability, correlation and path analysis in lowland rice (*Oryza sativa* L.). In *Biological Forum—An International Journal* (Vol. 14, No. 2, pp. 771-778).
34. Williams, K., Mishra, A., Verma, A., Suresh, B. G., & Lavanya, G. R. (2021). Genetic variability and correlation studies for yield and yield-related traits in rice (*Oryza sativa* L.) genotypes. *International Journal of Current Microbiology Applied Science*, 10(01), 752-764.
35. Lilly, M. S. (2018). Association studies in F<sub>2</sub> population for yield and quality traits in rice (*Oryza sativa* L.). *Electronic Journal of Plant Breeding*, 9(4), 1362-1369.
36. Anbu Selvam, Y., Sruthi, S. R., Kumar, N. L., Ivin, J., Williams, G., & Joshi, J. L. (2023). Genetic Studies for Determination of Yield Components in Rice (*Oryza sativa* L.) Varieties under Saline Conditions Pooled Over Seasons. *International Journal of Environment and Climate Change*, 13(10), 954-959.
37. Prasanna Kumari, M., Akilan, M., Kalaiselvan, S., Subramanian, A., Janaki, P., & Jeyaprakash, P. (2020). Studies on genetic parameters, correlation and path analysis for yield attributes and Iron content in a backcross population of rice [*Oryza sativa* (L.)]. *Electronic Journal of Plant Breeding*, 11(03), 881-886.
38. Islam, S. S., Nualsri, C., & Hasan, A. K. (2021). Character association and path analysis studies in upland rice (*Oryza sativa*) genotypes. *Research on Crops*, 22(2), 239-245.
39. Rajasekar, R., Jeyaprakash, P., Manonmani, K., Nithila, S., & Thirumurugan, T. (2021). Trait relationship and path analysis under sodicity in Nagina 22 rice mutants. *Electronic Journal of Plant Breeding*, 12(3), 963-968.
40. Singh, S. K., Habde, S., Singh, D. K., Khaire, A., Mounika, K., & Majhi, P. K. (2020). Studies on character association and path analysis studies for yield, grain quality and nutritional traits in the F<sub>2</sub> population of rice (*Oryza sativa* L.). *Electronic Journal of Plant Breeding*, 11(3), 969-975.
41. Devi, K. R., Chandra, B. S., Lingaiah, N., Hari, Y., & Venkanna, V. (2017). Analysis of variability, correlation and path coefficient studies for yield and quality traits in rice (*Oryza sativa* L.). *Agricultural Science Digest-A Research Journal*, 37(1), 1-9.

**Table 1. Analysis of variance (ANOVA)**

Source	df	Days to fifty percent flowering (%)	Plant height(cm)	Length of the panicle (cm)	Number of tillers per plant	Number of grains per panicle	1000 grain weight (gm)	Grain yield per plant (gm)
<b>Mean sum of squares</b>								
<b>Replication</b>	2	7.26	2.65	9.73	5.82	82.29	151.4	0.003
<b>Genotypes</b>	48	1320.53**	1128.87**	16.60**	41.77**	3804.05**	93.35**	1.639**
<b>Error</b>	98	4.28	1.21	1.27	1.9	0.48	84.12	0.003

df – degrees of freedom    \*\*Significance at 1% level    \*Significance at 5% level





**Reeth Jessica et al.,**

**Table 2. Genotypic and phenotypic correlation among various characters of fifty genotypes**

Characters		Days to fifty percent flowering	Plant height	Length of the panicle	Number of tillers per plant	Number of grains per panicle	1000 grain weight	Grain yield per plant
Days to fifty percent flowering	G	1						
	P	1						
Plant height	G	0.406	1					
	P	0.404	1					
Length of the panicle	G	-0.048*	0.346**	1				
	P	-0.035*	0.309**	1				
Number of tillers per plant	G	-0.162*	0.011	0.363**	1			
	P	-0.148*	0.008	0.312**	1			
Number of grains per panicle	G	0.0113*	0.349**	0.535**	0.558**	1		
	P	0.0112*	0.348**	0.481**	0.521**	1		
1000 grain weight	G	-0.42	0.136	1.280**	0.332**	0.592**	1	
	P	-0.082	0.026	0.164*	0.021	0.111	1	
Grain yield per plant	G	-0.178*	-0.471**	0.168*	0.272**	0.146	-0.087	1
	P	-0.176*	-0.466**	0.14	0.259**	0.145	-0.014	1

\*\*Significance at 1% level \*Significance at 5% level

G - Genotypic correlation co-efficient P - Phenotypic correlation co-efficient

**Table 3. Path coefficient analysis for various characters of fifty genotypes**

Effect of the characters	Days to fifty percent flowering	Plant height	Length of the panicle	Number of tillers per plant	Number of grains per panicle	1000 grain weight
Days to fifty percent flowering	<b>0.2773</b>	-0.2235	0.0214	-0.0388	0.0015	-0.215
Plant height	0.1128	<b>-0.5494</b>	-0.1535	0.0026	0.0473	0.0698
Length of the panicle	-0.0134	-0.1902	<b>-0.4436</b>	0.087	0.0724	0.6566
Number of tillers per plant	-0.045	-0.006	-0.1611	<b>0.2394</b>	0.0756	0.1703
Number of grains per panicle	0.0031	-0.1917	-0.2372	0.1336	<b>0.1355</b>	0.3035
1000 grain weight	-0.1167	-0.0748	-0.5677	0.0795	0.0801	<b>0.513</b>

Values on diagonal – direct effects

Residual effect – 0.2346





Reeth Jessica et al.,

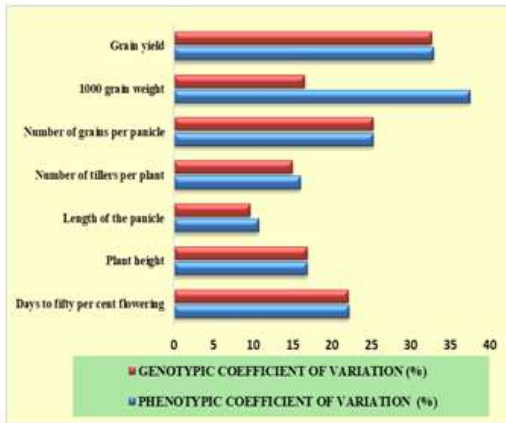


Fig 1: Phenotypic and Genotypic coefficient of variation for seven yield-attributing attributes



Fig 2: Heritability and Genetic advance as percentage of the mean for seven yield attributing attributes





## Water Quality Assessment of Lakes in and around Khuldabad Dist. Aurangabad, Maharashtra, India

Syed Yousuf Hussain\*

Associate Professor, Department of Chemistry, Kohinoor Arts, Commerce & Science College (Affiliated to Dr Babasaheb Ambedkar Marathwada University) Aurangabad, Maharashtra, India.

Received: 12 Jan 2024

Revised: 09 Feb 2024

Accepted: 26 Apr 2024

### \*Address for Correspondence

**Syed Yousuf Hussain**

Associate Professor,

Department of Chemistry,

Kohinoor Arts, Commerce & Science College

(Affiliated to Dr Babasaheb Ambedkar Marathwada University)

Aurangabad, Maharashtra, India.

Email: sdyusufchem@gmail.com



This is an Open Access Journal / article distributed under the terms of the **Creative Commons Attribution License** (CC BY-NC-ND 3.0) which permits unrestricted use, distribution, and reproduction in any medium, provided the original work is properly cited. All rights reserved.

### ABSTRACT

In the present study Water Quality Index (WQI) was calculated of the water of five lakes in and around Khuldabad, Dist Aurangabad, Maharashtra, India to assess the usage of the water. The water quality indices were calculated following the procedure given by Brown et al. The water samples from the above lakes is collected and analyzed for the following parameters pH, Dissolved Oxygen, Biological Oxygen Demand, Sulphates, Nitrates, Chlorides, Fluorides, Alkalinity, Total Hardness and Total Dissolved Solids. The WQI of the Bani Begum Bagh Lake was found to be 55.30 (Poor), HauzKhas Lake 56.80 (Poor), TalyachiWadi Lake 48.83 (Good), PariyonKaTalab 86.74 (Very Poor) and Khaksar Lake 73.37 (Poor). On the basis of results obtained it was concluded that the most of the lake waters were of poor grade and therefore recommended to higher authorities and local public to process the water before drinking and other usage.

**Keywords:** Water Quality Index, Physico-chemical parameters, Lake, Analysis, Quality rating

### INTRODUCTION

One of the most important component required for existence of life is water. It is existed in rivers, lakes oceans and a major part as ground water. The water has great impact on the life on earth in particular living beings [1]. It affects directly the health, hygiene, industries, agriculture and local needs of humans and animals. The surface water is the direct source of water for the drinking, irrigation and other needs in many of the villages, towns and cities [2]. The town Khuldabad is situated at about 2732 feet above mean sea level. The main source of water for drinking purpose





### Syed Yousuf Hussain

is the lakes in and around the town. The municipal council filters and processes the water to supply for drinking to people of the town. The lakes in and around Khuldabad town are used by locals to wash their animals, cloths, vehicles, etc and drinking for the animals. Nowadays the villagers dump their household garbage and sewage water to the lakes which makes it so much polluted that it cannot be used for drinking purpose. It is therefore decided to study the water quality of the lakes in and around Khuldabad town. Many researchers also studied the water quality index for rivers, lakes and ground water. HeerojeetRajkumar et al (2022) [3] studied the potability of ground water samples of Nalagarh Valley, Himachal Pradesh, India using water quality index and found most of samples were of 'good' quality. Abdul Meraj et al (2017) studied the water quality index of SagarDighi, Koch, Bihar, West Bengal, India for suitability of water for drinking, bathing and swimming. They found that the water is not suitable for drinking [4]. Water Quality Index of ground water of Jakkur Watershed, Bangalore, Karnataka, India was studied by M Inayatullah and J.M. Pual (2013) and assessed that the water quality is good and suitable for drinking and other purposes [5].

#### Study Area

Khuldabad is a smallest Taluka of Aurangabad District with area 511.89km<sup>2</sup>. It is a in central part of Maharashtra state. Its latitude is 20.007555 and longitude is 75.192474. It is a municipal council and town with population about 12000. It is an important tourist attraction with number of historical places like Aurangzeb's tomb, ZainuddinShiraziDargah, ShriBhadraMaroti Temple, one of the twelve Jyotirlinga at Ghrushneshwar Temple, Ellora Caves, hill station Mhaismal and many others. Thousands of tourist from Maharashtra, Other states and even from other countries visit Khuldabad due to these tourist attractions.

#### Sampling Stations

There are number of lakes in and around Khuldabad town which serve as the source of water for drinking purpose [6]. It is an attempt to check whether the water of these lakes is suitable for the drinking or not. For this study few close to the town lakes are selected Fig. 6. They are 1) Bani Begum Lake Fig. 1, 2) HauzKhas Lake Fig. 2, 3) TalyachiWadi Lake Fig. 3, 4) PariyonkaTalab Lake Fig. 4 and 5)Khaksar Lake Fig. 5. All these lakes are within the five kilometer range from the town whereas Bani Begum Lake and HauzKhas Lake are within the town itself. Maps of these study area are given below.

## MATERIALS & METHODS

The study is conducted in the month of May 2023. The lake water is collected in the plastic bottles prewashed with double distilled water in the morning time from 9 a.m. to 10 a.m. The collected water is analyzed for different physico-chemical parameters like pH, total dissolved solids, total suspended solids, total alkalinity, total hardness, chlorides, dissolved oxygen and bio-chemical oxygen demand. The analysis for the selected parameters is carried out following procedure given by APHA [7]. Water Quality Index is calculated using weighted arithmetic procedure given by Brown et al 1972 [8]. It is calculated following the steps given below.

- **Data Collection:** The observed values of the selected physico-chemical parameters is tabulated for further calculation i.e.  $V_n$  (Observed Value for  $n^{\text{th}}$  parameter).
- **Known Values Collection:** The ideal values permissible limits of the selected parameters are tabulated i.e.  $V_i$  and  $S_n$  ( $V_i$ = Ideal values for pH is 7, Dissolved Oxygen is 14.6 and for remaining parameters it is 0,  $S_n$ = Standard Permissible limit for  $n^{\text{th}}$  parameter)
- **Proportionality Constant Calculation:** The proportionality constant K is calculated using the formula given below.

$$\frac{1}{1/\sum_{i=1}^n (S_n)}$$





### Syed Yousuf Hussain

- **Quality Rating Calculation:** The quality rating ( $Q_n$ ) for  $n^{\text{th}}$  parameter is calculated using the formula given below.

$$Q_n = 100 \times [(V_n - V_i) / (S_n - V_i)]$$

- **Unit Weight Calculation:** The unit weight ( $W_n$ ) for each parameter is inversely proportional to the standard permissible limit for  $n^{\text{th}}$  parameter i.e.

$$W_n \propto \frac{1}{S_n} \\ W_n = \frac{K}{S_n}$$

where K is proportionality constant.

- **Water Quality Index Calculation:** The water quality index can be calculated using the formula given below.

$$WQI = \sum W_n \times Q_n / W_n$$

- **Assigning Water Quality Index to the Water Body:** On the basis of water quality index calculated the quality of water can be assigned with the following reference in Table I.

#### Merits of Water Quality Index

There are different advantages of using Water Quality Index like [8],

- Few parameters are required to compare water quality for a particular use.
- A single number is assigned for a certain location and time.
- Assurance of safety of usage of water for drinking, irrigation and other use.
- Effective method for monitoring quality of water.
- Comparative study for different water bodies becomes easy.
- Single figure output gives important information to public higher authorities and many more are the benefits of the water quality index.

## RESULTS & DISCUSSION

The water quality assessment of lakes in and around Khuldabad town is done by selecting various physico-chemical parameters like pH, Dissolved Oxygen, Biological Oxygen Demand, Sulphates, Nitrates, Chlorides, Fluoride, Alkalinity, Total Hardness, Total Dissolved Solids and their values are tabulated in Table 2. for different lakes. The water quality assessment is completed following the procedure given by Brown et al. [2]. The calculation of WQI for Bani Begum Lake is calculated and tabulated in Table 3, for HauzKhas Lake in Table 4, for TalyachiWadi Lake in Table 5, for PariyonkaTalab Lake in Table 6 and for Khaksar Lake in Table 7. As per the table 1, the results obtained reveals that the WQI for the Bani Begum Lake is 55.30 which indicates its category is poor. The HauzKhas Lake has WQI value 56.80, it also comes under the category of poor. The TalyachiWadi Lake's WQI value is 48.83 which indicates it is good. The PariyonkaTalab Lake has WQI 86.74 which is very poor category and the Khaksar Lake has WQI value 73.37 it also comes under the category of poor. Overall most of the lakes in and around the Khuldabad town has poor water quality which cannot be used for drinking purpose.

## REFERENCES

1. E. Del Giudice, V. Elia, and A. Tedeschi, "The role of water in the living organisms," *Neural Netw. World*, vol. 19, no. 4, p. 355, 2009.
2. R. Kumar, R. D. Singh, and K. D. Sharma, "Water resources of India," *Curr.Sci.*, pp. 794–811, 2005.
3. H. Rajkumar, P. K. Naik, and M. S. Rishi, "A comprehensive water quality index based on analytical hierarchy process," *Ecol. Indic.*, vol. 145, p. 109582, 2022.





**Syed Yousuf Hussain**

4. A. Miraj and S. K. Bhattacharya, "Assessment Of Water Quality Index (Wqi) And Suitability Of SagarDighi, Koch Bihar, West Bengal, In-dia," *Int. J. Pharm. Drug Anal.*, pp. 467–474, 2017.
5. M. Inayathulla and J. M. Paul, "Water quality index assessment of ground water in Jakkur sub watershed of Bangalore, Karnataka, India," *Int J Civ. StructEnv.InfrastructEng Res Dev*, vol. 1, no. 3, pp. 99–108, 2013.
6. Y. Mubayi, "KHULDABAD-DAULATABAD", Accessed: Jan. 11, 2024. [Online]. Available: <https://www.sahapedia.org/sites/default/files/2019-03/Water%20Design%20Paper%20Marg%20%281%29.pdf>
7. A. P. H. Association, *Standard methods for the examination of water and wastewater*, vol. 6. American Public Health Association, 1926.
8. R. O. A. Adelagun, E. E. Etim, and O. E. Godwin, "Application of water quality index for the assessment of water from different sources in Nigeria," *Promis. Tech. Wastewater Treat. Water Qual. Assess.*, vol. 267, p. 25, 2021.

**Table 1: Water Quality Index and Status of Water Body**

Water Quality Index Value	Status of Water Body
0 - 25	Excellent
26 - 50	Good
51 - 75	Poor
76 - 100	Very Poor
More than 100	Unsuitable for use

**Table 2: Physico-chemical parameters for the selected lakes of Khuldabad**

Parameters	Bani Begum Lake	HauzKhas Lake	TalyachiWadi Lake	PariyonKaTalab Lake	Khaksar Lake
pH	8.0	7.8	7.8	8.9	7.8
Dissolved Oxygen (mg/L)	4.8	5.5	4.9	3.3	4.5
Biological Oxygen Demand (mg/L)	0.8	1.2	0.9	1.4	1.8
Sulphates (mg/L)	42	40	42	58	42
Nitrates (mg/L)	0.8	1.9	0.8	3.0	0.9
Chlorides (mg/L)	72	60	54	96	62
Fluoride (mg/L)	0.3	0.2	0.2	0.2	0.3
Alkalinity (mg/L)	42	36	32	48	38
Total Hardness (mg/L)	56	50	36	64	40
Total Dissolved Solids (mg/L)	242	180	220	282	216







**Syed Yousuf Hussain**

**Table 3: WQI Calculation of Bani Begum Lake**

Sr. No	Parameters	Vn	Vi	Sn	1/Sn	Wn	Vn-Vi	(Sn-i)	(Vn-Vi)/(Sn-Vi)	Qn=100(Vn-Vi)/(Sn-Vi)	Wn X Qn
1	pH	8	7	8.5	0.117	0.064	1	1.5	0.666	66.666	4.294
2	Dissolved Oxygen (mg/L)	3.2	14.6	6	0.166	0.091	-11.4	-8.6	1.325	132.55	12.098
3	Biological Oxygen Demand (mg/L)	1.2	0	2	0.5	0.273	1.2	2	0.6	60	16.428
4	Sulphates (mg/L)	42	0	200	0.005	0.0027	42	200	0.21	21	0.057
5	Nitrates mg/L)	5.6	0	45	0.022	0.012	5.6	45	0.124	12.44	0.151
6	Chlorides (mg/L)	85	0	250	0.004	0.0021	85	250	0.34	34	0.074
7	Fluoride (mg/L)	0.4	0	1	1	0.547	0.4	1	0.4	40	21.904
8	Alkalinity (mg/L)	126	0	200	0.005	0.0027	126	200	0.63	63	0.172
9	Total Hardness (mg/L)	108	0	300	0.003	0.0018	108	300	0.36	36	0.065
10	Total Dissolved Solids (mg/L)	242	0	500	0.002	0.001	242	500	0.484	48.4	0.053
						$\sum W_n = 0.9998$			$\sum W_n \times Q_n = 55.29$		
<b>WQI = <math>\sum W_n \times Q_n / \sum W_n = 55.29 / 0.9998 = 55.308</math></b>											

**Table 4: WQI Calculation of HauzKhas Lake**

Sr. No	Parameters	Vn	Vi	Sn	1/Sn	Wn	Vn-Vi	Sn-Vi	Vn-Vi/Sn-Vi	Qn=100(Vn-Vi)/(Sn-Vi)	Wn X Qn
1	pH	7.9	7	8.5	0.117	0.0644	0.9	1.5	0.6	60	3.865
2	Dissolved Oxygen (mg/L)	2.8	14.6	6	0.166	0.0912	-11.8	-8.6	1.372	137.2	12.522
3	Biological Oxygen Demand (mg/L)	1.3	0	2	0.5	0.273	1.3	2	0.65	65	17.797
4	Sulphates (mg/L)	54	0	200	0.005	0.0027	54	200	0.27	27	0.073
5	Nitrates mg/L)	10	0	45	0.022	0.0121	10	45	0.222	22.22	0.2704
6	Chlorides (mg/L)	110	0	250	0.004	0.0021	110	250	0.44	44	0.0963
7	Fluoride (mg/L)	0.4	0	1	1	0.547	0.4	1	0.4	40	21.904
8	Alkalinity (mg/L)	92	0	200	0.005	0.0027	92	200	0.46	46	0.125
9	Total Hardness (mg/L)	148	0	300	0.003333	0.0018	148	300	0.493	49.33	0.090
10	Total Dissolved Solids (mg/L)	240	0	500	0.002	0.0010	240	500	0.48	48	0.052
						$\sum W_n = 0.999$			$\sum W_n \times Q_n = 56.79$		
<b>WQI = <math>\sum W_n \times Q_n / \sum W_n = 56.79 / 0.999 = 56.80</math></b>											

**Table 5: WQI Calculation of TalyachiWadi Lake**

Sr. No	Parameters	Vn	Vi	Sn	1/Sn	Wn	Vn-Vi	Sn-Vi	Vn-Vi/Sn-Vi	Qn=100(Vn-Vi)/(Sn-Vi)	Wn X Qn
1	pH	7.8	7	8.5	0.117	0.064	0.8	1.5	0.533	53.333	3.435
2	Dissolved Oxygen (mg/L)	4.6	14.6	6	0.166	0.0912	-10	-8.6	1.16	116.27	10.61





**Syed Yousuf Hussain**

3	Biological Oxygen Demand (mg/L)	1.3	0	2	0.5	0.2738	1.3	2	0.65	65	17.79
4	Sulphates (mg/L)	32	0	200	0.005	0.0027	32	200	0.16	16	0.043
5	Nitrates mg/L)	6.2	0	45	0.022	0.0121	6.2	45	0.137	13.77	0.167
6	Chlorides (mg/L)	68	0	250	0.004	0.0021	68	250	0.272	27.2	0.059
7	Fluoride (mg/L)	0.3	0	1	1	0.5476	0.3	1	0.3	30	16.42
8	Alkalinity (mg/L)	112	0	200	0.005	0.0027	112	200	0.56	56	0.153
9	Total Hardness (mg/L)	140	0	300	0.003	0.001	140	300	0.466	46.66	0.085
10	Total Dissolved Solids (mg/L)	220	0	500	0.002	0.0010	220	500	0.44	44	0.0481
						$\sum W_n = 0.999$					$\sum W_n \times Q_n = 48.83$
<b>WQI = <math>\sum W_n \times Q_n / \sum W_n = 48.83 / 0.999 = 48.83</math></b>											

**Table 6: WQI Calculation of PariyonKaTalab Lake**

Sr. No	Parameters	Vn	Vi	Sn	1/Sn	Wn	Vn-Vi	Sn-Vi	Vn-Vi/Sn-Vi	Qn=100(Vn-Vi)/(Sn-Vi)	Wn X Qn
1	pH	8.0	7	8.5	0.117	0.064	1	1.5	0.666	66.66	4.29
2	Dissolved Oxygen (mg/L)	4.5	14.6	6	0.166	0.091	-10.1	-8.6	1.174	117.44	10.71
3	Biological Oxygen Demand (mg/L)	3.2	0	2	0.5	0.273	3.2	2	1.6	160	43.80
4	Sulphates (mg/L)	42	0	200	0.005	0.0027	42	200	0.21	21	0.057
5	Nitrates mg/L)	4.5	0	45	0.022	0.0121	4.5	45	0.1	10	0.121
6	Chlorides (mg/L)	96	0	250	0.004	0.0021	96	250	0.384	38.4	0.0841
7	Fluoride (mg/L)	0.5	0	1	1	0.547	0.5	1	0.5	50	27.38
8	Alkalinity (mg/L)	86	0	200	0.005	0.0027	86	200	0.43	43	0.117
9	Total Hardness (mg/L)	144	0	300	0.003	0.0018	144	300	0.48	48	0.087
10	Total Dissolved Solids (mg/L)	282	0	500	0.002	0.0010	282	500	0.564	56.4	0.061
						$\sum W_n = 0.999$					$\sum W_n \times Q_n = 86.73$
<b>WQI = <math>\sum W_n \times Q_n / \sum W_n = 86.73 / 0.999 = 86.74</math></b>											

**Table 7: WQI Calculation of Khaksar Lake**

Sr. No	Parameters	Vn	Vi	Sn	1/Sn	Wn	Vn-Vi	Sn-Vi	Vn-Vi/Sn-Vi	Qn=100(Vn-Vi)/(Sn-Vi)	Wn X Qn
1	pH	7.9	7	8.5	0.117	0.064	0.9	1.5	0.6	60	3.86
2	Dissolved Oxygen (mg/L)	4.5	14.6	6	0.166	0.091	-10.1	-8.6	1.174	117.44	10.71
3	Biological Oxygen Demand (mg/L)	2.8	0	2	0.5	0.2738	2.8	2	1.4	140	38.33
4	Sulphates (mg/L)	28	0	200	0.005	0.0027	28	200	0.14	14	0.038
5	Nitrates mg/L)	5	0	45	0.022	0.012169	5	45	0.111	11.1	0.135
6	Chlorides (mg/L)	74	0	250	0.004	0.0021	74	250	0.296	29.6	0.064
7	Fluoride (mg/L)	0.4	0	1	1	0.547	0.4	1	0.4	40	21.90



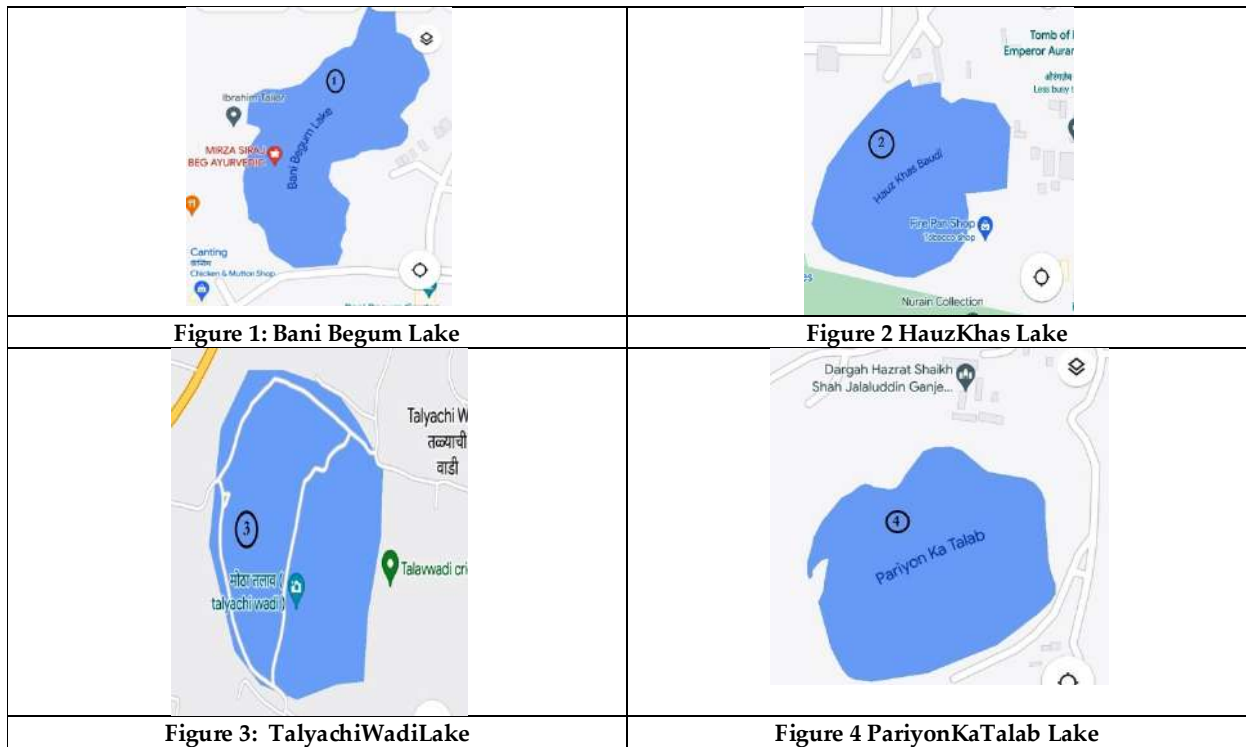


**Syed Yousuf Hussain**

8	Alkalinity (mg/L)	135	0	200	0.005	0.0027	135	200	0.675	67.5	0.184
9	Total Hardness (mg/L)	112	0	300	0.003	0.0018	112	300	0.373	37.3	0.068
10	Total Dissolved Solids (mg/L)	216	0	500	0.002	0.001	216	500	0.432	43.2	0.0473
							$\sum W_n = 0.999$				$\sum W_n \times Q_n = 73.35$
$WQI = \sum W_n \times Q_n / \sum W_n = 73.35 / 0.999 = 73.37$											

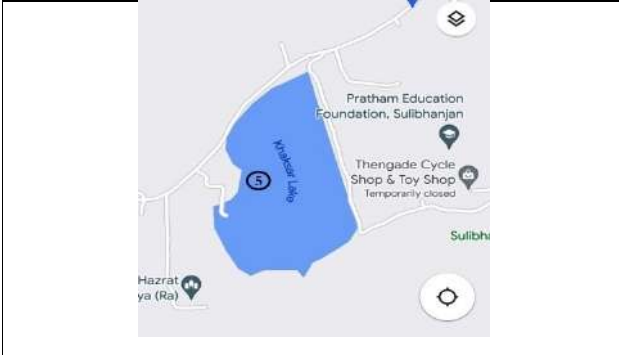
**Table 8: Water Quality Index & Status of Water Body**

Lake	Water Quality Index	Status Assigned
Bani Begum Lake	55.30	Poor
HauzKhas Lake	56.80	Poor
TalyachiWadi Lake	48.83	Good
PariyonKaTalab Lake	86.74	Very Poor
Khaksar Lake	73.37	Very Poor





**Syed Yousuf Hussain**



**Figure 5: Khaksar Lake**



**Figure 6: Khuldabad Town Map showing the lakes of study area**





## Breaking the Screen Spell: Over Coming Mobile Addiction

Satheesh Kumar .G<sup>1\*</sup>, M. Gunasri<sup>2</sup>, M. Harika<sup>2</sup>, N. Pooja<sup>2</sup>, M. Maheswari<sup>2</sup>, Harsha Vardhan. M<sup>2</sup>

<sup>1</sup>Professor, Department of Pharmaceutical Chemistry, Seven Hills College of Pharmacy (Autonomous), Tirupati- 517561, (Affiliated to Jawaharlal Nehru Technological University, Anantapur) Andhra Pradesh, India.

<sup>2</sup>B.Pharm Student, Department of Pharmacy, Seven Hills College of Pharmacy (Autonomous), Tirupati- 517561, (Affiliated to Jawaharlal Nehru Technological University, Anantapur) Andhra Pradesh, India.

Received: 22 Jan 2024

Revised: 09 Feb 2024

Accepted: 29 Apr 2024

### \*Address for Correspondence

**Satheesh Kumar .G**

Professor,

Department of Pharmaceutical Chemistry,

Seven Hills College of Pharmacy (Autonomous),

Tirupati- 517561, (Affiliated to Jawaharlal Nehru Technological University, Anantapur)

Andhra Pradesh, India.

Email: gskpharma11@gmail.com



This is an Open Access Journal / article distributed under the terms of the **Creative Commons Attribution License** (CC BY-NC-ND 3.0) which permits unrestricted use, distribution, and reproduction in any medium, provided the original work is properly cited. All rights reserved.

### ABSTRACT

Mobile phones or cell phones has become the icons for now a days. As the popularity increases usage of mobile phones increases. Mobile phone addiction is a significant concern in today`s digital age. It refers to excessive and compulsive use of mobile phones, which can negatively impact various aspects of life, including relationships, productivity, and mental health. Mobile phone addiction is often driven by factors like constant need for social validation, fear of missing out(FOMO), and the instant gratification provided by smartphones. It can lead to symptoms such as excessive screen time, neglecting real life relationships, and difficulty focusing on tasks. Research suggests that setting boundaries, practicing digital detox, and seeking support can help manage mobile phones addiction. As per the Mental Health Foundation in the United Kingdom, people with depression experiences an loss of interest, unhappy mood, feelings of guilt, appetite, poor concentration and low energy. One study clarified that men use phones for efficiency and practically while women like to show affection to their families using smart phones. The use of mobile phones has become important, particularly among the adults. This has led to psychological dependence on mobile phones, which leads to addiction. Excessive use of mobile phones mostly causes headaches, earache, warmth sensations and difficulty in concentrating. Mobile phones eliminate electromagnetic radiations that effects the human cerebrum and decreases melatonin release in body. The introduction of additional features like music, radio, internet etc., may be resulting in excessive use of smart phones. Excessive mobile phone use is associated with adverse consequences in different spheres of life and some subjects use it in dependent pattern.





**Keywords:** Mobile phone addiction, breaking of smartphone addiction, overcoming digital distractions, Strategies for reducing mobile phone addiction, Impact of excessive phone use, Coping with FOMO.

## INTRODUCTION

Communication via mobile phones has advanced rapidly. In recent years, there has been a noticeable increase in the use of mobile phones, which has raised concerns about the potential negative effects on sleep and drowsiness caused by exposure to blue light from these devices during late-night use. Demonstrating that using a cell phone late at night has a negative impact on sleep would highlight a significant and pervasive public health issue [1]. The use of mobile phones has become a commonplace aspect of daily life, and recent data reveals that there are currently more than five billion users of the Worldwide System for Mobile Communications, also known as GSM, network globally [GSM World, 2010]. Due to its endless application and the fact that the human brain only processes a portion of the radiofrequency (RF) electromagnetic fields (EMF) generated by mobile phones, there are now more opportunities for rational investigations into the potential negative effects on health. Among the medical conditions most extensively discussed in relation to mobile phones are sleep disturbances and excessive tiredness[2]. Due to advancements in technology, mobile phone usage has become essential for many people worldwide. This is especially true for younger generations, who find it especially useful as these devices can store and send records, accept calls, and store information. Due to this, there is now a psychological reliance on cell phones, which leads to addiction. It's thought that using a phone excessively might cause headaches, earaches, hot feelings, and can make it harder to focus on anything. Numerous studies have also revealed that the majority of smartphone users experience increased stress and sleep deprivation, which negatively affects their ability to think clearly and learn[3]. These days, some young adults frequently use their phones right before bed or even right after turning out the lights. This undesired tendency can lead to delayed sleep onset, lack of sleep, erratic sleep-wake cycles, poor quality of sleep, and increased daytime tiredness. Moreover, games and social media can cause hyperarousal before sleep. Numerous studies have shown that mood problems are linked to sleep difficulties, and that lack of sleep causes disorientation, anger, anxiety, and despair [4]. A person's sleep takes up nearly one-third of their waking hours. Sleep is a basic human necessity.

It is a reversible obviousness condition in which the brain and body are generated, fixed, and reestablished [5]. The use of mobile phones has increased dramatically over the past 15 years due to its convenience in both personal and professional settings for communication and connection. Mobile phones have been used for activities other than communication, such as gaming and music listening. Research has also demonstrated that using a mobile device for email and social networking has aided in reducing loneliness and increasing friendships. As a result, mobile phones are becoming an integral part of their user's lives[6]. Moreover, mobile phones have been utilized for managing serious mental problems and quitting smoking. However, there are drawbacks to using a phone excessively in terms of one's health. The use of mobile phones has been linked to a number of negative outcomes, such as the development of brain tumours, headaches, earaches, and warmth sensations; headaches; dizziness; fatigue; facial dermatitis; frustration; and musculoskeletal symptoms brought on by prolonged texting. Additionally, it has been hypothesized that electromagnetic radiations influence melatonin production and the sleep electroencephalogram. The frequency of traffic accidents has been linked to the use of mobile phones while driving. Nonetheless, a number of research conducted recently have concentrated on the psychological effects of cell phone use. According to a new prospective study, higher usage of mobile phones is linked to increased sleep disruptions in men and symptoms of depression in patients of either gender at the one-year follow-up. Furthermore, it's been reported that excessive mobile phone use has been linked to a decline in family dynamics since one member attends phone calls while ignoring the other during in-person conversations. Another recent study conducted in Japan with 94,777 teenagers revealed that using a mobile phone to make calls or send texts after dark was linked to sleep disturbances such as short sleep duration, subjectively poor sleep quality, excessive daytime sleepiness, and insomnia symptoms. Some academics have created questionnaires to evaluate problematic mobile use, the psychological effects of mobile use, and cell phone addiction in light of the overuse of mobile phones. Studies assessing mobile addiction have revealed that a subset of participants fit the





Satheesh Kumar *et al.*,

criteria for excessive usage as measured by financial cost and volume of use, issues with parents brought on by excessive use, dysfunction in the socio-occupational domain, psychological disengagement, and tolerance. Other research indicates that introverted, low-self-esteem teenagers make up the bulk of smartphone addictions. Additionally, disorders like text aphrenia which causes one to believe they have received a text or felt the device vibrate textiety which causes one to worry that they won't receive or send a text post-traumatic text disorder which causes physical and mental injuries related to texting and binge texting which involves sending numerous texts in an attempt to feel good about themselves and get responses have also been described by authors [7]. After China, India has the second-largest mobile phone user base, and its client base is growing more quickly than China's. Nevertheless, there are currently no comprehensive data available from India that assess the potential for misuse and dependence associated with mobile phone use. With the growing interest in behavioural addiction and the dearth of data from India, the current study set out to investigate the mobile phone usage patterns of young individuals pursuing postgraduate and graduation degrees. The secondary goal was to assess the negative effects of dependent pattern mobile phone use by evaluating their use of mobile phones using the CAGE Questionnaire and the International Classification of Diseases-10th Edition (ICD-10) Classification of Mental and Behavioural Disorders Criteria of Substance Dependency Syndrome [7].

It has been demonstrated that problematic social media use is limited to “fear of missing out” (FOMO). FOMO acted as a mediator in the relationships between problems and social use of smart phones and dread of both positive and negative evaluations. Participants with a 72hour smart phone access restriction rated withdrawal and FOMO higher than those without. A relationship was observed between the overview of smart phones and social communication. The associations between problematic smart phone use anxiety and depression were mediated by FOMO. Over use of smartphones has been linked to psychological stress and social comparisons on social media networks. While impulsivity, excessive reassurance seeking, but not extra version, have been linked to problematic smart phone usage in other studies, personality traits such consciousness, openness, emotional stability, and neuroticism have been linked to problematic smart phone use. teenagers who use their smart phones excessively report getting less sleep overall and of lower quality. Sleep disturbance acted as a mediator factor in the relationship between depression and media consumption before bed. Additionally there was correlation found between prolonged screen time and issues with insomnia, insufficient sleep, and difficulties start of sleep. Extended periods of problematic mobile use were associated with an increased risk of sleep disruptions and mental discomfort, which was lessened upon stopping use. Overuse of mobile phones has been linked to poor sleep patterns and quality. over use of smart phones has been linked to increased perceived stress and decreased sleep quality, as well as higher fat and reduced muscle mass. AACE increased ocular symptoms, headache complaints, headache duration and frequency in migraineurs are additional medical issues. Cervical disc degeneration was more common young patients with chronic neck discomfort who also used cellphones excessively. Lastly, the median narrow C cross sectional areas (CSAs) in the dominant hands off excessive smart phone uses were higher [8].

But lately, there has been a rise in the severity of smartphone addiction. Numerous studies have offered various types of study activities, such as new addiction measuring scales and the environmental overall personal variables that create the addiction to date, in an effort to avoid addiction and provide new instructional techniques for secondary school students. The current generation of mobile phones, known as smartphones, have been around for a while and have already taken over the market. With their numerous keyboards, smart phones are more than just phones; they can also be used as computers, with features like email, calendars, contact books, and office applications that can be read and edited. Multimedia phone capabilities like podcasting, sound recording, video, and camera are cutting edge and can rival specialized equipment. New software can be installed on a smart phone, and the selection of available apps is growing. Games, GPS features, and social media sites (such as Facebook, Instagram, WhatsApp, and Twitter) are particularly well-liked. Smartphones today give users, advertisers, and publishers the ability to interact more effectively and socialize while using this cutting-edge platform, all while maximizing the company's resources. The operating revenues and expenses are the main subjects of the income statement. Financial report users who need to make decisions need information about all aspects of availability that are simple to use [9]. However, smart phone addiction has become a more serious problem recently. In order to prevent the addiction and to provide new educational methods for the secondary school Students, many researchers have proposed





Satheesh Kumar *et al.*,

various kinds of research works such as new addiction measurement scales and the environmental or personal factors that cause the addiction so far. Smart phone is the new generation of mobile phones, they have emerged over the last few years and already have conquered the market. Smartphone with their mini keyboards are not just phones, but have computer functions as email, calendar and address book, and office programs for reading and editing. The multimedia phone features such as camera, video, sound recordings or podcasting is advanced and can compete with specialized equipment. Smart phone can be However, smart phone addiction has become a more serious problem recently. In order to prevent the addiction and to provide new educational methods for the secondary school Students, many researchers have proposed various kinds of research works such as new addiction measurement scales and the environmental or personal factors that cause the addiction so far. Smart phone is the new generation of mobile phones, they have emerged over the last few years and already have conquered the market. Smartphone with their mini keyboards are not just phones, but have computer functions as email, calendar and address book, and office programs for reading and editing. The multimedia phone features such as camera, video, sound recordings or podcasting is advanced and can compete with specialized equipment. Smart phone can be

## ADVANTAGES OF MOBILE PHONES

These days, we do nearly everything on our cell phones. The days of using them just for calls are long gone. Our lives now centre around it. They are used for voice, message, and mail communication. We may use our phones to browse the internet as well. Most notably, we use the camera on our mobile devices to take pictures and record videos [10]. These days, phones are referred to as smartphones. They are sometimes even more than a computer, and they are never less. Using this phone, you may handle your official documents and make video calls to other individuals. You have the opportunity to play music and use social media with it [10]. Furthermore, we observe how laptops and PCs have been supplanted by mobile phones. We use our cellphones for all of our tasks. To make our work easier, our phones can even be used to create PowerPoint presentations and serve as calculators [10].

## DISADVANTAGES OF MOBILE PHONES

Mobile phones have many advantages, but they also have a lot of drawbacks. They firstly put people at a distance from one another. People talk less to each other as they spend more time on their phones. Instead of interacting with one another, people will be glued to their phones while seated in the same room [10]. As a result, phones are a time waster. They readily divert people, who end up using their phones for hours at a time. The more they use smartphones, the dumber they get. Instead of working, they spend their time on their phones [10]. Most importantly, a lot of illnesses are brought on by cell phones. We lose vision when we use phones for extended periods of time. They make our brains work harder. In addition, we have headaches, teary eyes, insomnia, and other symptoms [10]. In addition, people's lives now lack privacy as a result of mobile phones. Your phone and social media stores all of your information, making it easily accessible to anybody. Hackers can exploit us. Additionally, cell phone bills are high. In addition to the fact that they are already pricey, we also purchase costly devices to improve our user experience [10]. In summary, we see how it may be both a blessing and a curse. How we use it to our advantage is up to us. We need to use our phones responsibly and resist allowing them to rule our lives. Our lives are becoming increasingly dominated by our phones, so we need to know when to say when. We are the proprietors, not the smartphone, after all [10].

### Effects of mobile phone addiction

Some effects of phone addiction include Muscle pain and stiffness, Fatigue, Blurry vision, Dry eyes, Red or irritated eyes, Auditory illusions (hearing your phone ring or vibrate when it's not), Thumb or wrist pain, Loss of interest in other activities you once enjoyed, Insomnia and sleep disturbances, Worsened school or work performance, Heightened conflicts with your social group or family, Feelings of irritability or unease when you don't have your phone, An increased risk of developing depression or anxiety, Putting yourself in dangerous situations by using







Satheesh Kumar *et al.*,

your phone when you shouldn't be, Feelings of guilt, helplessness, or loneliness when you go without your phone [11].

### Causes and Risk factors of mobile addiction

What makes someone get a phone addiction from using their smartphone in an uncontrollably usual manner? There are two problems. To begin with, applications and smart devices are intentionally made to make us addicted [12]. There are entire teams whose sole responsibility it is to draw our attention with psychological ploys. Ultimately, the prosperity of their enterprises hinges on our utilization of their merchandise. Because smartphones are intrinsically addictive, anyone can develop this compulsion even if they are not the type of person who becomes addicted to them. Alcohol functions similarly. Although not everyone who drinks will develop an alcohol addiction, alcohol is addictive in and of itself. The second aspect of phone addiction is conditioning, or modifications to your brain's neural architecture. The limbic region of the brain is where phone addiction first manifests [13]. The limbic system controls your basic fight-or-flight/freeze response in addition to your behaviour and emotional reactions. The limbic system can become locked into an excessive stress response pattern in reaction to stress or trauma. This implies that it develops a hypersensitive response to possible threats, perceiving danger where none actually exists. A person's subconscious believes that their smartphone has crucial information that they should check as soon as it "pings," since their brain has been trained to remain in this persistent state of anxiety. This idea incites the body's stress reaction, which gives rise to an insatiable need or impulse to check one's phone. The act of checking one's phone can provide a brief sense of relief or satisfaction for the person, but it ultimately contributes to reinforce the maladaptive practice. Now, whenever they give in to their hunger and check their phone, it serves as a reminder to their subconscious mind that they are acting appropriately. As a result, the next time their phone "pings," they will feel an even greater urge to check. This person is caught in a conditioned, maladaptive cycle of addiction that physically alters the brain's circuitry [14]. Although everyone can become entangled in this conditioned cycle, some risk factors [15] may make it more likely. The likelihood of being addicted to phones. Among them are: Having a mental health disorder, such as OCD, depression, or anxiety, already having a high chronic stress load, excessive alcohol use, social anxiety, going through stressful or traumatic life events, especially in quick succession, or having experienced trauma as a child.

### Symptoms of mobile phone addiction

The following are some indications that someone may be hooked to their phone: using it to pass the time when bored, using it most of the time, emotions such as agitation, melancholy, or anxiety when they are without their phone, unable to restrict the use of cell phones, problematic use in risky circumstances, loss of a relationship, frequent disruptions in professional, social, mental, physical, or familial life, The most recent edition of the Diagnostic and Statistical Manual of Mental illnesses (DSM-5-TR), the manual used by mental health professionals to diagnose illnesses, does not officially identify cell phone addiction as a condition in and of itself. On the other hand, a few characteristics of mobile phone addiction may share similarities with other behavioural addictions included in the DSM-5-TR [16].

### Impact on health

A sedentary lifestyle brought on by excessive mobile phone use can contribute to a number of health conditions, including obesity, cardiovascular disease, and musculoskeletal ailments. Long periods of time spent slumped over a phone can result in repetitive strain injuries, text neck, and neck and back pain. Mobile devices' blue light emissions have been shown to interfere with sleep cycles, make it more difficult to fall asleep, and lower the quality of sleep. Utilising a mobile device excessively before night might cause daytime sleepiness, lethargy, and insomnia. Addiction to mobile devices may cause or worsen conditions including stress, depression, and anxiety. Feelings of loneliness, isolation, and FOMO (fear of missing out) might increase if you're continuously checking your notifications and social media updates and feel the need to always be connected [17].



**Satheesh Kumar et al.,****HOW TO OVERCOME MOBILE PHONE ADDICTION**

Smartphones are widely accessible everywhere in the world. Globally, there are currently an astounding 3.3 billion smartphone users. Put differently, according to Statista (2019),[18] over one-third of all people on Earth have mobile access to the Internet. There is no denying that the widespread use of smartphones offers many benefits, such as simple information access, improved communication options, and navigational chances, to name a few. Several studies draw attention to the negative consequences of smartphone (over-)use in addition to these beneficial impacts (Elhai, Levine, Dvorak, & Hall, 2016; Elhai, Yang, & Montag, 2019; Gao, Xiang, Zhang, Zhang, & Mei, 2017; Gligor & Mozo's, 2019; Montag & Becker, 2019). Different routes are proposed by Billieux, Maurage, Lopez-Fernandez, Kuss, and Griffiths (2015)[19] to explain how problematic smartphone use develops (excessive reassurance route) as well as other unfavorable effects that may result from its use. Psychopathology (such as ADHD or antisocial personality) and personality (such as poor self-control or emotional instability) have been proposed as risk factors. Based on Kardefelt-Winterther's (2014) Compensatory Internet Use Theory, Hall (2019) created a theoretical framework that characterizes (problematic) smartphone use as a regulatory tactic to lessen negative feeling (anxiety). More complex theoretical frameworks are still lacking, though. Among the negative effects of smartphone (over-)use are issues with losing productivity due to frequent interruptions (Duke & Montag, 2017b),[21] being less focused on work-related tasks because of the mere "presence" of the smartphone on the work desk (Ward, Duke, Gneezy, & Bos, 2017)[22], and being inattentive to traffic due to smartphone interaction (Billieux, Maurage, et al., 2015). Furthermore, studies conducted by Hadar et al. (2017) and Kushelev, Proulx, and Dunn (2016) indicate that frequent usage of smartphones may cause symptoms similar to ADHD. It has been demonstrated that problematic smartphone use right before bed negatively impacts the quality of one's sleep. Consider leaving your phone in a different room to charge overnight rather than leaving it on your nightstand. Alternatively, if you like to use an audio book or meditation app to fall asleep, just putting your phone out of reach might be helpful.

**Reduce your notifications**

Managing an addictive behavior is often about reducing temptation, and there's nothing like the sound of an incoming notification to lure you back to your phone. You may not even realize just how many alerts you're getting during the day until you sit down and take stock. Try using your phone's Do Not Disturb function during certain hours, or turning off notifications for all but your most-used apps. This can be a powerful way to remind yourself that you're in control of your phone, not the other way around. Without being physically limited, wireless devices can access any digital information sources available on the Internet. However, up until recently, the wireless Internet was primarily restricted to text data, in contrast to the usual desktop Internet experience where users can browse through thousands of pages of graphic-rich information. There were three primary causes for this: First, there wasn't enough capacity available on wireless networks to send graphically complex graphics. Second, text data and small icons could only be displayed on the small screens of mobile phones and other handheld devices; third, the processing capacity of wireless devices was constrained. Accessibility to the Internet is, however, evolving quickly.

The work-enabling wireless LAN, the inter-device wireless connection of Bluetooth and infra-red, and cellular technology are currently the three main technology categories driving the development of the wireless Internet business. Network-centered third-generation (3G) is a cellular broadband technology that carries Internet, enhanced SMS, e-mail, and video-streaming. DoCoMo's i-Mode service in Tokyo was the first to commercially stream rich data into mobile phones; i-Mode phones have additional features like video cameras that let users make video calls and MP3 players that can stream music live from the Web; they are emailers, Web browsers, organizers, and, of course, phones. UMTS (3G) technology was commercially available in Europe in 2003/2004. The user will be able to access more information anywhere thanks to small-size display units, so the primary purpose of wireless Internet use should be to enable targeted searches, thereby meeting the user's immediate and specific information needs. Personalization seeks to obtain only pertinent information for the user by eliminating irrelevant information, based on a "user profile" that symbolizes the user's information needs (Citation Belkin and Croft).[26] Customization of services is made possible by the relatively modest level of customisation that Mobile Network Operators (MNO) and software businesses currently offer. This personalization is carried out by the user, not the system. Short Messaging Service (SMS), a feature found in practically all mobile phones, is the foundation for personalized services. The





Satheesh Kumar *et al.*,

degree of customisation is restricted to selecting from the available services, icons, and content links. Device Used by User. The information search is carried out by the user using an ITV browser, a PDA, or a cell phone. The gadget collects, stores, and forwards the current session's data to the server for examination. A WAP gateway allows PDA and cellular devices to connect to the server. The M3gate simulator, which simulates the device and its functionality on a PC, was used to design the user interface in WML. The ITV uses HTTP to establish a direct connection with the server and receives HTML query results. The PDA has the same capabilities. We used an Internet Explorer browser that was opened to full size and the screen resolution set to low to simulate the ITV. Considering earlier studies[27].

### Mobile addiction amongst teens

A cell phone provides an escape from the challenges and issues of everyday life. Every age group experiences smartphone addiction. However, adolescents are most likely to develop this addiction. Teenagers are in a period of life when they are learning and exploring new terrain. Their cell phones almost entirely contain all of the answers to the inquiries they have. Most parents these days are so busy with their jobs that they don't have the time to talk to or watch over their children, thus children these days have a lot of questions and things to offer but are frequently reluctant to discuss or speak about their parents or teachers. And secondly, there are numerous questions that individuals feel too ashamed to ask, which is why they turn to their cell phones for assistance. Additionally, people form acquaintances online and effectively communicate their emotions with others. Mobile phone addiction in teenagers can be highly dangerous. They are unable to concentrate on their studies because of their addiction, which interferes with their capacity to focus and weakens their comprehension of concepts. Mobile phone addicts are also more likely to start bad behaviours like drinking, smoking, and using drugs. Because they are constantly on their phones, they also lose their social skills. So, their future is still in jeopardy [28]. Teenage children shouldn't receive smartphones from their parent's, therefore parents must watch that. Teenagers must put first their education while pursuing their interests in a variety of constructive activities. Face-to-face communication has decreased between generations, and young people are less likely to chat to strangers. Even in places where they are prohibited, such as hospitals, legal proceedings and petrol-stations, everyone uses their phones. It is established that adolescent addiction to cell phones is linked to both physical and mental health issues. However, we cannot definitively state that problems with adolescents' poor mental or physical health are only attributable to their mobile phones. The study's reviewed articles revealed two distinct outcomes. There are two distinct schools of thinking that derive from this. According to one viewpoint, there is a direct correlation between cell phone addiction and psychological well-being. Teenagers' mental health is severely impacted by cell phone use; they may appear anxious, unhappy, or furious, or they may even consider suicide. In this day and age, the suicide rate is rising. Additionally, other research revealed a favorable correlation between physical health and cell phone addiction [29].

### Mobile phone addiction amongst older people

Mobile usage is also rising steadily among elderly adults. More phone use is associated with fewer face-to-face interactions and social interactions, increased feelings of loneliness and isolation, neglected relationships with family and friends, memory problems, impaired cognitive function, a sedentary lifestyle, sleep disturbances, and poor sleep quality. The negative effects of ageing on mental and physical health, including anxiety and despair, lower productivity, difficulties focusing on tasks, and financial consequences from excessive app and online purchase expenditure are just a few of the drawbacks that are observed in older people. produces fatigued eyes as well as potential vision issues [30]. Older folks are unaware of the widespread cybercrimes that target primarily the elderly in the current climate. a lack of environmental understanding raising questions about safety. Older folks are especially affected by the physical discomfort and agony caused by improper posture while using a mobile device. reduced capacity for deep discourse and meaningful connections, increased risk of sedentary behaviour and related health problems like obesity. Due to excessive phone use, some people may neglect their personal hygiene and self-care, which can have a severe influence on their memory and cognitive capacities, everyday functioning, sense of worth, and dependency on social media for external validation. Most mobile phone users over the age of 60 use them for alarms, reminders, calendars and sending image or voice calls [31].





Satheesh Kumar *et al.*,

### Mobile phone addiction among children`s

children with higher smart phone addiction rate of are likely to have problems with mental development such as emotional instability, depression, Attention Deficit Hyperactivity Disorder (ADHD), anger, and lack of attention. Because smart phones provide sensible and instant stimuli through visual sense and hearing sense, overuse of smart phones is likely to make children who are mentally premature, unstable. Smart phone itself is very playful and immersive, so when parents do not let them use it, children have higher chance of being depressed. Furthermore, it causes mental immaturity like aggressiveness and lack of attention. Smart phone addiction, similar to internet and game addiction, also bring results such as children's lack of attention and self-control. Higher smart phone addiction rate predicts problems in physical development such as impairments in visual/hearing senses, obesity, body imbalance same as game addiction of children. When you look at the screen light continually, it is bad for eye health of adults, but children are likely to have more severe impairment in visual sense. Also, when you use smart phone for a long time with earphones, bad effects on hearing sense are expected. When you are addicted to smart phones, you have lower chance of interacting with other people, and decrease in physical activities will increase the possibility to be obese. On top of that, operating small device with your hands for a long time might result in body imbalance. Children are incomplete in physical development yet, so overuse of smart phones will cause negative effects on children's physical development in many aspects [32].

### CONCLUSION

There are noticeably more detrimental psychological effects linked to mobile phone dependent patterns of excessive use. Therefore, it is imperative that the general public's understanding of this truth be raised. The use of mobile phones by the general public seriously compromises psychological and sleep quality. It demonstrates that the vast majority of people use their mobile phones every day for a variety of functions, including social media use, communication, watching films, and more. The user's heavy usage is mostly apparent during the late-night or overnight hours. There is a clear correlation between the amount of time spent on mobile phones and both insomnia and poor sleep quality. The effects extend well beyond restful sleep; they include weariness during the day and psychological ramifications. When used responsibly, a mobile phone can significantly enhance positive thinking, working memory, and overall performance, particularly for students seeking academic pursuits. It is concerning that there is a favourable association between depression and smartphone addiction. It is advisable to use smartphones in moderation, particularly for younger folks and less educated users who may be more susceptible to depression. The correlation between depression and smartphone addiction is a growing worldwide issue that demands additional research in this area in the future. The majority of learners in higher education use smartphones, and mobile phone usage is not distributed according on gender. Additionally, people use their phones more at night than in the morning. The amount of time invested using mobile phones varies across the people; it can range from a few minutes to several hours or even half of a day. All technology, including mobile phones, must be carefully used to improve everyday life without having a major negative impact on people's overall health in any way.

### ACKNOWLEDGEMENT

We thankful our principal and management of Seven Hills College of Pharmacy (Autonomous) for their constant support to write up an article for publication.

### REFERENCES

1. Loughran SP, McKenzie RJ, Jackson ML, Howard ME, Croft RJ. Individual difference in the effects of mobile phone exposure on human sleep: rethinking the problem. *Bioelectromagnetics*. 2011





**Satheesh Kumar et al.,**

2. H. G.J. K.S,C.VD,A.ALP ,William RF. A study of mobile phone usage on sleep disturbance, stress and academic performance among medical students in tamilnadu. International journal of community medicine and public health .2017
3. HE J-W,Tu Z-H, Xiao L, SuT, Tang Y-X effect of restricting bed time mobile phone use on sleep, arousal, mood and working memory: a randomised pilot trial .plos one .2020
4. Karadag M.Uyku Ile ILgili Tanimlar ve uyku Bozuklukularam siniflamasi. (internet). oct 2012.
5. Ritu Nehra, Natasha Kate, Sandeep Grover, Nitasha Khehra, Debasish Basu. Does the Excessive use of mobile phones in young adults reflect an emerging Behavioural Addiction
6. World Health Organization. The ICD – 10 classification of mental and behavioural disorders. Clinical descriptions and diagnostic guidelines. Geneva: WHO, 1992.
7. Yehuda Wacks, Aviv M. Weinstein\*. Excessive smartphone use is associated with Health Problems in Adolescents and Young Adults. 28 May 2021.
8. Ms. Monika, Y. & Mrs. Bhuvanewari, p. Assess the knowledge regarding smart phone usage among adolescent girls in Cheyyar. October 2017.
9. Uses and disadvantages of mobile phones for students and children
10. Angelica Bottaro. Phone addiction: What you need to know. October 18, 2023.
11. <https://www.businessinsider.com /facebook- has- been- deliberately- to- mimic- addictive- painkillers- 2018- 12.>
12. Rajmohan, V., & Mohandas, E. (2007). The limbic system. Indian journal of psychiatry, 49 (2), 132 – 139.
13. Horvath, J., Mundinger, C., Schmitgen, M. M., Wolf, N. D., Sambataro, F., Hirjak, D., Kubera, K. M., Koenig, J., & Christian Wolf, R. (2020). Structural and functional correlates of smartphones addiction. Addictive Behaviours, 105, 106334.
14. Ghosh, P. (2020). Smartphone addiction – A New Disorder or just a Hype. Clinical Psychiatry, 6(166)..
15. Hafidha Sulaiman AlBarashdi, Abdelmajid Bouazza, Naeema H. Jabur and Abdulqawi S. Al – Zubaidi. Smartphone Addiction Reasons and Solutions from the Perspective of Sultan Qaboos University Undergraduates: A qualitative Study. 2016 May 12.
16. Lin – Lin Yang, Chen Guo, Geng – Yin Li, Kai- peng Gan, Jin- Huan Luo. Mobile phone addiction and mental health: the roles of sleep quality and perceived social support. 22 September 2023.
17. Statista.com. (2019). Number of smartphone users worldwide from 2016 to 2021 (in billions). Retrieved October 15, 2019,
18. Billieux, J., Maurage, P., Lopez-Fernandez, O., Kuss, D. J., & Griffiths, M. D. (2015). Can disordered mobile phone use be considered a behavioral addiction? An update on current evidence and a comprehensive model for future research. Current Addiction Reports, 2(2), 156–162.
19. Billieux, J., Schimmenti, A., Khazaal, Y., Maurage, P., & Heeren, A. (2015). Are we overpathologizing everyday life? A tenable blueprint for behavioral addiction research. Journal of Behavioral Addictions, 4(3), 119–123.
20. Duke, É., & Montag, C. (2017b). Smartphone addiction, daily interruptions and self-reported productivity. Addictive Behaviors Reports, 6, 90–95.
21. Ward, A. F., Duke, K., Gneezy, A., & Bos, M. W. (2017). Brain drain: The mere presence of one's own smartphone reduces available cognitive capacity. Journal of the Association for Consumer Research, 2(2), 140–154.
22. Jiaxin Y. (2020). Association of problematic smartphone use with poor sleep quality, depression, and anxiety: A systematic review and meta-analysis.
23. Pera A. (2020). The psychology of addictive smartphone behavior in young adults: problematic use, social anxiety, and depressive stress.
24. Wacks Y, et al. (2021). Excessive smartphone use is associated with health problems in adolescents and young adults.
25. Belkin, N. J. and Croft, W. B. 1992. Information filtering and information retrieval: Two sides of the same coin. Communications of the ACM, 35 (12).





**Satheesh Kumar et al.,**

26. Goren-Bar, D. 2001. "Designing model-based intelligent dialogue systems". In *Information Modeling in the Next Millennium*, Edited by: Rossi, M. and Siau, K. pp. 271 – 287. Idea Group Publishing.
27. Sehar Shoukat. Cell phone addiction and psychological and physiological health in adolescents. 2019 Feb 4.
28. Alpana Vaidya, Vinayak Pathak, Ajay Vaidya. Mobile phone usage among youth. March 2016.
29. Ritu Nehra, Natasha Kate, Sandeep Grover. Does the excessive use of mobile phones in young adults reflect an emerging behavioral addiction? October 2012.
30. Helen Petrie & Jenny S. Darzentas. Older people's use of tablets and smartphones: A Review of research. 16 May 2017.
31. Jennifer Ihm. Social implications of children's smartphone addiction: The role of support networks and social engagement. 2018 June.





## Improving E-Learning Effectiveness Prediction Framework using Machine Learning Algorithms

R.Manimegalai<sup>1\*</sup> and R.Muralidharan<sup>2</sup>

<sup>1</sup>Assistant Professor, Department of Computer Science, Rathinam College of Arts and Science, (Affiliated to Bharathiar University), Coimbatore, Tamil Nadu, India.

<sup>2</sup>Principal, Department of Computer Science, E.S College of Arts and Science, Villupuram (Affiliated to Annamalai University), Tamil Nadu, India.

Received: 22 Jan 2024

Revised: 09 Feb 2024

Accepted: 27 Apr 2024

### \*Address for Correspondence

**R.Manimegalai**

Assistant Professor,

Department of Computer Science,

Rathinam College of Arts and Science,

(Affiliated to Bharathiar University),

Coimbatore, Tamil Nadu, India.

Email: mmegalai1981@gmail.com



This is an Open Access Journal / article distributed under the terms of the **Creative Commons Attribution License** (CC BY-NC-ND 3.0) which permits unrestricted use, distribution, and reproduction in any medium, provided the original work is properly cited. All rights reserved.

### ABSTRACT

A new approach for determining and evaluating the beneficial effects of e-learning strategies is the Action Categorization E-Learning Effectiveness (ACEE) prediction framework. To improve outcomes for learning in the current scenario of online education, it is crucial to identify the most beneficial teaching strategies. Based on their characteristics and instructional methodologies, e-learning actions can be categorized using the ACEE framework. Using Clustering or machine learning methods such as k-means, hierarchical clustering, or DBSCAN a predictive model can be generated by collecting necessary information on the learner characteristics, efficiency, and patterns of interaction. This methodology makes it feasible to determine the effectiveness of different e-learning actions and provides useful data for educational design. Teachers and educational designers can select and create effective e-learning measures through the validation and implementation of the framework, resulting in enhanced learning outcomes and improved student performance. The ACEE prediction framework proposes an opportunity for improving the development and implementation of e-learning, which will contribute to online learning.

**Keywords:** ACEE, Machine learning, Clustering, hierarchical clustering, or DBSCAN





## INTRODUCTION

The learning process is also an important factor in influencing student performance. Therefore, we fully consider the temporal features in the learning process and present a study that is aimed at predicting overall performance and student deficiency in mastering knowledge points based on certain assignment-related online behavior in MOOCs[1]. Among the various business models, online subscription-based learning platforms (e.g., Datacamp, Coursera, Lynda) are the most popular[2]. Clustering and classification methods to put students into different procrastination behavior categories based on their submission behavior[4]. An approach or technique used to evaluate and predict the effectiveness of e-learning initiatives or activities is the Action Categorization E-Learning Effectiveness (ACEE) prediction framework. It aims the level to which specific e-learning activities or methods of instruction can promote educational goals.

### The steps in the ACEE framework include

#### Action Categorization

In this step, different e-learning actions or measures are categorized according to their characteristics and teaching methods. For instance, several types of actions might be combined together, such as presentations with multimedia, interactive exercises, group discussions, quizzes, etc. Each action category may have unique characteristics and learning outcomes.

#### Data Collection

To evaluate the performance of e-learning tasks, relevant information is collected in this stage of the process. Data on the learner (such as characteristics and prior knowledge), performance (such as pre- and post-test scores, learning outcomes), and interaction (such as time spent on various activities, engagement levels) can all be included in this.

#### Model Development

A predictive model is created using the information collected to calculate the effectiveness of various e-learning activities. This model can be created using a variety of machine learning or clustering techniques, including regression analysis, decision trees, and neural networks. The relationship between the attributes of the e-learning actions and the relevant learning outcomes is taken in the model.

#### Model Validation

More information that is not utilized during the creation of the model are used to ensure the accuracy of the generated ACEE prediction model. This helps in evaluating the predictability and generalizability of the model. Prediction and recommendations: After the model has been validated, it may be used to forecast how well new or future e-learning initiatives will perform. The ACEE framework provides illumination on what actions are most likely to achieve particular learning objectives. On the basis of these hypotheses, suggestions can be made to improve the creation and dissemination of e-learning interventions.

## METHODOLOGY

### Action Categorization

Similar behaviors are categorized into groups based on an analysis of their attributes. To accomplish properly represent the underlying instructional practices and learning experiences, relevant and unique categories have to be established. Expert recommendations or machine learning techniques, including clustering algorithms that classify similar actions based on their attributes, are able to do this. The outcomes of the process of action categorization are then recorded and reported. This involves outlining each category in detail, providing definitions and examples of e-learning activities that corresponded to under each category. Within the ACEE framework, the documentation is used as a resource for future analysis and prediction tasks. Overall, action categorization is an important phase in the







### Manimegalai and Muralidharan

ACEE framework because it paves the way for further evaluation, planning, and recommendations on the effectiveness of e-learning initiatives. The ability to systematically understand and analyze the instructional strategies used for online learning enables researchers and practitioners, enabling them to make more knowledgeable decisions concerning both the creation and distribution of educational resources. Select the most appropriate clusters (K) for the e-learning dataset by determining the number of clusters. The most suitable amount of clusters can be determined using methods such as the silhouette analysis. According to the framework of the silhouette analysis, the silhouette coefficient is calculated for each data point to assess the overall quality of clustering outcomes. When compared to other clusters, the silhouette coefficient calculates how similar a data point is to its own cluster. It has a value between -1 and +1, with a higher number indicating more significant clustering. The following equation can be used to determine the silhouette coefficient for data point 'k':

$$\text{silhouette coefficient}(k) = (n(k) - m(k)) / \max(n(k), m(k))$$

The average distance between data point 'k' and all other data points in the same cluster is represented by the symbol 'n(k)', all other data points in the closest neighboring cluster is shown by the symbol 'm(k)'. To compute the average silhouette coefficient over all data points to determine the silhouette coefficient for the entire dataset. The scikit-learn library can be used to do silhouette analysis in e-learning data.

#### silhouette analysis involves the following steps:

- Implementing a clustering method, such as K-means, to assign data points to clusters.
- Calculating the average distance (n(k)) between every data point and every other point in a cluster.
- Calculating the average distance (m(k)) between every data point and every other point in the closest neighboring cluster.
- Using the equation above, determine the silhouette coefficient for each data point.
- Calculating the average silhouette coefficient over all the data.

Students' performance was evaluated using a number of criteria, such as course attendance, Assignment, quizzes in order to ensure the validity of the experiment on how they performed in the online learning environment. cumulative probability distribution of the 1,000 users' average grades. The number of active users is shown as a text annotation on the graph, which also has a threshold line. Graph showing students' participation in an online course, including: (a) the total number of students enrolled until the current date (b) the time students must allow for them to complete the course by the deadline.

## RESULTS AND DISCUSSION

The e-learning platform evaluates their knowledge for students based on how quickly they complete tasks. According to the amount of time spent in the E-learning system, selected clusters of student learning outcomes have been grouped. Based on the data, it can be assumed that most students finish their assignments in less than 25 minutes.

According to the analysis, 88.3% of students suggest that online education is beneficial for them. 15.7% of people have specific learning objectives, and 51.6% embrace these objectives and recognise the value of education. These indications unambiguously show that certain students have a clear understanding of the desired learning goals. There are certain students, nevertheless, who do not pay attention to how learning

#### Materials are studied

15.99% of people do not construct the educational route of the training plan, and 17.88% of people engage in secondary activities while learning. Figure shows that in order for online learning technology to be used effectively, students must be able to plan ahead, have clear objectives, and be motivated by themselves in online learning. Finally concluded that in online learning students' independent learning such as study material, learning goals, multimedia text, behaviour action such as interaction with teachers, e-mail communication to teachers, not interested students such as chatting, yawning frequently are clustered. A text resource is the most often used kind of resource since most students view text and frequently take notes on it. About 70% of learners look to multimedia materials first before performing the task; 50% Complete practical exercises online; 60% decide to review the course's learning objectives



**Manimegalai and Muralidharan**

before beginning it; More than 80% of students take their time learning at first and spend a lot of time on activities unrelated to school. The research revealed that while most students use text resources in addition to multimedia resources, they also strive to solve practical problems through learning environments with little regard for interactive involvement. Additionally, a lot of students engage in distracting activities while learning, like talking on the phone, listening to music, and more. In this regard accessing the e-learning the performance of students can be monitored through the behavior parameters such as facial recognition attendance system, interaction time to be calculated, time spent for activity completion.

**REFERENCES**

1. Qu, S., Li, K., Wu, B., Zhang, X. & Zhu, K. Predicting student performance and deficiency in mastering knowledge points in moocs using multi-task learning. *Entropy* 21, 1216. <https://doi.org/10.3390/e21121216> (2019)
2. Coussement, K., Phan, M., Caigny, A. D., Benoit, F. & D. & Raes, A.,. Predicting student dropout in subscription-based online learning environments: Te beneficial impact of the logit leaf model. *Decis. Support Syst.* 135, 113325. <https://doi.org/10.1016/j.dss.2020.113325> (2020).
3. Lei, Z. & Tong, D. Te prediction of academic achievement and analysis of group characteristics for mooc learners based on data mining. *Chongqing Higher Educ. Res.* 2, 1–13 (2021).
4. Hooshyar, D., Pedaste, M. & Yang, Y. Mining educational data to predict students' performance through procrastination behavior. *Entropy* 22, 12. <https://doi.org/10.3390/e22010012> (2020).
5. Wong B 2017 Learning analytics in higher education: an analysis of case studies. *Asian Association of Open Universities Journal* 12(1) 21 <https://doi.org/10.1108/AAOUJ-01-2017-0009>.
6. Estacio R and Raga Jr R C 2017 Analyzing students online learning behavior in blended courses using Moodle. *Asian Association of Open Universities Journal* 12(1) 52 <https://doi.org/10.1108/AAOUJ-01-2017-0016>.
7. Baharudin A, Sahabudin N and Kamaludin A 2017 Behavioral tracking in E-learning by using learning styles approach. *Indonesian Journal of Electrical Engineering and Computer Science* 8(1) 17 [doi:10.11591/ijeecs.v8.i1.pp17-26](https://doi.org/10.11591/ijeecs.v8.i1.pp17-26).
8. Amo Filva D, Alier Forment M, García-Penalvo F, Fonseca D and Casan Guerrero M 2018 Learning analytics to assess students' behavior with scratch through clickstream. *Learning Analytics Summer Institute Spain – LASI 2188* 74 <http://ceur-ws.org/Vol-2188/Paper8.pdf>
9. Filva D, Forment M, García-Penalvo F, Ecedero D and Casan M 2018 Clickstream for learning analytics to assess students' behavior with Scratch. *Future Generation Computer Systems* 93 673 [doi:10.1016/j.future.2018.10.057](https://doi.org/10.1016/j.future.2018.10.057).
10. Qu, S., Li, K., Wu, B., Zhang, X. & Zhu, K. Predicting student performance and deficiency in mastering knowledge points in moocs using multi-task learning. *Entropy* 21, 1216. <https://doi.org/10.3390/e21121216> (2019).
11. Shu, Y., Jiang, Q. & Zhao, W. Accurate alerting and prevention of online learning crisis: An empirical study of a model. *Dist. Educ. China* <https://doi.org/10.13541/j.cnki.chinade.2019.08.004> (2019).
12. Kokoç, M. & Altun, A. Effects of learner interaction with learning dashboards on academic performance in an e-learning environment. *Behav. Inf. Technol.* 40, 161–175. <https://doi.org/10.1080/0144929X.2019.1680731> (2021).
13. Binbin, Z., Lin, C. H. & Kwon, J. B. Te impact of learner-, instructor-, and course-level factors on online learning. *Comput. Educ.* <https://doi.org/10.1016/j.compedu.2020.103851> (2020).
14. Qureshi, M. A., Khaskheli, A., Qureshi, J. A., Raza, S. A. & Yousuf, S. Q. Factors affecting students' learning performance through collaborative learning and engagement. *Interact. Learn. Environ.* <https://doi.org/10.1080/10494820.2021.1884886> (2021).
15. Shen, X., Liu, M., Wu, J. & Dong, X. Towards a model for evaluating students' online learning behaviors and learning performance. *Dist. Educ. China* <https://doi.org/10.13541/j.cnki.chinade.2020.10.001> (2020).





**Manimegalai and Muralidharan**

16. Akram, A. et al. Predicting students’ academic procrastination in blended learning course using homework submission data. *IEEE Access* 7, 102487–102498. <https://doi.org/10.1109/access.2019.2930867> (2019).
17. Chaity, et al. Feature representations using the rectified linear unit (relu) activation. *Big Data Mining Anal.* 3, 20–38 (2020).
18. Madichetty, Sreenivasulu & Sridevi, M. Comparative study of statistical features to detect the target event during disaster. *Big Data Mining Anal.* 3, 39–48. <https://doi.org/10.26599/BDMA.2019.9020021> (2020).
19. Saha, S., Ghosh, M., Ghosh, S., Sen, S. & Sarkar, R. Feature selection for facial emotion recognition using cosine similarity-based harmony search algorithm. *Appl. Sci.* 10, 2816. <https://doi.org/10.3390/app10082816> (2020).
20. Zigeng, W., Xiao, S. & Rajasekaran R. Novel and efficient randomized algorithms for feature selection. *Big Data Mining Anal.* 3, 56–72. <https://doi.org/10.26599/BDMA.2020.9020005> (2020).
21. Chen, L. & Xia, M. A context-aware recommendation approach based on feature selection. *Appl. Intell.* <https://doi.org/10.1007/s10489-020-01835-9> (2020).
22. Huang, H., Lin, J., Wu, L., Fang, B. & Sun, F. Machine learning-based multi-modal information perception for soft robotic hands. *Tsinghua Science and Technology* 25, 255–269, (2019).
23. Qinchen, Cao & W., Zhang, Y. & Zhu J.,. Deep learning-based classification of the polar emotions of moe-style cartoon pictures. *Tsinghua Sci. Technol.* 26, 275–286 (2021).
24. Muhammad, M., Liu, Y., Sun, M. & Luan, H. Enriching the transfer learning with pre-trained lexicon embedding for low-resource neural machine translation. *Tsinghua Sci. Technol.* 26, 2 (2020)

**Table-1.Actions of Learning Objective**

Action	Instructional Strategy	Media Type	Interaction Mode	Learning Objective
Multimedia Presentation with Interactive Elements(M)	Presentation, Multimedia	Video, Slides	Self-paced, Interactive	Content Understanding
Discussion Forum for Collaborative Learning(D)	Collaborative Learning	Text, Images	Asynchronous, Discussion-based	Knowledge Sharing, Critical Thinking
Simulation-based Activity with Real-time Feedback(F)	Experiential Learning	Interactive Simulation	Self-paced, Interactive	Skill Development
Quizzes to Assess Knowledge(Q)	Assessment, Testing	Text, Multiple Choice Questions	Self-paced, Individual	Knowledge Assessment
Group Project with Peer Evaluation(P)	Cooperative Learning	Text, Documents	Synchronous, Collaboration	Teamwork, Problem Solving
Face Recognition Attendance System(A)	Multimedia	Image	Individual	Sincere, Dedication

**Table-2.Different Aspects of E-Learning Actions**

Different aspects of e-learning actions	Group-1	Group-2	Group-3
M	✓	✓	✓
D	X	✓	X
F	✓	X	✓
Q	✓	X	X
P	X	✓	✓
A	✓	✓	X

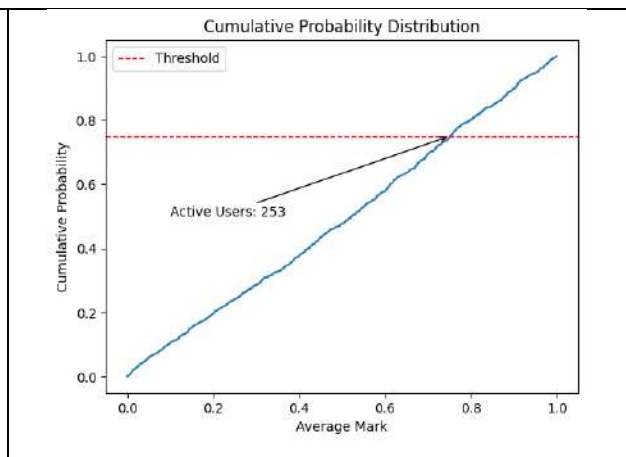
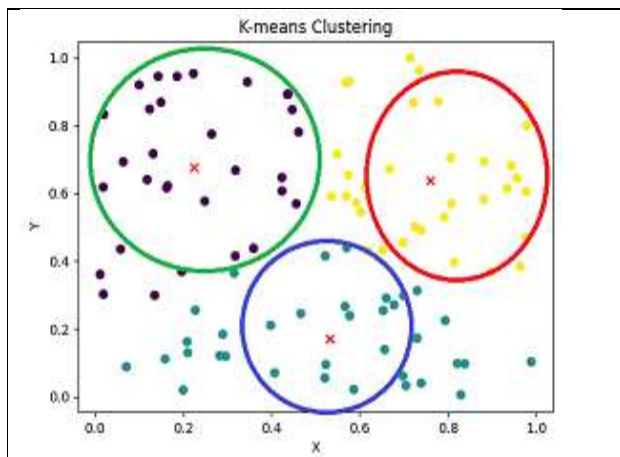




**Manimegalai and Muralidharan**

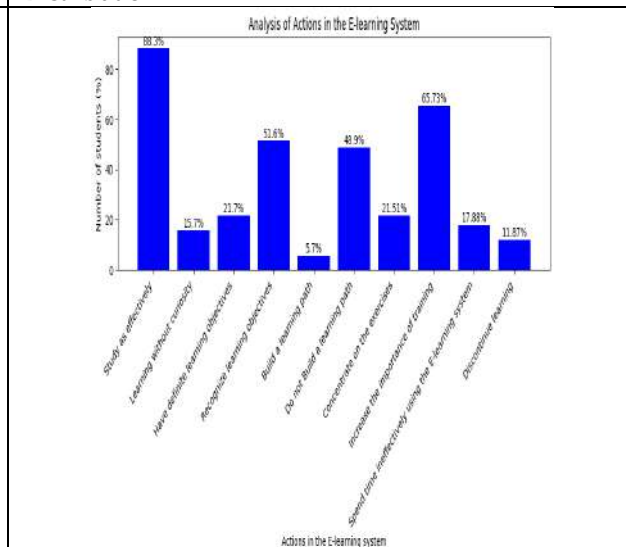
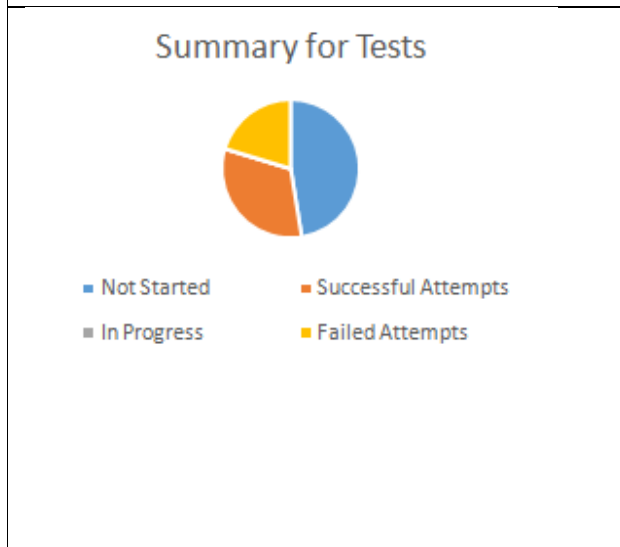
**Table-3. Evaluation of Learning Behaviors**

Aspects of the online learning system	Number of Learners(%)
Study as effectively	88.30
Learning without curiosity	15.7
Have definite learning objectives.	21.7
Recognize learning objectives	51.6
Build a learning path.	5.7
Do not Build a learning path	48.9
Concentrate on the exercises	21.51
Increase the importance of training	65.73
Spend time ineffectively using the E-learning system.	17.88
Discontinue learning	11.87



**Figure-1. Clustering the Students Online Activities**

**Figure-2. Active Users Cumulative Probability Distribution**



**Figure-3. Summary for Tests**

**Figure-4.Actions in the E-Learning System**





## UHPLC: An Advanced Chromatographic Development

Kad D.R.<sup>1\*</sup>, Taru P.<sup>2</sup> and Gadakh A.G.<sup>3</sup>

<sup>1</sup>Assistant Professor, Department of Pharmaceutical Chemistry, PES Modern College of Pharmacy (For Ladies) Moshi, (Affiliated to Savitribai Phule Pune University) Pune, Maharashtra, India.

<sup>2</sup>Assistant Professor, Department of Pharmacognosy, Vishwakarma Institute of Pharmacy, Kondhawa (Affiliated to Vishwakarma University) Pune, Maharashtra, India.

<sup>3</sup>Assistant Professor, Department of Pharmaceutics, PES Modern College of Pharmacy (For Ladies) Moshi, (Affiliated to Savitribai Phule Pune University) Pune, India.

Received: 23 Jan 2024

Revised: 09 Feb 2024

Accepted: 26 Apr 2024

### \*Address for Correspondence

**Kad D.R**

Assistant Professor,  
Department of Pharmaceutical Chemistry,  
PES Modern College of Pharmacy (For Ladies) Moshi,  
(Affiliated to Savitribai Phule Pune University)  
Pune, Maharashtra, India.  
Email: kad271192@gmail.com



This is an Open Access Journal / article distributed under the terms of the **Creative Commons Attribution License** (CC BY-NC-ND 3.0) which permits unrestricted use, distribution, and reproduction in any medium, provided the original work is properly cited. All rights reserved.

### ABSTRACT

The science of isolation, separation has made tremendous progress with the introduction of ultra-high-performance liquid chromatography (UHPLC), a completely new kind of liquid chromatography. UHPLC has emerged as the contemporary HPLC platform of choice in recent years. Because UHPLC requires less time for column equilibrate and analysis, it is the perfect tool for developing methods quickly. The constant development of packing material alterations that impact mixture separation has been the driving force behind the need for HPLC to become UHPLC. The less particle size increased the surface area of interaction that allows for a one-third shorter column length in UHPLC, which results in a increase in flow rate and a subsequent reduction in analysis time. Longer columns can be used more effectively for enhanced routine analysis of complicated samples due to UHPLC's greater pressure limitations. While UHPLC and HPLC have similar basic concepts and equipment designs, UHPLC is distinguished from HPLC by producing narrow peaks and having good spectral quality, which enable straightforward chemical identification in a range of analytical applications. This review offers UHPLC principle as well as its advantages and disadvantages.

**Keywords:** HPLC, Elution, Equilibration, Retention time, Pharmaceutical analysis





Kad et al.,

## INTRODUCTION

Chromatography is a technique that means Chroma: color, graph: writing which is used for separation that based upon various principles such as adsorption, partitioning, ion exchange, and others. (1) The separation of individual component from mixture is achieved by to dividing a mixture's components between a stationary phase and a mobile phase. It is a type of liquid chromatography in which stationary phase and mobile phase are liquid in nature. It is used for separation, isolation and purification of components from the mixture. The liquid stationary phase is packed in column on inert solid support. Ultra high pressure liquid chromatography is the process of forcing solvents through a column at high pressure. Due to its high pressure UHPLC employs a very minimal quantity of solvent as the mobile phase and has an amazingly quick analysis time. It also greatly improves the resolution of analyte mixtures and separation efficacy. In 2004, the first UHPLC systems were introduced. This HPLC modification's basic tenet is that efficiency increases with decreasing column packing particle size; a reduction in particle size of less than 2  $\mu\text{m}$  means that efficiency improves and does not decrease at greater linear velocities or flow rates. (2) It is used in the process of drug research and development, as well as to detect and quantify medicines in biological fluids and final dose forms.

## PRINCIPLE

The principle of HPLC and UHPLC is same that is partition. The components from mixture are separated on the basis of their partition coefficient. In the realm of physical sciences, the ratio of a compound's concentrations in a combination of two immiscible solvents at equilibrium is referred to as the partition coefficient or distribution coefficient. As a result, this ratio compares the solute's solubility in these two liquids. In UHPLC both stationary and mobile phase are liquid in nature, the analyte get distributed between both phases. Depending upon affinity of distribution in both phases analyte get separated. If the analyte having higher affinity in stationary phase it retained on stationary phase for longer time and get eluted last, while the analyte having less affinity in stationary phase get moved with mobile phase and separated firstly. For the separation or isolation of components, the mixture is loaded on column firstly. The mobile phase is passed under high pressure through column with the help of pump. Under influence of high pressure mobile phase components from mixture passes over stationary phase and depending on their difference in partition coefficient they get separate. (3) The van Deemeter equation, which explains the connection between flow rate and HETP or column efficiency, is also the foundation for this. (4)

$$H = A + B/v + Cv$$

Where,

A - Eddy diffusion,

B - Longitudinal diffusion

C - Equilibrium mass transfer

v - Flow rate

## INSTRUMENTATION OF UHPLC

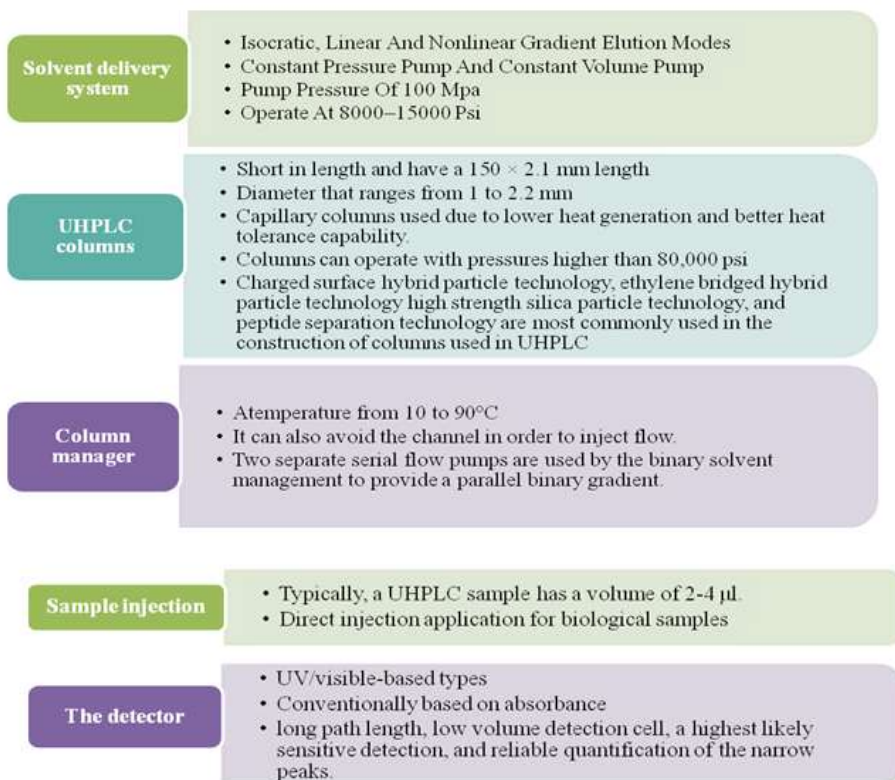
Description of UHPLC Instrumental components

Components for instrumentation of UHPLC are solvent delivery system which deliver the mobile phase at constant flow rate, UHPLC column which is heart of chromatographic instrument where actual separation takes place, column manager which manages overall required parameters, sample injections is to inject optimum quantity of sample onto the column, detector is for identification and quantification of sample components present in loaded sample. (6, 7, 8)





Kad et al.,



**TYPES OF COLUMNS USED IN UHPLC:** Acuity UHPLC columns are mainly used like charged surface hybrid, Ethylene-bridged hybrid, High strength silica, Peptide separation technology. (9, 10, 11)

#### Charged surface hybrid

Basic properties of the charged surface hybrid (CSH) C18 column, such as peak form and enhanced loading capacity, are mostly applicable to basic chemicals in the weak-ionic strength, low pH mobile phase. With a particle size of 1.7 µm, the hybrid charged surface maintains its low-level surface charge. Particularly employed in Acquity UHPLC CSH Phenyl-Hexyl columns, the poly aromatic compound selective straight-chain-alkyl also produces excellent peak shape at all pH levels. (11) There is good selectivity for polar compounds, positional isomers, and halogenated compounds with the Acquity UHPLC CSH Fluoro-Phenyl columns. Dipole-dipole, hydrogen-bonding, aromatic, and hydrophobic interactions are the causes of this.

#### Ethylene-bridged hybrid

To fully realize the potential speed, sensitivity, and resolution capabilities for the main generation methyl hybrid particle of xTerra columns, there must be a shortfall in mechanical strength or efficacy. A column containing a novel pressure-tolerant particle must be created. A novel, extra hybrid material column with an ethylene-bridged hybrid material was built up. In addition to UHPLC BEH phenyl columns, the developed ethylene-bridged hybrid (BEH) columns fixed polar group connected to the silyl functionality with a C6 alkyl. (10, 11)

#### High strength silica

High pore volume in UHPLC the mechanical stability required to withstand the high pressure inherent in UHPLC separations is not acquired by UHPLC particles. This requires the development of a unique silica particle with the proper morphology to provide a long-lasting and efficient UHPLC column at high pressure—probably 1000



**Kad et al.,**

pressures. The current automation is HSS particle technology; 1.8  $\mu\text{m}$  UHPLC HSS particles are made specifically for UHPLC separations. Acquity UHPLC HSS T3 columns were created to solve issues with retention and separation of tiny, polar, water-soluble organic compounds during reversed phase separation. (11) The non-end capped, low-coverage silica-based C18 chemistry used in the Acquity UHPLC HSS C18 selectivity for bases (SB) columns alternates selectivity for water-soluble substances influenced by silanophilic interactions.

### Peptide separation technology

For the purpose of analyzing peptides, various peptides were separated or isolated using peptide-based peptide separation technology columns. Peptide separation technology (PST) columns have been developed using C18 BEH Technology. PST column particles range are sizes from 1.7  $\mu\text{m}$  to 10  $\mu\text{m}$ , and column dimensions span from 50 to 250 mm in length and 75  $\mu\text{m}$  to 30 mm in internal diameter. (11) The PST columns show symmetrical peaks with crisp edges.

### ADVANTAGES OF UHPLC: (11)

- Cutting down on analysis time to make more products using the resources that are already available.
- Reduced the run time and boosts sensitivity.
- Related and unrelated molecules are quantified swiftly with fast resolving power.
- Preserves the performance of resolution.
- Gives the sensitivity, dynamic range, and selectivity of LC analysis.
- Less use of solvents.
- Really quick separations with excellent clarity.
- High-precision separations of intricate materials.
- Quick development of HPLC techniques that indicate stability.

### DISADVANTAGES OF UHPLC: (11)

- This type of column's life is shortened and requires more maintenance as a result of the higher pressure.
- Furthermore, phases shorter than 2 $\mu\text{m}$  are rarely used since they are often non-regenerable.

### APPLICATIONS OF UHPLC

Liquid chromatography is progressing thanks in large part to UHPLC. This is largely attributable to its capacity to deliver quick and accurate analysis. It can also be hyphenated using various tools that find use in vast fields including the food, toxicology, and pharmaceutical industries. It is useful in figuring out the nutritional content of particular food kinds. It was widely used in a variety of agricultural fields as well as in clinical analysis, where it is essential to boost throughput while lowering analysis costs. (12)

### Examination of herbal remedies

Despite the growing interest in herbal medications, there are few clinical usage studies assessing their safety and effectiveness using *in vivo* pharmacokinetic data of their primary constituents. These days, chromatographic fingerprinting of herbal components by UHPLC-MS is a potent and popular method. This is due to the possibility of it profiling herbal medicine samples' composition in a methodical manner. (13) Additionally, it offers superior separations and detection capabilities for active chemicals in extremely complex samples made from herbal treatments with a natural origin.

### Analysis of drugs in human plasma

To research a drug's pharmacokinetics, toxicity, and bioequivalency, it must first be found in biological samples. Sample preparation is the most important step in determining the presence of pharmaceuticals in biological samples (plasma, serum, urine, saliva, etc.). It frequently serves as a starting point for a dependable and quick method of improving analytical efficiency. Numerous proteins and other potentially disruptive substances are present in blood samples, which, if not removed, could interfere with the identification of analytes. In order to adequately recover





**Kad et al.,**

analyte from the biological sample matrices, protein precipitation, solid-phase extraction (SPE), and liquid-liquid extraction (LLE) have been widely used in sample preparation. The use of UHPLC for drug analysis in human plasma is a crucial component of therapeutic drug monitoring. Additionally, UHPLC has been used in the forensic industry. It examines substances of forensic significance found in human plasma. (14)

**Pharmacokinetics and bioavailability study**

For the quantitative evaluation and assessment of the pharmacokinetics and bioavailability of different medications, the UHPLC method has been developed and validated. This played a major role in guaranteeing the efficacy, safety, and quality of pharmaceuticals. Furthermore, as the majority of preclinical research is conducted on animals, using effective UHPLC techniques may result in significant reductions in the number of animals and chemical usage. (15) The investigation of the pharmacokinetics and bioavailability of herbal remedies can also benefit from UHPLC. The UHPLC-MS/MS method was created to identify the alkaloids in Uncaria. (16)

**Detection of impurities**

One of the most important steps in the drug development process is the identification of contaminants in the raw materials and finished products. Impurity profiling receives a lot of attention from regulatory bodies. If sufficient precautions are not followed in each step of the multi-step synthesis, the most common contaminants identified in every API are starting materials, intermediates, precursors, etc. (17) occasionally, during synthesis, contaminants from precursors and intermediates produce by products that are structurally similar. The UHPLC/MS method can be used at both high and low collision energies. All of the analytes in the sample are produced as precursor and product ions by the quick shift in collision energy, enabling quick impurity identification and profiling.

**Application in agricultural sector**

In the agricultural field, UHPLC has proven helpful for crop analysis, pesticide residue analysis, and soil component research. Animal products are included in agricultural products in addition to plant components. Therefore, before consuming such items, their safety and quality need to be investigated and guaranteed. (18)

**Food safety**

Ensuring the safety of food components and pollutants requires the availability of a robust analysis approach. Chromatography has gained recognition as one of the techniques used to detect and measure food pollutants over the last few decades. This innovative approach allows the separation, purification, and detection of components from a mixture for both qualitative and quantitative research. In an effort to increase food safety, UHPLC-MS has recently been used to estimate food contaminants and components. (19) UHPLC was used to quantify the important elements in human milk in order to determine how nursing mothers should consume their food.

**Quick evaluation of dosage forms**

Given the increasing mutation of disease-causing microbes and the increasing number of illnesses caused by human lifestyle choices, the pharmaceutical business faces significant pressure to boost productivity and quickly introduce new treatments to the market. The UHPLC system offers fast, isocratic, and gradient procedures for the accurate and repeatable analysis of pharmacological compounds in dosage forms. Consequently, this enhances the effectiveness of pharmaceutical manufacture. (20)

**Method development and validation**

For the aim of technique development and validation, UHPLC has been widely used. UHPLC improves chances for commercial success, lowers expenses, and increases efficiency—all of which are critical components of basic laboratory performance. (21) The time needed to develop and validate novel analytical methods can be significantly reduced by using UHPLC, which can shorten analysis times to as little as one minute and optimize methods in just one or two hours.





Kad et al.,

## CONCLUSION

UHPLC technique, which uses very high pressure and columns packed with sub-2  $\mu\text{m}$  particles, has shown to be an effective means of enhancing chromatographic analysis in terms of resolving power and throughput. Its intrinsic performance is particularly favourable when compared to other available methods, such as high temperature liquid chromatography or monoliths, for increasing chromatographic efficiencies in the 1,000–80,000 plate range.

## REFERENCES

1. Gumustas M, Kurbanoglu S, Uslu B, Ozkan SA. (2013) UPLC versus HPLC on drug analysis: Advantageous, applications and their validation parameters. *Chromatographia*. 76:1365-1427. DOI: 10.1007/s10337-013-2477-8
2. Chawla G, Ranjan C. (2016) Principle, instrumentation, and applications of UPLC: A novel technique of liquid chromatography. *Open Chemistry Journal*.;3 (1):1-16. DOI: 10.2174/1874842201603010001
3. Instrumental Methods of Chemical analysis; Chatwal G.R, Himalaya publishing House, pp-2.617
4. Instrumental analysis ;Skoog D.A, James Holler, pp-893
5. Klimczak I, Gliszczynska wiglo A. [2015] Comparison of UPLC and HPLC methods for determination of vitamin C. *Food Chemistry*.;175:100-105. DOI: 10.1016/j.foodchem.2014.11.104
6. Chesnut SM, Salisbury JJ. [2007] The role of UHPLC in pharmaceutical development. *Journal of Separation Science*.;30(8):1183-1190. DOI: 10.1002/jssc.200600505
7. Swartz ME.[ 2005] UPLC: An introduction and review. *Journal of Liquid Chromatography & Related Technologies*; 28:37-41. DOI: 10.1081/JLC-200053046
8. Goswami S. [2021] UPLC TM-A review on its recent advances in instrumental analysis UPLC TM-A review on its recent advances in instrumental analysis. *Indian Journal of Natural Sciences* ; 12(68):1-18
9. Chandraman K. [2016] An updated review on ultra performance liquid chromatography. *Analytical Chemistry: An Indian Journal*.;16(15):114
10. Shah K. [2014] Ultra performance liquid chromatography (Uplc): a modern chromatography technique. *Pharma Science Monitor*.;4(3):23
11. Walter, Thomas H., and Richard W. Andrews. [2014] "Recent innovations in UHPLC columns and instrumentation." *TrAC Trends in Analytical Chemistry* 63: 14-20.
12. Setyaningsih W, Palma M, Barroso CG. [2015] Comparison of HPLC and UPLC methods for the determination of melatonin in rice. In: Nesměřák K, editor. *Proceedings of the 11th Modern Analytical Chemistry*, Charles University in Prague, Faculty of Science, Czech Republic. pp. 170-175. DOI:10.13140/RG.2.1.2300.1687
13. Morais DR, Rotta EM, Sargi SC, Schmidt EM, Bonafe EG, Eberlin MN, Sawaya A.C.C.H.F and Visentainer J.[ 2015] Antioxidant activity, phenolics and UPLC-ESI(-)-MS of extracts from different tropical fruits parts and processed peels. *Food Research International* ;77:392–399.DOI: 10.1016/j.foodres..08.036
14. Jeong SH, Jang JH, Lee GY, Yang SJ, Cho HY, Lee YB. [2021] Simultaneous determination of fourteen components of Gumiganghwal-tang tablet in human plasma by UPLC-ESI-MS/MS and its application to pharmacokinetic study. *Journal of Pharmaceutical Analysis*.; 11(4):444-457. DOI: 10.1016/j.jpha.2020.08.003.
15. Chen L, Weng Q, Li F, Liu J, Zhang X, YZ.[ 2018] Pharmacokinetics and bioavailability study of Tubeimoside I in ICR mice by UPLC-MS/MS. *Acta Chromatographica*.;30(1):26-30. DOI: 10.1155/2018/9074893
16. Chen L, Ma J, Wang X, Zhang M. [2020] Simultaneous determination of six Uncaria alkaloids in mouse blood by UPLC-MS/MS and its application in pharmacokinetics and bioavailability. *BioMed Research International*.;2020:1030269
17. Davadra PM, Mepal VV, Jain MR, Joshi CG, Bapodra AH.[ 2011] A validated UPLC method for the determination of process-related impurities in azathioprine bulk drug. *Analytical Methods*.;3(1):198-204. DOI: 10.1039/c0ay00406e



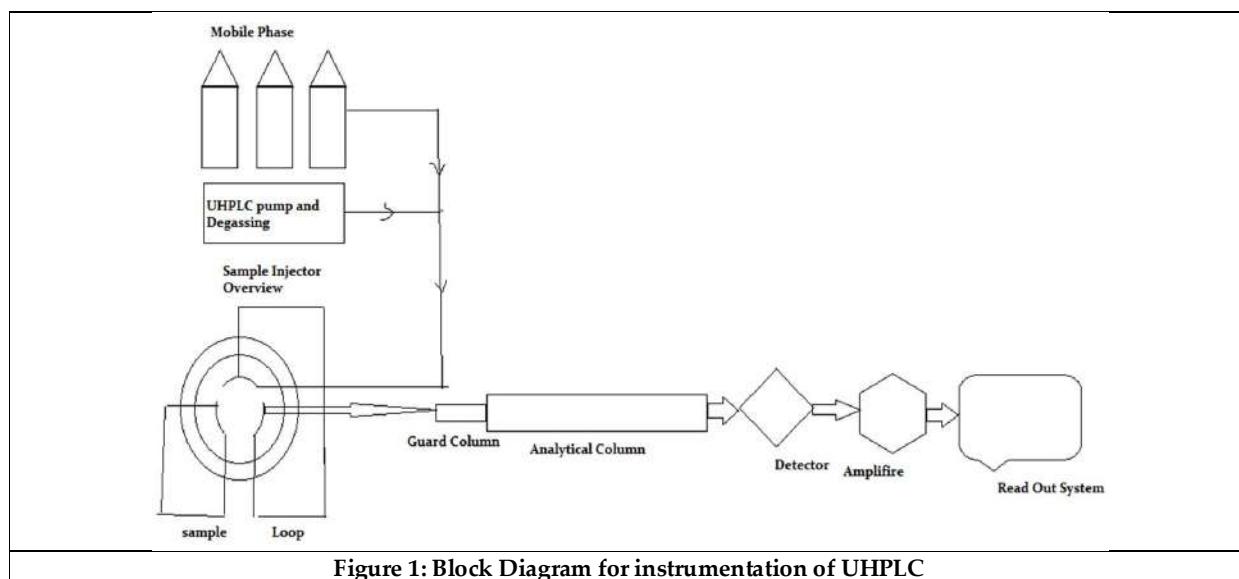


**Kad et al.,**

18. Zheng W, Fang ZL, Yu ZK, Yang WX, Qun XF. [2012] Determination of Tetracyclines and their Epimers in agricultural soil fertilized with swine manure by ultra-high-performance liquid chromatography tandem mass spectrometry. *Journal of Integrative Agriculture.*;11(7):1189-1198. DOI: 10.1016/S2095-3119(12)60114-2
19. Ashraf SA, Nazir S, Adnan M, Azad ZRAA.[ 2020] UPLC-MS: An emerging novel technology and its application in food safety. In: Srivastva AN, editor. *Analytical Chemistry-Advancement, Perspectives and Applications*. London, UK: IntechOpen;. DOI: 10.5772/intechopen.92455
20. Nassar AF, Wu T, Nassar SF, Wisniewski AV. [2017] UPLC–MS for metabolomics: a giant step forward in support of pharmaceutical research. *Drug Discovery Today.*;22(2):463-470. DOI: 10.1016/j.drudis.2016.11.020
21. Jena BR, Babu SM, Pradhan DP, Swain S. [2017] UPLC analytical method development and validation for the simultaneous estimation of paracetamol and caffeine capsules dosages form. *Pharmaceutical Regulatory Affairs.*;6(1):1-9. DOI: 10.4172/2167-7689.1000186

**Table 1: Difference between UHPLC and HPLC (5)**

Parameter	UHPLC	HPLC
Particle sizes of stationary phase	2 µm or less.	3-5 µm
Column	AQUITY UHPLC BEH C18 50x2.1mm	XTerra,C18, 50x4.6mm
Column dimensions	Internal diameters of 2.1 mm or less and is much shorter, 100 mm	Internal diameter of 4.6 mm and a length of 250 mm
Flow rates	0.2 – 0.7 ml/min	1-2 ml/min
Backpressure	Up to 1500 bar	Maximum pressures of 400-600 bar
Detection parameters	Sharp and Narrow peaks are produced with UHPLC	Less narrow as compared to UHPLC
Separation Time	Less	More as compared to UHPLC
Instrument Cost	More	Less
Total Run Time	1.5 min	10 min
Injection Volume	20ul	3-5 ul
Theoretical Plate Count	7500	2000





## Star Chromatic Index for Certain Graph Families

R. Sabitha<sup>1\*</sup> and V. Kowsalya<sup>2</sup>

<sup>1</sup>Ph.D Research Scholar, PG and Research Department of Mathematics, Sri Ramakrishna College of Arts and Science (Affiliated to Bharathiar University) Coimbatore, Tamil Nadu, India.

<sup>2</sup>Associate Professor, PG and Research Department of Mathematics, Sri Ramakrishna College of Arts and Science (Affiliated to Bharathiar University) Coimbatore, Tamil Nadu, India.

Received: 30 Jan 2024

Revised: 10 Feb 2024

Accepted: 27 Apr 2024

### \*Address for Correspondence

**R. Sabitha**

Ph.D Research Scholar,

PG and Research

Department of Mathematics,

Sri Ramakrishna College of Arts and Science

(Affiliated to Bharathiar University)

Coimbatore, Tamil Nadu, India.

Email: sabitha.r@srcas.ac.in



This is an Open Access Journal / article distributed under the terms of the **Creative Commons Attribution License** (CC BY-NC-ND 3.0) which permits unrestricted use, distribution, and reproduction in any medium, provided the original work is properly cited. All rights reserved.

### ABSTRACT

Graph coloring is a fundamental graph concept that is utilized in a wide variety of applications. Currently researchers are focusing on graph coloring which incorporates topics such as star coloring, prime coloring, face coloring and others. The purpose of graph coloring is to minimize the number of colors required to color the vertices in a graph such that they do not share the same color. In this disquisition we found the star chromatic index for families of book graph ( $B_m$ ), web graph ( $W_n$ ), antiprism graph ( $Q_n$ ), dipyramidal graph ( $DP_n$ ) and platonic graphs.

**Keywords:** Book Graph, Web Graph, Antiprism Graph, Dipyramidal Graph, Star Coloring, Star Chromatic Index.

**AMS Classification:** 05C07, 05C15, 05C76

### INTRODUCTION

Graph coloring is an underlying concept in graph theory: a branch of discrete mathematics that investigates the interactions between nodes or vertices connected by edges. The fundamental purpose of graph coloring is to assign colors to the vertices of a graph in such a way that no two adjacent vertices share the same color[1],[3]. The star chromatic number of a graph is given by  $\chi_s$  and provides the smallest number of colors required to adequately color the graph's vertices while ensuring that no two neighbouring vertices get the same color including the length of path





four which should not be bi-colored[5],[2],[6]. The purpose of this article was to investigate the star chromatic index for following graph families: Book Graph( $B_m$ ), Web Graph( $W_n$ ), Antiprism Graph( $Q_n$ ), Dipyramidal Graph( $DP_n$ ) and Platonic Graphs

## PRELIMINARIES

### Definition 2.1:Book Graph

The  $m$ -book graph is defined as  $B_m = S_{(m+1)} \square P_2$ , where  $S_m$  is a star graph and  $P_2$  is a path graph with two nodes. It is denoted by  $B_m$ [4]

### Definition 2.2:Web Graph

In the years 1980 and 2007, Koh et al and Gallian defined the Web Graph as a stacked prism graph  $Y_{(n+1,3)}$  with the edges of the outer cycle deleted. It is indicated by the symbol  $W_n$ .

### Definition 2.3:Antiprism Graph

An antiprism graph is a graph that corresponds to the skeleton of an antiprism. There are  $2n$  vertices and  $4n$  edges in the  $n$ -antiprism graph and it is indicated by  $Q_n$ .

### Definition 2.4:Star Coloring

A graph  $G$  is properly colored as a star if and only if no path in  $G$  is bicolored and has a length of three.

### Definition 2.5:Star Chromatic Index

The least number  $k$  for which an undirected graph  $G$  permits a star coloring with  $k$  colors is the Star Chromatic Index represented by  $\chi_s(G)$ .

## THEOREMS

### Theorem 1.1:

Let  $B_m$  be the book graph, then  $\chi_s[B_m] = 2\delta, \forall m \geq 2$

#### Proof

Let  $S_m$  and  $P_2$  create  $B_m$  the book graph with  $2n$  vertices and  $3n$  edges.

#### Case-(i): $m \equiv 0 \pmod{2}$

Let  $V[B_m] = \{v_i : 1 \leq i \leq \delta\} \cup \{u_i : 1 \leq i \leq m\} \cup \{w_i : 1 \leq i \leq m\}$

Define the mapping  $\sigma : V(B_m) \rightarrow c_i, 1 \leq i \leq 2\delta$  as follows:

- $\sigma(v_i) = \{c_1, c_2\}, 1 \leq i \leq \delta$
- $\sigma(u_i) = \{c_3, c_1\}, 1 \leq i \leq m$
- $\sigma(w_i) = \{c_4, c_1\}, 1 \leq i \leq m$

#### Case-(ii): $m \not\equiv 0 \pmod{2}$

Let  $V[B_m] = \{v_i : 1 \leq i \leq \delta\} \cup \{u_i : 1 \leq i \leq m-1\} \cup \{w_i : 1 \leq i \leq m+1\}$

Define the mapping  $\sigma : V(B_m) \rightarrow c_i, 1 \leq i \leq 2\delta$

- $\sigma(v_i) = \{c_1, c_2\}, 1 \leq i \leq \delta$
- $\sigma(u_i) = \{c_3, c_1\}, 1 \leq i \leq m-1$
- $\sigma(w_i) = \{c_4, c_1\}, 1 \leq i \leq m+1$

Suppose  $\chi_s[B_m] < 4$ , say 3. Let  $B_m$  contains  $m$ -rhombus at one edge  $\{v_1, v_2\}$  is colored with  $\{c_1, c_2\}$ . There exists  $m$ -square graph so we need two more colors for  $\{u_i\}$  and  $\{w_i\}$  where  $i$  is odd to complete the graph. Our assumption is contradictory. Hence  $\chi_s[B_m] = 2\delta$ .





**Sabitha and Kowsalya**

**Theorem 1.2:**

Let  $W_n$  be web graph  $\chi_s[W_n] = \Delta + \delta$  for  $3 \leq n \leq 6$

**Proof:**

Let  $V[W_n] = \{u_i: 1 \leq i \leq n\} \cup \{v_i: 1 \leq i \leq n\} \cup \{w_i: 1 \leq i \leq n\}$  be the vertices of web graph  $W_n$ .

Define the mapping  $\sigma: V(W_n) \rightarrow c_i, 1 \leq i \leq \Delta + \delta$  as follows:

**Case-(i):**  $n \equiv 0 \pmod 3$

$$\sigma(u_i) = \begin{cases} c_1, & i = 3n - 2 \\ c_2, & i = 3n - 1 \\ c_3, & i = 3n \end{cases}$$

$$\sigma(v_i) = \begin{cases} c_2, & i = 3n - 2 \\ c_4, & i = 3n - 1 \\ c_5, & i = 3n \end{cases}$$

and  $\sigma(w_i) = c_3$

Suppose  $\chi_s[W_n] < 5$ , say 4. Koh et al and Gallian defined the web graph as stacked prism graph with the deletion of outer edge, here denoted the vertices as  $\{w_i\}$  and  $\{u_i\}$  is colored with three colors. The prism graph is dual connected graph with connecting each nodes by an edge so we need two more colors to  $\{v_i\}$  and  $\{w_i\}$ . Similarly for Case-(ii) rearrange the colors as follows.

**Case-(ii):**  $n \not\equiv 0 \pmod 3$

$$\sigma(u_i) = \begin{cases} c_1, & i = 3n - 1 \\ c_2, & 2 < i < 4 \\ c_3, & 3 < i < 5 \\ c_4, & i = 1 \end{cases}$$

$$\sigma(u_i) = \begin{cases} c_1, & 3 < i < 5 \\ c_2, & i = 3n - 1 \\ c_3, & i = 1 \\ c_4, & 2 < i < 4 \end{cases}$$

and  $\sigma(w_i) = c_5$ . Hence,  $\chi_s[W_n] = \Delta + \delta$

**Theorem 1.3:**

The Star Chromatic Index for  $\chi_s[W_n] = \begin{cases} \Delta + \delta & n \equiv 0 \pmod 3 \\ \Delta + 2 & \text{otherwise} \end{cases} \forall n \geq 7$

**Proof:**

Let  $V[W_n] = \{u_i: 1 \leq i \leq n\} \cup \{v_i: 1 \leq i \leq n\} \cup \{w_i: 1 \leq i \leq n\}$  be the vertices of web graph  $W_n$ .

**Case-(i):**  $n \equiv 0 \pmod 3$

Define the mapping  $\sigma: V(W_n) \rightarrow c_i, 1 \leq i \leq \Delta + \delta$  as follows:

$$\sigma(u_i) = \begin{cases} c_1, & i = 3n - 2 \\ c_2, & i = 3n - 1 \\ c_3, & i = 3n \end{cases}$$

$$\sigma(v_i) = \begin{cases} c_2, & i = 3n - 2 \\ c_4, & i = 3n - 1 \\ c_5, & i = 3n \end{cases}$$

and  $\sigma(w_i) = c_3$

**Case-(ii):**  $n \not\equiv 0 \pmod 3$

Define the mapping  $\sigma: V(W_n) \rightarrow c_i, 1 \leq i \leq \Delta + 2$  as follows:

$$\sigma(u_i) = \begin{cases} c_1, & i = 3n - 1 \\ c_2, & i = 3n \\ c_3, & i = 3n + 1 \\ c_4, & i = 1 \end{cases}$$





**Sabitha and Kowsalya**

$$\sigma(v_i) = \begin{cases} c_2, & i = 3n - 1 \\ c_4, & i = 3n + 1 \\ c_5, & i = 3n \\ c_6, & i = 1 \end{cases}$$

$$\sigma(w_i) = \begin{cases} c_1, & i = 1 \\ c_3, & i = 3n - 1 \\ c_5, & i = 3n \\ c_6, & i = 3n + 1 \end{cases}$$

Similar to theorem 1.2. The prism graph is a dual linked graph with one edge linking each node. Hence  $\chi_s[W_n] = \begin{cases} \Delta + \delta & n \equiv 0 \pmod 3 \\ \Delta + 2 & \text{otherwise} \end{cases} \forall n \geq 7$

**Theorem 1.4:**

The Star Chromatic Index for  $\chi_s[AP_n] = \begin{cases} \Delta + 1 & n \equiv 0 \pmod 3 \\ \Delta + 2 & \text{otherwise} \end{cases} \forall n \geq 3$

**Proof:**

Let  $V[AP_n] = \{u_i: 1 \leq i \leq n\} \cup \{v_i: 1 \leq i \leq n\}$  be the vertices of  $AP_n$  and all vertices have same degree four (i.e.,)  $\Delta$ .

**Case-(i):  $n \equiv 0 \pmod 3$**

Define the mapping  $\sigma: V[AP_n] \rightarrow c_i, 1 \leq i \leq \Delta + 1$  as follows:

- $i \equiv 1 \pmod 3$ 
  - ✓  $c_1 \rightarrow 1 \leq u_i \leq n - 2$
  - ✓  $c_4 \rightarrow 1 \leq v_i \leq n - 2$
- $i \equiv 2 \pmod 3$ 
  - ✓  $c_2 \rightarrow 2 \leq u_i \leq n - 1$
  - ✓  $c_5 \rightarrow 2 \leq v_i \leq n - 1$
- $i \equiv 0 \pmod 3$ 
  - ✓  $c_3 \rightarrow 3 \leq u \leq n$
  - ✓  $c_6 \rightarrow 3 \leq v_i \leq n$

Suppose  $\chi_s[AP_n] = \Delta$ , say 4. An antiprism graph is a graph corresponding to the skeleton of an antiprism. Skeleton is a simplicial subcomplex of graph node that is connecting every node of all simplices of graph dimension. Our assumption is contradictory. So, five colors is adequate for  $n \equiv 0 \pmod 3$

**Case-(ii):  $n \not\equiv 0 \pmod 3$**

$$\sigma(u_i) = \begin{cases} c_1, & i = 3n - 1 \\ c_2, & i = 3n \\ c_3, & i = 3n + 1 \\ c_4, & i = 1 \end{cases}$$

$$\sigma(v_i) = \begin{cases} c_2, & i = 1 \\ c_4, & i = 3n \\ c_5, & i = 3n - 1 \\ c_6, & i = 3n + 1 \end{cases}$$

Similar to case-(i) need one more color to complete the graph. So, six colors is adequate for  $n \not\equiv 0 \pmod 3$

**Theorem 1.5:**

The star chromatic number  $\chi_s[DP_n] = 5 \ n \geq 7$

**Proof:**

Let  $V[DP_n] = \{v_i: 1 \leq i \leq n\} \cup \{u_i: 1 \leq i \leq 2\}$  be the vertices of dipyramidal graph

**Case-(i):  $m \equiv 0 \pmod 3$**

$$\sigma(v_i) = \begin{cases} c_1, & i \equiv 1 \pmod 3 \\ c_2, & i \equiv 2 \pmod 3 \\ c_3, & i \equiv 0 \pmod 3 \end{cases}$$

and

$$\sigma(u_i) = \begin{cases} c_4, & i = \text{even} \\ c_5, & i = \text{odd} \end{cases}$$

**Case-(ii):  $m \equiv 1 \pmod 3$**





**Sabitha and Kowsalya**

$$\sigma(v_i) = \begin{cases} c_1, & i \equiv 2 \pmod{3} \\ c_2, & i \equiv 0 \pmod{3} \\ c_3, & i \equiv 1 \pmod{3} \end{cases}$$

and

$$\sigma(u_i) = \begin{cases} c_4, & i = \text{even} \\ c_5, & i = \text{odd} \end{cases}$$

**Case-(iii):**  $m \equiv 2 \pmod{3}$

$$\sigma(v_i) = \begin{cases} c_1, & i \equiv 0 \pmod{3} \\ c_2, & i \equiv 1 \pmod{3} \\ c_3, & i \equiv 2 \pmod{3} \end{cases}$$

and

$$\sigma(u_i) = \begin{cases} c_4, & i = \text{even} \\ c_5, & i = \text{odd} \end{cases}$$

Suppose  $\chi_s[DP_n] < 5$ , say 4.  $DP_n$  skeleton of  $n$ -sided dipyramid made up of cycle graph and 2-empty graph. Here, we need five colors to complete the graph. Assumption is contradictory. Hence  $\chi_s[DP_n] = 5$   $n \geq 7$ .

**Theorem 1.6:** The star chromatic number  $\chi_s[DP_n]$  for  $n < 7$  is  $n + 1$ .

**Lemma 1.1:** The star chromatic number for platonic graphs

- $\chi_s$  for tetrahedral graph, cubical graph and dodecahedral graph is 4
- $\chi_s$  for octahedral graph and icosahedral graph is 5

## CONCLUSION

In this paper, we found star chromatic number of book graph, web graph, antiprism graph and dipyramidal graph families. In future, we can extend into some other graph families.

## REFERENCES

1. G. Fertin, A. Raspaud, B. Reed, On Star Coloring of graphs, Graphs Theoretic Concepts in Computer Science, 27th International Workshop, Springer Lecture Notes in Computer Science 2204, 2001, 140-153.
2. Gary Chartrand, Ping Zhang, Chromatic Graph Theory, 2019.
3. L. Jethruth Emelda Mary and Dr. K. Ameenal Bibi, A. Lydia Mary Julietterayan, A Study on Star Chromatic Number of Some Special Classes of Graphs, Global Journal of Pure and Applied Mathematics, Volume 13, Number 9 2017, pp.4569-4593. 7
4. Kavitha. B. N, Indrani Pramod Kelkar, Rajanna. K. R, Perfect Domination in Book Graph and Stacked Book Graph, International Journal of Mathematics Trends and Technology, Vol-56 Issue 7, 2017.
5. V. Kowsalya, R. Sabitha, Star Coloring of Book Graph and Ladder Graph, International Journal of Mathematics Trends and Technology, Volume 68 Issue 4, 102-106, April 2022.
6. Yang H, Naeem M, Qaisar S, On the P3 Coloring of Graphs, Symmetry, Volume 15(2):521, 2023. <https://doi.org/10.3390/sym1502052>
7. <https://orcid.org/0000-0002-3692-8033>
8. <https://orcid.org/0000-0003-0395-5542>







## Analyse the Antioxidant Content of *Centella asiatica*, *Cynodon dactylon* and *Cymbopogon flexuosus* (Krishna)

Rajesh Kumar Sinha<sup>1\*</sup> and Pawan Kumar Jain<sup>2</sup>

<sup>1</sup>Research Scholar, Department of Botany, School of Basic & Applied Sciences, Eklavya University, Damoh, Madhya Pradesh, India.

<sup>2</sup>Vice chancellor, Department of Botany, School of Basic & Applied Sciences, Eklavya University, Damoh, Madhya Pradesh, India.

Received: 22 Jan 2024

Revised: 09 Feb 2024

Accepted: 29 Apr 2024

### \*Address for Correspondence

**Rajesh Kumar Sinha**

Research Scholar,  
Department of Botany,  
School of Basic & Applied Sciences,  
Eklavya University,  
Damoh, Madhya Pradesh, India.  
Email: rajeshsinha48@gmail.com



This is an Open Access Journal / article distributed under the terms of the **Creative Commons Attribution License** (CC BY-NC-ND 3.0) which permits unrestricted use, distribution, and reproduction in any medium, provided the original work is properly cited. All rights reserved.

### ABSTRACT

The antioxidant potential of therapeutic plant-derived natural substances is a rapidly growing field of study. *Centella asiatica*(CA), *Cynodon dactylon*(CD), and *Cymbopogon flexuosus*(krishna)(CF) are just a few of the many plant species that have gained popularity due to their many medicinal uses, one of which is antioxidant activity. Examining the complex network that may contribute to the health-promoting benefits of these three botanical entities, this investigation seeks to dive into their antioxidant content.

**Keywords:** *Centella asiatica*, *Cynodon dactylon*, and *Cymbopogon flexuosus*(krishna), Antioxidant,

### INTRODUCTION

*Centella asiatica*, *Cynodon dactylon*, and *Cymbopogon flexuosus*(krishna) are three botanical entities known for their various pharmacological characteristics. [1,2] This work aims to completely investigate their antioxidant content. *Centella asiatica*, or *Gotu Kola*, is said to have antioxidant capabilities because of the asiaticoside, flavonoids, and triterpenoid saponins it contains. It also has a long and storied traditional history. In order to better understand the antioxidant processes that contribute to its neuroprotective properties, the project is aiming to quantify these molecules. [3,4] One hardy grass species that has a long medical history is *Cynodon dactylon*, more commonly known as *Bermuda grass*. Its antioxidant content has not been investigated yet, despite its known anti-inflammatory and diuretic effects. [5,6] This research will identify the precise chemicals in *Cynodon dactylon* that have free radical-



**Rajesh Kumar Sinha and Pawan Kumar Jain**

quenching actions by analysing its alkaloids, flavonoids, and tannins, which may provide the plant antioxidant properties. [7,8] East Indian Lemongrass, or *Cymbopogon flexuosus*(*krishna*), is known for its fragrant properties and may have antioxidant properties due to the presence of essential oils such as geraniol, limonene, and citronella. [9,10]. The study is focused on doing a thorough analysis of its antioxidant content, determining the makeup of volatile chemicals, and investigating potential therapeutic uses, especially for illnesses connected to oxidative stress. [11,12]. This work aims to improve our understanding of the antioxidant capabilities of these botanicals by combining traditional knowledge with scientific investigation. [13,14]. It might have applications in pharmaceuticals, nutraceuticals, and cosmeceuticals. Ultimately, it helps us understand how medicinal plants work to treat diseases caused by oxidative stress by revealing the molecular pathways involved.[15]

**METHODOLOGY**

"We obtained the fresh aerial parts of three different plant species from the lush fields of Ambikapur, which is situated in the tranquil Surguja district of Chhattisgarh: *Cymbopogon flexuosus*, also called *Krishna*; *Centella asiatica*, also called *Brahmi*; and *Cynodon dactylon*, also called *Doob Grass*. These carefully chosen plant materials would function as the basic components of the research we have planned. After gathering these essential materials, we started getting them ready for the next study. To preserve their original essence and characteristics, the leaves of these plants were carefully allowed to air dry. Then, to make sure the dried leaves were prepared for use in our scientific endeavors, they were ground into a fine powder. We took the precaution of keeping our powdered samples in an airtight container to protect their efficacy and integrity. Until it was needed for our scientific research, the plant material was kept in its perfect condition in this hermetically sealed container that acted as a protective vault. The integrity and dependability of our study materials were preserved in large part by this careful management of our botanical resources." The first phase was carefully inspecting the plant samples taken from *Cymbopogon flexuosus* (*Krishna*), *Centella asiatica*, and *Cynodon dactylon* for any indications of infection, spores, damage, discoloration, or deformation. After that, unharmed leaf samples underwent a comprehensive cleaning procedure that included rinsing with deionized water after being washed with tap water. The leaves were then meticulously air-dried at 37°C in a room with ambient conditions. To make the leaves ready for further examination, the midribs were cut off. The fruit and leaves were carefully crushed using a crusher and pestle in order to extract the advantageous chemicals. The four samples were then mixed with deionized water, keeping the specimen-to-deionized water ratio at 1:5, after being taken from several *Ficus religiosa* trees.

**Antioxidants Analysis**

Evaluating the antioxidant capacity of plant extracts is an essential part of scientific study, and the technique we used was the well-respected DPPH (2,2-diphenyl-1-picrylhydrazyl) method, which was carefully described by Kapoor et al. in their 2003 paper. The assessment of antioxidants in plant materials is essential because these substances may scavenge free radicals and reduce oxidative stress, which may have positive health effects.

**DPPH Scavenging Assay**

In a 96-well plate, 0.1 ml of a 0.1 mM DPPH solution was mixed with 5 µl of various concentrations of the test chemical ranging from 0 µg/ml to 2500 µg/ml. In triplicate, the reaction was set up and blanks were made using 0.2 ml of DMSO/Methanol and 5 µl of chemical at varying doses ranging from 0 µg/ml to 2500 µg/ml. Half an hour was spent in darkness incubating the plate. After the incubation period ended, a micro plate reader (iMark, BioRad) was used to measure the decolorization at 495 nm. As a control, the reaction mixture was given 20µl of deionized water. The scavenging activity was expressed as the percentage of inhibition relative to the control. We used Graph Pad Prism 6 software to determine the IC-50.



**Rajesh Kumar Sinha and Pawan Kumar Jain****Statistical Analysis**

Every experiment's data was run via a one-way analysis of variance (ANOVA), which was followed by post hoc analysis. The Bonferroni post hoc test is used after the two-way ANOVA and Tukey's multiple comparison test. Software called Graph Pad Prism 6.0 was used to do the analysis.

**RESULT**

For several materials tested in an antioxidant experiment, the supplied table shows the IC<sub>50</sub> values, which are the concentrations at which 50% inhibition occurs. The powerful capacity of Ascorbic Acid to neutralise free radicals is shown by its very low IC<sub>50</sub> value of 4.948 µg/ml. When compared to Ascorbic Acid, *Cymbopogon flexuosus(krishna)* demonstrates antioxidant action, although its substantially lesser efficacy is shown by its higher IC<sub>50</sub> value of 81.11 µg/ml. (*Cynodon dactylon*) CD and (*Centella asiatica*) CA have much higher IC<sub>50</sub> values of 330.7 µg/ml and 91.78 µg/ml, respectively, suggesting that they may not be as effective as Ascorbic Acid and CF (*Cymbopogon flexuosus(krishna)*) in suppressing free radicals. Furthermore, the percentage representation of (*Cymbopogon flexuosus(krishna)*) CF (Oil) (47.21%), rather than its absolute concentration, implies an inhibitory proportion. You can learn a lot about the samples' antioxidant properties and how good they are at scavenging free radicals from these IC<sub>50</sub> values. A reference sample was used at different concentrations to perform the DPPH scavenging experiment. You can see the mean, standard deviation, number of observations (N), and standard error of the mean (SEM) for each concentration in the table. The mean DPPH scavenging activity was determined to be almost zero (-3.5E-15) at a concentration of zero, with a standard deviation of 1.218652 and a standard error of 0.609326. At this concentration, the scavenging activity is either baseline or very small. An upward trend in DPPH scavenging activity was discernible as the concentration rose. The mean value reached 82.83582 at higher concentrations, such as 50, indicating a significant scavenging effect. Learn more about the measurement accuracy and variability at each concentration from the corresponding standard deviation and standard error of the mean (SEM) data. A thorough synopsis of the standard sample's DPPH scavenging activity at various concentrations is given in the statistical report. This data provides the foundation for comprehending the standard's efficacy in DPPH radical neutralisation and the dose-response relationship. The mean DPPH scavenging activity was almost nil at a concentration of zero (3.86E-15), suggesting that there was limited baseline scavenging activity.

The ability to scavenge DPPH became more apparent when the concentration was raised. The mean value reached 77.3386 at higher concentrations, such as 2500.0, indicating a significant scavenging effect. The accuracy and variability of the observations at each concentration may be understood by looking at the standard deviation (SD) and standard error of the mean (SEM) numbers that are connected with them. A thorough comprehension of the dose-response relationship and the efficacy of CF (*Cymbopogon flexuosus(krishna)*) in neutralising DPPH radicals may be gained from the statistical summary. Statistical analysis of *Cynodon dactylon* DPPH scavenging test results at various doses reveals interesting information about its antioxidant capacity. The mean DPPH scavenging activity of CD at the baseline concentration of 0.0 is 1.48E-14, suggesting that it has a limited intrinsic antioxidant action. Nevertheless, a steady rise in average values is seen as the concentration of CD (*Cynodon dactylon*) rises. The dispersion or variability of the DPPH scavenging activity around the mean may be understood from the standard deviation (SD) data. The low standard deviation (2.83849) for doses of 0.0 and 250.0 suggests that the replicates are somewhat consistent with one another. The observed antioxidant responses are more variable at doses like 50.0 and 2500.0, where the SD values are similarly raised, indicating larger mean values. In addition, the SEM shows how accurate the calculated mean is, which is a useful supplement. When the SEM is smaller, as it is with concentrations of 0.0 and 1250.0, it indicates that the mean values are more accurately predicted. All things considered, the results of the DPPH scavenging experiment show that the antioxidant action of CD (*Cynodon dactylon*) is concentration dependent, meaning that its effectiveness increases with increasing concentration. The observed antioxidant responses at varied concentrations of CD (*Cynodon dactylon*) were consistent and reliable, as shown by the standard deviation and standard error values, which give further context. *Centella asiatica* antioxidant capability at various doses is made possible by the DPPH (2,2-diphenyl-1-picrylhydrazyl) scavenging test. With a mean DPPH scavenging activity of 0,



**Rajesh Kumar Sinha and Pawan Kumar Jain**

CA shows very little intrinsic antioxidant activity at the baseline concentration of 0.0. There is a concentration-dependent rise in mean values as the CA (*Centella asiatica*) concentration increases. Data points regarding DPPH scavenging activity may be better understood by looking at their standard deviation (SD) values, which reveal how dispersed or variable they are around the mean. The observed antioxidant responses seem to be more variable when the SD values are higher, particularly at doses like 10.0 and 2500.0. This variation may be caused by the compound's sensitivity to variations in concentration or by intrinsic assay fluctuations. You can learn a lot about how accurate the calculated mean is from the SEM numbers. There is more faith in the correctness of the mean values at concentrations of 0.0 and 250.0 since the SEM values are lower at these positions. In conclusion, the results show that the antioxidant effect of CA(*Centella asiatica*) in the DPPH scavenging experiment is concentration dependent, with higher concentrations showing greater efficiency. The observed antioxidant reactions at varied doses of CA(*Centella asiatica*) may be better understood by examining the variable SD and SEM values, which provide insight into their consistency and dependability. Important statistical information on the antioxidant activity of *Cymbopogon flexuosus(krishna)*(oil form) at various doses may be derived from the DPPH (2,2-diphenyl-1-picrylhydrazyl) scavenging experiment. The mean DPPH scavenging activity of CF-oil is 0, suggesting low intrinsic antioxidant action, at a baseline concentration of 0.0. There is a concentration-dependent rise in mean values as the CF-oil(*Cymbopogon flexuosus(krishna)*)concentration increases. The dispersion of the DPPH scavenging activity data points around the mean is shown by the standard deviation (SD) values. The observed antioxidant responses seem to be more variable when the SD values are higher, particularly at doses like 3.1 and 50.0. The compound's susceptibility to variations in concentration or other variables impacting the test might be the cause of this fluctuation. You can learn a lot about how accurate the calculated mean is from the SEM numbers. At concentrations of 0.0 and 25.0, lower SEM values indicate a better degree of confidence in the correctness of the mean values. In conclusion, the results show that the antioxidant effect of CF(*Cymbopogon flexuosus (krishna)*-oil in the DPPH scavenging experiment is concentration dependent, with an increase in effectiveness with increasing concentration. Understanding the dependability and consistency of the observed antioxidant reactions at varied CF-oil (*Cymbopogon flexuosus(krishna)*)concentrations is helped by the variable SD and SEM values.

**CONCLUSION**

We tested the antioxidant capabilities of *Cymbopogon flexuosus(krishna)*(CF), *Centella asiatica* (CA), and *Cynodon dactylon* (CD) extracts using the 2,2-diphenyl-1-picrylhydrazyl (DPPH) technique. The aim was to find out whether these plants, which have a wide variety of phytochemical profiles and are recognized for their traditional applications, had significant antioxidant activity. Antioxidant activity was shown to be greatest in the *Cynodon dactylon* extract, according to the data. The particular phytochemical makeup of CD(*Cynodon dactylon*), which includes alkaloids, flavonoids, and tannins, is responsible for its powerful free radical-scavenging activity. The ingredients include hyaluronic acid and a water-based *Cymbopogon* species extract. A water-based extract of *Centella asiatica* (L) leaves was shown to include tannins and flavonoids, along with coumarins and carbohydrates. *Centella asiatica* aqueous extract, on the other hand, included coumarins, steroids, tannin, flavonoids, and terpenoids. Thanks to its antioxidant properties, *Cynodon dactylon* may be useful in treating oxidative stress associated with ageing and a host of chronic disorders. Although this study emphasizes the impressive antioxidant properties of CD, it is crucial to do more research in order to determine which components are responsible for this impact. A more complete picture might be obtained by comparing it to other antioxidants. Finally, research into the potential uses of *Cynodon dactylon* as an antioxidant is warranted, since it shows promise as a natural source of these compounds.





## REFERENCES

- Jayasinghe, C.D., Gotoh, N., Aoki, T., & Wada, S. (2020). Phenolics composition and antioxidant activity of sweet basil (*Ocimum basilicum* L.). *Journal of Agricultural and Food Chemistry*, 51(15), 4442-4449.
- Brinkhaus, B., Lindner, M., Schuppan, D., Hahn, E.G., & Chemical, A.A. (2020). Chemical, pharmacological and clinical profile of the East Asian medical plant *Centella asiatica*. *Phytomedicine*, 7(5), 427-448.
- Ramakrishna, Y., Giridhar, P., & Sankar, K.U. (2021). Beneficial effects of *Centella asiatica* aqueous extract against arsenic-induced oxidative stress and essential metal status in rats. *Food and Chemical Toxicology*, 49(8), 1806-1812.
- Vijayakumar, M., Govindarajan, R., & Rao, G.M. (2020). Action of *Centella asiatica* (L.) Urb. on oxidative stress in rats with experimentally induced cirrhosis. *Journal of Ethnopharmacology*, 127(1), 190-193.
- Jurenka, J.S. (2017). Anti-inflammatory properties of *Cymbopogon citratus* and its potential use in hypertension. *Fitoterapia*, 89, 67-74.
- Prakash, A.O., & Shurpalekar, K.S. (2018). Flavonoids of *Cymbopogon flexuosus* Stapf. *Journal of Chromatography A*, 20, 309-310.
- Rao, P.V., Gan, S.H., & Candasamy, M. (2020). Antioxidant and radical scavenging activities of *Cynodon dactylon*. *Asian Pacific Journal of Tropical Medicine*, 3(12), 1001-1005.
- Kumar, S., & Kumar, D. (2022). Evaluation of antioxidant potential, phenolic and flavonoid content of *Cynodon dactylon*. *Journal of Chemical and Pharmaceutical Research*, 4(2), 1157-1160.
- Ghasemzadeh, A., Jaafar, H.Z.E., Rahmat, A., & Wahab, P.E.M. (2020). Halimatussaadiah, Influence of nitrogen on secondary metabolites production and antioxidant activities in different parts of *Centella asiatica* (L.) Urban. *Australian Journal of Crop Science*, 4(9), 676-681.
- Punturee, K., Wild, C.P., Vinitketkumnuen, U., & Kasinrerker, W. (2018). Immunomodulatory activities of *Centella asiatica* and *Rhinacanthus nasutus* extracts. *Asian Pacific Journal of Cancer Prevention*, 9(2), 331-335.
- Mensor LL, Menezes FS, Leitão GG, Reis AS, Santos TC, Coube CS. (2021) Screening of Brazilian plant extracts for antioxidant activity by the use of DPPH free radical method. *Phytother. Res.*;15:27–30.
- Cao G, Sofic E, Prior RL. (2022) Antioxidant and prooxidant behavior of flavonoids: Structure-activity relationships. *Free Rad. Biol. Med.* 22:749–760.
- Madsen HL, Nielsen BR, Bertelsen G, Skibsted LH. (2020) Screening of antioxidative activity of spices. A comparison between assays based on ESR spins trapping and electrochemical measurement of oxygen consumption. *Food Chem.*57:331–337.
- Moller JKS, Madsen HL, Altonen T, Skibsted LH. (2018) Dittany (*Origanum dictamnus*) as a source of water-extractable antioxidants. *Food Chem.* 64:215–219.
- Subathra M, Shila S, Devi MA, Panneerselvam C. (2017) Emerging role of *Centella asiatica* in improving age-related neurological antioxidant status. *Exp. Geronto.* 40:707–715.

Sample code	IC50 value (µg/ml)
Ascorbic Acid	4.948 µg/ml
CF ( <i>Cymbopogon flexuosus</i> )	81.11 µg/ml
CD ( <i>Cynodon dactylon</i> )	330.7 µg/ml
CA ( <i>Centella asiatica</i> )	91.78 µg/ml
CF( <i>Cymbopogon flexuosus</i> )(Oil)	47.21 %

Table 1: The DPPH Scavenging Assay – standard

Sample Conc.	Mean	SD	SEM	N
0	-3.5E-15	1.218652	0.609326	4
0.78	1.616915	2.995422	1.497711	4
1.56	13.0597	5.144304	2.572152	4





**Rajesh Kumar Sinha and Pawan Kumar Jain**

3.125	41.91542	3.309486	1.654743	4
6.25	67.78607	4.475308	2.237654	4
12.5	72.63682	2.470923	1.235461	4
25	80.0995	1.948149	0.974075	4
50	82.83582	3.211429	1.605714	4

**Table 2: The DPPH Scavenging Assay – CF(*Cymbopogon flexuosus (krishna)*)**

Sample Conc.	Mean	SD	SEM	N
0	3.86E-15	3.287653	1.643827	4
10.0	8.432148	2.630651	1.315325	4
50.0	46.90382	3.833668	1.916834	4
100.0	62.9776	1.245274	0.622637	4
250.0	72.06851	1.13847	0.569235	4
500.0	72.85903	1.521345	0.760672	4
1000.0	75.62582	0.997612	0.498806	4
2500.0	77.3386	5.618686	2.809343	4

**Table 3: The DPPH Scavenging Assay – CD (*Cynodon dactylon*)**

Sample Conc.	Mean	SD	SEM	N
0.0	1.48E-14	2.83849	1.419245	4
10.0	5.473965	2.5238	1.2619	4
50.0	11.08144	6.089054	3.044527	4
100.0	27.50334	9.685479	4.84274	4
250.0	46.46195	2.83849	1.419245	4
500.0	63.15087	3.97257	1.986285	4
1250.0	73.83178	2.068349	1.034174	4
2500.0	74.0988	6.363885	3.181943	4

**Table 4: The DPPH Scavenging Assay –CA(*Centella asiatica*)**

Sample Conc.	Mean	SD	SEM	N
0.0	0	1.832264	0.916132	4
10.0	6.056528	7.060499	3.53025	4
50.0	47.51009	2.50592	1.25296	4
100.0	63.79542	2.53943	1.269715	4
250.0	69.71736	0.807537	0.403769	4
500.0	70.12113	1.162986	0.581493	4
1250.0	71.46703	1.584883	0.792442	4
2500.0	72.27456	7.046803	3.523401	4

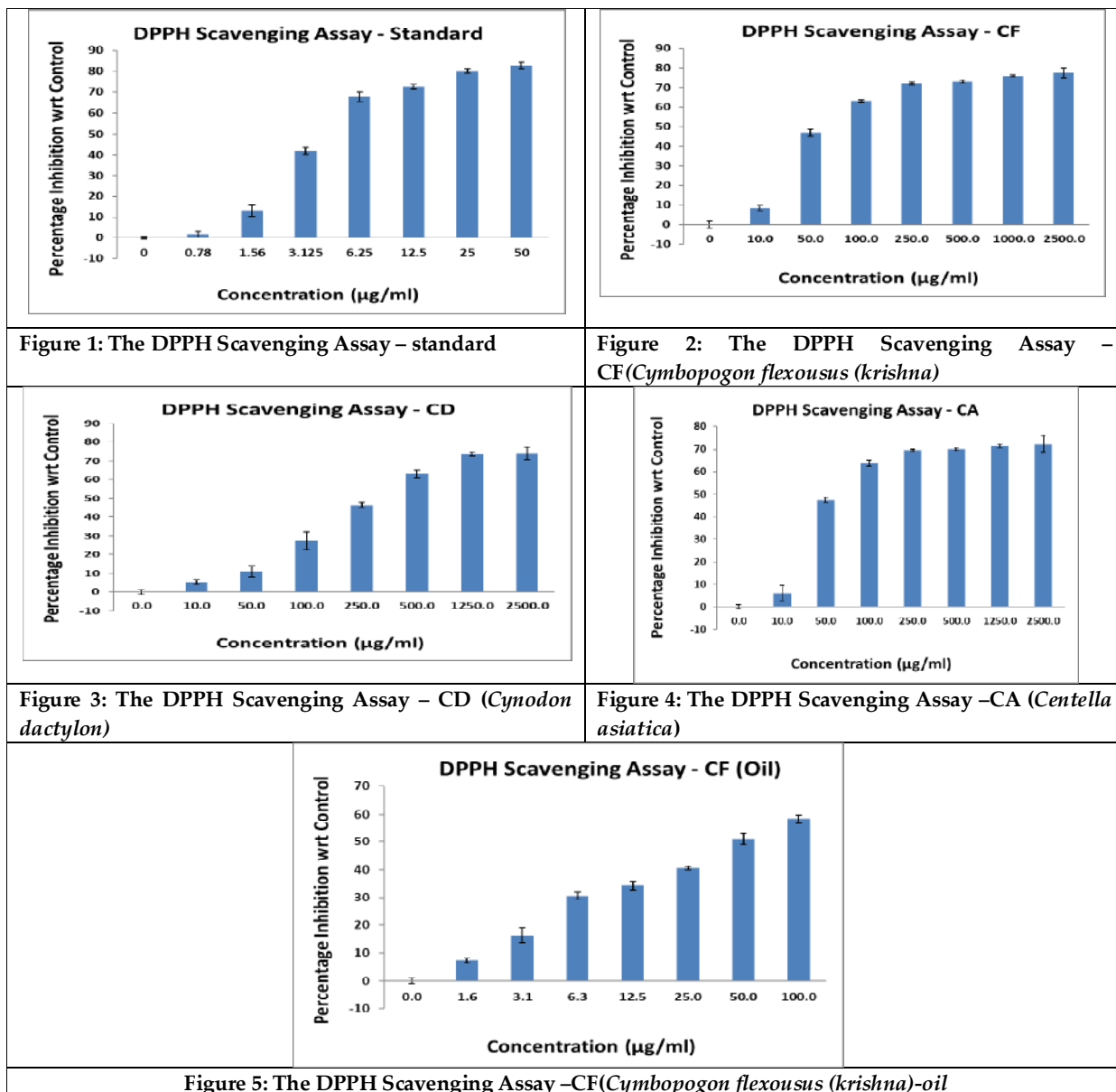
**Table 5: The DPPH Scavenging Assay –CF(*Cymbopogon flexuosus (krishna)*)-oil**

Sample Conc.	Mean	SD	SEM	N
0.0	0	2.120614	1.060307	4
1.6	7.289294	1.764457	0.882229	4
3.1	16.28702	5.369609	2.684804	4
6.3	30.63781	2.533155	1.266578	4
12.5	34.28246	2.84206	1.42103	4
25.0	40.5467	1.176305	0.588152	4
50.0	51.02506	4.241227	2.120614	4
100.0	58.31435	2.832917	1.416458	4





**Rajesh Kumar Sinha and Pawan Kumar Jain**





## Clinical Evaluation of Vallarai Nei (Internal) and Sembarithipoo Ennai (External) for the Management of Kalanjaga Padai (Psoriasis) in Children

C.Srinivasan<sup>1\*</sup>, A. Priya<sup>2</sup> and S. Abarna<sup>3</sup>

<sup>1</sup>Siddha Physician, Department of Kuzhanthai Maruthuvam, Sri Mruthyunjayam Siddha Clinic, Walajabad, Kanchipuram, Tamil Nadu, India.

<sup>2</sup>Siddha Physician, Department of Pothu Maruthuvam, Sri Mruthyunjayam Siddha Clinic, Walajabad, Kanchipuram, Tamil Nadu, India.

<sup>3</sup>Assistant Professor, Department of Sool Magalir Maruthuvam, Santhigiri Siddha Medical College, (Affiliated to Kerala University of Health Sciences) Kerala, India.

Received: 30 Jan 2024

Revised: 09 Feb 2024

Accepted: 27 Apr 2024

### \*Address for Correspondence

**C.Srinivasan**

Siddha Physician,

Department of Kuzhanthai Maruthuvam,

Sri Mruthyunjayam Siddha Clinic, Walajabad,

Kanchipuram, Tamil Nadu, India.

Email: csrinivas7639@gmail.com



This is an Open Access Journal / article distributed under the terms of the **Creative Commons Attribution License** (CC BY-NC-ND 3.0) which permits unrestricted use, distribution, and reproduction in any medium, provided the original work is properly cited. All rights reserved.

### ABSTRACT

Vallarainei is a medicated ghee formulation and SembarithipooEnnai is mentioned in Siddha literature for the management of KalanjagaPadai (Psoriasis) in Children. Its scientific validation, this drug was studied for its therapeutic effectiveness in KalanjagaPadaipatients. Its well-designed protocol was approved by the Institutional Ethics Committee and the study has been enrolled in the Clinical Trial Registry of India. The clinical study was conducted as a prospective, open label clinical trial in OPD of Ayothidoss pandithar Hospital of National Institute of Siddha, Chennai. Based on the inclusion criteria, 30 KalanjagaPadai patients were enrolled in this study. Informed consent was obtained from each patient before study initiation. Vallarainei (internal) Uchikkarandialavu (16 ml) twice a day, before food and SembarithipooEnnai (external) for a period of 45 days and advised to follow the prescribed dietary regimen. All the baseline data laboratory investigations were recorded in the prescribed Case Report Form of each patient. The clinical assessment was recorded. Student 't' test was employed to test the significance of treatment using before and after treatment data on PASI score and clinical symptoms. The level of significance probability 0.05 was used to test the treatment difference and the values are statistically extremely significant with, score ( $p < 0.0001$ ).

**Keywords:** KalanjagaPadai, Children, Clinical trial







Srinivasan et al.,

## INTRODUCTION

The Siddha system plays a wide-ranged role in the field of pediatrics. It ensures the children's health with its astonishing herbal formulations from their conception to prevent the illness. Skin diseases are classified into 18 varieties by Siddhar Yugi Munivar. One such skin disease is Kalanjaga padai. Symptoms of Kalanjaga padai can be correlated to those of the clinical entity Psoriasis in the modern system of medicine. The textbook "Siddha Maruthuvam Sirappu" described about Kalanjaga padai. In the Siddha system, skin disorders are brought under the clinical entity "Kuttam"[1]. Psoriasis is a common chronic skin disorder. It is characterized by the proliferation of keratinocytes, abnormal differentiation of keratinocytes, and inflammatory cell infiltration of the epidermis and dermis [2]. The most frequently observed variant of Psoriasis is the plaque type, followed by guttate Psoriasis. It affects children's quality of life, so increased attention should be paid to the early detection and treatment of affected children[3]. Psoriasis incidence in children increased significantly over time from 29.6 per 100,000 in 1970 through 1974 to 62.7 per 100,000 in 1995 through 1999. Chronic plaque psoriasis was the most common kind (73.7%), and the most commonly involved sites were the extremities (59.9%) and the scalp (46.8%) [4]. One such Siddha herbal formulation "Vallarai Nei" (Internal) and "Sembarithipoo Ennai" (External) mentioned in "Chikicha rathna deepam and The Pharmacopeia of Siddha Research Medicines" which is said to be an efficacious and simple formulation. The main ingredients of Vallarai nei formulation are Vallarai Saaru (*Centellaasiatica*), Poduthalai Saaru (*Phyla nodiflora*), Ponnangaani Saaru (*Alternanthera sessilis*), Elumichambazha Saaru (*Citrus limon*), Aavin paal (Cow milk), Aavin nei (Cow ghee), Jaathikai (*Myristica fragrans*), Jaathipathiri (*Myristica fragrans*), Maasikai (*Quercus infectoria*), Karkadagasingi (*Rhus succedanea*), Athimathuram (*Glycyrrhiza glabra*), Kaattathipoo (*Woodfordia fruticosa*), Vaal milagu (*Piper cubeba*), Elam (*Elettaria cardamomum*), Kraambu (*Syzygium aromaticum*) and ingredients of Sembarithipoo Ennai are Sembarithi poo (*Hibiscus rosasinensis*), Cocunut Oil (*Cocos nucifera*), Suraipattai (*Caparis grandis*), Vembadampattai (*Ventilago maderasapatana*). This study records its therapeutic efficacy clinically in Kalanjaga padai patients [5].

## MATERIAL AND METHODS

The clinical study was conducted using a standard protocol, after obtaining the approval of the Institutional Ethical Committee (IEC) NIS/IEC/2019/D-29-13.09. 2019. The trial was registered in clinical trial registry of India with Reg.no CTRI/2020/06/026154 (Registered on date 26/06/2020). It is an open clinical trial conducted at Ayothidoss Pandithar Hospital OPD.NO.4 Dept of Kuzhandhai Maruthuvam, National Institute of Siddha, Tambaram Sanatorium, Chennai.

## SUBJECT SELECTION

Patients reporting at OPD of Ayothidoss Pandithar Hospital with symptoms of inclusion criteria will be subjected to a screening test and documented using screening Performa. After screening of patients diagnosed as Kalanjaga padai, 30 cases were selected in this trial. Before enrolment into the trial the informed consent was obtained in writing from their parents in the consent form

### Inclusion criteria

- Age: 5 – 12 years
- Sex: Both male and female children.
- Erythema
- Thickness
- Scaling
- With or Without itching



**Srinivasan et al.,**

- Auspitz sign +ve
- Candle crease sign +ve
- Cracks followed by itching
- Dryness of the skin
- Patients with two are more symptoms that are included into the study.
- Willing to cooperate for taking photographs whenever required with his\her consent.
- Patients who were willing to attend OP Dept. as on required.
- Patient's informant / Parent willing to sign the informed consent.

**Exclusion criteria**

- Psoriatic arthritis
- Eczema
- Psoriasis with evidence of any other skin diseases
- Fungal infection
- Systemic (cardiac) involvement
- Lesions with secondary infection
- Epilepsy<sup>6,7</sup>

**Withdrawal criteria**

- Exacerbation of symptoms and signs
- If any adverse reactions and unwanted symptoms occurred during the drug trial.
- Intolerance to the drug.
- Patient turned unwilling to continue in the course of clinical trial.
- Occurrence of any serious illness.

**CONDUCT OF THE STUDY**

All the patients were given unique registration card having patient's Registration number of the study, Address, Phone number and doctor's contact number etc. All the baseline findings, vitals, clinical signs and symptoms, laboratory and in siddha aspect En vagai thervugal were done on the 0<sup>th</sup> day and 46<sup>th</sup> day of the trial. Selected patients were given oil bath, purgation, with OPD Medicines and following rest as pre-treatment procedure for 3 days. The trial drug Vallarai Nei (Internal) Uchikkarandi alavu (16 ml) twice a day, before food and Sembarithipoo Ennai (External) will be given for 45 days and the Patients are advised to visit the OP once in 7 days. At each visit, the patient's vitals and clinical assessments were recorded in the case report form by the doctor.

**OBSERVATION****STATISTICAL ANALYSIS**

All collected data have entered MS Excel software using different columns as variables and rows as patients. SPSS software has used to perform statistical analysis. Basic descriptive statistics include frequency distributions, and cross-tabulations have performed. The quantity variables have expressed as Mean  $\pm$  Standard Deviation and qualitative data as a percentage. A probability value of  $<0.05$  has considered indicating statistical significance. t-test has performed for determining the significance between before and after treatment. In this study, statistical analysis has done for the PASI score.

**DISCUSSION**

In Siddha literature Kalanjagapadai, which correlated with Psoriasis. Psoriasis is an abnormal inflammatory skin condition which is often associated with systemic manifestation. It affects skin, nail, joints of children. Plaque type of psoriasis was the most common type in children. It begins in childhood in almost one-third of the cases, and the issued incidence rates in children have more than doubled since 1970. Childhood psoriasis is a well-recognized





Srinivasan et al.,

entity. Incidence in the age group of 0-9 years is ~0.55% and in the age group of 10-19 years is 1.37%. Age of onset ranged from 4 days to 14 years, male and female incidence was equal. Even though, Kalanjaga padai is non-contagious disease, it affects the quality of life in children. Longstanding itching and scaling may affect the academic performance of many children. The clinical Trial for clinical evaluation of Siddha herbal formulation Vallarai Nei (Internal) & Sembarithipoo Ennai in the Treatment of Kalanjaga padai. According to this study male children were affected more than the Female children. This study showed that the highest incidence of Kalanjaga padai was between the age group 9-10 years cases (54%) were to found. Among 30 children, 80% had the illness about 1 month to 2 years, 13% had the illness about 2 years to 4 years, and 7% had the illness about 4 years to 6 years.

Family history of Among 30 children, 27% had a family history, 73% did not have any family history. Immunization History of Among 30 children, 93% had proper immunization history, 7% did not have proper immunization history. Food Habits of Among 30 children enrolled in this study, about 3% were vegetarians, and 97% were non-vegetarians. But the disease does not influence by diet. Bowel Habits of among 30 children enrolled in this study, about 93% had regular bowel habits, and 7% had irregular bowel habits. Envagaithervu of Among 30 children, about 100% were affected with niram and sparisam in Envagaithervu due to scaling and erythematous lesion present in the skin. Neikkuri among the 30 children, 30% have showed vaathaneer neikkuri, 57 % have showed Pithaneer neikkuri, and 13 % have showed kabaneer neikkuri. Out of 30 children, about 37% had Vaathapitha naadi, 40% had Pithavaath anaadi, and 23% had Vathakaba naadi. Site of lesions in out of 30 cases, 23% of the cases had lesions in the head and face, 27% of the cases has lesions in the lower limb and sole, 50% of the cases has lesions in 2 or more than 2 affected sites in the body (Head, face, Upper limb Lower limb). Clinical improvement of Itching, Scaling and Erythematous lesions were reduced Well after treatment. This is because the Ingredients of the trial drugs contains Anti-inflammatory, Anti- Psoriatic activity, immunomodulator and Anti-pruritic Which were responsible for the reduction of lesions, Scaling and itching. The outcome has clinically observed by PASI score, that was among 30 Children, 80% (24) have shown Good and 13% (4) shown moderate improvement and 7% (2) have Shown mild improvement. The results showed that Vallarai Nei (Internal) and Sembarithipoo Ennai (External) were effective in treating Kalanjaga Padai in Children clinically.

## CONCLUSION

From this study, Vallarai Nei (Internal) and Sembarithipoo Ennai (External) is safe, efficacious and cost-effective, potent herbal drug in the treatment of KalanjagaPadai (Psoriasis).The ingredients of Vallarai Nei and Sembarithipoo Ennai has Anti- psoriatic, Anti-inflammatory, Anti pruritic activity and Immuno modulator activity. The PASI score concluded, that was among 30 Children, 80% (24) were shown Good and 13% (4) shown moderate improvement and 7% (2) were shown mild improvement. Statistical analysis was done for PASI Score, before and after treatment has been Significantly reduced. ( $p= 0.0001$ ). Therefore, the trial drug Vallarai Nei and Sembarithipoo Ennai is clinically effective. There was no adverse reaction reported during the trial period. The study maybe further carried out with the same drug "Vallarai Nei" and "Sembarithipoo Ennai" in a larger clinical population because of the favourable clinical outcome.

## REFERENCE

1. Dr. R. Thiyagarajan L. I. M, Text book of Sirappu maruthuvam-Sirappu, 1st edition, Commissionerate of Indian medicine and homeopathy, chennai, Reprint, 2013.
2. Frank O Nestie, M.D., Daniel H. Kaplan., M.D, P h D., and Jonathan Barker., M.D, Review article ; Mechanism of disease Psoriasis, The new england journal of medicine, 2009;361:496-509.
3. Nelson paediatric book (Pg. no 2702) Nelson textbook of paediatric vol III.
4. Gelfand JM, Weinstein R, Porter SB, Neimann AL, Berlin JA, Margolis DJ. Prevalence and treatment of psoriasis in the United Kingdom: a population-based study. Arch Dermatol. 2005;141(12):1537–1541.





**Srinivasan et al.,**

5. Kannusamipillai C Sigichaa Rathna Deepam Ennum Vaithiyanoor, part1,Rathnanayakar and sons, Edition: (2007), page no: 207
6. Bajaj AK,Dr.Rajeev Sharma, Dr.Sandipan Dhar, Dermatology, Leprosy,& Sexually Transmitted Infections ,2nd edition ( 2010),JPBMP
7. Behl PN,Practice of dermatology.7th Edition.CBS publishers and distributors, Delhi,India(1990).
8. Shanmugavelu M, Noinadal noyimudhal naadal part-I, 3rd Edition, Dept. of Indian medicine and homeopathy, Chennai (2003).
9. Haldar B, Diagnosis and traetment of skin disorders, 1st Edition,Calcutta skininstitute, calcutta.
10. Williams D James, MD, Timothy G Berger,MD., Drik M Elston MD, Andrews’ diseases of the skin, Clinical dematology, 10th edition,Elsevier

**Table 1: GENDER DISTRIBUTION**

GENDER	NO OF CASES	PERCENTAGE
Male Child	18	60%
Female Child	12	40%

Gender distribution among 30 children, 60% of cases were male children and 40% of cases were female children

**Table:2 AGE DISTRIBUTION**

AGE	NO OF CASES	PERCENTAGE
5-6 years	1	3%
7-8 years	7	23%
9-10 years	16	54%
11-12 years	6	20%

Age distribution among 30 children, 3% of cases were between 5 and 6 years, 23% of cases were between 7 and 8 years, 54% of cases were between 9 and 10 years, and 20% of cases were between 11 and 12 years.

**Table:3 DURATION OF ILLNESS**

DURATION	NO OF CASES	PERCENTAGE
1 Month-2 Years	24	80%
3-4 Years	4	13%
5-6 Years	2	7%

Among 30 children, 80% had the illness about 1 month to 2 years, 13% had the illness about 3 years to 4 years, and 7% had the illness about 5 years to 6 years.

**Table:4 FAMILY HISTORY DISTRIBUTION**

FAMILY HISTORY	NO OF CASES	PERCENTAGE
Yes	8	27%
No	22	73%

Among 30 children, 27% had a family history,73% did not have any family history.

**Table: 5 IMMUNISATION HISTORY DISTRIBUTION**

IMMUNISATION	NO OF CASES	PERCENTAGE
Yes	28	93%





Srinivasan et al.,

No	2	7%
----	---	----

Among 30 children, 93% of the cases had proper immunization history, 7% had have improper immunization history.

**Table:6 FOOD HABITS DISTRIBUTION**

FOOD HABITS	NO OF CASES	PERCENTAGE
Vegetarian	1	3%
Nonvegetarian	29	97%

Among 30 children enrolled in this study, about 3% of cases were vegetarians, and 97% of cases were non-vegetarians. It does not influence psoriasis.

**Table:7 BOWEL HABITS DISTRIBUTION**

BOWEL HABITS	NO OF CASES	PERCENTAGE
Regular	28	93%
Irregular	2	7%

Among 30 children enrolled in this study, about 93% had regular bowel habits, and 7% had irregular bowel habits.

**Table:8 UDAL THADHUKKAL DISTRIBUTION**

UDAL THADHUKKAL	NORMAL	AFFECTED
Saaram	0%	100%
Senneer	0%	100%
Oon	0%	100%
Kozhuppu	100%	0%
Enbu	100%	0%
Moolai	100%	0%
Sukkilam/Suronitham	100%	0%

According to the study, Saaram was affected in 100% of cases due to fatigue, Senneer was affected in 100% due to the presence of itching, Oon was affected in 100% due to the presence of scaling and erythematous lesion.

**Table: 9 NEIKKURI DISTRIBUTION**

NEIKKURI	NO OF CASES	PERCENTAGE
Vatham	9	30%
Pitham	17	57%
Kabam	4	13%

Neikuri among the 30 children 30% have shown vaathaneer neikuri, 57 % have showed Pithaneer neikuri, and 13 % have shown kabaneer neikuri.

**Table:10 ENVAGAI THERVU DISTRIBUTION**

ENVAGAI THERVU	NORMAL	AFFECTED
Naa	100%	0%
Niram	0%	100%
Mozhi	100%	0%
Vizhi	100%	0%
Sparisam	0%	100%
Malam	97%	3%
Moothiram	100%	0%

Among 30 children, 100% of the cases were affected with niram, 100% of the cases were affected with sparisam in Envagai thervu due to scaling and erythematous lesion present in the skin.





Srinivasan et al.,

Table: 10 NEIKKURI DISTRIBUTION

NEIKKURI	NO OF CASES	PERCENTAGE
Vatham	9	30%
Pitham	17	57%
Kabam	4	13%

Neikkuri among the 30 children 30% have shown vaathaneer neikkuri, 57 % have showed Pithaneer neikkuri, and 13 % have shown kabaneer neikkuri.

Table: 11 NAADI DISTRIBUTION

NAADI	NO OF CASES	PERCENTAGE
Vatha Kabam	7	23%
Pitha Vatham	12	40%
Vatha Pitham	11	37%

Out of 30 children, about 37% had Vaathapitha naadi, 40% had Pithavaatha naadi, and 23% had Vathakaba naadi<sup>8</sup>.

Table: 12 SITE OF LESION DISTRIBUTION

SITE	NO OF CASES	PERCENTAGE
Head and Face	7	23%
2 Or More Than 2 Affected Site (Head,Face,Upper limbor Lower limb)	15	50%
Lower Limb and Sole	8	27%

Out of 30 cases, 23% of the cases had lesions in the head and face, 27% of the cases had lesions in the lower limb and sole, 50% of the cases had lesions in 2 or more than 2 affected sites in the body.

Table:13 CASE REPORT OF CHILDREN BASED ON PASI SCORE<sup>9,10</sup>

S.NO	OP.NO	AGE	SEX	B T	AT	PASI	RESULT
1	137125	10	M	15.4	3.2	PASI 75	GOOD
2	131447	10	F	3.0	0	PASI 75	GOOD
3	137544	5	F	16.0	0.8	PASI 75	GOOD
4	139074	7	M	0.8	0	PASI 75	GOOD
5	139224	7	M	18.4	6.2	PASI 50	MODERATE
6	K91221	10	F	35.7	3.8	PASI 75	GOOD
7	K32899	9	M	13.8	2.2	PASI 75	GOOD
8	6859	9	M	5.6	0.4	PASI 75	GOOD
9	5841	10	F	1.2	0	PASI 75	GOOD
10	55839	7	M	1.0	0	PASI 75	GOOD
11	8973	11	M	5.6	2.4	PASI 25	MILD
12	125937	12	M	5.6	1.2	PASI 75	GOOD
13	144125	11	M	1.0	0.2	PASI 75	GOOD
14	139461	10	M	11.2	1.8	PASI 75	GOOD
15	104214	9	M	8.4	1.2	PASI 75	GOOD
16	102969	7	M	1.0	0.4	PASI 50	MODERATE
17	93104	8	M	0.4	0	PASI 75	GOOD
18	148184	9	M	4.0	0.6	PASI 75	GOOD
19	141929	12	F	5.6	1.6	PASI 75	GOOD
20	117541	12	M	6.4	2.6	PASI 25	MILD
21	149570	10	M	0.4	0	PASI 75	GOOD
22	146370	10	M	11.7	1.8	PASI 75	GOOD





**Srinivasan et al.,**

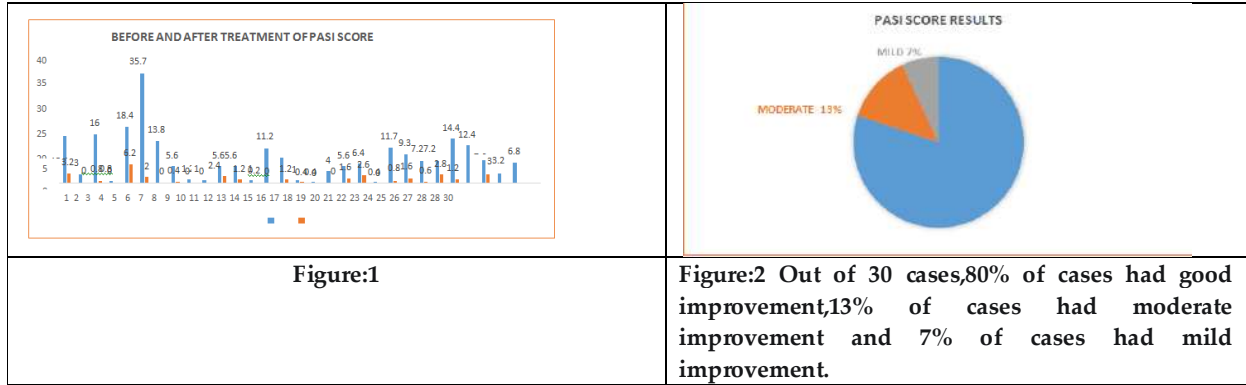
23	8239	10	F	9.3	1.6	PASI 75	GOOD
24	144076	12	F	7.2	0.6	PASI 75	GOOD
25	122630	10	F	7.2	2.8	PASI 50	MODERATE
26	149030	10	F	14.4	1.2	PASI 75	GOOD
27	153683	7	F	12.4	1.4	PASI 75	GOOD
28	144720	9	M	7.6	3	PASI 50	MODERATE
29	63265	9	M	3.2	0.2	PASI 75	GOOD
30	145006	7	F	6.8	0.8	PASI 75	GOOD

**Table: 14 PASI SCORE RESULTS**

PASI SCORE	NO OF CASES	PERCENTAGE
GOOD	24	80 %
MODERATE	4	13 %
MILD	2	7 %

**Table.15 Distribution of Mean and Standard Deviation of before and after treatment**

PASI Score	Mean ± Standard Deviation	t value	P value
Before Treatment	8.006 ± 7.352	5.6154	0.0001
After Treatment	1.4± 1.423		





Srinivasan et al.,



Figure:3 Psoriasis Images Before Treatment



Figure:4 After Treatment



Figure:5 Before Treatment



Figure:6 After Treatment



Figure:7 Before Treatment



Figure:8 After Treatment







Figure:9 Before Treatment



Figure:10 After Treatment



Figure:11 Before Treatment



Figure:12 After Treatment





## Modern Techniques in Linear Programming

A. Kalaiyarasi<sup>1\*</sup> and H. Velwet Getzimah<sup>2</sup>

<sup>1</sup>Assistant Professor, Department of Mathematics, Kamaraj College, Thoothukudi, (Affiliated to Manonmaiam Sundaranar University, Abishekapatti, Tirunelveli) Tamil Nadu, India.

<sup>2</sup>Assistant Professor, Department of Mathematics, Pope's College (Autonomous), (Affiliated to Manonmaiam Sundaranar University, Abishekapatti, Tirunelveli) Tamil Nadu, India.

Received: 30 Jan 2024

Revised: 09 Feb 2024

Accepted: 26 Apr 2024

### \*Address for Correspondence

#### A. Kalaiyarasi

Assistant Professor,  
Department of Mathematics,  
Kamaraj College, Thoothukudi,  
(Affiliated to Manonmaiam Sundaranar University, Abishekapatti, Tirunelveli)  
Tamil Nadu, India.  
Email: ranikalai1976@gmail.com



This is an Open Access Journal / article distributed under the terms of the **Creative Commons Attribution License** (CC BY-NC-ND 3.0) which permits unrestricted use, distribution, and reproduction in any medium, provided the original work is properly cited. All rights reserved.

### ABSTRACT

A Linear Programming is a mathematical modeling in which a linear function is maximized or minimized subject to certain constraints to determine the optimal values for all the parameters of the function. This technique is widely used in business and industry for decision making and various types of scheduling in order to optimize an estimation within the limitations of available resources. Graphical and Simplex Methods are the general procedures adopted to solve linear programming problems. With a boon to modern inventions, most of the computer programming languages recently support us in solving linear programming problems in a simple way thereby reducing complexity. This paper illustrates solving practical life problems in linear programming with the usage of the solver in Microsoft Excel.

**Keywords:** Solver, resource constraints, objective function.

### INTRODUCTION

A Linear Programming model is a mathematical programming in which the objective function is a linear expression of the decision variables. The constraints are given by a system of linear equations which are inequalities. This technique is widely used in taking quantitative decisions in business, industrial engineering, and also in social and physical sciences. The basic assumption in this method is that the various relationships between demand and availability are linear. A Linear Programming problem has basically three components namely, the objective function which is either maximization or minimization, the resource constraints given in inequalities and





### Kalaiyarasi and Velwet Getzimah

the non-negativity of the variables. If a problem consists of only two variables, the graphical method of solving the problem is easy. If a problem has three or more solution variables, simplex method is the most appropriate method of solving it. Nowadays, there are various computer applications available for solving Linear Programming problems. With the invention of new technologies in computer, recently Microsoft Excel is helpful in finding solutions to Linear Programming problems with its "SOLVER" application. This paper explores how a simple Linear Programming problem can be solved in the Excel, using the Solver.

#### SOLVER IN EXCEL

A solver is a mathematical tool in Excel used to perform calculations by working under some constraints in getting solution to the problem. It works on the objective cell by changing the variable cells any by using the sum constraints. The solver can also find solutions to complex business problems, create the most appropriate project schedule, minimize an organization's expenses on transportation of its employees, maximize the profits generated by a marketing plan and so on. For every problem, the goal which is termed as objective, the variables and the constraints are identified. The solver returns an optimal solution which sets accurate values of the variables, satisfies all constraints, and meets the goal. It works with a group of cells called decision variable cells that are used in computing the formulas in the objective and constraint cells. Solver adjusts the values in the decision variable cells to satisfy the limits on constraint cells and produce the result we need for the objective cell. The solver can also solve arithmetic equations, linear and nonlinear problems. Once the solver is activated in Microsoft excel we can find optimal solutions for all decision problems.

#### THE SAMPLE PROBLEM OF TWO VARIABLES

Linear Programming applications include many practical life problems such as production scheduling, inventory policies, investment portfolio, allocation of advertising budget, construction of warehouses, etc. for which solutions can be easily arrived by the usage of modern techniques thereby saving time. In this article, we would focus on the different components of the output generated by Microsoft excel while solving a basic Linear Programming model. For example, we consider the problem of producing two products  $P_1$  and  $P_2$  with raw materials  $M_1$ ,  $M_2$  and  $M_3$ . The materials required to produce one unit of the product  $P_1$ ,  $P_2$  are  $x_1$  and  $x_2$  respectively. The following is the tabulation:

Raw materials	$P_1$	$P_2$
$M_1$	2	1
$M_2$	2	5
$M_3$	2	3

Available raw materials of  $M_1$ ,  $M_2$  and  $M_3$  are 50, 100 and 90 units, respectively. Contribution per unit of  $P_1$  is \$ 80 and  $P_2$  is \$ 90. To determine the number of each product that optimizes the maximum contribution we can apply Microsoft Excel as below

#### SOLUTION

The model for the above Linear Programming problem is:

Objective Function: Max  $Z = 4x_1 + 10x_2$

Subject to the constraints  $2x_1 + x_2 \leq 50$  (resource limitation of  $M_1$ )

$2x_1 + 5x_2 \leq 100$  (resource limitation of  $M_2$ )

$2x_1 + 3x_2 \leq 90$  (resource limitation of  $M_3$ )

where  $x_1, x_2 \geq 0$

To provide an easy approach of solving the above problem with Excel Solver, we can consider the following steps in order.

**Step 1:** Set the information in a table in Excel Worksheet including the contributions and constraints as in the Model.





**Kalaiyarasi and Velwet Getzimah**

	C	D	E	F	G	H	I	J
10				Possible				
11		x1	x2	Max				
12	Solution			0				
13	Contribution	4	10					
14								
15	Constraints					Limits		
16	R' Material M1	2	1	0	<=	50		
17	R' Material M2	2	5	0	<=	100		
18	R' Material M3	2	3	0	<=	90		
19								
20								
21								
22								
23								

In the above table,

Cell  $F_{12}$  is set out with the formula:  $=D_{12} * D_{13} + E_{12} * E_{13}$

Cell  $F_{16}$  is set out with the formula:  $=D_{12} * D_{16} + E_{12} * E_{16}$

Cell  $F_{17}$  is set out with the formula:  $=D_{12} * D_{17} + E_{12} * E_{17}$

Cell  $F_{18}$  is set out with the formula:  $=D_{12} * D_{18} + E_{12} * E_{18}$

**Step 2:** Click the "Solver" in Analysis and do the following.

In the "Solver Parameter",

**Step 3:** Set the Target Cell (in this case,  $F_{12}$  in YELLOW in the table above)

**Step 4:** Set the Optimization Problem (Max or Min or for an Expected Value)

**Step 5:** Set the Changing Cells (in this case,  $D_{12}$  and  $E_{12}$  of Solution in GREEN)

**Step 6:** Click "Add" in the solver and do the following to add constraints

In the "Add Constraints",

**Step 7:** Set the "Cell Reference" of Possible Max use of  $M_1$  (in this case  $F_{16}$  in BLUE)

Set the constraint symbol (in this case  $<=$ )

Set the constraint cell of Limit of  $M_1$  (in this case  $H_{16}$  in BLUE)

Click "Add" to add the constraint of  $M_2$

**Step 8:** Set the "Cell Reference" of Possible Max use of  $M_2$  (in this case  $F_{17}$  in ORANGE)

Set the constraint symbol (in this case  $<=$ )

Set the constraint cell of Limit of  $M_2$  (in this case  $H_{17}$  in ORANGE)

**Step 9:** Set the "Cell Reference" of Possible Max use of  $M_3$  (in this case  $F_{18}$  in BROWN)

Set the constraint symbol (in this case  $<=$ )

Set the constraint cell of Limit of  $M_3$  (in this case  $H_{18}$  in BROWN)

Click "Add" to add the constraint of  $M_3$

**Step 10:** Close Add Constraint

**Step 11:** Click "Options" and tick "Assume Linear Model" and "Assume Non-Negative"

**Step 12:** Click "OK" in the "Solver Options"

**Step 13:** Click "Solve" in the "Solver Parameter" and

Click "OK" in the "Solver Results" to get the problem solved in the Cells

The result will appear as in the following table:





**Kalaiyarasi and Velwet Getzimah**

G25		✕ ✓ <i>fx</i>					
	C	D	E	F	G	H	I
10				Possible			
11		x1	x2	Max			
12	Solution	0	20	200			
13	Contribution	4	10				
14							
15	Constraints					Limits	
16	R' Material M1	2	1	20	<=	50	
17	R' Material M2	2	5	100	<=	100	
18	R' Material M3	2	3	60	<=	90	
19							
20							
21							

**CONCLUSION**

The application of modern techniques in linear programming problems help us to solve even complex problems with simplified assumptions. In this paper, the idea of solving a linear programming problem using solver in Microsoft excel is focused and this technique can also help one to solve smooth non linear problems. Since linear programming techniques are widely applied in industries, as a topic of further research excel solver algorithms can be learnt which would definitely help us to solve complex problems in data science which is a recent field growing significantly with wide range of applications in today's digital world.

**REFERENCES**

1. Taha, H. A. (2011). Operations research: An introduction. 9th Ed. Pearson: New Jersey.
2. Winston, W. L. (2004). Operations research: Applications and algorithms (4th ed.) Brooks: Canada.
3. Daniel Fylstra, Leon Lasdon, John Watson, and Allan Waren (1998), "Design and Use of the Microsoft Excel Solver", COMPUTERS / Computer Science Software Interfaces 28(5), Pp. 29–55.
4. Caine D.J., Parker B.J., (1996), "Linear Programming comes of age: a decision support tool for every manager", Management Decision, 34(4), Pp. 46-53.
5. Fourer, R.; Gay, D. M.; and Kernighan, B. W. (1993), " AMPL: A Modeling Language for Mathematical Programming", Duxbury Press, Pacific Grove, California.





## *In silico* Molecular Docking of Columbin Compounds from *Tinospora cordifolia* against *Aedes aegypti* Receptor Molecule: Bio Control Strategy

A.Antony Annammal<sup>1\*</sup>, P.Preethi<sup>2</sup> and B.Geetha<sup>3</sup>

<sup>1</sup>Research Scholar (Reg.No:19212232192044), PG and Research, Department of Zoology, V.O.Chidambaram College, Tuticorin, (Affiliated to Manonmanium Sundaranar University, Abishekapatti, Tirunelveli,) Tamil Nadu, India.

<sup>2</sup>Research Scholar ((Reg.No:21212232102012), PG and Research Department of Zoology, V.O.Chidambaram College, Tuticorin, (Affiliated to Manonmanium Sundaranar University, Abishekapatti, Tirunelveli,) Tamil Nadu, India.

<sup>3</sup>Associate Professor, PG and Research Department of Zoology, V.O.Chidambaram College, Tuticorin, (Affiliated to Manonmanium Sundaranar University, Abishekapatti, Tirunelveli,) Tamil Nadu, India.

Received: 30 Jan 2024

Revised: 09 Feb 2024

Accepted: 27 Apr 2024

### \*Address for Correspondence

#### A.Antony Annammal

Research Scholar (Reg.No:19212232192044),

PG and Research,

Department of Zoology,

V.O.Chidambaram College, Tuticorin,

(Affiliated to Manonmanium Sundaranar University, Abishekapatti, Tirunelveli,)

Tamil Nadu, India.

Email: angelpappu168@gmail.com



This is an Open Access Journal / article distributed under the terms of the **Creative Commons Attribution License** (CC BY-NC-ND 3.0) which permits unrestricted use, distribution, and reproduction in any medium, provided the original work is properly cited. All rights reserved.

### ABSTRACT

In this study, we highlighted several important findings from protein-ligand docking in the context of insecticide resistance conducted by glutathione S-transferases (GSTs), a detoxifying superfamily enzyme. The study reported Gc-ms analysis of plant compounds and insilico evidences of GST binding to chemical insecticides in dengue vectors (*Aedes aegypti* mosquitoes). Our findings indicate that epsilon class members GSTE2 can metabolize insecticides. The findings highlight the significance of docking research in understanding enzyme action and pave the way for the future application of new mosquito control management tactics by biotechnological advancements aimed at specific GST targets. Induced mutations on GST catalytic binding sites could improve resistance and reduce damage, whereas rational drugs can be created to block GSTE members to reduce resistance in mosquito control. In all circumstances, the methods focusing on GSTs might be created to lessen the environmental impact of pesticide use.

**Keywords:** molecular docking, GST enzymes, biocontrol, Gc-ms analysis, *Aedes aegypti*



**Antony Annammal et al.,**

## INTRODUCTION

Modern drug design processes frequently include molecular docking techniques to comprehend protein ligand interactions. Understanding how proteins interact with one another and carry out biological tasks can be greatly aided by understanding the three-dimensional structure of the protein-ligand complex. Thus, one of the key problems in biological sciences is understanding the precise atomic structure of protein-ligand and its complexes. However, conformational changes take place upon ligand interaction in the protein databank where the majority of docking research are conducted. Small side chain rotations may be required for this, which would improve interactions with the ligand. Modern structure-based drug discovery initiatives now frequently include insilico docking experiments. Therefore, understanding the interactions of the individual medications with the proteins and ligands may offer important insight into the binding relationships and relativeness of the drug. Alkaloids, alcohols, nitro compounds, long chain hydrocarbons, steroids, esters, amino acids, and organic acids have all been identified using the Gc-ms approach in detection of functional groups in a tiny percentage of pure plant extract [1,2] In many parts of India, *Tinospora cordifolia*, a herbaceous climber belonging to the Menispermaceae family, is also known as Giloy, Amrita, Guduchi, Gulancha, Ambervel, Gulvel, and other names [3]. This herb's stem has been seen to change in thickness and color with age and season, and it typically has a harsh flavor. Due to its strong therapeutic efficacy and capacity for rejuvenation, it is also known as "Heavenly Elixir." Reviews of its phytochemistry, ethnopharmacology, and therapeutic qualities have been published in the literature with a focus on its potential for immunomodulation[4]. According to these investigations, this locally produced medication represents a cutting-edge possibility for bioprospecting and drug development for the treatment of conditions including cancer, liver problems, ulcers, diabetes, heart conditions, postmenopausal syndrome, etc. With the addition of glutathione (GSH), glutathione S-transferases (GSTs) quench reactive chemicals and shield the cell from oxidative damage. The highly promiscuous enzyme superfamily known as glutathione S-transferases (GSTs) is crucial to the detoxification of a wide variety of xenobiotic chemicals in the cytoplasm of many different species. The tripeptide glutathione is conjugated to a hydrophobic and cytotoxic substance in the primary reaction catalyzed by the GSTs, creating a new conjugate that is more soluble. According to the study there are six GST classes found in insects[5,6]. One particular enzyme, glutathione s transferase belongs to this protein superfamily and has been linked to chemical pesticide resistance in the mosquitoes *Aedes aegypti*, which are the primary carriers of dengue fever, respectively[7]. In this study we are focusing on the identification of compound by inhibiting the enzyme glutathione s transferase epsilon 2 in *Aedes aegypti*.

## MATERIALS AND METHODS

### Preparation of plant material

The stem of *Tinospora cordifolia* were collected from Nagercoil, Kanniyakumari district. The collected stem parts were cut into pieces dried in the shady places and then blended. 50 grams of powdered stem parts were soaked in 300 ml ethanol extract and kept in a rotary shaker for an hours. The experiment was repeated for two days and then plant extract were extracted using muslin cloth and air dried for a days. The crude extract were kept at 4°C for further analysis.

### GC-MS analysis

Crude sample was run through a 0.22 mM syringe-driven filter prior to GC-MS. Agilent's gas chromatography with a directly connected Mass Selective Detector (MSD) (Agilent 7820 A model 5977E; Agilent) was used for the GC mass spectroscopy examination. At 70 eV, the mass spectrometer was run in the electron impact mode. Chromatographic separation was evaluated using helium as the carrier gas at 1 ml/min in a constant flow rate mode and a sample injection volume of 1 microliter on the fused-silica capillary column HP- 5MS (30 m × 0.25 mm × 0.25 mm). The MSD transfer line was maintained at a temperature of 250 °C. Retention times (RT) and mass spectra were compared to data to determine the bioactive components.



Antony Annammal *et al.*,

### Preparation and ligand and receptor

The PUBCHEM compounds database was used to obtain the structures of the chemicals found in the ethanol stem extract of *Tinospora cordifolia*. The same method was employed to forecast the ligand's properties, including pH, refractivity, logP value, hydrogen donors, acceptors, and molecular weight. The Lipinski Rule of Five was used to evaluate these compounds for therapeutic potential [8]. The Research Collaboratory for Structural Bioinformatics Protein Data Bank (PDB ID:5FT3) was used to extract the crystal structure of Glutathione S-transferase epsilon 2 enzyme receptor [9]

### Docking analysis

The crystal structure of GSTE2 (code 5FT3) of *A. aegypti* was retrieved from the PDB for molecular docking and molecular modelling was performed using the SPDB viewer ([www.expasy.org/spdbv/](http://www.expasy.org/spdbv/)). GSTE2 visualisation and Castp online server energy minimization was utilised to locate GSTE2 binding pocket active location based upon toxicology, larvicidal action, medical applications, IC50 value, and chemical structure. *T. cordifolia* bioactive chemicals, structure were gathered from the Pubchem database and produced using the Simplified Expanding Molecular Input Line Entry Specification notation Babel Application. Energy reduction and geometry optimization were after building the structures, accept out using the Chimera software. The Molecular Docking Server performed the molecular docking computations. The active site was defined using autogrid. The specified grid box provides enough space for the ligand translation, 50° for rotation and the maximum number of energy evaluations was set to 2,000,000. Thirty runs were performed. To create prospective ligand-receptor complexes, the most active compound was docked to its probable targets. The 3D structure of GSTE2 from *Aedes aegypti* was downloaded from Protein Data Bank (<http://www.rcsb.org/>) and inspected using the Discovery Studio program in order to conduct protein modeling experiments. Finally, docking investigations were carried out using Auto Dock Vina with a protein 5FT3 and ligands of *Tinospora cordifolia*.

## RESULTS AND DISCUSSION

In the ethanol stem extract of *Tinospora cordifolia*, the GC-MS data revealed the presence of bioactive components Fig. 1 and Table 1. The most promising drug were identified by docking with Discovery Studio. Columbin interaction with the glutathione S-transferases (GSTs), a receptor protein (PDB 5ft3). It has high binding affinity. Hydrophobic regions were represent as red and Hydrophilic regions were represent as blue line model. Ligands binding predicted using AutoDock. Protein residues (blue line) and ligand (green color) are represented by thin and sticks, respectively. Ligand binding regions are represented as ball and stick model. Hydrogen bonds are shown in yellow dashed solid lines, respectively. Fig.2 and Table 2. Ligand columbin interaction with the receptor glutathione S-transferase respectively. The software's docked pose of the glutathione S transferase E and Columbin receptors was shown in Figure 3. Columbin was discovered to engage more strongly with the glutathione s transferase receptor than any other studied ligand, exhibiting a higher docking score and the ability to generate H bonds. Glutathione S-transferases (GSTs) active sites were predicted using Discovery studio visualizer. The structure-based drug design approach includes the docking of small molecule compounds into receptor binding sites and the estimation of the complex's binding affinity. An open-source tool for drug discovery, molecular docking, and virtual screening called AutoDock Vina has multicore support, excellent performance, improved accuracy, and user-friendliness. When the structure of the ligand-protein complex is known, the docking tool's capacity to replicate the ligand-protein binding mode can be used to evaluate the parameters that were selected. Through the use of *in silico* docking, the molecules with known structures is found. They forecasts ligand-receptor optimal orientation in order to build a stable complex [10,11]. For every docked result in the molecular docking investigation, cluster analysis was carried out using a root mean square deviation of 2M. In most docking programs, the top-ranked pose with the lowest docked binding affinities is typically selected as a standard pick. Currently, molecular docking research is emerging as a unique method for examining how different proteins interact with ligands, aiding in the deciphering of the structure-function relationship and the development of logical drug designs [12]. Phase II detoxification enzymes called glutathione transferases are recognized to be essential for the body's system to detoxify different xenobiotics







Antony Annammal et al.,

[13].Therefore, these compounds can be utilized as glutathione transferase inhibitors because they are nontoxic and have a high binding affinity. In addition to determining how a ligand and receptor interact, computational docking methods may also determine if a medication can be synthesized from a wide range of chemical databases[14,15].The current findings are in line with previously released docking data, which indicated that binding energies might be regarded as encouraging outcomes[16,17].Columbin has best binding energy affinity of when docked with Glutathione S transferase E. It symbolizes the development of strong H-bonds between the receptor and the ligand.

The recombinant Glutathione s transferase epsilon 2 enzyme from *Aedes aegypti*, however, differs from its Anopheles counterpart in that it displays amounts of glutathione comparable to other insect GSTs in terms of peroxidase activity that participate in lipid peroxidation's conjugation end product[18,19].Thus it is used as an insecticide Glutathione s transferase epsilon 2 enzyme could play a significant role in detoxifying oxidative stress defence system and may consequently acting as a second line of defence in the battle against the harmful effects of insecticides. AaGSTE2 docking investigations against DDT and DDE have previously been completed [20].Insecticide in the Anopheles mosquito had also been docked against other detoxifying enzyme groups. Development of particular inhibitors may benefit greatly from the knowledge of detox enzymes' interactions with insecticides. These enzymes are interesting candidates for developing novel technological instruments like biosensors for the immediate monitoring of contaminants in the environment, such as pesticides. Despite larvicidal effect and in silico analysis demonstrated that AaGSTE2 enzymes may be involved in the detoxification of compounds.

## CONCLUSION

In silico docking has proven to be an incredibly valuable tool for investigating glutathione s transferase, particularly in the context of chemical insecticide resistance. The complexes developed help to improve understanding of the detoxification process carried out by these enzymes. These glutathione s transferase enzyme, as promiscuous proteins, may be implicated in the metabolization of a wide variety of hazardous chemicals, including various insecticides. Because insecticide resistance is a major constraint in mosquito control, the findings of this study could be extremely useful in developing specific inhibitors for these GSTs, reducing the amount of insecticides used and, as a result, the environmental impact and other side effects. While the primary focus has been on their response to insecticides, there is emerging evidence suggesting that these enzymes may also be involved in the detoxification of plant compounds, including the secondary metabolite columbin. The adaptation of *Aedes aegypti* mosquitoes to plant-derived toxins highlights the complexity of their ecological interactions with plants in their environment. It warranted the specific mechanisms GST enzymes in *Aedes aegypti* mosquitoes interact with plant compounds, contributing to our understanding of mosquito ecology and potential implications for vector control strategies.

## ACKNOWLEDGEMENT

I thank the co-authors for their extensive knowledge in the field and their ability to provide critical feedback throughout the writing process. Their guidance and suggestions have greatly enhanced the overall quality of the paper. I would like to acknowledge the invaluable contributions and their expertise in the subject matter in refining our arguments and providing alternative perspectives.

## REFERENCES

1. Fan, S.; Chang, J.; Zong, Y.; Hu, G.; Jia, J. GC-MS Analysis of the Composition of the Essential Oil from *Dendranthema indicum* Var. Aromaticum Using Three Extraction Methods and Two Columns. *Molecules* **2018**, *23* (3), 1–11. DOI: 10.3390/molecules23030576
2. Razack, S.; Kumar, K. H.; Nallamuthu, I.; Naika, M.; Khanum, F. Antioxidant, Biomolecule Oxidation Protective Activities of *Nardostachys jatamansi* DC and Its Phytochemical Analysis by RP-HPLC and GC-MS. *Antioxidants* **2018**, *4*, 185–203.





**Antony Annammal et al.,**

3. Upadhyay, A. K.; Kumar, K.; Kumar, A.; Mishra, H. S. *Tinospora cordifolia* (Willd.) Hook. f. and Thoms. (Guduchi) – Validation of the Ayurvedic Pharmacology through Experimental and Clinical Studies. *Int. J. Ayurveda Res.* **2010**, *1* (2), 112–121. <https://doi.org/10.4103/0974-7788.64405>
4. Saeed, M.; Naveed, M.; Leskovec, J.; Kakar, I.; Ullah, K.; Ahmad, F., et al. Using Guduchi (*Tinospora cordifolia*) as an Eco-friendly Feed Supplement in Human and Poultry Nutrition. *Poult. Sci.* **2020**, *99* (2), 801–811. DOI: 10.1016/j.psj.2019.10.051
5. Ding, Y.; Ortelli, F.; Rossiter, L. C.; Hemingway, J.; Ranson, H. The *Anopheles gambiae* Glutathione Transferase Supergene Family: Annotation, Phylogeny and Expression Profiles. *B.M.C. Genomics* **2003**, *4* (1), 35. DOI: 10.1186/1471-2164-4-35
6. Tu, C. P. D.; Akgül, B. *Drosophila* Glutathione S-transferases. *Method. Enzymol.* **2005**, *401*, 204–226. DOI: 10.1016/S0076-6879(05)01013-X
7. Lumjuan, N.; Stevenson, B. J.; Prapanthadara, L. A.; Somboon, P.; Brophy, P. M.; Loftus, B. J.; Severson, D. W.; Ranson, H. The *Aedes aegypti* Glutathione Transferase Family. *Insect Biochem. Mol. Biol.* **2007**, *37* (10), 1026–1035. DOI: 10.1016/j.ibmb.2007.05.018
8. Lipinski, C. A.; Lombardo, F.; Dominy, B. W.; Feeney, P. J. Experimental and Computational Approaches to Estimate Solubility and Permeability in Drug Discovery and Development Settings. *Adv. Drug Deliv. Rev.* **2001**, *46* (1–3), 3–26. DOI: 10.1016/S0169-409X(00)00129-0
9. Suri, C.; Naik, P. K. Elucidating the Precise Interaction of Reduced and Oxidized States of Neuroglobin with Ubc12 and Cop9 Using Molecular Mechanics Studies. *Int. J. Fundam. Appl. Sci.* **2012**, *1* (4), 74–77.
10. Brooks, B. R.; Brooks, C. L., Mackerell AD, Nilsson L, Petrella RJ, Roux B, et al. CHARMM: The bio-molecular simulation program. *Comput Chem* 2009;30(10):1545-615.
11. Madeswaran, A.; Umamaheswari, M.; Asokkumar, K.; Sivashanmugam, T.; Subhadradevi, V.; Jagannath, P. Computational Drug Discovery of Potential Phosphodiesterase Inhibitors Using *In Silico* Studies. *Asian Pac. J. Trop. Dis.* **2012**, *2* (2), S822–S826. DOI: 10.1016/S2222-1808(12)60272-2
12. Mavromoustakos, T.; Durdagi, S.; Koukoulitsa, C.; Simcic, M.; Papadopoulos, M. G.; Hodosecek, M.; Grdadolnik, S. G. Strategies in the Rational Drug Design. *Curr. Med. Chem.* **2011**, *18* (17), 2517–2530. DOI: 10.2174/092986711795933731
13. Alias, Z.; Clark, A. G. Adult *Drosophila melanogaster* Glutathione S-Transferases: Effects of Acute Treatment with Methyl Parathion. *Pestic. Biochem. Physiol.* **2010**, *98* (1), 94–98. DOI: 10.1016/j.pestbp.2010.05.005
14. Patel, L.; Shukla, T.; Huang, X.; Ussery, D. W.; Wang, S. Machine Learning Methods in Drug Discovery. *Molecules* **2020**, *25* (22), 5277. DOI: 10.3390/molecules25225277
15. Gupta, R.; Srivastava, D.; Sahu, M.; Tiwari, S.; Ambasta, R. K.; Kumar, P. Artificial Intelligence to Deep Learning: Machine Intelligence Approach for Drug Discovery. *Mol. Divers.* **2021**, *25* (3), 1315–1360. DOI: 10.1007/s11030-021-10217-3
16. Wang, G. C.; Peng, Y. P.; Xie, Z. Z.; Wang, J.; Chen, M. Synthesis,  $\alpha$ -Glucosidase Inhibition and Molecular Docking Studies of Novel Thiazolidine-2,4-Dione or Rhodanine Derivatives. *Medchemcomm* **2017**, *8* (7), 1477–1484. DOI: 10.1039/c7md00173h
17. Ur Rehman, N. U.; Rafiq, K.; Khan, A.; Ahsan Halim, S.; Ali, L.; Al-Saady, N.; Hilal Al-Balushi, A.; Al-Busaidi, H. K.; Al-Harrasi, A.  $\alpha$ -Glucosidase Inhibition and Molecular Docking Studies of Natural Brominated Metabolites from Marine Macro Brown Alga *Dictyopteris hoytii*. *Mar. Drugs* **2019**, *17* (12), 666. DOI: 10.3390/md17120666
18. Vontas, J. G.; Small, G. J.; Hemingway, J. Glutathione S-Transferases as Antioxidant Defence Agents Confer Pyrethroid Resistance in *Nilaparvata lugens*. *Biochem. J.* **2001**, *357* (1), 65–72. DOI: 10.1042/0264-6021:3570065
19. Singh, S. P.; Coronella, J. A.; Benes, H.; Cochrane, B. J.; Zimniak, P. Catalytic Function of *Drosophila melanogaster* Glutathione S-transferase DmGSTS1-1 (GST-2) in Conjugation of Lipid Peroxidation End Products. *Eur. J. Biochem.* **2001**, *268* (10), 2912–2923. DOI: 10.1046/j.1432-1327.2001.02179.x
20. Setzer, W. N. The Molecular Mechanism for DDT Detoxification in *Anopheles gambiae*: A Molecular Docking Study. *J. Biol. Phys. Chem.* **2011**, *2*, 134–135.





Antony Annammal et al.,

Table.1 Phytochemicals identified in the stem extract of *Tinospora cordifolia* by GC-MS analysis


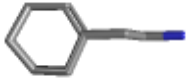
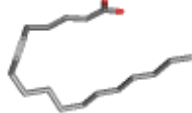

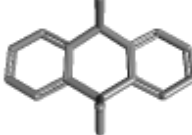

S.No	Name of the compound	Retention Time	Molecular Formulae	Molecular weight	Area (%)	Cas No	Molecular structure
1	12-Oxododecanoic acid, ethyl ester	11.958 min	C <sub>14</sub> H <sub>26</sub> O <sub>3</sub>	242.36 g/mol	4.35	151271-75-9	
2	2-(1-Cyclohexenyl)ethylamine	13.528 min	C <sub>8</sub> H <sub>15</sub> N	125.21	3.77	003399-73-3	
3	6-Octadecenoic acid, (Z)-	13.575 min	C <sub>18</sub> H <sub>34</sub> O <sub>2</sub>	282.5	5.54	000593-39-5	
4	Columbin	17.386 min	C <sub>20</sub> H <sub>22</sub> O <sub>6</sub>	358.4	67.63	000546-97-4	
5	Anthracene, 9-ethyl-9,10-dihydro-9,10-dimethyl-	17.896 min	C <sub>18</sub> H <sub>20</sub>	236.4	12.10	054947-86-3	
6	Benz[b]-1,4-oxazepine-4(5H)-thione, 2,3-dihydro-2,8-dimethyl-	18.312 min	C <sub>11</sub> H <sub>13</sub> NO <sub>2</sub> S	207.29	6.60	1000258-63-4	

Table. 2 This table shows docking interaction with binding affinity at different position

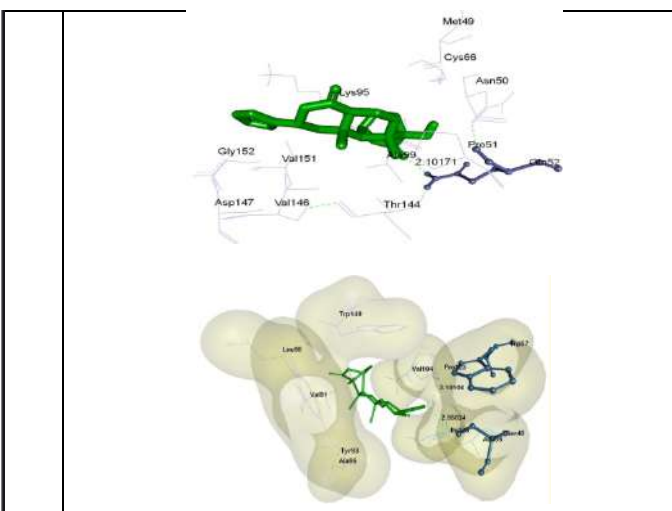
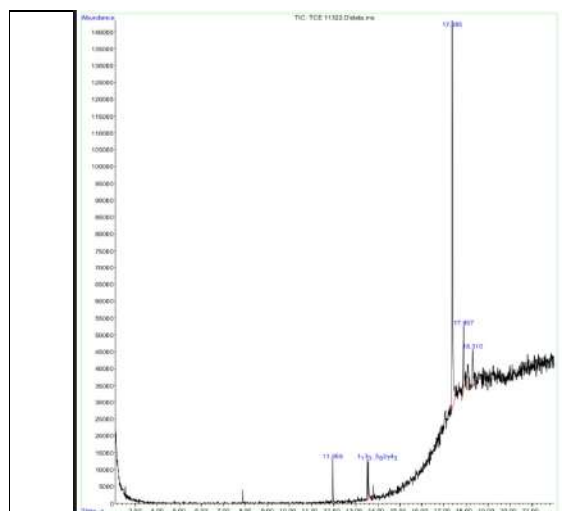
S.NO	Mode	Binding Affinity	RMSD Lower bound	RMSD Upper bound
1	0	-8.9	0.0	0.0
2	1	-8.7	27.434	31.189
3	2	-8.5	2.837	4.625
4	3	-8.1	30.953	35.385
5	4	-8.0	26.924	30.668





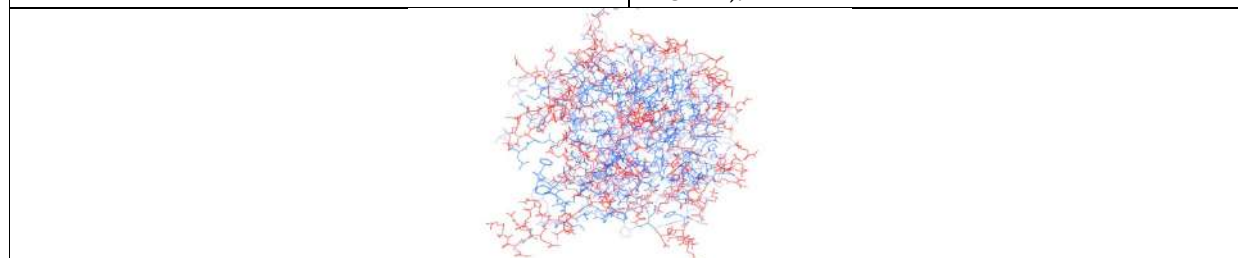
**Antony Annammal et al.,**

6	5	-7.9	26.892	3.431
7	6	-7.8	1.978	6.865
8	7	-7.8	29.894	33.864
9	8	-7.2	31.043	35.155



**Figure. 1** GC-MS chromatogram of stem extract of *Tinopora cordifolia*

**Figure.2** Ligands binding predicted using AUTODOCK. Protein residues (blue line) and ligand (green color) are represented by thin and sticks, respectively. Ligand binding regions are represented as ball and stick model. Hydrogen bonds are shown in yellow dashed solid lines, (Source: PDB, PyRx & BIOVIA).



**Figure.3** Receptor protein (PDB 5ft3) structure Hydrophobic regions were represent as red and Hydrophilic regions were represent as blue line model.





## Antecedents and Consequences of Employees' Perceived Workplace Safety: A Study of Chemical Industries in SIPCOT, Tamil Nadu

D.Nandhini<sup>1\*</sup> and T.Frank Sunil Justus<sup>2</sup>

<sup>1</sup>Research Scholar, Department of Business Administration, Annamalai University, Chidambaram, Tamil Nadu, India.

<sup>2</sup>Associate professor, Department of Business Administration, Annamalai University, Chidambaram, Tamil Nadu, India.

Received: 30 Jan 2024

Revised: 09 Feb 2024

Accepted: 27 Apr 2024

### \*Address for Correspondence

**D.Nandhini**

Research Scholar,

Department of Business Administration,

Annamalai University,

Chidambaram, Tamil Nadu, India.

Email: jho.bio@gmail.com



This is an Open Access Journal / article distributed under the terms of the **Creative Commons Attribution License** (CC BY-NC-ND 3.0) which permits unrestricted use, distribution, and reproduction in any medium, provided the original work is properly cited. All rights reserved.

### ABSTRACT

This abstract emphasizes the significance of workplace safety for the well-being of employees and the longevity of businesses. The safety of employees in the workplace is not only a moral obligation but also a crucial factor in the sustainability of any business. In this abstract, we underscore the critical importance of prioritizing workplace safety to ensure the well-being of your employees and safeguard the future of your organization. Rooted in legal and moral obligations, safeguarding employees becomes imperative, particularly in industries with inherent risks such as the chemical sector. Despite global advancements, persistent hazards necessitate proactive measures to enhance occupational health and safety standards. The study aims to contribute to this endeavor by exploring employee perceptions of safety in chemical companies within SIPCOT industrial complexes in Tamil Nadu. The conceptual framework integrates four key factors – psychological capital, empowering leadership, workplace social capital, and organizational reputation – identified as potential antecedents influencing employees' perception of workplace safety. Psychological capital is expected to shape employees' interpretations of safety-related aspects while empowering leadership fosters a safety-conscious culture. Workplace social capital influences shared understanding and adherence to safety norms, and organizational reputation impacts the perceived importance of safety measures. This comprehensive framework aims to unravel the determinants of employees' perception of workplace safety in the chemical industries of SIPCOT, Tamil Nadu.



**Nandhini and T.Frank Sunil Justus**

**Keywords:** Psychological capital, empowering leadership, workplace social capital, organizational reputation, workplace safety, employee perception.

## INTRODUCTION

Ensuring the safety and well-being of employees in the workplace is not only a legal requirement but also a crucial component contributing to the overall success and sustainability of businesses. Neglecting safety measures in the workplace can have serious consequences. Therefore, it is of utmost importance to prioritize safety. (Acakpovi and Dзамikumah, 2016). In modern workplaces, ensuring safety goes beyond following regulations; it involves prioritizing the well-being of both employees and employers. Organizations have a moral and legal responsibility to provide a safe work environment for their employees. This requires proactive measures to identify and mitigate potential hazards. Creating a secure workplace not only fulfills this obligation but also promotes positive and productive work culture. In certain industries, like the chemical sector, there are inherent occupational risks that make the obligation to ensure safety even more essential. Since the industrial revolution of the 1800s, the understanding and implementation of health and safety measures have significantly evolved over time. Workplace safety continues to improve worldwide, with a consistent decrease in fatalities and injuries (Cameron, 2021). The International Labour Organization (ILO) defines occupational health and safety as the preservation of the highest degree of physical, mental, and social well-being of workers, underscoring the importance of protection from work-related risks (ILO, 2001). The difference between health and safety is critical in the context of work, where health concerns the protection of individuals' physical and mental well-being from work-related materials and processes, while safety ensures protection from physical harm. (Hughes and Ferret, 2008). A strong occupational health and safety framework is not just a moral and legal obligation, but it also has significant implications for business operations, cost management, and organizational reputation. Despite safety advancements, many jobs and countries still pose significant health hazards to workers, compromising their well-being and life expectancy.

Workplace accidents can have a significant impact on society and the economy. To prevent such accidents, it is essential to take proactive measures to improve health and safety standards. Effective occupational health and safety management is a complex solution that involves moral, legal, and business aspects. This study is inspired by the importance of workplace safety and aims to explore employees' perceptions of safety in chemical companies located within various SIPCOT industrial complexes in Tamil Nadu. By addressing employee perceptions, the study seeks to contribute to the ongoing efforts to enhance the safety culture and climate within these organizations. The research focuses on four main factors that affect employees' perception of workplace safety: psychological capital, empowering leadership, workplace social capital, and organizational reputation. Psychological capital involves traits like resilience, optimism, hope, and self-efficacy, which play a crucial role in shaping how employees interpret and respond to safety-related aspects in their work environment. Empowering leadership, which fosters autonomy, trust, and employee development, is expected to contribute significantly to creating a safety-conscious culture within the organization. The network of relationships and social interactions among employees, known as workplace social capital, is also believed to influence the shared understanding and adherence to safety norms. In addition, the reputation of an organization, which reflects its perceived image, is likely to influence how employees view the importance of safety measures implemented by the company. These factors, when combined, create a comprehensive framework for analysing the factors that shape employees' perception of workplace safety in the chemical industries of SIPCOT, Tamil Nadu.

### Motivation behind the Study

An investment in a safety management system that focuses on hazard identification, training, prevention and assessment will not only help reduce losses and increase overall safety compliance records, but it could be the difference between being an industry leader or just another run-of-the-mill sub-standard company. A high level of occupational health and safety not only enhances the reputation, economic status, financial performance and



**Nandhini and T.Frank Sunil Justus**

profitability of the company, it improves the employee commitment and safety culture. Reduced hazards and increased safety substantially reduce accident injuries and deaths which directly influences the well-being, working capacity and longevity of workers. Studies have showed that when employees perceive that safety is not a priority of the company, their behaviour and attitudes are adversely affected. This can be a recipe for disaster leading to increased workplace injuries, lower morale and decreased profitability. Hence, it essential for the company to focus on employees and listen to them when it comes to safety management. Because it's the workers on the field who are in the line of fire when working in hazardous industries. The management should consult with their employees and understand the safety concerns and requirements in their day-to-day work. It is essential to regularly assess the safety climate of the company which is indicated by the employees' perception on importance of safety at workplace. Understanding their safety perceptions and implementing employee-oriented strategies can help in significant improvement of their work quality, productivity and profitability of the company. Inspired by this notion, this study aims to undertake the employee perception survey of workplace safety across various chemical companies in SIPCOT, Tamil Nadu.

**RESEARCH OBJECTIVE**

To examine the antecedents and consequences of employee perception of workplace safety in chemical industries in SIPCOT, Tamil Nadu. Specifically, the study aims to

- Examine the effect of psychological capital, empowering leadership, workplace social capital and organizational reputation on the employees' perception of workplace safety.
- Examine the effect of employees' perception of workplace safety on job stress and employee engagement.

**LITERATURE REVIEW AND HYPOTHESES DEVELOPMENT**

Psychological capital is characterized as an individual's positive psychological state of development, serving as an indicator of employees' strength, psychological capacity, and motivational predisposition. This construct encompasses four positive psychological attributes: efficacy, optimism, hope, and resilience (Avey et al., 2009; Luthans et al., 2007). These psychological resources play a significant role in enhancing employees' job satisfaction and performance (Luthans et al., 2007), This reservoir of psychological resources contributes to improved job satisfaction and performance. Empowering leadership serves as a crucial antecedent to safety, fostering a culture where employees are granted decision-making authority and autonomy, thereby contributing to enhanced workplace safety attitudes and behaviours. Empowering leaders distribute decision-making authority among their subordinates, sharing power and expressing confidence in their ability to perform tasks independently (Spreitzer, 1995). This approach makes empowering leadership a promising strategy for leaders to positively influence employee attitudes and behaviours (Oreg and Berson, 2011). The expression of confidence in employees' abilities to perform tasks independently further solidifies empowering leadership as a foundational element influencing safety outcomes. The quality of social connections fosters a safer and more secure work environment, emphasizing the role of social capital in workplace safety. Social capital refers to the norms of reciprocity and trust, formal and informal associations, and civic participation that enable collective action for mutual benefit (McKenzie et al., 2002). It is the resources accessed through social networks (Kawachi et al., 2008). The job or workplace serves as a significant social context, occupying a considerable portion of time and life for working-age adults (Kawachi et al., 1999). A strong organizational reputation reinforces a safety-oriented culture, influencing employees to prioritize and adhere to safety protocols. Hence, an organization's reputation is established based on its historical conduct and affiliations but can swiftly transform with the emergence of new information or if recent actions are incongruent with observers' expectations (Lange et al., 2011). Capturing this essence, Buffet (1995) succinctly noted, "It takes twenty years to build a reputation and five minutes to ruin it." Employees' positive perception of workplace safety is associated with lower job stress, fostering a work environment that reduces stressors and promotes overall well-being. Conversely, a negative perception may elevate job stress, emphasizing the consequential impact of safety perceptions on



**Nandhini and T.Frank Sunil Justus**

employees' stress levels. Xie (2016) characterized job stress as a sequence of physiological, psychological, and behavioural reactions arising from persistent exposure to workplace stressors. As per Salami (2010), job stress entails the encounter of adverse emotions like anxiety, anger, frustration, and depression stemming from work-related factors. Positive employee engagement is closely tied to their perception of workplace safety, fostering a culture where employees actively contribute to and prioritize safety measures. Employee engagement typically signifies the emotional and intellectual dedication to the organization (Baumruk 2004; Richman 2006; Shaw 2005) or the level of additional effort employees willingly invest in their work (Frank et al., 2004). When employees feel engaged, they are more likely to embrace safety protocols, creating a synergistic relationship between engagement and a safety-conscious work environment. The extensive review of literature on workplace safety in the industrial context revealed that there are limited empirical studies which validate the various antecedents and consequences of employee perception of workplace safety. Besides, the past studies have never specifically focused on a cluster of chemical companies located in SIPCOT, Tamil Nadu. These research gaps served as inspiration and emphasized the need for this study. Since the study focuses on employee perception of workplace safety, it constitutes the central construct of the conceptual framework. The antecedents and consequences of employees' perception of workplace safety were hypothesized based on extant literature and theories as well as expert consultation.

Based on an extensive literature review, this study focused on the effect of personal and organizational characteristics such as psychological capital, empowering leadership, workplace social capital and organizational reputation. These four constructs were incorporated as the antecedents of employees' perception of workplace safety in the conceptual framework. About the outcomes, job stress and employee engagement were hypothesized as the two consequences of employees' perception of workplace safety. Thus, the proposed conceptual framework consisted of seven constructs i.e., employees' perception of workplace safety, psychological capital, empowering leadership, workplace social capital, organizational reputation, job stress and employee engagement. The interrelationships between the constructs were hypothesized based on existing theories and literature review. The following hypotheses of relationships were formulated which were eventually tested during the validation of the conceptual framework. The psychological capital of employees representing their positive psychological state is an indicator of their psychological strength, capacity and motivational predisposition at the workplace (Avey et al., 2009; Luthans et al., 2007). According to the Job Demands-Resources theory (Bakker & Demerouti, 2007), psychological capital is an effective personal resource of employees which facilitates better management of job demands and stressors such as work pressure, risky and hostile work environment (Avey et al., 2009) typically observed in chemical industry jobs. According to Bergheim et al. (2015), employees with high psychological capital are goal-oriented and confident with strong ability to adjust and cope with hardships. Given the very nature and inherent dangers of their workplace, such psychologically strong employees will focus on their work performance including safety involvement, behaviour and management. To test this, the following hypothesis was formulated:

**H1: Employees' psychological capital has a positive effect on their perception of workplace safety**

Employees with high psychological capital feel more resourceful, empowered and effectively cope with job demands and stress (Avey et al., 2009; 2011). According to broaden-and-build theory, positive emotions help broaden people's thought-action repositories, widen the array of thoughts and actions that occur in their minds, and provide a positive outlook towards a situation (Bakker and Demerouti, 2008; Fredrickson, 2001), thereby helping them avoid high stress (Siu et al., 2014). Hence, high psychological capital enhances employees' confidence in their beliefs, hope, optimism and resilience in the face of obstacles, are less likely to report job stress (Abbas and Raja, 2015). Consequently, the following hypothesis was formulated:

**H2: Employees' psychological capital has a negative effect on their job stress**

Empowering leadership defined as "sharing power with a view toward enhancing employees' motivation and investment in their work" (Zhang and Bartol, 2010) is a promising strategy for leaders to positively shape employee attitudes and behaviours (Oreg and Berson 2011). Past research on the leadership-workplace safety relationship predominantly focused on the effect of safety leadership or specifically transformational leadership on employees' safety climate perception, safety participation and behaviour (Zao et al., 2022; Draghici et al., 2022). However, hardly





**Nandhini and T.Frank Sunil Justus**

any studies focused on empowering leadership which has stronger motivational element that influences employees' behaviour than other leadership styles like transformational or transactional leadership. Although transformational leadership also stirs motivation within employees through its charismatic and idealized influences, the leader motivates employees through speech rather than behaviour (Lee and Ding, 2020). In empowering leadership, the leader encourages employees through his or her behaviour, which allows employees to experience higher levels of connectedness, appreciation, and motivation (Kwak and Jackson, 2015). To validate this relationship, the following hypothesis was formulated:

**H3: Empowering leadership has a positive effect on employee perception of workplace safety**

The Job Demands-Resources (JD-R) model states that that employee engagement is a consequence of better organizational support and a conducive working environment. Thus, work engagement results from superior job resources (Bakker & Demerouti, 2007). Job resources refers to those physical, psychological, social or organizational aspects of the job that may: (a) be functional in achieving work goals; (b) reduce job demands at the associated physiological and psychological costs; (c) stimulate personal growth development. (Demerouti et al., 2001). Empowering leaders are one such effective social and organizational resource who focus on employee well-being and facilitate healthy leader-employee relationship, giving sub-ordinates more autonomy and vitality, and helping to increase their job satisfaction by relieving job stress and burnout (Liu et al., 2021). To test this impact of empowering leadership on employees' stress level, the following hypothesis was formulated:

**H4: Empowering leadership has a negative effect on employees' job stress**

Empowering leadership can be described as leader behaviours where power is shared with subordinates and that raise their level of intrinsic motivation (Srivastava et al., 2006). When subordinates are given freedom and autonomy, they are motivated to be more proactive and emotionally engaged in their job (Lee et al., 2016). Tuckey et al. (2012) found a significant relationship between empowering leadership and work engagement. Consequently, the following hypothesis was formulated:

**H5: Empowering leadership has a positive effect on employee engagement**

Workplace social capital represents the collective value of the employees, their networks and their interactions. Past research on safety climate antecedents have commonly focussed on the relationship between senior management or leadership and employees, with factors such as communication, trust, leader-member exchange and organizational support receiving more attention (Hofmann and Stetzer 1996; Zohar, 2000; Watson et al. 2005; Tang et al., 2013). While these antecedents are properties of workplace social capital, very few studies incorporated and tested the effect of social capital on employees' safety perceptions (Tang et al., 2014). To further validate this relationship, the following hypothesis was formulated:

**H6: Workplace social capital has a positive effect on employee perception of workplace safety**

Past research on social capital at the workplace has established a positive relationship with employees' health-related outcomes such as stress, depression and mental health (Poortinga, 2006; Sapp et al., 2010; Boyas et al., 2012; Gao et al., 2014). Social capital is recognized to promote health through several mechanisms such as strengthening an individual's ability to cope with stress, acting as per norms within a group and boosting an individual's ability to participate in collective action for other members' benefits (Firouzbakht et al., 2018). To test the influence of workplace social capital on job stress, the following hypothesis was formulated:

**H7: Workplace social capital harms employees' job stress**

According to Oksanen et al. (2010), organizations with high social capital have happier, healthier, more satisfied and productive employees making it a significant social resource at workplace. Similar to leadership and organizational support, according to JD-R theory (Bakker and Demerouti, 2007), past research has established workplace social capital as a crucial job resource predicting employee engagement (Fujita et al., 2016; Marcus et al., 2016; Meng et al., 2018). Hence, the following hypothesis was formulated:



**Nandhini and T.Frank Sunil Justus****H8: Workplace social capital has a positive effect on employee engagement**

Weigelt and Camerer (1988) defined reputation as a set of attributes ascribed to an organization, inferred from its past actions which exist in the minds of the observer (Clark and Montgomery, 1998). In this study, organizational reputation is conceptualized as the sum of impressions about the organization's established image in the minds of its employees. Barling and Hutchinson (2000) found that occupational safety reputation influences employees' safety climate perception. Another analogous study was conducted by Mira et al. (2013) in the healthcare industry where hospital's social reputation had a positive relationship with perceived patient safety. To test the impact of a chemical company's reputation as a whole on employees' workplace safety perception, the following hypothesis was formulated:

**H9: Organizational reputation has a positive effect on employee perception of workplace safety**

Perceived organizational reputation is the overall employee evaluation of the organization over time (Men, 2012). While majority of past studies linking corporate reputation and employee behaviour focus on the later driving corporate reputation (Friedman, 2009; Helm, 2011), very few researchers posit that corporate reputation affects the way employees behave and perform (Davies et al., 2004; Men, 2012; Shirin and Kleyn, 2017). This study postulates that employees perceived organizational reputation of a chemical industry affects their performance and engagement in their work. To validate this, the following hypothesis was formulated:

**H10: Organizational reputation has a positive effect on employee engagement**

The transactional model of Stress and Coping proposed by Lazarus and Folkman (1987) states that stress is experienced as an appraisal (an evaluation) of the situation we find ourselves in. Stress is a dynamic process resulting from the complex interaction between an individual and his/her environment. Thus, exposure to risk at workplace lead to increased stress among employees (Berry and Kim, 1988; Lazarus and Folkman, 1984), which eventually impacts their health and well-being. Past research shows that very few studies have theorized and established that workplace safety measures create environment that reduce job stress of employees (Ramos et al., 2021). To validate this, the following hypothesis was formulated:

**H11: Employee perception of workplace safety has a negative effect on their job stress**

The Social Exchange Theory and norm of reciprocity in the employee-management relationship is widely applied in organizational psychology research. The theory states that perception of organizational support and care for well-being of the employees create an obligation among employees to return favour to the organization and perform better (Eisenberger et al., 2002). In the context of safety climate, safety practices and management's commitment to safety constitute as part of social exchange dynamics such that employees behave positively when they perceive superior workplace safety (Dejoy et al., 2010; Huang et al., 2016). Thus, employees exhibit greater commitment and engagement in their work when they perceive lower stress and higher workplace safety. To validate this, the following hypotheses were formulated:

**H12: Employee perception of workplace safety has a positive effect on employee engagement****H13: Employees' perceived job stress has a negative effect on employee engagement**

The conceptual framework developed for this study consisting of the seven constructs and their hypothesized interrelationships is presented in Figure 1.

**RESEARCH METHODOLOGY****Study Area**

This study was conducted in Tamil Nadu which is one of the most industrialized states. Its manufacturing sector accounts for more than one-third of the state's gross product. Production of heavy vehicles such as automobiles, agricultural equipment, military vehicles, and railway cars is among the state's major industries. Other prominent industries include chemicals, pharmaceuticals, textile milling, food processing and electronic equipment. This study



**Nandhini and T.Frank Sunil Justus**

focused on companies in State Industries Promotion Corporation of Tamil Nadu Ltd, popularly known as SIPCOT industrial complexes in Tamil Nadu since it houses large industries from various sectors, unlike Small Industries Development Corporation (SIDCO) focusing only on small industries and Tamil Nadu Industrial Development Corporation (TIDCO) facilitating industrial and infrastructure projects through joint ventures with private organizations. SIPCOT was established in the year 1971 to develop industrial growth in Tamil Nadu. The objective of SIPCOT is to establish, develop, maintain and manage industrial complexes, parks and growth centres at various places across the State of Tamil Nadu.

**Study Context**

Though SIPCOT houses different types of industries where safety is of equal importance, this study focused on the workplace safety in the context of chemical industries given its specific nature. The rationale behind choosing a single industry for this study was that safety hazards, risks, measures and management significantly varies based on the industry. Considering all major sectors such as automobile, chemical, electronics and textile industries operating in SIPCOT would have made it highly complicated to cover the safety aspects of all industries and coerced the researcher to render it into highly generic research on workplace safety across all industries in SIPCOT. Hence, the researchers selected the study context as chemical industry since it is perceived to be more dangerous with considerably higher safety risks and hazards compared to other industries in SIPCOT.

**Sampling Procedure**

This study adopted the multi-stage sampling technique which is often regarded as an extended version of cluster sampling. The first stage involved selecting the SIPCOT industrial complexes, the second stage involved shortlisting the chemical companies in the selected SIPCOT industrial complexes, and the third stage involved choosing employees working in these selected chemical companies for data collection. There are 20 SIPCOT industrial complexes/parks presently operating in various places in Tamil Nadu. In the first stage, three SIPCOT industrial parks were selected through purposive sampling techniques such as that they are spread across Tamil Nadu and housed large chemical companies. The three SIPCOT complexes were the Gummidipoondi industrial complex located in the northern region of Tamil Nadu near Chennai, the Cuddalore SIPCOT industrial complex located in the eastern region of Tamil Nadu and the Tuticorin SIPCOT industrial complex situated in the southern part of Tamil Nadu. These three SIPCOT industrial complexes housed some of the major chemical companies in the state. In the second stage, chemical companies were selected from each of these three SIPCOT industrial complexes through a purposive sampling technique based on the criterion that the permanent employee strength was at least 50. The list of chemical companies selected in the second stage is presented in Table 1. In the final stage, the researcher employed convenience sampling technique which focuses on collecting data from respondents who are convenient for the researcher to access. Since gaining access and permission to interact with the employees in the premises of various chemical companies was not feasible, the researcher adopted the convenience sampling which involved intercepting employees coming out of the company after their shift as well as contacting them in their residential places.

**Data Collection Tool**

A structured questionnaire was constructed to capture employees' perceived workplace safety and its antecedents and consequences hypothesized in the conceptual framework. The constructs were primarily measured using popular established scales from widely-cited studies which were modified to suit this study context as presented in Table 2. Two university professors assessed the content validity of the measurement scales which involved checking the items for relevance and eliminating inappropriate and redundant items. A pilot study was conducted on a small sample of 50 respondents to check the reliability and validity of the adopted measurement scales. The responses for the statements were recorded using the 5-point Likert scale (1-strongly disagree, 5-strongly agree). The final list of measures with scale items used in this study is presented in Appendix.

**Data Collection Procedure and Sample Size**

During data collection, the researcher approached the employee one by one, explained them the study and asked if they were interested to participate anonymously. If yes, they were requested to fill the questionnaire. Participation of



**Nandhini and T.Frank Sunil Justus**

the employees was completely voluntary and there were no incentives. The data were collected over a period of six months from April to August 2023 in the three SIPCOT locations i.e., Gummidipoondi, Cuddalore and Tuticorin. Of the 585 administered questionnaires, 534 valid responses were obtained and this number is well above the minimum recommended sample size of 384 required to achieve the desired level of precision and confidence in this study. The profile of the respondents based on their companies, demographic and job characteristics is presented in Table 3, 4 and 5.

**Data Analysis and Interpretation**

The study adopted Anderson and Gerbing's (1988) two-step modelling approach which involved an initial Confirmatory Factor Analysis (CFA) to confirm the psychometric properties of the adopted scales followed by Structural Equation Modelling (SEM) to validate the proposed conceptual framework.

**Confirmatory Factor Analysis**

The 534 set of responses collected for 47 items were subjected to CFA in SPSS AMOS v26 to assess the psychometric properties of the scales adopted in this study. The measurement model with seven factors and 40 items was built and estimated using maximum likelihood (ML) estimation method. The results showed that the standardized factor loadings of seven items were below 0.5 and their squared multiple correlations (SMCs) ranged from 0.11 to 0.23 indicating their abysmal contribution to their corresponding dimensions which affected the model fit. Hence, they were eliminated from further analysis. The measurement model with remaining 40 items was again estimated and the seven-factor solution obtained had adequate model fit ( $\chi^2 = 2142.08$ ,  $p = .00$ ; GFI = .83; CFI = .902; NFI = .859; IFI = .902; RMSEA = .055) (Schermelleh-Engel et al., 2003). The factor loadings of the items ranged from 0.648 to 0.974 and the SMCs ranged from 0.343 to 0.818. Hence, no further items were removed. The measurement model built during CFA is presented in Figure 2. The convergent validity and reliability of the scales were assessed using Average Variance Extracted (AVE) and Composite Reliability (CR). The AVE estimates of the scales ranging from 0.457 to 0.785 were above the required threshold of 0.5 and the CR values ranging from 0.833 to 0.956 were well above the acceptable limit of 0.7 (Hair et al., 2006; Fornell & Larcker, 1981) indicating adequate convergent validity.

The discriminant validity of the scales was assessed by comparing the AVE estimates and inter correlations between the constructs in a correlation matrix as presented in Table 2. Since the square root of AVEs of the constructs were greater than their corresponding correlations with other constructs, the scales were considered to have good discriminant validity (Fornell & Larcker, 1981). Thus, the measurement model with seven constructs and 40 items exhibited adequate validity and reliability. The mean values showed that the respondents perceived their workplace safety in chemical companies to be satisfactory indicated by an overall mean value of 3.28 on a scale of 1-5 (Refer Table 6). The respondents rated their psychological capital and emotional intelligence at a moderate level with mean values of 3.04 and 3.19 respectively. While respondents' perceived workplace support was higher (3.12), family support was lower (2.75). The person-job fit had the lowest mean value of 1.93 implying that the respondents perceived very low compatibility with their job. Both rewards and promotion opportunities as well as organizational support was perceived as dismal with lower scores of 2.14 and 2.24 respectively. The respondents reported moderate level of psychological capital indicated by an overall mean value of 3.17. They perceived a fairly good degree of empowering leadership and social capital at workplace represented by mean values of 3.30 and 3.40 respectively. The organizational reputation of the chemical companies was perceived to be good (3.11). The job stress perceived by the respondents was average (2.71) and higher work engagement (3.35).

**Structural Equation Modelling**

The structural equation model built using the measurement model obtained from CFA comprised the seven constructs interrelated as hypothesized in the proposed conceptual framework (See Figure 1). The SEM estimated using maximum likelihood (ML) method was found to have adequate model fit ( $\chi^2 = 2144.09$ ,  $p = .00$ ; GFI = .829; CFI = .902; NFI = .859; IFI = 0.902; RMSEA = 0.055). The assessment of squared multiple correlations ( $R^2$ ) revealed that the structural model explained 19 percent of the variance in perceived workplace safety, 55 percent of the variance in job stress and 74 percent of the variance in employee engagement construct. Based on the notion that a large number of



**Nandhini and T.Frank Sunil Justus**

factors might influence these constructs in real world, the amount of variance explained by the model was considered reasonable. The path coefficients and their p-values indicate the strength and significance of the relationships between the constructs in the conceptual framework. The results revealed that empowering leadership was the strongest predictor of employee perception of workplace safety with a significant positive effect ( $\beta = 0.242$ ,  $p < 0.01$ ). This result is analogous to past research findings on leadership and workplace safety relationship where leadership type was predominantly safety leadership or transformational leadership (Zao et al., 2022; Draghici et al., 2022). Workplace social capital emerged as the second strongest predictor of employee perception of workplace safety with a significant positive effect ( $\beta = 0.194$ ,  $p < 0.01$ ). This study was one of the first to hypothesize and validate the influence of social capital as a whole on workplace safety perceptions. Organizational reputation was also found to have a significant positive effect ( $\beta = 0.119$ ,  $p < 0.03$ ) on employees' perception of workplace safety. This result is concurrent to past research findings on the positive relationship between organization's reputation and employees' safety climate perception in other industries such as manufacturing, healthcare, etc. (Barling and Hutchinson, 2000; Mira et al., 2013). While these three antecedents were significant predictors of employees' workplace safety perception, psychological capital did not have a direct significant effect on the same.

This contradicts the claim by Bergheim et al. (2015) that employees with high psychological capital exhibiting strong ability to adjust and cope with hardships, focus on their work performance including safety involvement, behaviour and management. It can be inferred that employees with high psychological capital need not necessarily have positive perception of workplace safety in chemical companies. However, psychological capital had a significant negative effect ( $\beta = -0.144$ ,  $p < 0.03$ ) on job stress. This result validates the Job-Demand Resources theory and broaden-and-build theory (Bakker and Demerouti, 2008; Fredrickson, 2001) and past research argument that employees with high psychological capital have a more positive outlook, confidence, hope and resilience during challenging situations, hence are less likely to report job stress (Abbas and Raja, 2015). Empowering leadership emerged as the strongest predictor of employees' perceived job stress with a significant negative effect ( $\beta = -0.573$ ,  $p < 0.00$ ). This result validates the Job-Demand Resources theory (Bakker & Demerouti, 2007) and Liu et al's. (2021) claim that empowering leaders are effective social and organizational resource who facilitate healthy leader-employee relationship, giving sub-ordinates more autonomy and vitality, and helping to increase their job satisfaction by relieving job stress and burnout. Empowering leadership also had a significant positive effect on employee engagement ( $\beta = 0.582$ ,  $p < 0.00$ ) which was found to be strongest linkage in the structural model. This result is in sync with the past research findings that empowering leader behaviour where subordinates are given freedom and autonomy enhances their motivation to be more proactive, committed and engaged in their job (Tuckey et al., 2012; Lee et al., 2016). Workplace social capital was found to have a significant negative effect on employees' job stress ( $\beta = -0.294$ ,  $p < 0.048$ ). This result validates the past research on the positive relationship of social capital at workplace and employees' health-related outcomes such as stress, depression and mental health (Poortinga, 2006; Sapp et al., 2010; Boyas et al., 2012; Gao et al., 2014; Firouzbakht et al., 2018).

However, workplace social capital did not have a significant effect on employee engagement which contradicts the past research argument that organizations with strong social capital have more committed and engaged employees (Fujita et al., 2016; Marcus et al., 2016; Meng et al., 2018). It can be inferred that in this study context of chemical companies, the social capital at workplace did not directly influence the employee engagement. On the other hand, organizational reputation had a significant positive effect on employee engagement ( $\beta = 0.112$ ,  $p < 0.031$ ). This result validates the argument by few researchers (Davies et al., 2004; Men, 2012; Shirin and Kleyn, 2017) that corporate reputation affects the way employees perform and behave. Specifically, this study was one of the first to validate the influence of organizational reputation on employee engagement. Finally, employee perception of workplace safety had a significant negative effect on their job stress ( $\beta = -0.072$ ,  $p < 0.035$ ) and positive effect on employee engagement ( $\beta = 0.066$ ,  $p < 0.032$ ). Employees' perceived stress was also found to have a significant negative effect on their level of engagement ( $\beta = -0.365$ ,  $p < 0.00$ ). These results are analogous to past research findings that exposure to risk at workplace increases stress among employees (Berry and Kim, 1988; Lazarus and Folkman, 1984; Ramos et al., 2021). It also validates the Social Exchange theory and norm of reciprocity that employees' perception of organizational support and care for their well-being employees (Eisenberger et al., 2002) in the form of management's commitment



**Nandhini and T.Frank Sunil Justus**

to safety and implementation of safety practices reduces employees' stress and enhances their engagement with their job (Dejoy et al., 2010; Huang et al., 2016). The SEM estimation results showed that 11 out of 13 hypothesized relationships were found to be significant. The summary of regression/path coefficients of all relationships along with hypotheses testing results is presented in Table 7. The SEM path diagram with the standardized regression/path coefficients ( $\beta$ ) of the relationships between the constructs is shown in Figure 3.

**CONCLUSION AND RESEARCH IMPLICATIONS**

In conclusion, addressing employee perceptions of safety in the chemical industry, as revealed in the study conducted in SIPCOT, Tamil Nadu, is essential for fostering a secure work environment and ensuring organizational success. The unique multidimensional scale and conceptual framework developed in this study contribute valuable insights to workplace safety research, offering a new perspective on the interplay of psychological and social factors in this context. The study emphasizes the need for evidence-based strategies, continual assessment of safety protocols, and collaboration between stakeholders to advance safety practices and promote the well-being of employees in the chemical industry. Recognizing the interconnectedness of mental health and safety, and adapting to evolving work arrangements, will be crucial for sustaining a resilient safety framework. Ultimately, prioritizing employee perceptions of safety is not only a legal and ethical obligation but also a strategic imperative for the sustainable growth of the chemical industry. The research implications highlight the significance of understanding and addressing employee perceptions of safety in the chemical industry. The developed multidimensional scale and conceptual framework offer valuable tools for assessing workplace safety in this context, providing a foundation for evidence-based strategies and continuous improvement. The study emphasizes the need for ongoing collaboration between researchers, industry professionals, and regulatory bodies to advance safety practices and ensure the well-being of employees in the chemical industry. The findings also underscore the importance of adapting to changing work arrangements and considering the interconnectedness of mental health and safety in fostering a resilient and adaptive safety framework

**LIMITATIONS AND FUTURE RESEARCH DIRECTIONS**

- Examine the effectiveness of a newly developed multidimensional scale and conceptual framework in assessing workplace safety in the chemical industry over time.
- Investigate the impact of evolving safety technologies and remote work arrangements on safety perceptions and practices to gain insights into the industry's adaptability.
- Longitudinal studies should be conducted to evaluate the sustained impact of evidence-based strategies and analyze the relationship between mental health and safety perceptions for a comprehensive comprehension.
- Enhance insights into safety dynamics through cross-cultural analyses and comparisons in different organizational contexts.
- Emphasize continued collaboration between researchers, industry professionals, and regulatory bodies to refine safety standards and implement best practices in the chemical industry.
- Evaluate the effectiveness of the developed multidimensional scale and conceptual framework for assessing workplace safety in the chemical industry over an extended period.
- Investigate how evolving safety technologies and remote work arrangements influence safety perceptions and practices, shedding light on the industry's adaptability.
- Undertake longitudinal studies to assess the prolonged impact of evidence-based strategies on workplace safety, focusing on the correlation between mental health and safety perceptions.
- Explore safety dynamics through cross-cultural analyses, comparing different organizational contexts to deepen insights into the varying influences on workplace safety.
- Promote continuous collaboration between researchers, industry professionals, and regulatory bodies to refine safety standards and implement best practices in the chemical industry.





## REFERENCES

1. Acakpovi, A., & Dzamikumah, L. (2016). An investigation of health and safety measures in a hydroelectric power plant. *Safety and Health at Work*, 7(4), 331-339.
2. Babu, G. (2020). Boiler explosion in NLC India's thermal power plant injures eight workers. Retrieved from [https://www.business-standard.com/article/current-affairs/boiler-explosion-in-nlc-india-s-thermal-power-plant-injures-eight-workers-120050701424\\_1.html](https://www.business-standard.com/article/current-affairs/boiler-explosion-in-nlc-india-s-thermal-power-plant-injures-eight-workers-120050701424_1.html)
3. Cameron, D. (2021). History of Workplace Health and Safety. Retrieved from <https://staysafeapp.com/blog/2020/08/21/history-workplace-health-and-safety/>
4. Christian, M. S., Bradley, J. C., Wallace, J. C., & Burke, M. J. (2009). Workplace safety: a meta-analysis of the roles of person and situation factors. *Journal of Applied Psychology*, 94(5), 1103.
5. Cohen, A. (1977). Factors in successful occupational safety programs. *Journal of Safety Research*, 9(4), 168-178.
6. Cox, S. J., & Cheyne, A. J. T. (2000). Assessing safety culture in offshore environments. *Safety Science*, 34(1-3), 111-129.
7. Damodaran, K. (2011). Job satisfaction among the employees of neyveli lignite corporation limited. *International Journal of Social and Economic Research*, 1(1), 182-189.
8. Dedobbeleer, N., & Béland, F. (1991). A safety climate measure for construction sites. *Journal of Safety Research*, 22(2), 97-103.
9. DePasquale, J. P., & Geller, E. S. (1999). Critical success factors for behavior-based safety: A study of twenty industry-wide applications. *Journal of Safety Research*, 30(4), 237-249.
10. Griffin, M. A., & Neal, A. (2000). Perceptions of safety at work: a framework for linking safety climate to safety performance, knowledge, and motivation. *Journal of Occupational Health Psychology*, 5(3), 347.
11. Griffiths, D. K. (1985). Safety attitudes of management. *Ergonomics*, 28(1), 61-67.
12. Guadagnoli, E., & Velicer, W. F. (1988). Relation of sample size to the stability of component patterns. *Psychological Bulletin*, 103(2), 265.
13. Hair, J. F., Black, W. C., Babin, B. J., Anderson, R. E. & Tatham, R. L. (2006). *Multivariate data analysis* (6th ed.). Pearson Prentice Hall.
14. Hindu (January 2021). Fire accident at defunct thermal power station. Retrieved from <https://www.thehindu.com/news/cities/Madurai/fire-accident-at-defunct-thermal-power-station/article33481242.ece>
15. Hindu (July, 2020). Six workers killed, 17 injured in boiler blast at thermal power plant in Tamil Nadu's Neyveli. Retrieved from <https://www.thehindu.com/news/national/tamil-nadu/boiler-blast-in-nlcil-in-neyveli/article31960462.ece>
16. Hindu (May, 2014). One killed, six injured in NLC steam pipeline burst. Retrieved from <https://www.thehindu.com/news/one-killed-six-injured-in-nlc-steam-pipeline-burst/article6029253.ece>
17. Hughes, P., & Ferrett, E. D. (2008). *Introduction to health and safety in construction*. Routledge.
18. IHSA Thermal Power Plants Manual. Retrieved from [https://www.ihsa.ca/rtf/health\\_safety\\_manual/pdfs/locations/Power\\_Plants.pdf](https://www.ihsa.ca/rtf/health_safety_manual/pdfs/locations/Power_Plants.pdf)
19. India TV News (April 2021). UP: 13 injured as boiler explodes at thermal power plant in Sonbhadra. Retrieved from <https://www.indiatvnews.com/news/india/sonbhadra-thermal-power-plant-blast-lanco-anpara-thermal-power-plant-695350>
20. Kannagi, S. A. & Mahalingam, S. (2013). A study on perception of non-managerial employees about quality of work life in NLCIL, Neyveli. *International Journal of Scientific Research*, 2(8), 275-276.
21. Kirwan, B. (1998). Human error identification techniques for risk assessment of high risk systems—Part 1: review and evaluation of techniques. *Applied Ergonomics*, 29(3), 157-177.
22. Labodová, A. (2004). Implementing integrated management systems using a risk analysis based approach. *Journal of Cleaner Production*, 12(6), 571-580.
23. Lavrakas, P. J. (2008). *Encyclopedia of Survey Research Methods*. Sage publications.
24. Lee, T. (1998). Assessment of safety culture at a nuclear reprocessing plant. *Work & Stress*, 12(3), 217-237.





**Nandhini and T.Frank Sunil Justus**

25. Maheshwari, V. (2018). A study on job satisfaction among the employees of neyveli lignite corporation limited in Tamil Nadu state, Ph.D. Thesis, Annamalai University, India.<http://shodhganga.inflibnet.ac.in:8080/jspui/handle/10603/257734>
26. Manickavasagam, V. (1997). Measuring Morale of Employees in Neyveli Lignite Corporation. *Indian Journal of Public Administration*, 43(4), 921-932.
27. Mossink, J. C. M., & de Greef, M. (2002). *Inventory of socioeconomic costs of work accidents*. Bilbao: Office for Official Publications of the European Communities.
28. Mythily, J. A. (2019). A study in employees' perception on organisational commitment with special reference to NLC Ltd., Neyveli. *Journal of Xi'an Shiyou University*, 16(9), 335-339.
29. Nahrgang, J. D., Morgeson, F. P., & Hofmann, D. A. (2011). Safety at work: a meta-analytic investigation of the link between job demands, job resources, burnout, engagement, and safety outcomes. *Journal of Applied Psychology*, 96(1), 71.
30. Pandiyan, L. (2020). HRD climate and its effect on job performance in NLCIL. *The International Journal of Analytical and Experimental Modal Analysis*, 12(1), 2020.
31. Percy Bose, B. (2005). A study on employees job satisfaction in Neyveli Lignite Corporation Limited, Neyveli, Ph.D. Thesis, Annamalai University, India. <http://shodhganga.inflibnet.ac.in:8080/jspui/handle/10603/61426>
32. Rathod, R., Gidwani, G. D., & Solanky, P. (2017). Hazard analysis and risk assessment in thermal power plant. *International Journal of Engineering Sciences and Research Technology*, 6(7), 177-185.
33. Rundmo, T. (1994). Associations between safety and contingency measures and occupational accidents on offshore petroleum platforms. *Scandinavian Journal of Work, Environment & Health*, 128-131.
34. Saunders, M., Lewis, P., & Thornhill, A. (2009). *Research methods for business students*. Pearson Education.
35. Shanmugam, A. (2015). A Study on the Job Satisfaction, Job Involvement and Work Ethics of the Engineers of the Neyveli Lignite Corporation Limited. *Asia Pacific Journal of Research*. 1(19), 163-170.
36. Shannon, H. S., Mayr, J., & Haines, T. (1997). Overview of the relationship between organizational and workplace factors and injury rates. *Safety Science*, 26(3), 201-217.
37. Shannon, H. S., Walters, V., Lewchuk, W., Richardson, J., Moran, L. A., Haines, T., & Verma, D. (1996). Workplace organizational correlates of lost-time accident rates in manufacturing. *American Journal of Industrial Medicine*, 29(3), 258-268.
38. Srivastava, S. (2020). Industrial accidents: Time for Neyveli Lignite to take a call. Retrieved from <https://www.downtoearth.org.in/news/pollution/industrial-accidents-time-for-neyveli-lignite-to-take-a-call-72111>
39. Sunil Justus, F., & Sunitha, T. (2019). Employee perception of safety practices at large scale chemical industries in Tuticorin, Tamil Nadu. *CU Global Management Review*, 8(2), 16-27.

**Table 1: List of Selected SIPCOT Industrial Complexes and Chemical Companies**

SIPCOT Industrial Complex	Company Name	Year of Establishment	Approx. Employee Size
Gummidipoondi	SRF Ltd.		600
	Shinsung Petrochemicals Pvt. Ltd.	2009	130
	Xmold Polymers Pvt. Ltd.	1993	60
Cuddalore	Tanfac Industries Ltd.	1972	250
	Chemplast Cuddalore Vinyls Ltd.	2009	300
	Tagros Chemicals	1992	100







**Nandhini and T.Frank Sunil Justus**

	Clariant Chemicals		100
Tuticorin	VV Titanium Pigments	1994	900
	Easternbulk Lime Products Pvt. Ltd.		

**Table 2: Scales adopted to measure Constructs in the Hypothesized Conceptual Framework**

Construct	Scale	Source
Perceived Workplace Safety	10 items derived from popular WSS scales	Hayes et al. (1998); Justus (2015)
Psychological capital	6 items derived from 12-item Psychological Capital scale	Luthans et al. (2007)
Empowering leadership	6 items adopted from Empowering Leadership questionnaire	Arnold et al. (2000)
Workplace social capital	5 items derived from Social Capital at Work scale	Kouvonen et al. (2006)
Organizational reputation	6 items adopted from Reputation and Brand Image scales	Kim and Lennon (2013); Eklöf and Westlund (2002)
Job stress	6 items derived from Perceived Stress scale	Cohen et al. (1983); Mackie et al. (2001)
Employee engagement	8 items inspired by Engagement Index	Civian et al. (2008)

**Table 3: Distribution of Respondents based on SIPCOT Industrial Complex and Chemical Companies**

SIPCOT and Chemical Companies	Number of Respondents	Percent
<b>Gummidipoondi SIPCOT</b>	<b>159</b>	<b>29.8</b>
SRF Ltd.	84	15.7
Shinsung Petrochemicals Pvt. Ltd.	52	9.7
Xmold Polymers Pvt. Ltd.	23	4.3
<b>Cuddalore SIPCOT</b>	<b>255</b>	<b>47.8</b>
Tanfac Industries Ltd.	95	17.8
ChemplastCuddaloreVinyls Ltd.	79	14.8
Tagros Chemicals	48	9.0
Clariant Chemicals	33	6.2
<b>Tuticorin SIPCOT</b>	<b>120</b>	<b>22.5</b>
VV Titanium Pigments	86	16.1
Easternbulk Lime Products Pvt. Ltd.	34	6.4
<b>Total</b>	<b>534</b>	<b>100.0</b>

**Table 4: Demographic Characteristics of the Respondents**

Demographic Characteristics	Number of Respondents	Percent
<b>Age</b>		
25 years & below	135	25.3





**Nandhini and T.Frank Sunil Justus**

	26 to 35 years	230	43.1
	36 to 45 years	112	21.0
	Above 45 years	57	10.7
<b>Education</b>			
	ITI/Diploma	132	24.7
	Graduation or above	402	75.3
<b>Marital Status</b>			
	Single	219	41.0
	Married	315	59.0
	<b>Total</b>	<b>534</b>	<b>100.0</b>

**Table 5: Job Characteristics of the Respondents**

Job Characteristics	Number of Respondents	Percent	
<b>Cadre</b>			
	Management	118	22.1
	Staff	416	77.9
<b>Monthly Income</b>			
	Below Rs. 25000	172	32.2
	Rs. 25000-50000	210	39.3
	Rs. 50001-75000	115	21.5
	Above Rs. 75000	37	6.9
<b>Job Tenure</b>			
	Below 5 years	279	52.2
	5 to 10 years	192	36.0
	Above 10 years	63	11.8
<b>Number of Safety Trainings</b>			
	5 or below	348	65.2
	6 to 10	121	22.7
	Above 10	65	12.2
<b>Industrial Accident Exposure</b>			
	Yes	196	36.7
	No	338	63.3
	<b>Total</b>	<b>534</b>	<b>100.0</b>





**Nandhini and T.Frank Sunil Justus**

**Table 6: Confirmatory Factor Analysis – Validity and Reliability Assessment**

Constructs	Mean	Composite Reliability	SAF	ENG	ST	PC	LDR	WSC	OR
SAF	3.28	0.956	<b>0.886</b>						
ENG	3.35	0.894	0.415	<b>0.765</b>					
ST	2.71	0.917	-0.364	-0.812	<b>0.805</b>				
PC	3.17	0.846	0.267	0.578	-0.58	<b>0.694</b>			
LDR	3.3	0.891	0.369	0.8	-0.78	0.488	<b>0.788</b>		
WSC	3.4	0.856	0.344	0.389	-0.311	0.466	0.395	<b>0.738</b>	
OR	3.11	0.833	0.314	0.557	-0.473	0.453	0.429	0.47	<b>0.676</b>

Note: Diagonal elements in bold are sq root of AVE estimates; non-diagonal elements are correlation coefficients; SAF- Employee perception of workplace safety, ENG- Employee engagement, ST- Job stress, PC- Psychological capital, LDR- Empowering leadership, WSC- Workplace social capital, OR-Organizational reputation

**Table 7: SEM – Path Coefficients of Relationships and Hypotheses Test Results**

Relationships			Unstd. Regression Weights	Std. Regression Weights	p-value	Hypothesis Test Result
LDR	→	SAF	0.257	0.242	0	Validated
SC	→	SAF	0.311	0.194	0	Validated
OR	→	SAF	0.155	0.119	0.03	Validated
PC	→	SAF	-	-	-	Not validated
PC	→	ST	-0.173	-0.144	0.041	Validated
LDR	→	ST	-0.557	-0.573	0	Validated
SC	→	ST	-0.432	-0.294	0.048	Validated
SAF	→	ST	-0.066	-0.072	0.035	Validated
SC	→	ENG	-	-	-	Not validated
SAF	→	ENG	0.05	0.066	0.032	Validated
ST	→	ENG	-0.302	-0.365	0	Validated
OR	→	ENG	0.111	0.112	0.031	Validated
LDR	→	ENG	0.469	0.582	0	Validated

Note: SAF- Employee perception of workplace safety, ENG- Employee engagement, ST- Job stress, PC- Psychological capital, LDR- Empowering leadership, WSC- Workplace social capital, OR-Organizational reputation





**Nandhini and T.Frank Sunil Justus**

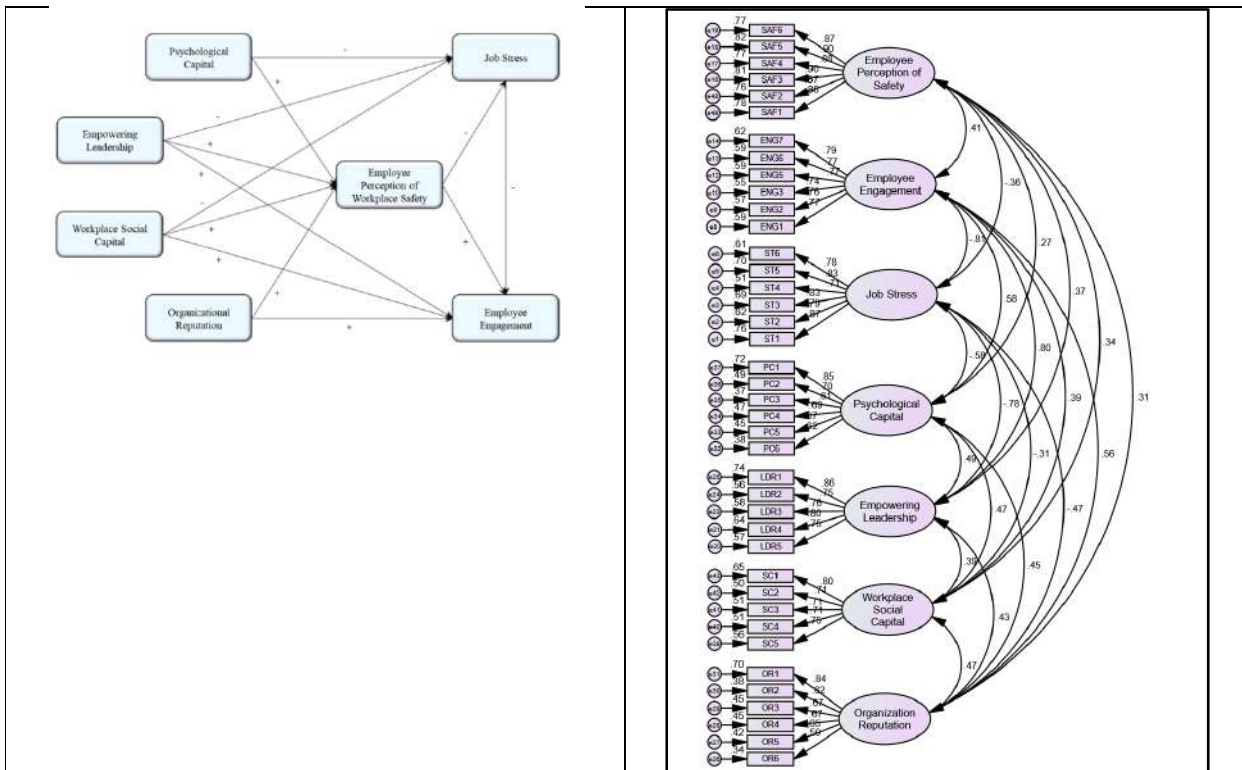


Figure 1: Hypothesized Conceptual Framework

Figure 2: Confirmatory Factor Analysis – Measurement Model

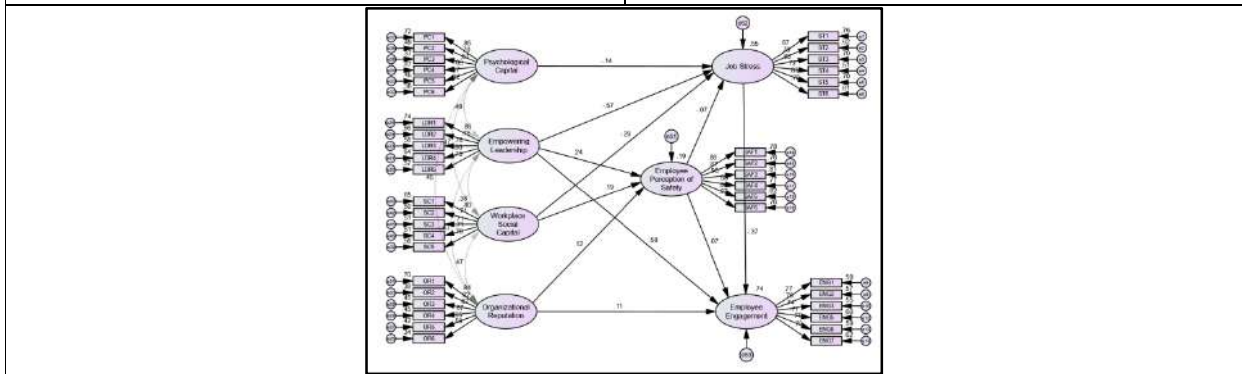


Figure 3: Structural Equation Modelling – Estimation Results





## The Art of Deciphering Emotions: Speech Sentiment Analysis with Deep Learning

Labdhi Gathani<sup>1</sup>, Brinda Davda<sup>1</sup>, Dishita Mashru<sup>2</sup>, Darshana Patel<sup>3\*</sup> and Aditiba Jadeja<sup>2</sup>

<sup>1</sup>Student, Department of Information Technology, Vyavasayi Vidya Pratishthan, Rajkot, (Affiliated to Gujarat Technological University), Gujarat, India.

<sup>2</sup>Assistant Professor, Department of Information Technology, Vyavasayi Vidya Pratishthan, Rajkot, (Affiliated to Gujarat Technological University), Gujarat, India.

<sup>3</sup>Associate Professor, Department of Information Technology, Vyavasayi Vidya Pratishthan, Rajkot, (Affiliated to Gujarat Technological University), Gujarat, India.

Received: 30 Jan 2024

Revised: 06 Feb 2024

Accepted: 27 Apr 2024

### \*Address for Correspondence

#### Darshana Patel

Associate Professor,  
Department of Information Technology,  
Vyavasayi Vidya Pratishthan, Rajkot,  
(Affiliated to Gujarat Technological University),  
Gujarat, India.  
Email: darshana.h.patel@gmail.com



This is an Open Access Journal / article distributed under the terms of the **Creative Commons Attribution License** (CC BY-NC-ND 3.0) which permits unrestricted use, distribution, and reproduction in any medium, provided the original work is properly cited. All rights reserved.

### ABSTRACT

In today's revolutionary world, Deep learning has rapidly emerged as a powerful technology that has potential to save time, provide comfort and enable a wide range of visualization. This research paper proposes a combined approach for speech emotion recognition with sentimental analysis using deep learning. Speech emotion recognition (SER) is the process of identifying human emotions from spoken language. Sentimental analysis (SA) is the process of determining the emotional tone of a piece of text. The proposed system uses a deep learning model that takes both the audio signal and textual content as inputs to predict the emotional state of the speaker. The model is trained using a large dataset of speech samples labelled with corresponding emotions and their textual transcriptions. The combination of speech and textual features allows the model to better capture the nuances of human emotions and improve the overall recognition performance. The proposed approach has potential applications in various fields, such as healthcare, education, and customer service. The ability to accurately recognize human emotions can lead to the development of more effective communication systems that can better understand and respond to the needs of users. In conclusion, the proposed combined approach of speech emotion recognition with sentimental analysis shows promising results in accurately identifying human emotions from real time speech, and then converting that speech into text. Finally sentimental analysis





Labdhi Gathani et al.,

will be carried out considering that text which has the potential to be used in various practical applications such as social media monitoring, marketing, healthcare, etc.

**Keywords:** Speech emotion recognition, Sentimental analysis, Speech to text, Deep learning, Feature Extraction

## INTRODUCTION

In the revolutionary world of today, deep learning is empowering machines to tackle complex problems and make decisions with greater accuracy and speed than ever before. Deep learning is a key technology driving the ongoing revolution in artificial intelligence and machine learning [1]. With its ability to learn from large and complex datasets, deep learning is enabling machines to perform tasks that were previously thought to be the exclusive domain of human intelligence, such as image and speech recognition, natural language processing, and autonomous decision-making. These breakthroughs are transforming many industries, from healthcare and finance to transportation and entertainment, and are likely to have a profound impact on society in the years to come. Deep learning is a type of artificial intelligence (AI) that involves training artificial neural networks to learn from vast amounts of data [1]. Neural networks are computing systems inspired by the structure and function of the human brain, composed of layers of interconnected nodes or "neurons." The term "deep" in deep learning refers to the depth of the neural network, which can have many layers, each one processing a different level of abstraction. By combining multiple layers, deep learning models can learn increasingly complex representations of data and make more accurate predictions. This makes deep learning particularly well-suited for tasks such as image and speech recognition, natural language processing, and even game playing. Deep learning algorithms are designed to analyse and process complex, multi-layered data sets, such as images, videos, and speech, and extract features and patterns to make predictions or decisions. One of the key advantages of deep learning is its ability to learn from unstructured or unlabelled data, which is a significant improvement over traditional machine learning method. Deep learning has enabled breakthroughs in a wide range of fields, from computer vision and speech recognition to natural language processing and robotics. Some examples of deep learning applications include self-driving cars, facial recognition systems, virtual assistants, and medical image analysis.

## APPLICATIONS

The applications of SER are as follows.[1][5][8]

- **Marketing:** SER can be used in marketing to analyse customer feedback and sentiment on social media. This information can be used to improve products and services and create more targeted marketing campaigns.
- **Social media monitoring:** Sentiment analysis is used to monitor social media conversations and detect trends and sentiments related to brands, products, or topics. This information can be used for reputation management, customer service, or market research.
- **Customer feedback analysis:** Sentiment analysis is used to analyse customer feedback and reviews to determine customer satisfaction levels and identify areas for improvement. This information can be used to improve products and services and enhance customer experiences.
- **Market research:** Sentiment analysis is used to analyse customer feedback and social media conversations to identify emerging trends, consumer preferences, and potential product opportunities.
- **Customer service:** SER can be used in customer service to analyse the tone of a customer's voice during a call to determine their emotional state. This information can be used to provide a personalized response and improve the customer experience.
- **Healthcare:** SER can be used in healthcare to detect emotional distress in patients. For example, it can be used to detect signs of depression, anxiety, or stress in a patient's voice during a telemedicine session.





Labdhi Gathani *et al.*,

- **Human-robot interaction:** SER can be used in human-robot interaction to improve the emotional intelligence of robots. For example, it can be used to detect the emotional state of a human interacting with a robot and adjust the robot's response to better match the human's emotional state.

## SPEECH EMOTION RECOGNITION EMOTION RECOGNITION

Emotion recognition is a technology [2] that uses machine learning algorithms to recognize and interpret human emotions. It involves analysing various features, such as facial expressions, voice tone, body language, or physiological signals, to identify emotional states such as happiness, sadness, anger, fear, or surprise. Following are the different methods of emotion recognition.

### Mel-Frequency Cepstral Coefficients (MFCC)

This is a technique used to extract features from speech signals that are relevant to SER. [1] MFCC involves converting the speech signal into a logarithmic frequency scale, dividing it into frames, and calculating the spectrum of each frame.

### Deep Neural Networks (DNNs)

This is a machine learning algorithm used to train models for speech recognition. DNNs involve creating a layered neural network that learns to recognize patterns in the input data.

### Support Vector Machines (SVMs)

This is a machine learning algorithm that can be used to classify speech signals into different emotional states. SVMs involve creating a hyperplane that separates the input data into different categories.

### Hidden Markov Models (HMMs)

This is a statistical model used to recognize speech signals. HMMs involve modelling the probability distribution of speech signals and calculating the most likely sequence of emotional states.

### Convolutional Neural Networks (CNNs)

This is a type of deep neural network that is particularly effective for image and speech recognition.[2] CNNs involve creating a network of layers that extract features from the input data and classify it into different emotional states.

## SPEECH TO TEXT

Speech-to-text technology, also known as speech recognition or voice recognition technology, is a technology that enables a computer or device to recognize and interpret spoken language and convert it into text [3]. This technology uses various algorithms and models to analyse speech and convert it into a written form that can be understood by a computer. Below given are the different approaches.

- **Automatic Speech Recognition (ASR):** This is a technique that involves converting speech into text using machine learning algorithms. ASR involves breaking down the speech signal into individual phonemes and using statistical models to predict the most likely transcription.
- **Deep Neural Networks (DNNs):** This is a machine learning algorithm that is commonly used in ASR systems. DNNs involve creating a layered neural network that learns to recognize patterns in the input speech signal.
- **Hidden Markov Models (HMMs):** This is a statistical model that is often used in ASR systems. HMMs involve modelling the probability distribution of speech signals and calculating the most likely sequence of words.



**Labdhi Gathani et al.,**

- **Language Models:** These are statistical models that are used to predict the probability of different word sequences based on their frequency in each language. Language models are often used in combination with ASR or HMMs to improve the accuracy of speech recognition.
- **Spectral Analysis:** This technique involves analysing the spectral characteristics of the speech signal to identify the phonemes and words being spoken. Spectral analysis involves calculating features such as Mel-Frequency Cepstral Coefficients (MFCCs)[3] or Linear Predictive Coding (LPC) coefficients.

**SENTIMENTAL ANALYSIS**

Sentiment analysis [4], also known as opinion mining, is the process of analysing text data to determine the sentiment or emotion expressed within it. This can involve using machine learning algorithms to classify text as positive, negative, or neutral, or to identify more specific emotions such as joy, anger, or sadness. Sentiment analysis can be applied to various types of text data, such as social media posts, customer reviews, news articles, or survey responses. The goal of sentiment analysis is to extract insights from text data and understand the opinions and attitudes of individuals or groups toward topics, products, brands, or events. There are many different approaches.

- **Lexicon-based approach:** This approach involves using sentiment lexicons, which are lists of words that are associated with positive or negative sentiment. Each word in the lexicon is assigned a sentiment score, and the sentiment score of the text is determined by summing the sentiment scores of the individual words in the text.
- **Machine learning:** Machine learning techniques involve training a model to classify text into positive, negative, or neutral sentiment. The model is trained using a set of labeled data, and the accuracy of the model can be improved by adjusting the parameters of the model or by providing it with more training data.
- **Deep learning:** Deep learning techniques use deep neural networks to identify patterns in text data and to determine sentiment. Deep learning models can be trained on large amounts of data and can achieve high levels of accuracy.
- **Rule-based approach:** Rule-based approaches involve creating a set of rules that define how certain words or phrases are associated with positive or negative sentiment. These rules can be based on the presence of specific words or phrases that are associated with positive or negative sentiment.
- **Hybrid approach:** Hybrid approaches combine multiple techniques, such as lexicon-based and machine learning, to improve the accuracy of sentiment analysis.

**PROPOSED WORKFLOW**

General workflow followed in this paper is preprocessing, feature extraction and classification.

1. **Pre-processing:** The speech signal is first pre-processed to remove noise and other artifacts that may affect the accuracy of emotion recognition.
2. **Feature extraction:** Various features are extracted from the pre-processed speech signal. These features may include pitch, energy, and spectral features, among others.
3. **Classification:** The selected features are used to train a classifier model, which can be based on various machine learning algorithms such as support vector machines (SVM), artificial neural networks (ANN), or decision trees.

**IMPLEMENTATION**

In this paper emotion recognition, speech to text and opinion mining is implemented using python (3.9.6) programming language. This python is very popular tool for deep learning area, In addition to that Jupyter notebook (6.4.3 version) as an environment. here Ryerson Audio-Visual Database of Emotional Speech and Song Dataset (RAVDESS) has been utilized for training the model.

**WORKFLOW****Data Loading RAVDESS**



**Labdhi Gathani et al.,**

The Ryerson Audio-Visual Database of Emotional Speech and Song Dataset (RAVDESS) which contain 1440 files.[4] From that per actor 60 trials they give us. Likewise, there are total 24 actors so by calculating you will get total 1440 data. Which is sufficient for training our model. In the 24 Actors there are 12 female and 12 male actors. They used neutral North American accent for prepare this data. In this they mainly include 8 most important emotion, and this are the emotions calm, happy, sad, angry, fearful, surprise, and disgust.

**Label Emotion**

In this section we are creating an observed emotions array which contain mainly these 8 emotions. Neutral, calm, happy, sad, angry, fearful, disgust, surprised.

**Feature Extraction**

Feature extraction used to extract relevant features from audio signals and emotions. In this mainly audio frequently reflects hidden feeling through tone and pitch. From the given signal information there are mainly three features are extracted. The three features are MFCC, Mel, Chroma [6].

**MFCC**

MFCC stands for Mel Frequency Cepstral Coefficients, a technique to compress spectral content of speech signals into a set of coefficients. These coefficients are often used as features in speech emotion recognition systems to classify the emotional state of a speaker based on their speech signal. MFCCs are effective in capturing the patterns [5]of spectral content associated with different emotions in speech.

**Chroma**

Chroma is a feature extraction technique that captures the tonal content of speech signals in speech emotion recognition. It maps the distribution of energy across the 12 pitch classes of the chromatic scale. Chroma features are used along with [8] other features, such as MFCCs, to improve the accuracy of emotion classification.

**Mel**

Mel refers to Mel-frequency cepstral coefficients, which are commonly used in speech signal processing to represent the spectral features of speech signals. These coefficients are calculated by mapping the frequency spectrum of the speech signal onto a Mel-scale, which is a logarithmic scale that mimics the way human ears perceive sound.

**Split data**

The RAVDESS dataset passed to MLP Classifier. Then we split the dataset in 25:75 ration i.e. testing and training dataset.

**Classifier**

MLP (Multilayer Perceptron) is a type of neural network classifier that can be used in speech emotion recognition to classify speech signals into different emotional categories based on their extracted features, such as [8] Mel-frequency cepstral coefficients. MLP classifiers consist of multiple layers of nodes and can learn complex relationships between input features and emotional categories. They are trained on a labelled dataset of speech samples and can predict the emotional category of new, unlabelled speech samples.

**Evaluation**

When implemented on synthetic database, the following output has been obtained when the speech input provided was “vvp is the best college”. The emotion recognized is happy, and the sentiment analysed was neutral, which is depicted in the following figures. In brief and concise terms, the process of speech to text, speech emotion recognition, and sentimental analysis is a powerful tool for analysing the emotional sentiment expressed in speech signals. By using Mel-frequency cepstral coefficients and MLP classifiers, speech signals can be classified into different emotional categories. Once the speech signal has been converted to text using speech recognition technology, sentimental analysis can be applied to determine the emotional tone of the text data.[9].



**Labdhi Gathani et al.,**

## RESULTS

Also, various classifiers were applied to the RAVDESS Dataset, and after evaluation of the accuracies of those classifiers, it has been observed that the MLP classifier gave the highest accuracy. The accuracy of the proposed system was measured against the emotion recognized, as shown in the figure 10.

## CONCLUSION

Speech Emotion Recognition is about using computers to understand the feelings in someone's speech. It tries to figure out if a person is happy, angry, sad, or frustrated by listening to how they speak, and thus automatic emotion recognition system is still an ongoing subject of research. Thus, it can be widely used in areas like healthcare, social media marketing ad monitoring, etc. It has been observed that the proposed model works effectively when provided with the input from the available dataset, as well as real time voice input, thus converting the same to text efficiently. Considering the emotion recognition, it can be concluded that the proposed system classifies the 'calm' and 'disgust' emotions from the speech with maximum accuracy out of the total eight emotions which has been taken into consideration. Finally, sentiment analysis of the spoken words has been analysed and classified as being positive, negative, or neutral. Thus, overall sentiment analysis for the voice input has been carried out. Furthermore, comparing the accuracies with different classifiers, considering the RAVDESS dataset, it has been observed that MLP classifier provides the highest accuracy in Speech Emotion Recognition. Thus, the model provides an ability to extract valuable information from spoken content can provide a significant advantage for organizations seeking to optimize business operations, improve customer satisfaction, and make data-driven decision.

## REFERENCES

1. Premjeet Singh, Md Sahidullah, Goutam Saha, Modulation spectral features for speech emotion recognition using deep neural networks, *Speech Communication*, Volume 146, 2023, Pages 53-69, ISSN 0167-6393, <https://doi.org/10.1016/j.specom.2022.11.005>.
2. Luis Felipe Parra-Gallego, Juan Rafael Orozco-Arroyave, Classification of emotions and evaluation of customer satisfaction from speech in real world acoustic environments, *Digital Signal Processing*, Volume 120, 2022, 103286, ISSN 1051-2004, <https://doi.org/10.1016/j.dsp.2021.103286>.
3. Jasmeet Kaur, Amit Kumar (2021). Speech Emotion Recognition Using CNN, k-NN, MLP and Random Forest. In: Smys, S., Palanisamy, R., Rocha, Á., Beligiannis, G.N. (eds) *Computer Networks and Inventive Communication Technologies. Lecture Notes on Data Engineering and Communications Technologies*, vol 58. Springer, Singapore. [https://doi.org/10.1007/978-981-15-9647-6\\_39](https://doi.org/10.1007/978-981-15-9647-6_39)
4. Md. Shah Fahad, Ashish Ranjan, Jainath Yadav, Akshay Deepak, A survey of speech emotion recognition in natural environment, *Digital Signal Processing*, Volume 110, 2021, 102951, ISSN 1051-2004, <https://doi.org/10.1016/j.dsp.2020.102951>.
5. Prof. Guruprasad G, Mr. Sarthik Poojary, Ms. Simran Banu, Ms. Azmiya Alam, Mr. Harshith K R "EMOTION RECOGNITION FROM AUDIO USING LIBROSA AND MLP CLASSIFIER" *International Research Journal of Engineering and Technology (IRJET)*, vol8, issue 7, 2021.
6. Meftah, Ali & Qamhan, Mustafa & Alotaibi, Yousef & Zakariah, Mohammed. (2020). Arabic Speech Emotion Recognition Using KNN and KSUEmotions Corpus. *International Journal of Simulation Systems Science & Technology*. 10.5013/IJSSST.a.21.02.21.
7. Navya Damodar, Vani H Y, Anusuya M A. Voice Emotion Recognition using CNN and Decision Tree. *International Journal of Innovative Technology and Exploring Engineering (IJITEE)*, October 2019.
8. Ayush Kumar Shah, Mansi Kattel, Araju Nepal. Chroma Feature Extraction using Fourier Transform. *Chroma\_Feature\_extraction*. January 2019





**Labdhi Gathani et al.,**

9. Linhui Sun, Bo Zou, Sheng Fu, Jia Chen, and Fu Wang. 2019. Speech emotion recognition based on DNN-decision tree SVM model. *Speech Commun.* 115, C (Dec 2019), 29–37. <https://doi.org/10.1016/j.specom.2019.10.004>
10. J. Auguste, D. Charlet, G. Damnati, F. Bechet, and B. Favre, "Can ' we predict self-reported customer satisfaction from interactions?" in *IEEE International Conference on Acoustics, Speech and Signal Processing. IEEE, 2019*, pp. 7385–7389.
11. Awni Hannun, Ann Lee, Qiantong Xu and Ronan Collobert, Sequence to sequence speech recognition with time-depth deperable convolutions, *interspeech 2019*, Sep 2019.
12. Li, Bryan, Dimitrios Dimitriadis, and Andreas Stolcke. "Acoustic and lexical sentiment analysis for customer service calls." *ICASSP 2019-2019 IEEE International Conference on Acoustics, Speech and Signal Processing (ICASSP). IEEE, 2019*.
13. Poria, Soujanya, Navonil Majumder, Rada Mihalcea, and Eduard Hovy. "Emotion recognition in conversation: Research challenges, datasets, and recent advances." *IEEE Access* 7 (2019): 100943-100953.
14. Majumder, Navonil, Soujanya Poria, Devamanyu Hazarika, Rada Mihalcea, Alexander Gelbukh, and Erik Cambria. "Dialoguernn: An attentive rnn for emotion detection in conversations." In *Proceedings of the AAAI conference on artificial intelligence*, vol. 33, no. 01, pp. 6818-6825. 2019.
15. Huang, Chenyang, Amine Trabelsi, and Osmar R. Zaïane. "Ana at semeval-2019 task 3: Contextual emotion detection in conversations through hierarchical lstms and bert." *arXiv preprint arXiv:1904.00132* (2019).
16. Jianfeng Zhao, Xia Mao, Lijiang Chen. *Learning Deep features to Recognise Speech Emotion using Merged Deep CNN. IET Signal Process.*, 2018
17. Monorama Swain, Aurobinda Routray, Prithviraj Kabisatpathy, " Databases, features and classifiers for speech emotion recognition: a review", *I. J. Speech Technology* 2018.
18. Urbano Romeu, Àngel. "Emotion recognition based on the speech, using a Naive Bayes classifier." *Bachelor's thesis, Universitat Politècnica de Catalunya*, 2016.
19. Li, Jinyu, Li Deng, Yifan Gong, and Reinhold Haeb-Umbach. "An overview of noise-robust automatic speech recognition." *IEEE/ACM Transactions on Audio, Speech, and Language Processing* 22, no. 4 (2014): 745-777.
20. Koolagudi, Shashidhar G., and K. Sreenivasa Rao. "Emotion recognition from speech: a review." *International journal of speech technology* 15 (2012): 99-117.

**Table 1: Related work for Speech emotion recognition**

Title	Methods
Modulation Spectral feature for SER Using DNN [1]	Dataset:(EmoDB) & (RAVDESS) Feature Extraction: CQT-MSF and MFSCfeatures Classification: two different machine learning algorithm (1) convolutional neural network with fully connected layer for emotion classification (termed henceforth as DNN). (2) Convolutional layers to extract emotion embeddings and SVM to classify embeddings into emotion classes (termed as DNN-SVM).
SER using Neural Network and MLP Classifier[3]	Dataset: RAVDESS Feature Extraction:MFCC,MEL , Chroma , Tonnetz Classification: Neural Network and Multi-Layered Perceptron classifier.
Voice Emotion Recognition using CNN and Decision Tree [7]	Dataset: (Customized Kannada Dataset) & (RAVDESS) Feature Extraction: MFCC Classification: CNN
Emotion recognition from speech: a review [20]	Dataset: RAVDESS Feature Extraction: MFCC,Mel, chroma, Tonnetz Classification: MLP classifier
Arabic Speech Emotion Recognition Using KNN and KSUEmotionsCorpus [6]	Dataset:KSUEmotions corpus Feature Extraction: zero-crossing rate, short – term energy, MFCC's and delta features



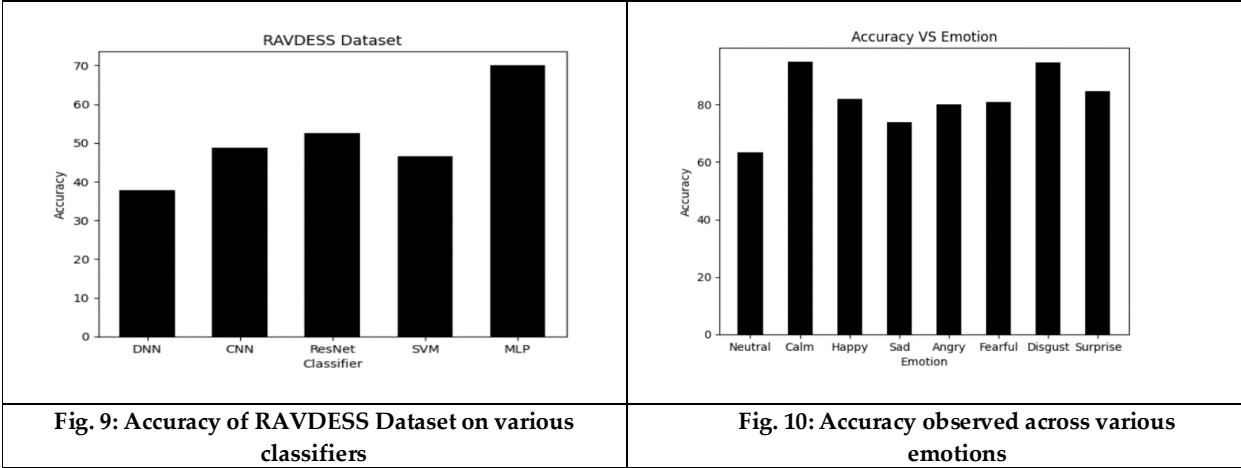


Classification: KNN / SVM	
<b>Fig 1: Speech Emotion Recognition</b>	<b>Fig 2: Speech to Text</b>
<b>Fig 3: Sentimental Analysis</b>	<b>Fig 4: Proposed work</b>
	<div style="border: 1px solid black; padding: 5px; width: fit-content; margin: auto;">vvp is the best College</div>
<b>Fig 5: Workflow</b>	<b>Fig 6: Voice Input to the proposed system</b>
<div style="border: 1px solid black; padding: 5px; width: fit-content; margin: auto;"> <pre> Overall sentiment dictionary is : {'neg': 0.0, 'neu': 1.0, 'pos': 0.0, 'compound': 0.0} sentence was rated as 0.0 % Negative sentence was rated as 100.0 % Neutral sentence was rated as 0.0 % Positive Sentence Overall Rated As Neutral                     </pre> </div>	<div style="border: 1px solid black; padding: 5px; width: fit-content; margin: auto;"> <span>😊 happy</span>  </div>
<b>Fig 7: Emotion Recognized for the Input</b>	<b>Fig. 8: Sentiment Analysis for the voice input</b>





**Labdhi Gathani et al.,**





## Nanapush: Embodiment of Native Wisdom and True Mentorship in the Select Novels of Louise Erdrich

Vinoth.M<sup>1\*</sup>, Aruldoss.L<sup>2</sup> and K.V.S. Nivetha Priya<sup>3</sup>

<sup>1</sup>Assistant Professor, Department of Humanities and Languages, Sona College of Technology, Salem, (Affiliated to Anna University, Chennai), Tamil Nadu, India.

<sup>2</sup>Assistant Professor, Department of English, K. Ramakrishnan College of Technology, Trichy, (Affiliated to Anna University, Chennai), Tamil Nadu, India.

<sup>3</sup>Assistant Professor of English, The Central Law College, Salem, (Affiliated to The Tamil Nadu Dr. Ambedkar Law University, Chennai,) Tamil Nadu, India.

Received: 22 Jan 2024

Revised: 09 Mar 2024

Accepted: 15 May 2024

### \*Address for Correspondence

**Vinoth.M**

Assistant Professor,  
Department of Humanities and Languages,  
Sona College of Technology, Salem,  
(Affiliated to Anna University, Chennai),  
Tamil Nadu, India.

Email: vforvinoth32@gmail.com



This is an Open Access Journal / article distributed under the terms of the **Creative Commons Attribution License** (CC BY-NC-ND 3.0) which permits unrestricted use, distribution, and reproduction in any medium, provided the original work is properly cited. All rights reserved.

### ABSTRACT

The objective of this paper is to explore the concept of mentorship as depicted in select novels by Louise Erdrich. Erdrich is a highly regarded author known for her novels, poetry, and children's books that center on Native American settings and characters. Her work has received numerous accolades, including the National Book Critics Circle Award for fiction for her debut novel *Love Medicine* and the Pulitzer Prize for fiction in 2021 for her recent novel *The Night Watchman*. *Love Medicine*, a collection of stories spanning from 1934 to 1984, revolves around three Chippewa families – the Kashpaws, the Lamartine/Nanapushes, and the Morriseys. Erdrich's later novels, such as *The Beet Queen*, *Tracks*, *The Bingo Palace*, and *Tales of Burning Love*, delve into the lives of the same family members in the fictional town of Argus, North Dakota. The terms "mentor" and "mentorship" have gained popularity in popular culture. According to the American Psychological Association (APA), a mentor is an experienced individual who can assist in the career development and skill-building of a mentee. In this novel, Nanapush, an elder member of the tribal community, emerges as a mentor who guides his mentees, Eli Kashpaw and Nector Kashpaw, in acquiring cultural values, lifestyle, and hunting skills. The novel also highlights the challenges faced by Nanapush as a mentor and Eli and Nector as mentees.

**Keywords:** American Indians, Native wisdom, mentor & mentee, Tribal community, cultural values





## INTRODUCTION

Relationships play a significant role in every individual's life, whether it be within a family, society, or cultural group. One particular type of relationship, known as mentorship, holds immense value as it provides meaning, inspiration, and support in our personal growth. Mentorship is a life-altering connection that brings about positive transformations in various dimensions of our lives, encompassing the personal, social, cultural, and psychological aspects. Throughout literature and history, numerous examples showcase the art of mentoring, often undertaken by experienced mentors, typically elder individuals, who possess a genuine desire to assist and enhance the skills of their mentees. This research paper aims to unravel the depiction and significance of mentorship reflected in the select novels of Louise Erdrich. Louise Erdrich, a highly acclaimed American-Indian author, has made significant contributions to the literary world through her novels, poems, and children's books. Her writings intricately portray the lives, characters, and settings of Native Americans. Renowned for her captivating storytelling, Erdrich has gained widespread recognition and a large readership. Her literary prowess has been acknowledged with numerous prestigious awards, including the National Book Critics Circle Award for Fiction for her debut novel, *Love Medicine*. More recently, Erdrich's novel *The Night Watchman* was honored with the esteemed Pulitzer Prize for Fiction in 2021. *Love Medicine*, a compelling collection of interconnected stories, spans the years between 1934 and 1984, delving into the lives of three Chippewa families - the Kashpaws, the Lamartine/Nanapushes, and the Morriseys. Erdrich's subsequent novels, such as *The Beet Queen*, *Tracks*, *The Bingo Palace*, and *Tales of Burning Love*, continue to explore the lives of these same family members within the fictional town of Argus, North Dakota. Through her vivid storytelling and rich characterization, Erdrich paints a vivid and immersive portrait of the complexities and experiences of Native American life. The terms 'Mentor' and 'Mentorship' have gained significant popularity in contemporary pop culture. Exploring the etymology of the word mentor reveals its Greek origin, derived from the words for "mind" or "spirit." This conveys a sense of purposefulness and personal agency. According to Wiktionary, the term has multiple etymological references. One reference traces its roots to the Sanskrit word 'mantr(a),' meaning advisor or counselor, while another reference links it to the Latin word 'monitor,' which signifies one who admonishes. The term 'mentor' has a rich and esteemed historical background. In Homer's epic poem *Odyssey*, a character named Mentor plays a significant role. When Odysseus, the King of Ithaca, embarks on his journey to join forces with Menelaus in the Trojan War, he entrusts the care of his household to Mentor.

Mentor assumes the role of overseer and teacher to Odysseus' son, Telemachus. Following the conclusion of the war, Odysseus undergoes a ten-year wandering before finally returning home. Meanwhile, Telemachus, now grown but filled with confusion, uncertainty, and hopelessness, faces the relentless pursuit of his mother Penelope by ambitious and unscrupulous suitors. In a remarkable turn, Athena, the Goddess associated with war, handicraft, and wisdom, assumes the guise of Mentor and becomes a guiding figure for the perplexed Telemachus. She counsels him and instills in him the courage to stand against his mother's suitors. Additionally, she aids him in his quest to search for his father. Through her wise counsel, Athena prepares the young Telemachus to succeed his father and become a virtuous and just individual. Thus, over time, the term 'mentor' has evolved to encompass the meaning of a wise person, teacher, counselor, and advisor. Mentoring is a highly meaningful form of human development wherein an experienced and senior individual dedicates their energy, time, and expertise to inspire and enhance the growth and abilities of another person. Numerous definitions of the term 'mentor' can be found across various disciplines. According to the American Psychological Association (APA), a mentor is an individual possessing expertise who can aid in the career development and skill enhancement of a mentee. In diverse fields, countless individuals have greatly benefited from mentoring relationships. The mentor figure holds a significant place in literature and is often portrayed as an archetype. Examples of such mentors include Virgil in *The Divine Comedy*, Gandalf in *Lord of the Rings*, and Dumbledore in *Harry Potter*. In Louise Erdrich's novels, Nanapush, an elder member of the tribal community, emerges as a mentor figure. He assists his mentee, Eli Kashpaw, in acquiring essential cultural and social values, lifestyle knowledge, and hunting skills. This research paper also sheds light on the challenges faced by both Nanapush and Eli Kashpaw throughout the course of the novel. While the concept of mentoring may not be explicitly recognized within indigenous communities, a thorough examination of these communities reveals the





Vinoth et al.,

presence of intergenerational teaching values and the sharing of knowledge and experiences, which can be considered forms of mentorship. The practice of mentoring is deeply rooted in the cultural traditions of many indigenous communities, historically serving as a means to nurture and educate their children and youth. The mentor takes the initiative in establishing the mentoring relationship, selecting the right individual to be mentored based on their own reasons and judgment. The second quality lies in the hierarchical nature of the mentor-mentee relationship, setting it apart from a typical friendship. This hierarchy is characterized by an inequality of knowledge, skills, and experience between the mentor and the mentee. In his work *Nicomachean Ethics*, Aristotle provides a framework for understanding friendship. He defines friendship as a relationship between equals who are united by a shared purpose. However, Aristotle also acknowledges another type of friendship that emerges between an elder and a younger individual. He explains that when the love and respect within this relationship are proportionate to the merit of each party, a sense of equality arises, which is considered a defining characteristic of friendship. Consequently, in a mentoring relationship, the mentor assumes the role of the elder with greater age and superior experience, while the mentee willingly submits to the mentor's authority and guidance. Scholars worldwide have extensively studied and praised the female characters depicted in the works of Louise Erdrich. However, this research paper aims to shed light on the male characters in the novel *Tracks*, *Love Medicine*, *The Bingo Palace* and explore the transformative mentor-mentee relationship that develops between them. In these novels, Nanapush naturally selects Eli Kashpaw as his mentee. Nanapush introduces Eli as a young man who may not possess the highest levels of industry or education. Recognizing Eli's desire to learn the art of hunting, he seeks the guidance of the experienced tribal elder, Nanapush, who possesses extensive knowledge of native culture and hunting techniques. Nanapush himself acknowledges this suitability for mentoring when he states in his narration,

"I guided the last buffalo hunt. I saw the last bear shot. I trapped the last beaver with a pelt of more than two years' growth...I axed the last birch that was older than I..." (2)

In the early days, Native Americans held the belief that mastering the art of hunting was a pivotal rite of passage from boyhood to manhood. It was widely believed that until a man could prove his hunting skills and provide sustenance for his family, he had not yet reached the status of a fully realized man. In this context, Nanapush assumes the role of mentor to Eli, teaching him the traditional methods of hunting, including the use of bow and arrow, spears, snares, and traps. Additionally, Nanapush guides Eli in venturing out on hunts for both large game such as deer, moose, and buffalo, as well as small game like rabbit, beaver, and muskrat.

"Eli chopped wood, pitched hay, harvested potatoes or cranberry bark. He wanted to be a hunter, though like me, and asked to partner that winter before the sickness...I showed Eli how to hunt and trap from such an early stage that I think he lived too much in the company of trees and winds" (40)

According to Vigen Guroian, the act of establishing a mentoring relationship is defined by the mentor's identification of the mentee, which is a crucial aspect of the process [2]. The mentor must fully dedicate themselves to facilitating the development of essential skills that are not solely private or personal, but rather vital for the continuity of a particular practice or way of life. In the case of Nanapush and Eli, Nanapush explains his choice of Eli as his mentee by highlighting the shrewd-mindedness shared by both Eli and his younger brother, Nector Kashpaw (40). Unlike his brother, Eli lacks the ability to assimilate into white civilization. One day, while tracking a wounded doe during a hunting expedition, Eli unexpectedly encounters Fleur. His intense passion for her drives him to seek guidance from Nanapush once again, this time on how to win her love. At first, Nanapush advises Eli to distance himself from Fleur Pillager. However, Eli expresses his desire for guidance on how to win her affection rather than heeding the warning. Taking pity on Eli, Nanapush shares his own experiences of love and how he endeavored to please his wives in the past. He also recounts the unique gifts he bestowed upon his wives and offers a few of them to Eli. Intrigued, Eli expresses his curiosity about the origins of these gifts and the stories associated with them. Nanapush proceeds to engage in a lengthy conversation with Eli, narrating his interconnected stories without any discernible conclusion. Nanapush said,







Vinoth et al.,

“Talk is an old man’s last vice. I opened my mouth and wore out the boy’s ears, but that is not my fault. I shouldn’t have been caused to live so long, shown so much of death, had to squeeze so many stories in the corners of my brain. They’re all attached, and once I start there is no end to telling because they’re hooked from one side to the other, mouth to tail” (46)

It is essential for a mentee to attentively and patiently listen to the mentor's words, as their patience will eventually yield rewards. The concept of "listen before speaking" is deeply ingrained in the practices of numerous Native American tribes. In the case of Eli Kashpaw, his ability to listen to his mentor enables him to gain mastery over various skills and navigate challenging situations. Nanapush further emphasizes the importance of communication in his own life, stating that his ability to express himself kept him alive during a difficult period of sickness. Nanapush advises Eli regarding his relationship with Fleur, using the analogy, "...it's like you're a log in a stream. Along comes this bear. She jumps on. Don't let her dig in her claws" (46). Equipped with his mentor's advice, Eli approaches Fleur, armed with both his newfound skills and gifts. The wisdom imparted by Nanapush ultimately assists Eli in winning Fleur's love. Nanapush recognizes that Eli is utilizing his guidance to keep Fleur off balance, ensuring a dynamic and evolving connection between them. Driven by jealousy, Eli is persuaded by Marie to engage in a physical relationship with Sophie. As a consequence, Fleur disregards Eli and is unwilling to accept him. In a state of confusion, Eli seeks solace and guidance from Nanapush, visiting his mentor's house with an offering. He hopes that Nanapush will assist him in navigating his relationship with Fleur. Eli expresses his remorse for what has transpired, feeling as though he has been enchanted. However, Nanapush warns him that Fleur will not be easily convinced by excuses. Eli remains in Nanapush's cabin for six days, consuming all of Nanapush's food. On the seventh day, Nanapush provides Eli with a gun and instructs him to go hunting. As Nanapush goes to check his own traps, he discovers that they are empty, leaving him perplexed about how to sustain himself until the end of the prolonged winter.

“In my fist I had a lump of charcoal, with which I blackened my face. I placed my otter bag upon my chest, my rattle near. I began to sing slowly, calling on my helpers, until words came from my mouth but were not mine, until the rattle started, the song sang itself, and there, in the deep bright drifts, I saw the tracks of Eli’s snowshoes clearly” (101)

Nanapush smears his face with charcoal and assumes a prone position to engage in prayer. He possesses the ability to interpret nature with the same proficiency he applies to reading books. Through this connection, he can envision Eli's footprints in the snow and intuitively perceive his emotions. Nanapush comprehends that Eli is aimlessly wandering without sustenance. As Nanapush commences his prayer, his voice rouses Eli, conveying favorable weather conditions and the proximity of an ideal hunting ground for moose. Guided by Nanapush's spiritual influence, Eli arrives at a location where he can discern the tracks of several moose and proceeds to follow them. Meanwhile, Nanapush continues his melodic prayer, while Eli meticulously prepares for the final stage of his moose hunt. Through a telekinetic connection, Nanapush reminds and cautions Eli about the importance of not startling the moose during the hunt, as the adrenaline released in the animal's bloodstream would negatively affect the quality of the meat. Following Nanapush's teachings, Eli shoots the moose when it rests after feeding, recalling that every living creature on Earth has a designated place in the cycle of life. The Native American understanding is that animals were created to sustain their people, and they express gratitude for the gifts provided by nature. In contrast, European hunting practices often lack this level of consideration. Once Eli successfully kills the moose, he carefully opens its belly and consumes a small portion of the liver for nourishment, reserving the majority of it for Nector. As an offering to nature, he buries another piece of the liver in the snow, symbolizing respect for both the natural world and the animal itself, which enables his family's survival. Eli proceeds to skillfully butcher the carcass and places the meat on his body. He then makes his way back to Nanapush's cabin at a deliberate pace, mindful of avoiding excessive exertion that could lead to sweating and potentially result in hypothermia.

“There is a temptation, when it is terribly cold and the burden is heavy, to quicken pace to warm the blood...I know it well...Without opening my eyes ... I took the drum from beneath



**Vinoth et al.,**

my bed and beat out footsteps for Eli to hear and follow. Each time he speeded I slowed him. I strengthened the rhythm whenever he faltered beneath the weight he bore. In that way he, returned, and when I could hear the echo of his panting breath, I went outside to help him, still in my song." (104)

Through the utilization of traditional tribal wisdom, Nanapush is able to bridge the distance between himself and Eli. He skillfully beats his drum in a rhythmic manner, enabling Eli to synchronize his footsteps with the sound. As a result, Eli safely arrives at the cabin. With great care, Nanapush removes the frozen meat from Eli's body, which has conformed to his shape. He consumes the portion of moose liver that Eli had reserved for him. Nanapush then wraps Eli in a blanket and situates him near the stove to provide warmth. Continuing his nurturing efforts, Nanapush prepares the heart and kidneys of the moose and feeds them to Eli. Feeling a stronger attraction towards Fleur than before, Eli confides in Nanapush and seeks his guidance on how to regain her love. Nanapush questioned Eli's sanity but provided him with a strategy to rekindle Fleur Pillagers' affections by evoking her pity. Eli must humble himself in order to regain Fleur's love and trust. After a restful sleep, he awakens feeling rejuvenated. Despite the exertion, Eli ventures out twice to bring the remaining meat of the moose to Fleur, but succumbs to the weight of his burden, collapsing under its load. Fleur responds with insults, yet Eli recalls the advice imparted by his mentor, recognizing this as a valuable opportunity to mend their relationship. Mentorship is widely acknowledged as a potent tool for personal, social, and psychological growth. It is a dynamic process that often transcends its initial purpose, evolving into a genuine friendship where both parties provide mutual support. Within ethnic communities, mentorship plays a crucial role in preserving and nurturing traditional values. In this novel, Nanapush serves as a mentor to Eli Kashpaw, guiding him through the trials and tribulations of life. Nanapush offers not only emotional and mental support to Eli but also imparts the wisdom necessary for him to become a well-rounded individual, a responsible husband, and a skilled hunter. Nanapush's expertise and knowledge elevate him to a distinguished position as a mentor. Through his facilitation, he leaves a profound impact on Eli's determination to carry forward the cultural values to future generations.

## REFERENCES

1. Ambrosetti, Angelina and John Dekkers. "The Interconnectedness of the Roles of Mentors and Mentees in Pre-Service Teacher Education Mentoring Relationships." *Australian Journal of Teacher Education*, vol. 35, Oct. 2010, pp. 42-55. Accessed 2 Oct. 2021
2. Erdrich, Louise. *Tracks*. Harper Perennial, 2006.
3. Erdrich Louise. *Love Medicine*. Harper Perennial, 2006.
4. Kurup, Seema. *Understanding Louise Erdrich*. Univ of South Carolina Press, 2015.
5. Guroian, Vigen. "Literature and the Real Meaning of Mentorship." 2008. Accessed. 28 September 2021
6. Jemc, Jac. "Tracks Characters: Nanapush." LitCharts. LitCharts LLC, 20 Apr 2018. Accessed. 6 Aug 2021.
7. Jenn. "Writing a Worthy Mentor Archetype Character - Herded Words." *herded words*, www.herdedwords.com/mentor-archetype/. Accessed 9 Oct. 2021. Accessed 9 Oct. 2021.
8. Ragins, Belle Rose and Kathy E. Kram. "The Roots and Meaning of Mentoring." *Crown Sage Publishing*, vol. 10, no. 2, 2007, pp. 3-15. Accessed 2021.





## Computational Analysis of *Psidium guajava* L. Bioactive Compounds: Molecular Docking and Evaluation of Anti-Bacterial Properties

Vino Udappusamy<sup>1</sup>, V. Sankaravel<sup>2</sup>, A. Jayaprakash<sup>3</sup>, G. Shalini<sup>4</sup> and T. Rajan<sup>5\*</sup>

<sup>1</sup>Ph.D Research Scholar, Department of Biochemistry, PSG College of Arts and Science, (Affiliated to Bharathiar University) Coimbatore, Tamil Nadu, India.

<sup>2</sup>Assistant Professor, Department of Botany, PSG College of Arts and Science, (Affiliated to Bharathiar University) Coimbatore, Tamil Nadu, India.

<sup>3</sup>Ph.D Research Scholar, Department of Microbiology, PSG College of Arts and Science, (Affiliated to Bharathiar University) Coimbatore, Tamil Nadu, India.

<sup>4</sup>Assistant Professor, Department of Biotechnology, PSGR Krishnammal College for women, (Affiliated to Bharathiar University) Coimbatore, Tamil Nadu, India.

<sup>5</sup>Assistant Professor, Department of Biochemistry, PSG College of Arts and Science, (Affiliated to Bharathiar University) Coimbatore, Tamil Nadu, India.

Received: 22 Jan 2024

Revised: 09 Feb 2024

Accepted: 27 Apr 2024

### \*Address for Correspondence

**T. Rajan**

Assistant Professor,  
Department of Biochemistry,  
PSG College of Arts and Science,  
(Affiliated to Bharathiar University)  
Coimbatore, Tamil Nadu, India.  
Email: rajan@psgcas.ac.in



This is an Open Access Journal / article distributed under the terms of the **Creative Commons Attribution License** (CC BY-NC-ND 3.0) which permits unrestricted use, distribution, and reproduction in any medium, provided the original work is properly cited. All rights reserved.

### ABSTRACT

This study aimed to explore the medicinal potential of *Psidium guajava* L. (guava) leaf extracts by investigating their antibacterial, antioxidant, and Insilco properties. Specifically, the research focused on identifying potential bioactive compounds within the extracts, assessing their interactions with target proteins through molecular docking studies, and predicting their biological activities using the PASS Prediction tool. Additionally, the study employed the Lipinski rule of 5 to evaluate drug-likeness and predict ADME toxicity. Dried extracts from *Psidium guajava* L. leaves were subjected to analysis for antibacterial and antioxidant properties. Molecular docking studies were conducted to investigate the interaction of identified compounds with target proteins. The PASS Prediction tool was utilized for predicting biological activities, while the Lipinski rule of 5 guided the assessment of drug-likeness and ADME toxicity. Among the compounds analyzed, 7-epi-trans-Sesquisabinene hydrate demonstrated a noteworthy binding energy of -6.68 kcal/mol. This compound formed hydrogen bonds with the PRO residue, exhibiting a bond length of 2.0 Å. The findings of this study highlight the potential therapeutic

73982



**Vino Udappusamy et al.,**

benefits of *Psidium guajava* L. leaf extracts, particularly the compound 7-epi-trans-Sesquisabinene hydrate, which exhibited promising antibacterial properties. The molecular docking results suggest significant interactions with the target protein, emphasizing the compound's potential efficacy. Further investigations are recommended to explore the stability of protein-compound interactions through continued docking studies, paving the way for potential drug development from *Psidium guajava* L. leaf bioactive compounds.

**Keywords:** *Psidium guajava* L, Molecular Docking, Antibacterial Properties, Bioactive Compounds, Medicinal Plants.

## INTRODUCTION

Nature is always a golden sign to show the prominent phenomena of coexistence. Natural products from plants, animals, and minerals are the basis for treating human diseases. Medicinal plants are presently in demand and their acceptance is increasing progressively. Undoubtedly, plants play an important role by providing essential services in ecosystems. Without plants, humans and other living organisms cannot live in the way living should be. Anyway, herbals especially medicinal herbs have constantly acted as an overall indicator of ecosystem health[1]. Medicinal plants have undoubtedly been considered by human beings since ancient times. It can be said that before history and since the early humans recognized and exploited the plants around them for use as fuel, clothing, shelter, and food; they became aware of their properties. Guava, or *Psidium guajava* L., is a medicinal plant that belongs to the Myrtaceae family. *Psidium guajava* is a well-known traditional remedy that is used in several indigenous medical systems. It is widely spread throughout India. The *Psidium guajava* tree's leaves and bark have a long history of healing applications that are still in use today[2]. Despite being a native of Central America, it is now widely developed, diffused, and its organic products help millions of people throughout the world's jungles improve their diets[3]. Computer-aided drug discovery methods have developed as more advanced technologies that may be used to search for drugs made from phytochemicals found in several therapeutic plants.

For technological and pharmaceutical research, computational prediction models play a crucial role in directing approach choice[4]. Additionally, they have been utilized to predict pharmacokinetic, pharmacological, and toxicological performance in silico. Currently, molecular docking is a successful and economical method for creating and evaluating medications [5,6]. This method produces information on how drugs interact with receptors that may be used to forecast how drug candidates will bind to their target proteins. Additionally, this method makes systemic research easier by non-covalently introducing a molecule into a macromolecule's binding site, resulting in precise binding at each ligand's active sites. In this regard, the GC-MS approach was employed in the current investigation to find and identify the phytochemical components present in the medicinal plant[7]. So, more research is needed to determine the potential therapeutic efficacy and possible mechanisms of action of *Psidium guajava* fruit. In response to all of the above, the current research was designed to (1) evaluate the in-vitro antibacterial activity of the *Psidium guajava* leaf methanolic extract (2) identify the potential bioactive components present in the active extract through the GC/MS analysis; and (3) apply an in-silico analysis for the most abundant compounds against the target proteins involved in the life cycle of bacteria.

## MATERIALS AND METHODS

### Collection of plant material and process of Soxhlet extraction

*Psidium guajava* leaves were collected around Palani, Dindigul District, Sattaparai hill Station, Tamil Nadu. Collected leaves were thoroughly washed with distilled water. Further, the leaves were shadow dried for five days to remove moisture content and finely grained using mortar and pestle, and stored in polythene bags for later use. To obtain



**Vino Udappusamy et al.,**

the plant extract using the Soxhlet apparatus method, Methanol solvents were chosen for their polarity index. The extract was filtered using Whatman No. 1 filter paper, and the extracts were then concentrated using a rotating vacuum evaporator, which were then stored at 4 °C for future purposes (Fig 1).

**GC–MS analysis of *Psidium guajava* leaf**

GC–MS analysis was performed on the Perkin Elmer system, using a silica capillary column. Helium (99.9%) was used as the carrier gas, with a constant flow of 1 mL/min and an injection volume of 0.5 EI. An isothermal program was used at 110 °C for 2 min, in 10 °C/min increments to 200 °C, then from 5 °C/min to 280 °C and 9 min at 280 °C. Mass spectra were taken at 70 eV, with a scanning interval of 0.5<sup>[8]</sup>.

**Bacterial strains**

Three gram-positive bacteria were utilized to assess the antibacterial activities of *Staphylococcus aureus* and *Salmonella typhi*, *Bacillus subtilis*. And two gram-negative bacteria, *Proteus vulgaris* and *Escherichia coli*. The bacteria were initially collected at the Department of Microbiology, PSG College of Arts & Science, Coimbatore, Tamil Nadu, India.

**Inoculum preparation**

The bacteria were pre cultivated in a rotatory shaker at 37°C in a nutrient broth and centrifuged for 5 minutes in 10,000 rpm. The pellet was suspended in dual water with a cell density of 660 nm

**Antimicrobial properties**

The disc diffusion method was employed to examine *Psidium guajava leaf extract* Different concentrations. (100-400 µg/ml) were achieved by reconstituting the Guava peels. The test microorganisms have been planted into the appropriate medium by utilizing the spread plate technique. 10ul with nutrient broth growing cultures for 24 hours. Following solidification on test organism seed plates, filtered paper discs (5 mm in diameter) soaked with the extract were inserted. chloramphenicol (10 g/ml) was the positive control while *Psidium guajava peel extract* (100 µg/ml) was the negative control. The antimicrobial testing plates were incubated at 37 degrees Fahrenheit for 24 hours. The sizes of the inhibitory zones were measured in millimeters (mm)<sup>[9]</sup>.

**PDB**

The Protein Data Bank (PDB) is crystallographic database for the three-dimensional auxiliary information of enormous natural atoms, for example, proteins and nucleic acids. The PDB is administered by a living being known as the Overall Protein Information Bank. The PDB is a distinct advantage in the zone of basic science, for example, basic genomics. Most major logical diaries, a portion of the subsidizing organizations, are presently expecting researchers to present their structure information to the Protein Information Bank. Huge numbers of the other database are utilized the protein structures are stored in PDB. For instance, SCOP and CATH group protein structures, while PDB entirety gives a realistic diagram of PDB passages utilizing data from different sources as well. The protein was looked in the question box. The protein was chosen from the outcome. The 3D structures of the protein were gotten. The related basic data was taken for the docking investigation. The 3D structure was recovered to PDB position.

**PubChem**

PubChem is a data base which contains synthetic atoms. This information base was kept up by national place for biotechnology data (NCBI). It very well may be gotten to for nothing through a web UI. Right now, the compound structures are effortlessly downloaded through FTP. It comprises of three powerfully developing essential database. This information base incorporates a substance structure, name parts, compound equation, sub-atomic weight, XLogP, and hydrogen security contributor and acceptor check. It contains its own online atom bolster that permits the import and fare of all regular substance record organizations to look for the structures and pieces. The structures of the regular mixes are chosen from the plants were from the PubChem database. The structures were spared as 3D SDF records.





Vino Udappusamy et al.,

**Drugability**

Lipinski rule of 5 helps in distinguishing between drug like and non-drug like molecules. It predicts high probability of success or failure due to drug likeness for molecules complying with 2 or more of the following rules

- Molecular mass less than 500 Dalton
- High lipophilicity (expressed as LogP less than 5)
- Less than 5 hydrogen bond donors
- Less than 10 hydrogen bond acceptors
- Molar refractivity should be between 40-130

**Molecular docking study**

MGL tools with AutoGrid4 and AutoDock4[10,11] were used to set up and perform blind docking calculations between the Ligands and Protein. Crystallized 3-dimensional structure was obtained from the Protein Data Bank (PDB). Receptor (protein) and ligand (complex) files were prepared using Auto Dock Tools. The protein was enclosed in a box with number of grid points in x y z directions, 50 50 50 and a grid spacing of 0.375 Å. The center of the grid set to -6.516, 30.278 and -1.951 Å. Lamarckian genetic algorithms, as implemented in Auto Dock, were employed to perform docking calculations. All other parameters were default settings. For each of the docking cases, the lowest energy docked conformation, according to the Auto Dock scoring function and number hydrogen bonds was selected as the binding mode. The output from Auto Dock was rendered with PyMOL[12].

**PyMol**

PYMOL is an open-source, user-sponsored, and a molecular visualization system. It is a private software company dedicated to creating a useful tool that will become a universally accessible to scientific and educational communities. The PyMOL can produce a high quality of 3D images with a small molecules and biological macromolecules, such as proteins, PyMOL is one of a few open-source visualization tools which is used in a structural biology. Proportion of the software's name refers to the fact that it extends, and is extensible by the python programming language[13].

**RESULT AND DISCUSSION****Phytochemical screening**

The phytochemical screening of the methanolic extract of *Psidium guajava* was conducted to identify and characterize its bioactive compounds. Various chemical tests were employed to detect the presence of secondary metabolites such as alkaloids, flavonoids, tannins, saponins, glycosides, and phenols. The results indicated the rich phytochemical composition of *Psidium guajava*, suggesting its potential medicinal value. These bioactive compounds are known for their diverse pharmacological properties, including antioxidant, antimicrobial, and anti-inflammatory activities. The findings contribute valuable insights into the therapeutic potential of *Psidium guajava* and support its traditional use in herbal medicine<sup>[14]</sup>.

**GC-MS analysis**

The GC-MS spectrum of *Psidium guajava* leaf methanolic extract is given in Fig. 2 and the presence of various bioactive compounds was determined. The compounds detected in extract were ranked as 5-Hydroxy methyl furfural>Thymine> Catechol>7-epi-trans-Sesquisabinene hydrate and Benzoic acid >3,4,5-trimethoxy-2-nitro- according to their presence rates. Among the active ingredients, 5-Hydroxy methyl furfural has a high rate as the major component. Catechol and 5-Hydroxy methyl furfural have anti-cancer, anti-oxidant, anti-inflammatory, anti-tumor, anti-microbial, diuretic properties and is frequently used in vaccine formulations.

**Antimicrobial activity**

We studied the antibacterial activity of *Psidium guajava* leaf extract against *Staphylococcus aureus* and *Bacillus subtilis* in this study, and found that gram positive bacteria were greatly suppressed. However, just one bacterium strain,



**Vino Udappusamy et al.,**

*Proteus vulgaris*, showed the lowest activity. Gram positive bacteria are more resistant to the antibacterial effect of *Psidium guajava* peels than Gram negative bacteria. The size of the zone of inhibition is generally equivalent to the difference of antimicrobial activity present in the sample or product, with a greater zone of inhibition indicating a stronger antibacterial. chloramphenicol was utilized as a reference for comparison. The antibacterial activity of the *Psidium guajava* leaf extract against *Staphylococcus aureus* and *Bacillus subtilis* were considerably different [15]. Results as seen in Table.2 and Figure .3 Previous researchers found that guava leaf extracts have stronger antibacterial activity against gram positive bacteria and moderate efficacy against gram negative bacteria [16].

**PDB (Protein Data Bank)**

The 3D structure of protein (Penicillin binding protein 3) was retrieved from the protein data bank (PDB) and it was viewed using the visualization tool PyMOL.

**PUBCHEM**

The compounds are isolated along with their molecular weight, molecular formula and PubChemCID, where PubChem is the database for accessing small molecules.

**Molecular docking analysis for antibacterial activity:**

To understand the mechanism of antimicrobial activity of the extract, molecular docking of active ingredients in extract with bacterial proteins was performed. The major components, which are intensely found in an extract, have an important role in the formation of biological activity compared to the minor components. Computer docking techniques play an important role in drug design and elucidation of mechanism. The flexible docking programs, Auto Dock and molecular operating environment (MOE) help in predicting favorable protein–ligand complex structures with a reasonable accuracy and speed. These docking programs, when used prior to experimental screening, can be considered as powerful computational filters to reduce labor and cost needed for the development of effective medicinal compounds. When used after experimental screening, they can help in better understanding of bioactivity mechanisms. Molecular models were built to discuss the binding modes by docking using Auto Dock program for the interactions of 5-Hydroxy methyl furfural, Thymine, Catechol, 7-epi-trans-Sesquisabinene hydrate and Benzoic acid, 3,4,5-trimethoxy-2-nitro- with multiple Penicillin binding Protein. The structure of each drug was drawn and subjected to energy optimization. These were then imported to PDB file for docking purpose. Final analysis of docking results with the compounds is tabulated. All the bindings are visualized by using the Structure Visualization tool PyMOL viewer, the interaction between the chemical compounds and target protein was observed, and further were shown in the figure. Computer docking techniques play an important role in drug design and elucidation of mechanism. The flexible docking programs, Auto Dock, and molecular operating environment (MOE) help in predicting favorable protein–ligand complex structures with a reasonable accuracy and speed.

These docking programs, when used prior to experimental screening, can be considered as powerful computational filters to reduce labor and cost needed for the development of effective medicinal compounds. When used after experimental screening, they can help in better understanding of bioactivity mechanisms. Molecular models were built to discuss the binding modes by docking using Auto Dock program for the interactions of 5-Hydroxymethyl furfural, Thymine, Catechol, 7-epi-trans-Sesquisabinene hydrate and Benzoic acid, 3,4,5-trimethoxy-2-nitro- with multiple Penicillin binding Protein. The structure of each drug was drawn and subjected to energy optimization. These were then imported to PDB file for docking purpose. Final analysis of docking results with the compounds are tabulated. All the bindings are visualized by using the Structure Visualization tool PyMOLviewer, the interaction between the chemical compounds and target protein was observed, and further was shown in the figure. The compound 7-epi-trans-Sesquisabinene hydrate had Binding energy of -6.68 Kcal/mol and formed hydrogen bonds with the residue PRO showing the bond length of 2.0 Å. The compound Benzoic acid, 3,4,5-trimethoxy-2-nitro- had Binding energy of -5.55 Kcal/mol and formed hydrogen bonds with the residue MET and ASN showing the bond length of 3.0 and 2.1 Å. The compound Thymine had Binding energy of -4.91 Kcal/mol and formed hydrogen bonds with the residue ASN, HIS and MET showing the bond length of 2.2, 1.7, 2.1 Å. The compound 5-Hydroxy methyl furfural had Binding energy of -4.93 Kcal/mol and formed hydrogen bonds with the residue GLY showing the bond



**Vino Udappusamy et al.,**

length of 2.0 and 1.9 Å. The compound 5-Hydroxymethyl furfural with binding energy of -4.63 Kcal/mol and formed hydrogen bonds with the residue GLY and ASN showing the bond length of 2.0, 1.9 and 2.0 Å. Further, the interactions of plant compounds with the target would compare to the presently available drug molecule, to study its potency. As well as the simulation studies would provide an insight about the stability of protein-compound complex. The plant compounds indicating collaboration with the protein are arranged with the Binding energy. The plant compounds and the information of their hydrogen bond, collaborating deposits and individual bond lengths were organized independently (Table 6). Utilizing PyMOL tool, the cooperation between the synthetic mixes and target protein are visualized and the communication of the compound was appeared in the figure 3. Carbon atoms of the ligands are shown in green. Oxygen atoms are red, nitrogen atoms are dark blue and Sulphur atoms are yellow. Hydrogen bonds are debuted in yellow dotted lines.

**CONCLUSION**

*Psidium guajava* leaf extract has shown biological properties that can be used to treat various diseases. Based on the current investigation, *Psidium guajava* leaf methanolic extract significantly inhibits the growth of several bacterial strains. Data from in-silico experiments showed that 7,4,5-trimethoxy-2-nitro, Benzoic acid, and 5-hydroxy methyl furfural all had molecular interactions. The penicillin binding protein (PBP) sites are more specifically targeted by A. They could be substances with strong antibacterial properties. This can also be used to shed light on how possible antibacterial medications for strains of bacteria that are resistant to them work.

**ACKNOWLEDGEMENTS**

The authors are grateful to acknowledge the Department of Biochemistry, PSG College of Arts & Science College, Coimbatore, India for providing necessary facilities during the study. This research did not receive any specific grant from funding agencies in the public, commercial, or not-for-profit sectors. The author declares no conflict of interest associated with this publication and there has been no significant financial support for this work that could have influenced its outcome.

**REFERENCE**

1. Singh, H. B. (2003). *Herbal medicine of Manipur: A colour Encyclopaedia*. Daya Books.
2. Firenzuoli F, Gori L. Herbal medicine today: clinical and research issues. *Evid Based Complement Alternat Med*. 2007;4(Suppl 1):37-40. doi: 10.1093/ecam/nem096.
3. Nair, R., & CHANDA, S. (2007). Antibacterial activities of some medicinal plants of the western region of India. *Turkish Journal of Biology*, 31(4), 231-236.
4. Loza-Mejía, M. A., Salazar, J. R. & Sánchez-Tejeda, J. F. In Silico studies on compounds derived from Calceolaria: Phenylethanoid glycosides as potential multitarget inhibitors for the development of pesticides. *Biomolecules* 8, 121 (2018).
5. Bharathi, A. et al. In silico molecular docking and in vitro antidiabetic studies of dihydropyrimido [4, 5-a] acridin-2-amines. *BioMed Res. Int*. 2014, 10 (2014).
6. Lee, K. & Kim, D. In-silico molecular binding prediction for human drug targets using deep neural multi-task learning. *Genes* 10, 906 (2019).
7. Trott, O. & Olson, A. J. AutoDock Vina: Improving the speed and accuracy of docking with a new scoring function, efficient optimization, and multithreading. *J. Comput. Chem*. 31, 455–461 (2010).
8. Praveen, K. P., Kumaravel, S. & Lalitha, C. Screening of antioxidant activity, total phenolics and GC-MS study of *Vitex negundo*. *Afr. J. Biochem. Res*. 4, 191–195 (2010).







**Vino Udappusamy et al.,**

9. Obada, D. O., Ossen, S. A., Sina, H., Salami, K. A., Oyedeji, A. N., Dodoo-Arhin, D., ... & Dauda, E. T. (2021). Fabrication of novel kaolin-reinforced hydroxyapatite scaffolds with robust compressive strengths for bone regeneration. *Applied Clay Science*, 215, 106298.
10. G. M. Morris, R. Huey, and A. J. Olson, UNIT using AutoDock for ligand-receptor docking, no. SUPPL. 24. 2008.
11. Vel, V. S., & Arunprasath, A. (2021). Evaluation of Fungal Activity Through In Silico Analysis of Medicinal Plants Against *Exophiala jeikei*. *Advanced Journal of Graduate Research*, 9(1), 81-95.
12. W.L. DeLano. "The PyMOL molecular graphics system". <http://www.Pymol.org>, 2002.
13. Schrodinger, L. L. C. The PyMOL molecular graphics system. Version 1, 0 (2010).
14. Venkatachalam, R. N., Singh, K., & Marar, T. (2012). Phytochemical screening in vitro antioxidant activity of *Psidium guajava*. *Free Radicals and Antioxidants*, 2(1), 31-36.
15. Mulat, M., Pandita, A., & Khan, F. (2019). Medicinal plant compounds for combating the multi-drug resistant pathogenic bacteria: a review. *Current pharmaceutical biotechnology*, 20(3), 183-196.
16. Maharaj, A., Naidoo, Y., Dewir, Y. H., & Rihan, H. (2022). Phytochemical Screening, and Antibacterial and Antioxidant Activities of *Mangifera indica* L. Leaves. *Horticulturae*, 8(10), 909.

**Table 1: Preliminary Phytochemical screening**

Phytochemicals	Methanol
<b>Alkaloids</b>	
Mayers test	+
Dragendroff's test	-
Wagners test	-
<b>Amino acids</b>	
Ninhydrin test	+
<b>Carbohydrates</b>	
Fehling's test	+
Barfoed's test	-
Molisch's test	+
<b>Protein</b>	
Biuret test	+
Millons test	-
<b>Flavonoids</b>	
Alkaline test	-
Ferric chloride test	+
Lead Acetate	+
<b>Cardiac Glycosides</b>	
Keller-killiani test	+
Legal's test	+
<b>Steroids</b>	
Salkowski test	+
Liebermann-Burchard reaction	+
<b>Saponification test</b>	
Foam test	-
<b>Tannins</b>	
Ferric chloride test	+
<b>Thiols</b>	
	+
<b>Anthraquinones</b>	
	+
<b>Volatile oils</b>	
	+





Vino Udappusamy et al.,

Table 2: Antibacterial activity of *Psidium guajava* leaf extract

Human pathogenic bacteria	Zone of inhibition in (mm)				Chloramphenicol 10 µg/ml
	10	20	30	40	
<i>Staphylococcus aureus</i>	16	19	17	20	12
<i>Proteus vulgaris</i>	7	8	14	17	14
<i>E-coli</i>	5	6	7	11	12
<i>Bacillus subtilis</i>	12	13	16	17	21

Table 3: Structure of Protein

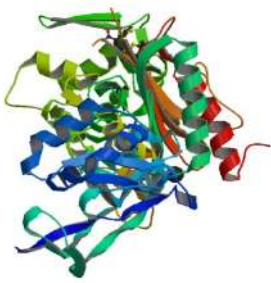
ORGANISM NAME	PROTEIN NAME & ID	STRUCTURE	RESIDUES COUNT
<i>Pseudomonas aeruginosa</i>	Penicillin binding protein 3(PBP3) ID-6UN3		573

Table 4: Compound identification in Pubchem

PLANT NAME	PUBCHEM COMPOUND	PUBCHEM CID	MOLECULAR FORMULA	MOLECULAR WEIGHT
<i>Psidium guajava</i>	5-Hydroxy methyl furfural	237332	<a href="#">C<sub>6</sub>H<sub>6</sub>O<sub>3</sub></a>	126.11 g/mol
	Thymine	1135	C <sub>5</sub> H <sub>6</sub> N <sub>2</sub> O <sub>2</sub>	126.11 g/mol
	Catechol	289	C <sub>6</sub> H <sub>6</sub> O <sub>2</sub>	110.11 g/mol
	7-epi-trans-Sesquisabinene hydrate	100930863	C <sub>15</sub> H <sub>26</sub> O	222.37 g/mol
	Benzoic acid, 3,4,5- trimethoxy-2-nitro-	97116	C <sub>10</sub> H <sub>11</sub> NO <sub>7</sub>	257.2 g/mol





**Vino Udappusamy et al.,**

**Table 5: Lipinski rule of five in selected active compounds**

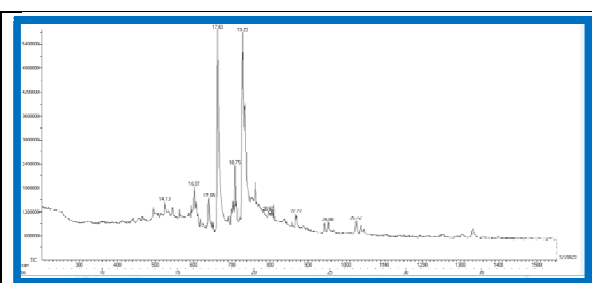
LIPINSKI RULE OF FIVE	Molecular mass less than 500 Dalton	High lipophilicity (expressed as LogP less than 5)	Less than 5 hydrogen bond donors	Less than 10 hydrogen bond acceptors	Molar refractivity should be between 40-130
237332	126	0.58	1	3	48.88
1135	126	0.27	2	4	40.43
289	110	1.09	2	2	49.35
100930863	222	3.91	1	1	68.77
97116	257	1.31	1	7	59.71

**Table 6: Interaction of compounds with PENICILLIN BINDING PROTEIN 3 (6UN3)**

S.No	Name of the ligand / PubChem ID	Binding energy	Interacting amino acids	Bond length	No of H-Bonds
1.	5-Hydroxy methyl furfural	-4.63	GLY	2.0	3
				1.9	
			ASN	2.0	
2.	Thymine	-4.91	ASN	2.2	3
			HIS	1.7	
			MET	2.1	
3.	Catechol	-4.13	MET	1.9	2
				1.9	
4.	7-epi-trans-Sesquisabinene hydrate	-6.68	PRO	2.0	1
5.	Benzoic acid, 3,4,5-trimethoxy-2-nitro-	-5.55	MET	3.0	5
			ASN	2.1	
				2.2	
			GLY	2.7	
	1.8				



**Figure 1 Graphical representation of work flow**



**Figure 2. GC-MS Chromatogram of *Psidium guajava* leaf**







## Neutrosophic Fuzzy Soft Matrix Application on Living Standard of Human Life

J.Boobalan<sup>1\*</sup> and Afrine.N.S.Shiny<sup>2</sup>

<sup>1</sup>Assistant Professor, Department of Mathematics, Annamalai University, Annamalai Nagar, Chidambaram, Tamil Nadu, India.

<sup>2</sup>Research Scholar, Department of Mathematics, Annamalai University, Annamalai Nagar, Chidambaram, Tamil Nadu, India.

Received: 19 Oct 2023

Revised: 12 Apr 2024

Accepted: 20 May 2024

### \*Address for Correspondence

**J.Boobalan**

Assistant Professor,

Department of Mathematics,

Annamalai University, Annamalai Nagar,

Chidambaram, Tamil Nadu, India.

Email: jboobalan@hotmail.com



This is an Open Access Journal / article distributed under the terms of the **Creative Commons Attribution License** (CC BY-NC-ND 3.0) which permits unrestricted use, distribution, and reproduction in any medium, provided the original work is properly cited. All rights reserved.

### ABSTRACT

This manuscript deals with the concept of Neutrosophic Fuzzy Soft Matrix theory in real life. The concept on composition of Neutrosophic Fuzzy Soft Matrix is applied to solve the problems especially the living standard in human life.

**Keywords and phrases:** Neutrosophic Fuzzy Soft Set, Neutrosophic Fuzzy Soft Matrix, Composition and Complement of Neutrosophic Fuzzy Soft matrices.

**2020 AMS Classification:** 03E72, 15B15, 15B99

## INTRODUCTION

The concept of fuzzy set was first introduced by Zadeh [29] in various fields of research with the examples of applications. Sanchez [19, 20] fuzzy relation is used in many applications of medical diagnosis. Using the concept of fuzzy sets (FS) as the base many researchers have extended it to have many branches as the intuitionistic fuzzy set (IFS) given by Atanassov [1, 2] and interval fuzzy set found by Turksen [25]. It was Molodtsov [13] who initiated the concept of soft set theory. The concept of fuzzy soft set is used in many applications to solve the problems in medical science, social science, etc. On generalizing the concept of fuzzy soft set Maji et al. [9, 10] have developed the concept of IFSS. Babitha and John [3] had generalized the IFSS and studied its applications. In broad area of Science and Engineering, matrices play an important role. Thomason [24] has introduced the concept of fuzzy matrix under max-min products in the interval [0,1]. Later, Kim and Roush [8] have progressed the concept of fuzzy matrices by





**Boobalan and Afrine.N.S.Shiny**

comparing the theory of Boolean matrices. The theory of fuzzy soft matrix was extended and its applications have studied by Borah et al. [12]. Murugadas and Lalitha [14] obtained the concept on decomposition on IFMs using an operator. Then, as generalization Bhowmik and Pal [4, 5] have given the concept of IFMs and IVIFS. On elaborating the concept of IFMs. Im et al. [27] have studied the determinant of the square IFMs. Many researchers had applied the concept of IFMs and incorporated several applications in many areas of research [7, 17, 18]. Smarandache [21, 22] initiated the idea of neutrosophic set (NS), first, by defining the term indeterminacy. Then Pabitra Kumar Maji [16] has developed Neutrosophic soft set (NSS) by comparing the theory of neutrosophic set (NS) and Fuzzy Soft Set (FSS). Sumathi and Arrokiarani [23] have studied the concept of Neutrosophic soft matrices with some new operators. Murugadas et al. [15] had studied and developed the decomposition concept of neutrosophic fuzzy matrices (NFMs). Broumi and Florentin Samrandache [6] had studied the concept of (INS) and introduced the concept of INSS with some definitions and operations. As a development the (NS) has been elaborated and studied by many researchers, in many fields, and found many applications in medical diagnosis useful in decision making [28, 11].

In this manuscript, we extend the concept of intuitionistic fuzzy soft matrix as a support mechanism applicable in human life [26] and the concept of neutrosophic fuzzy soft matrix for application in human life.

**Preliminaries**

In this section, some basic notions, required for the sections of the article, are discussed.

**Definition.1 [11]** A IFS  $A$  in  $X$  is an object of the form  $A = \{x, \mu_A(x), \vartheta_A(x) | x \in X\}$  where, the functions of  $\mu_A: X \rightarrow [0,1]$  and  $\vartheta_A: X \rightarrow [0,1]$  define the degree of membership and degree of non-membership elements of the set  $X$  to the subset  $A$  and for every  $x \in X, 0 \leq \mu_A(x) + \vartheta_A(x) \leq 1$ . Whereas, the  $\pi_A(x) = 1 - \mu_A(x) - \vartheta_A(x)$  which is called as hesitation margin of  $x$  in  $A$ .

**Definition.2 [11]** Let the  $X$  be the universe discourse of the set  $E$  and  $E$  be the set of parameters, the collection of all intuitionistic fuzzy subsets of  $X$  is denoted as  $P(X)$ . Let the  $U \subseteq E$ , then, the pair  $(F_U, E)$  is said to be an intuitionistic fuzzy soft set over the set  $X$ , where, the  $F_U$  is a mapping from  $F_U: E \rightarrow P(X)$ .

**Definition.3 [15]** Let the  $X$  be the universe of discourse, the neutrosophic fuzzy set  $U$  on the universe of  $X$  is defined as  $U = \{x, T_U(x), I_U(x), F_U(x) | x \in X\}$ , where the characteristic functions of  $T, I, F: X \rightarrow [0,1]$  and  $0 \leq T + I + F \leq 3$ ;  $T, I, F$  are the neutrosophic components. If an element  $u$  in the neutrosophic set  $U$ , it will be written as  $u = \{u^T, u^I, u^F\}$ , whereas which denotes the degree of membership, indeterminacy and non- membership respectively.

**Definition.4 [11]** Let the set  $X$  be the universe of discourse and the  $E$  be the set of parameters. Let the  $P(X)$  indicates collections of all neutrosophic subsets of  $X$ . Let the  $A \subseteq E$ . Then the pair  $(F_A, E)$  is said to be the neutrosophic soft set over  $X$ , where the  $F_A$  is a mapping from  $F_A: E \rightarrow P(X)$ .

**Example.5** Assume that  $A = (u_1, u_2, u_3)$  be the set of three types of clothes and prize of a cloth material is low ( $v_1$ ), moderate ( $v_2$ ), high ( $v_3$ ) be the set of parameters. Then

$$F_A(v_1) = (u_1, .4, .3, .8), (u_2, .2, .5, .3), (u_3, .9, .5, .4)$$

$$F_A(v_2) = (u_1, .3, .2, .1), (u_2, .9, .3, .1), (u_3, .6, .2, .1)$$

$$F_A(v_3) = (u_1, .5, .4, .8), (u_2, .4, .2, .3), (u_3, .4, .6, .2)$$





**Boobalan and Afrine.N.S.Shiny**

We represent it in a tabular form as follows for (NSS) Neutrosophic Soft Set

A	$v_1$	$v_2$	$v_3$
$u_1$	(.4, .3, .8)	(.3, .2, .1)	(.5, .4, .8)
$u_2$	(.2, .5, .3)	(.9, .3, .1)	(.4, .2, .3)
$u_3$	(.9, .5, .4)	(.6, .2, .1)	(.4, .6, .2)

**Definition.6 [15]** A neutrosophic matrix is a matrix in which all entries originate in neutrosophic set. That is of the form  $U = [u_{ij}] = [u_{ij}^T, u_{ij}^I, u_{ij}^F]$ .

**Definition.7 [11]** Let the neutrosophic fuzzy soft matrices corresponding to neutrosophic fuzzy soft set  $(F_A, E)$  over  $X$  be  $U = [u_{ij}] \in N_m$ ,  $[u_{ij}] = [u_{ij}^T(x), u_{ij}^I(x), u_{ij}^F(x)]$  for every  $(i = 1, 2, \dots, m)$  and  $(j = 1, 2, \dots, n)$

**Definition.8 [15]** Let  $V \in N_m$ , where,  $U = [u_{ij}] = [u_{ij}^T, u_{ij}^I, u_{ij}^F]$  and  $V = [v_{ij}] = [v_{ij}^T, v_{ij}^I, v_{ij}^F]$ . Then the operations of  $\oplus, \otimes$  of  $U, V$  is defined as  
 $U \oplus V = \{\max(u_{ij}^T, v_{ij}^T), \max(u_{ij}^I, v_{ij}^I), \min(u_{ij}^F, v_{ij}^F)\}$  and  
 $U \otimes V = \{\min(u_{ij}^T, v_{ij}^T), \min(u_{ij}^I, v_{ij}^I), \max(u_{ij}^F, v_{ij}^F)\}$

**Definition.9 [14]** Let  $U \in N_m$  and  $V \in N_m$  then the composition of  $U$  and  $V$  is defined as  $U \circ V = \sum_{k=1}^n u_{ik}^T \wedge v_{kj}^T, \sum_{k=1}^n u_{ik}^I \wedge v_{kj}^I, \prod_{k=1}^n u_{ik}^F \vee v_{kj}^F$ . The composition of  $U \circ V$  will be defined if and only if the no. of columns of  $U$  is similar to the no. of rows of  $V$ .

**Definition.10 [23]** Let the  $U, V \in N_{mn}$  such that  $U = [u_{ij}] = [u_{ij}^T, u_{ij}^I, u_{ij}^F]$  and  $V = [v_{ij}] = [v_{ij}^T, v_{ij}^I, v_{ij}^F]$ . Then, there are two cases

Case (i) If  $U \leq V$ , then  $u_{ij}^T \leq v_{ij}^T, u_{ij}^I \leq v_{ij}^I, u_{ij}^F \geq v_{ij}^F$ .

Case (ii) If  $U \geq V$ , then  $u_{ij}^T \geq v_{ij}^T, u_{ij}^I \geq v_{ij}^I, u_{ij}^F \leq v_{ij}^F$ .

**Neutrosophic Fuzzy soft set in Living Standard**

**Definition.11** If the  $U$  is a neutrosophic fuzzy matrix, its complement will denoted  $U^C$  and it is defined as  $U = [u_{ij}] = [u_{ij}^T, u_{ij}^I, u_{ij}^F]$  then  $U^C = [u_{ij}]^C = [u_{ij}^F, u_{ij}^I, u_{ij}^T]$ .

For comparing to the Sanchez’s concept of living standard, we take two matrices  $U_a$  and  $U_b$  as a knowledge of living standard of a Neutrosophic soft set  $(Q_a, K)$  and its complement as  $(Q_a, K)^C$  over the set of basic needs of the status

In the same process, we take two matrices  $V_a$  and  $V_b$  as knowledge of living standard of a Neutrosophic Fuzzy soft set  $(Q_b, H)$  and its complement as  $(Q_b, H)^C$  respectively over the set of basic needs of the places.

Whereas,





**Boobalan and Afrine.N.S.Shiny**

H- represents the set of basic needs of the status

K- represents the set of status of the people those who work in places

L- represents the set of places

Then, we get two matrices  $W_a$  and  $W_b$  on using our definition of composition of two neutrosophic fuzzy matrices as

$$W_a = V_a \circ U_a \text{ and } W_b = V_b \circ U_b$$

Therefore, we find the truth value, indeterminacy value and falsity value of the matrices  $W_a$  and  $W_b$ .

**ALGORITHM**

**Step1:** Input the neutrosophic soft set  $(Q_a, K)$  and find its complement  $(Q_a, K)^c$  Also, find the corresponding matrices  $U_a$  and  $U_b$ .

**Step2:** Input the neutrosophic soft set  $(Q_b, H)$  and find its complement  $(Q_b, H)^c$  Also, find the corresponding matrices  $V_a$  and  $V_b$ .

**Step3:** Now, Find  $W_a = V_a \circ U_a$  and  $W_b = V_b \circ U_b$ .

**Step 4:** Find the membership value, indeterminacy value and non-membership value of the matrices  $W_a$  and  $W_b$ .

**Step5:** Compare the Truth value, Indeterminacy value and Falsity value of  $W_a$  and  $W_b$  individually.

**CASE STUDY**

Assume any three places namely  $l_1, l_2, l_3$  as the educational institution, hospital and industry which require the basic needs such as food, health care, clothing and communication. Suppose the possible status of the people is categorized as educated and uneducated,

Let the  $h_1, h_2, h_3, h_4$  represent the basic needs of food, health care, clothing and communication respectively and  $k_1$  and  $k_2$  represent the status of the people who work in the places, with the basic needs as educated and uneducated

Let the  $H = (h_1, h_2, h_3, h_4)$  and  $K = (k_1, k_2)$  be the parameter set representing the basic needs and status respectively. Also,  $L = (l_1, l_2, l_3)$  be the set of places.

Let  $(Q_a, K)$  be an Neutrosophic soft sets over H where,  $Q_a$  is a mapping from  $k_1$  onto  $Q_a(H)$  that is  $Q_a: k_a \rightarrow Q_a(H)$  gives an appropriate description of Neutrosophic fuzzy soft living standard of the three status and their basic need  $(Q_a, K) = Q_a(k_1), Q_a(k_2)$

$$Q_a(k_1) = \{(h_1, 0.47, 0.50, 0.66), (h_2, 0.85, 0.95, 0.99), (h_3, 0.98, 0.95, 0.69), (h_4, 0.89, 0.88, 0.05)\}$$

$$Q_a(k_2) = \{(h_1, 0.54, 0.60, 0.75), (h_2, 0.75, 0.88, 0.89), (h_3, 0.65, 0.50, 0.35), (h_4, 0.95, 0.89, 0.08)\}$$

Now,

$$(Q_a, K)^c = Q_a(k_1)^c, Q_a(k_2)^c, Q_a(k_3)^c$$

$$Q_a(k_1)^c = \{(h_1, 0.66, 0.50, 0.47), (h_2, 0.99, 0.95, 0.85), (h_3, 0.69, 0.95, 0.98), (h_4, 0.05, 0.88, 0.89)\}$$

$$Q_a(k_2)^c = \{(h_1, 0.75, 0.60, 0.54), (h_2, 0.89, 0.88, 0.75),$$







**Boobalan and Afrine.N.S.Shiny**

$$(h_3, 0.35, 0.50, 0.65), (h_4, 0.08, 0.89, 0.95)\}$$

The above set represents the complement of the neutrosophic fuzzy soft set  $(Q_a, K)$ . Now, we will represent the neutrosophic fuzzy soft set  $(Q_a, K)$  and  $(Q_a, K)^c$  with the matrices  $U_a$  and  $U_b$  :

$$U_a = \begin{matrix} & k_1 & k_2 \\ h_1 & [(0.47, 0.50, 0.66)] & [(0.54, 0.60, 0.75)] \\ h_2 & [(0.85, 0.95, 0.99)] & [(0.75, 0.88, 0.89)] \\ h_3 & [(0.98, 0.95, 0.69)] & [(0.65, 0.50, 0.35)] \\ h_4 & [(0.89, 0.88, 0.05)] & [(0.95, 0.89, 0.08)] \end{matrix}$$

$$U_b = \begin{matrix} & k_1 & k_2 \\ h_1 & [(0.66, 0.50, 0.47)] & [(0.75, 0.60, 0.54)] \\ h_2 & [(0.99, 0.95, 0.85)] & [(0.89, 0.88, 0.75)] \\ h_3 & [(0.69, 0.95, 0.98)] & [(0.35, 0.50, 0.65)] \\ h_4 & [(0.05, 0.88, 0.89)] & [(0.08, 0.89, 0.95)] \end{matrix}$$

Again, let us consider another neutrosophic soft set  $(Q_a, H)$  over L

where,  $Q_b: L \rightarrow Q_a(H)$  gives an approximate description of neutrosophic fuzzy soft set for the living standard according to the basic needs.

$$\begin{aligned} (Q_b, H) &= Q_b(h_1), Q_b(h_2), Q_b(h_3), Q_b(h_4) \\ Q_a(h_1) &= \{(l_1, 0.84, 0.43, 0.20), (l_2, 0.33, 0.75, 0.85), (l_3, 0.85, 0.84, 0.03)\} \\ Q_a(h_2) &= \{(l_1, 0.96, 0.70, 0.36), (l_2, 0.45, 0.66, 0.85), (l_3, 0.99, 0.85, 0.25)\} \\ Q_a(h_3) &= \{(l_1, 0.30, 0.45, 0.70), (l_2, 0.95, 0.95, 0.30), (l_3, 0.20, 0.38, 0.88)\} \\ Q_a(h_4) &= \{(l_1, 0.33, 0.58, 0.78), (l_2, 0.98, 0.77, 0.99), (l_3, 0.39, 0.68, 0.71)\} \end{aligned}$$

Now,

$$\begin{aligned} (Q_b, H)^c &= Q_a(h_1)^c, Q_a(h_2)^c, Q_a(h_3)^c, Q_a(h_4)^c \\ Q_a(h_1)^c &= \{(l_1, 0.20, 0.43, 0.84), (l_2, 0.85, 0.75, 0.33), (l_3, 0.03, 0.84, 0.85)\} \\ Q_a(h_2)^c &= \{(l_1, 0.36, 0.70, 0.96), (l_2, 0.85, 0.66, 0.45), (l_3, 0.25, 0.85, 0.99)\} \\ Q_a(h_3)^c &= \{(l_1, 0.70, 0.45, 0.30), (l_2, 0.30, 0.95, 0.95), (l_3, 0.88, 0.38, 0.20)\} \\ Q_a(h_4)^c &= \{(l_1, 0.78, 0.58, 0.33), (l_2, 0.99, 0.77, 0.98), (l_3, 0.71, 0.68, 0.89)\} \end{aligned}$$

The set represents the complement of the neutrosophic fuzzy soft set  $(Q_b, H)$ . Now, we will represent the neutrosophic fuzzy soft set  $(Q_b, H)$  and  $(Q_b, H)^c$  with the matrices  $V_a$  and  $V_b$  :

$$V_a = \begin{matrix} & h_1 & h_2 & h_3 & h_4 \\ l_1 & [(0.84, 0.43, 0.20)] & [(0.96, 0.70, 0.36)] & [(0.30, 0.45, 0.70)] & [(0.33, 0.58, 0.78)] \\ l_2 & [(0.33, 0.75, 0.85)] & [(0.45, 0.66, 0.85)] & [(0.95, 0.95, 0.30)] & [(0.98, 0.77, 0.99)] \\ l_3 & [(0.85, 0.84, 0.03)] & [(0.99, 0.85, 0.25)] & [(0.20, 0.38, 0.88)] & [(0.39, 0.68, 0.71)] \end{matrix}$$

$$V_b = \begin{matrix} & h_1 & h_2 & h_3 & h_4 \\ l_1 & [(0.20, 0.43, 0.84)] & [(0.36, 0.70, 0.96)] & [(0.70, 0.45, 0.30)] & [(0.78, 0.58, 0.33)] \\ l_2 & [(0.85, 0.75, 0.33)] & [(0.85, 0.66, 0.45)] & [(0.30, 0.95, 0.95)] & [(0.99, 0.77, 0.98)] \\ l_3 & [(0.03, 0.84, 0.85)] & [(0.25, 0.85, 0.99)] & [(0.88, 0.38, 0.20)] & [(0.71, 0.68, 0.39)] \end{matrix}$$

Thus, the product of the matrices  $W_a$  and  $W_b$  are given as





**Boobalan and Afrine.N.S.Shiny**

$$W_a = \begin{matrix} & k_1 & k_2 \\ l_1 & (0.85,0.70,0.66) & (0.75,0.70,0.70) \\ l_2 & (0.95,0.95,0.69) & (0.95,0.77,0.35) \\ l_3 & (0.85,0.85,0.66) & (0.75,0.85,0.71) \end{matrix}$$

$$W_b = \begin{matrix} & k_1 & k_2 \\ l_1 & (0.69,0.70,0.84) & (0.36,0.70,0.65) \\ l_2 & (0.85,0.95,0.47) & (0.85,0.77,0.54) \\ l_3 & (0.69,0.85,0.85) & (0.35,0.85,0.65) \end{matrix}$$

Now, We find the matrices of membership value (T)(possible), indeterminacy value(I)(chances of possible or not possible) and non-membership value(F) (not possible)respectively to the matrices  $W_a$

$$W_a^T = \begin{matrix} & k_1 & k_2 \\ l_1 & [0.85 & 0.75] \\ l_2 & [0.95 & 0.95] \\ l_3 & [0.85 & 0.75] \end{matrix} \quad W_a^I = \begin{matrix} & k_1 & k_2 \\ l_1 & [0.70 & 0.70] \\ l_2 & [0.95 & 0.77] \\ l_3 & [0.85 & 0.85] \end{matrix}$$

and  $W_a^F = \begin{matrix} & k_1 & k_2 \\ l_1 & [0.66 & 0.70] \\ l_2 & [0.69 & 0.35] \\ l_3 & [0.66 & 0.71] \end{matrix}$

we observe that,  $W_a^T(k_1) \geq W_a^T(k_2)$  for the places  $l_1$  and  $l_3$  and for place  $l_2$   $W_a^T(k_1) = W_a^T(k_2)$  and  $W_a^I(k_1) = W_a^I(k_2)$  for place  $l_1$  and  $l_3$  and  $W_a^I(k_1) \geq W_a^I(k_2)$  for place  $l_2$  and for place  $l_1$  and  $l_3$   $W_a^F(k_1) \leq W_a^F(k_2)$  and  $W_a^F(k_1) \geq W_a^F(k_2)$  for  $l_2$ . Thus, the result that we have derived the place  $l_1, l_2$  and  $l_3$  are more likely to have high of status  $k_1$  (educated).

Again, We find the matrices of membership value (T)(possible), indeterminacy value(I)(chances of possible or not possible ) and non-membership value(F) (not possible)respectively to the matrices  $W_b$

$$W_b^T = \begin{matrix} & k_1 & k_2 \\ l_1 & [0.69 & 0.36] \\ l_2 & [0.85 & 0.85] \\ l_3 & [0.69 & 0.35] \end{matrix} \quad W_b^I = \begin{matrix} & k_1 & k_2 \\ l_1 & [0.70 & 0.70] \\ l_2 & [0.95 & 0.77] \\ l_3 & [0.85 & 0.85] \end{matrix}$$

and  $W_b^F = \begin{matrix} & k_1 & k_2 \\ l_1 & [0.84 & 0.65] \\ l_2 & [0.47 & 0.54] \\ l_3 & [0.85 & 0.65] \end{matrix}$

The result that we have derived is that the place  $l_1, l_2$  and  $l_3$  are more likely to be having high of status of  $k_1$  (educated).

**CONCLUSION**

In this paper, we discussed the Neutrosophic Fuzzy Soft Matrix with real life example. Also, we have used different operators such as product operator, sum operator and complement. Using these operators, we conclude that the place  $l_1, l_2$  and  $l_3$  are more likely to be having high of status  $k_1$  which is found educated.





**Boobalan and Afrine.N.S.Shiny**

## ACKNOWLEDGEMENTS

In this section you can acknowledge any support given which is not covered by the author contribution or funding sections. This may include administrative and technical support, or donations in kind (e.g., materials used for experiments).

## REFERENCES

1. K.Atanassov, Intuitionistic Fuzzy Sets, VII ITKRR's Section, Sofia (Deposed in Central Sci.Tech.Library of Bulg.Acad. of Sci.,1697/84), (1983),DOI: [https://doi.org/10.1016/S0165-0114\(86\)80034-3](https://doi.org/10.1016/S0165-0114(86)80034-3)
2. K.Atanassov, Intuitionistic fuzzy sets, Fuzzy Sets and Systems, 20, 1, (1986), 87-96, DOI: [https://doi.org/10.1016/S0165-0114\(86\)80034-3](https://doi.org/10.1016/S0165-0114(86)80034-3)
3. K.V.Babitha, and Sunil Jacob John, Genarilized intuitionistic fuzzy soft sets and its applications, Gen.Math.Notes, 7, (2), (2011), 1-14.
4. M.Bhowmik and M.Pal, Generalized intuitionistic fuzzy matrices,Far East Journal of Mathematical Sciences, 29, (3), (2008), 533-554.
5. M.Bhowmik and M.Pal, Some results on generalized interval-valued intuitionistic fuzzy sets, International Journal of Fuzzy Systems, 14, (2), (2012), 193-203.
6. Broumi Said and Florentin Smarandache, Intuitionistic Neutrosophic Soft Set, Journal of Information and Computing Science, 8, (2), (2013), 130-140.
7. T.Gandhimathi, Intuitionistic Fuzzy Matrix In Medicine, Journal of Applied Science and Computations, 6, (2), 2019, 1693-1699.
8. K.H.Kim and F.W.Roush, On generalized fuzzy matrices,Fuzzy Sets and Systems, 4, (1980), 293-375,DOI: [https://doi.org/10.1016/0165-0114\(80\)90016-0](https://doi.org/10.1016/0165-0114(80)90016-0)
9. P.K.Maji,R.Biswas and A.R.Roy, Fuzzy Soft Set, The Journal of Fuzzy Mathematics, 9, (3), (2001), 589-602.
10. P.K.Maji,R.Biswas and A.R.Roy, Intuitionistic Fuzzy soft sets,Journal of Fuzzy mathematics,12, (2004), 669-683.
11. Mamoni Dhar, Neutrosophic Soft Matrices and Its Application in Medical Diagnosis,Journal of Fuzzy Extension and Applications, 2, (1), (2021), 23-22.
12. Manash Jyoti Borah, Tridiv JyotiNeog, Dushman Kumar Sut, Fuzzy soft matrix theory and its Decision making, IJMER, (2011), 2258-2263.
13. D.Molodtsov, Soft set theory-first result, Computers and Mathematics with Applications, 37, (1999), 19-31
14. Murugadas.P and K.Lalitha, Decomposition of an intuitionistic fuzzy matrix using implication operators, Annals of Fuzzy Mathematics and Informatics,11, (1), 11-18
15. P.Murugadas,K.Balasubramanian and N.Vanmathi,Decomposition of Neutrosophic Fuzzy Matrices, JETIR, 6, (3), (2019), (ISSN-2349-5162).
16. Pabitra Kumar Maji, Neutrosophic Soft set, Annals of Fuzzy Mathematics and Informatics, 5, (1), (2013),157-168.
17. Rajarajeswari. P and Dhanalakshmi. P, Intuitionistic Fuzzy Soft Matrix Theory and Its Application in Decision Making, International Journal of Engineering Research and Technology (IJERT), 2, (4), (2013).
18. Rathika. R and Subramanian. S, An Application of Intuitionistic Fuzzy Soft Matrix Theory in Decision Making Based on Real Life Problem, International Journal of Engineering Research and Technology (IJERT), 5, (4), (2017).
19. Sanchez. E, Resolution of composite fuzzy relation equations, Information and Control, 30, (1976), 38-48, DOI: [https://doi.org/10.1016/S0019-9958\(76\)90446-0](https://doi.org/10.1016/S0019-9958(76)90446-0)
20. Sanchez. E, Inverse of Fuzzy relations: Application to Possibility Distributions and Medical Diagnosis, Fuzzy Sets and Systems, 2, (1979), 75-86, DOI: [https://doi.org/10.1016/0165-0114\(79\)90017-4](https://doi.org/10.1016/0165-0114(79)90017-4)
21. Smarandache. F, A Unifying Field in Logics, Neutrosophy; Neutrosophic Probability, Set and Logic.Rehoboth: American Research Press, (1999).
22. Smarandache.F, Neutrosophic Probability Neutrosophy Set, and Logic,ProQuest Information and Learning, Ann Arbor, Michigan,USA,1





**Boobalan and Afrine.N.S.Shiny**

23. Sumathi. I.R. and Arockiarani.I, New Operations on Fuzzy Neutrosophic Soft Matrices, International Journal of Innovative Research and Studies, 3, (12), (2014), 2319-9725.
24. Thomason. M.G, Convergence of powers of Fuzzy Matrix, J.Math Anal Appl, 57, (1977), 476-480.
25. Turksen, Interval valued fuzzy sets based on normal forms, Fuzzy Sets and Systems, 20, (1986), 191-210.
26. Virgin Raj. A and Ashok. S, Intuitionistic Fuzzy Soft Matrix Theory and its Application in Human Life, International Journal of Computing Algorithm, 3, (3), (2014), 208-210.
27. Im. Y.B, Lee. E.P and Park. S.W, The determinant of square intuitionistic fuzzy matrices, Far East Journal of Mathematical Sciences, 3, (5), (2001) 789-796
28. Yildiary Celik, A Model For Medical Diagnosis via Fuzzy Neutrosophic Soft Sets, Asian Journal of Mathematics and Computer Research, 10, (1), (2016), 60-68.
29. Zadeh.L.A, Fuzzy Sets, Information and control, 8, (3), (1965), 338-353, DOI:https://doi.org/10.1016/S0019-9958(65)90241-X





## Analyzing How Rewards Drive Knowledge Sharing: An Evaluation of Reward Systems in Indian Organizational Context

Sadhna Chauhan<sup>1\*</sup> and Monika Gulati<sup>2</sup>

Assistant Professor, Department of MMIM, Maharishi Markandeshwar University, (Deemed to be University), Mullana, Haryana, India.

Received: 22 Jan 2024

Revised: 09 Feb 2024

Accepted: 08 May 2024

### \*Address for Correspondence

#### Sadhna Chauhan

Assistant Professor,  
Department of MMIM,  
Maharishi Markandeshwar University,  
(Deemed to be University),  
Mullana, Haryana, India.  
Email: sadhna0101@gmail.com



This is an Open Access Journal / article distributed under the terms of the **Creative Commons Attribution License (CC BY-NC-ND 3.0)** which permits unrestricted use, distribution, and reproduction in any medium, provided the original work is properly cited. All rights reserved.

### ABSTRACT

Preset of dynamic changing world and technology contributed sense of security and confinedness. In this digital age with the progression of globalization it's really difficult for an organisation to be in race and to achieve the goal. Organisations mostly gets profits from what it knows, how efficiently it uses and how quickly organization shares knowledge to achieve the objectives. Knowledge sharing behavior in organisations deals with various dimensions and extents. The current research mainly focused upon how an organisation can use reward system as an asset tool in order to enhance the knowledge sharing behavior in turn is an effective tool to gain advantage. The core perception lies to explore the relationship among knowledge sharing behavior and reward system. The investigation is built on primary data collected from Indian service organisations supporting structured questionnaire.

**Keywords:** Knowledge, knowledge sharing behavior, reward system, Indian organisations

## INTRODUCTION

In a knowledge-based economy, an organization is the one, who not only absorbs knowledge, but also learns, recollects and take actions on best suited available knowledge and information. Jackson, et. al (2006) cited that knowledge sharing behavior (KSB) is one of the prime focused activities is known as the fundamental means through which Employees play a crucial role in enhancing an organization's competitive edge through knowledge application and innovation. Davenport and Prusak (1998) emphasize that when employees share knowledge within and across teams, organizations can effectively utilize their knowledge-based resources. According to Wang and Noe



**Sadhna Chauhan and Monika Gulati**

(2010), the Knowledge Sharing Behavior (KSB) of employees involves attitudes, skills, abilities, and experiences that aid in solving tasks, generating new ideas, and implementing policies. Ahmed et al. (2018) highlight Knowledge Sharing Behavior as a valuable tool not only for individual development but also for the overall competence of organizations. The ability of organizations to share and manage knowledge is essential for gaining a competitive advantage, as they rely on their employees for knowledge creation. Additionally, knowledge sharing plays a significant role in organizational contributions and team effectiveness (Huang, 2020).

**Behavior of Sharing Knowledge**

The notion behind knowledge sharing behavior, at this juncture turn out to be vigorous for organizations so that they can regulate the contribution and association of employees. Although knowledge from eternities is regarded as an intellectual asset. Goh S.K and Jayaraman. K (2020) quoted the positive effect of KSB on creative performance of employees as well as on competency of organisations. There is ample amount of knowledge everywhere but the ability to use it is infrequent or we can say it is limited up to an extent. Organisations mostly gets profits or sustainable advances as ofIn effective collaboration, organizations leverage the collective knowledge they possess, utilizing existing information while rapidly assimilating and applying new insights to fulfill their goals. It is crucial to recognize that organizations, in isolation, cannot generate knowledge; rather, they depend on their workforce to gather, generate, and disseminate knowledge in their daily operations. Consequently, it can be affirmed that knowledge sharing serves as the foundation for Knowledge Management (KM) (Ahmad, 2006). Consequently, knowledge sharing has evolved into a mutually beneficial process where individuals exchange their unique skills or valuable insights, receiving something of value in return (Christensen, 2005).

**Knowledge Sharing and Rewards**

Amin (2011) delved into the significance of knowledge sharing within the framework of knowledge management. The research examined various factors crucial to knowledge sharing, including organizational structure, climate, size, Information Technology, rewards, stressors, and job-related aspects, all of which directly influence the sharing of knowledge within an organization. Ahuja (2020) found that verbal and extrinsic rewards significantly impact knowledge sharing behavior, with monetary rewards playing a particularly significant role. Alam, Abdullah, Ishak, and Zain (2009) focused on knowledge sharing behavior in manufacturing industries, highlighting that reward systems, organizational culture, trust, and technology are key factors influencing knowledge sharing within firms. The exchange of knowledge among individuals indirectly contributes to the generation of new ideas or knowledge creation, benefiting organizational management. Ghosh and Ghosh (2009) observed that India is progressively transitioning toward a knowledge-based economy, aided by the Indian Government's support in fostering a culture of knowledge sharing. Islam, MA, Jantan, AH et al. (2018) concluded that rewards have a high impact on knowledge sharing behavior, recommending organizations to create opportunities and programs that establish knowledge sharing as a common practice across all levels and departments.

Jacobs and Roodt (2007) asserted that knowledge sharing plays a vital role in predicting turnover intentions. Employers should focus on the importance of human being on the in the process of knowledge management. Organisational culture should be managed in such a way that employees get the opportunities to share knowledge. Keith Patrick and Dotsika (2007) suggested that we can develop the support systems that increases collaboration and knowledge sharing. The study also indicate that if we use the system development process by knowledge sharing within the organization for solving the problems then we can get unexpected positive outcomes. The study gives stress on enhancement of the collaborative relationships and increases the probability of sharing through employee engagement and empowerment. Cyr and Choo (2010) propose that an individual's inclination to share knowledge is influenced by personal preferences, perceptions of costs and benefits, and the structural relationship with knowledge recipients. They view knowledge sharing as a social exchange involving considerations of costs and benefits, preferences in sharing outcomes, and the relationship with the sharing target, such as a superior or colleague. Oye, Mazleena, and Noorminshah (2011) suggest that motivators and demotivators impact knowledge sharing in the workplace. Factors like age, culture, and industry influence knowledge sharing among employees. Motivators include intrinsic elements like a sharing nature, reward systems, job security,



**Sadhna Chauhan and Monika Gulati**

professionalism, social ties, mutual benefit, and extrinsic factors such as performance reviews. Demotivating factors involve protecting one's edge, concerns about job security, personal ties, personal ill feelings, intrinsic issues like shared knowledge not being accepted, and extrinsic factors like a lack of a sharing culture. Ahmada, Sharom, and Abdullah (2006) propose that individual attitudes, organizational environment, reward systems, and information and communication technology contribute to knowledge sharing behavior, with a higher emphasis on individual attitude. Bock and Kim (2002) emphasize the need for organizations to leverage the tacit knowledge of skilled employees to stay competitive, requiring a conscious effort to convert individual knowledge into organizational knowledge through intentional sharing. Agarwal, Joshi, and Gupta (2012) assert that understanding factors that motivate and demotivate employees to share knowledge is crucial for continuous organizational growth. While economic benefits and collaboration negatively influence knowledge sharing, social factors have a more significant impact. Shoemaker (2011) notes that extrinsic rewards play a motivating role in knowledge sharing, and specific rewards can enhance individuals' sharing behaviors, contributing to the success of knowledge management programs. Kwakye and Nor (2010) highlight that reluctance in sharing cognitive knowledge is influenced by individual and social factors, including organizational culture, reward systems, trust, reputation, and technology within the organization. Amin (2011) underscores the importance of knowledge sharing as a key element in the knowledge management process, influenced by factors such as organizational structure, environment, size, technology, reward policies, and job characteristics. Sajevea (2014) emphasizes the significance of rewards and appreciation, such as a sense of belonging and shared values, achievement, and success, in fostering knowledge sharing among employees. Hon, Fung, and Senbeto (2021) advocate for a proactive personality driven by autonomous motivation for knowledge sharing, while Silva, Mosquera, and Soares (2022) stress the positive association between intrinsic factors like affiliation, enjoyment, and attitude towards knowledge sharing and knowledge-sharing behavior

**OBJECTIVE OF THE STUDY**

Objectives serve as a basic tools for the study which are necessary to provide elucidations exist in the research problem. The study aligned in direction through its objectives to describe scope and extent of the study which are as follows:

- To examine the correlation between the reward system and employees' knowledge-sharing behavior in Indian organizations.
- To explore how the reward system influences the knowledge-sharing behavior of employees in Indian organizations.

**RESEARCH METHODS****Sample and Sample Profile**

The study was based on information directly gathered from individuals through a carefully designed questionnaire. We collected responses from a group of 420 employees employed in various service sector organizations in India. The questionnaire measured the related variables of knowledge sharing behavior through offline methods and online methods targeting Indian service sectors cited Delhi, Noida, Gurgaon, Chandigarh Regions of Haryana and Punjab from Banks, Consulting firms, Universities, Telecom and Telecasting, BPO (Business Process Outsourcing), IT firms, and Hospitals etc. The research further explains individual and organisational factors collected through distinct culture to have an enlarged influence over validity of the study.

**COLLECTION OF THE DATA**

This study draws upon two types of information – Primary and Secondary. Secondary data was gathered from various sources such as journals, theses (both published and unpublished), websites, research articles in magazines, and newspapers. In addition to this, we conducted a survey to collect primary data. To gather this data, we used a well-designed questionnaire aimed at understanding the perspectives of employees. We focused on individuals at different organizational levels – top, middle, and operative. This approach was chosen because employees in these



**Sadhna Chauhan and Monika Gulati**

roles are more likely to have insights into knowledge management practices and sharing behaviors within the organization.

**RELIABILITY AND VALIDITY**

Before distributing the questionnaire to organizations, we made sure it was reliable. We conducted a trial run, a pilot study, in a few Indian service organizations. The participants were asked to review the questionnaire and provide feedback on any unclear parts or questions. To ensure the reliability of the data collected, we used Cronbach's alpha, a statistical measure calculated through SPSS. The Cronbach's alpha value we obtained was 0.880, and according to Field (2000), a value greater than 0.80 indicates significant reliability. To make sure our data is suitable for analysis and interpretation, we also checked for data normality. Ensuring the data follows a normal distribution is a fundamental requirement for accurate analysis. Validity, which assesses if the instrument measures what it claims to measure, was addressed in our study. We focused on inter-item reliability and inter-observer reliability to ensure the validity of our findings. This means that we paid attention to consistency in responses among different items in the questionnaire and among different individuals observing the same phenomenon.

**ANALYSIS**

The statistical tool like mean, median, mode, correlation and regression are used to give an insight into different dimensions of the study. In the present study mean has been used extensively to access responsiveness level and opinion of employees' regarding readiness and effectiveness of knowledge sharing behavior and knowledge management practices. Further analytical tools like Factor analysis and T-test has been used. Factor analysis has been used to reduce the data. The present study worked on five knowledge management practices and four dimensions of knowledge sharing behavior which are a result of clubbing similar sorts of variables in factor analysis. In addition to this next, T-test and ANOVA has been applied to determine the significance of difference in employees' status among two genders, among public and private sector, among Indian and MNCs organization, less experienced to most experienced employee from top level to operative level and from technical to non-technical job category etc. Further to find out the effect and relationship between the dimensions of two variables knowledge management and knowledge sharing behavior correlation and regression has been applied.

**SAMPLE SUMMARY**

- **Gender:** Among the 420 respondents, 64% were male (270), and 36% were female (150).
- **Age:** We observed differences in age groups, with 30.9% below 25 years, 40.4% aged between 25-34 years, and 28.5% above 34 years.
- **Academic Qualification:** In terms of education, 21.6% had a background in Arts/Humanities, 50.0% in Science/Engineering, 20.4% in Commerce/Management, and 7.8% in other fields.
- **Marital Status:** About 42.8% of participants were married, while 57.1% were unmarried.
- **Work Experience:** Participants with less than 5 years of experience constituted 47.3%, those with 6-10 years were 30.9%, and those with over 10 years were 21.6%.
- **Type of Organization:** The breakdown was 35.7% in public organizations and 64.2% in private organizations.
- **Category of Organization:** Among the organizations, 52.3% were Indian, and 47.6% were multinational.
- **Managerial Cadre:** Looking at job levels, 11.9% were in top-level management, 65.4% in middle-level, and 22.6% in operative level.
- **Job Category:** Job roles varied, with 33.0% in technical roles, 34.2% in semi-technical, and 32.6% in non-technical positions. This information was gathered through a well-structured questionnaire, ensuring a comprehensive understanding of our diverse participant group.

**HYPOTHESIS OF THE STUDY**

The term hypothesis guides to predictable explanation of the phenomenon. The literature review and hypothesis have been framed as per the objectives which are mentioned above in the study. Thus, to explore the dimensions of





**Sadhna Chauhan and Monika Gulati**

knowledge sharing behavior and reward system. The required hypotheses (H1) along with various sub-hypotheses to achieve the objectives of the study are mentioned under:

**REWARD SYSTEM AND ORGANISATIONAL FACTORS**

H1 “There is a significant difference in the reward system dimension of knowledge sharing behavior according to employees’ individual and organisational factors

H1<sup>a</sup> ‘There is a significant difference in the reward system dimensions of knowledge sharing behavior according to type of the organization’

H1<sup>b</sup> ‘There is a significant difference in the reward system dimensions of knowledge sharing behavior according to category of the organization’

H1<sup>c</sup> ‘There is a significant difference in the reward system dimensions of knowledge sharing behavior according to managerial cadre’

H1<sup>d</sup> ‘There is a significant difference in the reward system dimensions of knowledge sharing behavior according to work experience’

H1<sup>e</sup> ‘There is a significant difference in the reward system dimensions of knowledge sharing behavior according to job category.’

The table: 2 characterized the no significant variation (t-value=.504, P=.613) in set of type of organisation in which mean of public organisation (mean=3.46) is less than of private organisation (mean=3.56). In concern to category of organisation mean of Indian organisation (mean=3.52) is slightly higher than of multinational organisation (mean=3.51) with no significant difference in category of organisation in relation to reward system dimension of knowledge sharing behavior. In addition to this there is significant variation (Welch value=4.13, P=.018) in terms of managerial cadre in which mean of employees who belong to middle level (3.54) is higher than of operative level (3.47) and top level (mean=3.26). Thus, hypothesis H1<sup>c</sup> is supported by the results of managerial cadre factor in reward system dimension of knowledge sharing behavior. There is one more significant variation with respect to work experience (Welch Value=20.8, P=.000) where mean of employees having experience from 6-10 years is (mean=3.61) is higher than of employees with experience less than 5 years (mean=3.60) and with experience more than 11 years (mean=3.10). Here, hypothesis H1<sup>d</sup> is supported by the results of reward system dimension of knowledge sharing behavior. At the end, in case of job category mean of technical (3.67) is higher than semi-technical (mean=3.62) and non-technical (mean=3.22) and having significant variation (Welch Value=22.7, P=.000). Henceforth, the hypothesis H1<sup>e</sup> is supported by the results of reward system dimension of KSB.

**Regression Analysis for Reward System**

Table No. 3 explains the predictability model of reward system for KSB where the value of Adjusted R<sup>2</sup> .46 explains that 46 percent factors of reward system are having a significant role while determining knowledge sharing behavior. Next, from the table of analysis of variance (ANOVA), test it is predicted that the sig. value of .05 is greater than the calculated significant value of 0.000 which bargains for a significant correlation between the dependent and independent variable i.e. knowledge sharing behavior with respect to reward system. Coefficient analysis table suggests the relationship between dependent and independent variables. As per the calculated significant value reward is found to be significant and positive relationship as table significant value of 0.05 is greater than the calculated significant value. Hence the regression equation comes out to be as follows:

**Regression Equation: KSB=2.713+ .315 (reward system)**

**Implications**

Herewith, in line with the above analysis of knowledge sharing behavior, we encircled to sum up a significant and positive effect of knowledge sharing behavior and reward system. So, the hypothesis H1<sup>1</sup> there is significant effect of reward system, on knowledge sharing behavior is accepted. This further suggests KSB is majorly influenced by intrinsic and extrinsic rewards, management recognition, promotions and job security. In order to develop competent Knowledge base in organisations Reward management and Recognition for KSB can be an essential tool



**Sadhna Chauhan and Monika Gulati**

for its effectiveness. The implications of the current study of knowledge sharing behavior in organisations can effect into providing knowledge friendly culture, participation of seniors and managers in encouraging sharing among individual has a major consequences, facilitation of new ideas and new information without fear, appointment of knowledge officer to have a check, making team performance more imperative than the individual performance, reliability in knowledge sharing technology tools and facilitation of financial rewards is assessed to give an insight into service sector. The identification of this processes helps businesses to give prominence in these variables for a healthy and fruitful knowledge sharing behavior in their respective organizations.

**CONCLUSION AND FUTURE RESEARCH DIRECTIONS**

The survey used in this research, has included seven main categories of Indian service sector. For future more categories can be covered. A number of large organisations may perhaps not be less responsive towards the survey and they inhibit their selves to reveal about internal knowledge management practices data. On the other side, small IT organizations did not respond well while filling the questionnaire and also shows less involvement of companies in proper knowledge management system. For, upcoming research perspectives involvement of more sectors apart from service sector can be considered. Apart from web and mail methods in order to approach respondent's efforts may be thru to collect data from other respondents in order to make comparison. Inclusion of engineering industry and manufacturing industry etc. may be added and to see variations between different sectors. The number of questions in questionnaire can be reduced to increase the response rate from employees. In order to develop regression model more variables can be used. The research techniques used like factor analysis through SPSS, one-way ANOVA, correlation and regression can further be replaced by AMOS and SEM to find out the significance of knowledge management and knowledge sharing behavior of employees. As the current study includes primarily service sector of northern area, other regions may be explored in order to do the comparison between regions. We can further think up of adding variety of industries apart from BPO, IT and Education like maintenance, consultancies and operation.

**REFERENCES**

1. Ahmad, H., Sharomb, N. and Abdullah, C.S. (2005). "Knowledge Sharing Behaviour in the Public Sector: the Business Process Management Perspectives", *Information Resources Management Journal*, Vol. 15, No. 2, pp. 14-21.
2. Ahmed, Y.A., Ahmad, M.N., Ahmad, N., Zakaria, N.H., (2018). "Social Media for KnowledgeSharing: A Systematic Literature Review, *Telematics and Informatics*" doi: <https://doi.org/10.1016/j.tele.2018.01.015>.
3. Al-Alawi, A.I., Al-Marzooqi, N.Y., Mohammed, Y.F., (2007), "Organizational culture and knowledge sharing: critical success factors" *Journal of Knowledge Management*, Vol. 11, No. 2, pp. 22 – 42.
4. Alam, S.S., Abdullah, Z. , Ishak, A. N. and Zain, M.Z. (2009). "Assessing Knowledge Sharing Behaviour among Employees in SMEs: An Empirical Study", *International Business*
5. Alavi, M., & Leidner, D. E. (2001), "Review: Knowledge Management and Knowledge Management Systems: Conceptual Foundations and Research Issues", *MIS Quarterly*, Vo.25, No.1, pp. 107-136.
6. Alice H. Y. Hon, Clare P. Y. Fung & Dagnachew L. Senbeto (2022). "Willingness to share or not to share? Understanding the motivation mechanism of knowledge sharing for hospitality workforce", *Journal of Hospitality Marketing & Management*, Vol.31, No.1, pp.77-96, DOI: 10.1080/19368623.2021.1935384.
7. Amin. A. et al. (2011). "Knowledge Sharing: Two-Dimensional Motivation Perspective and the Role of Demographic Variables", *Journal of Information and Knowledge Management*, Vol. 10, No.2, pp. 135-149.
8. Argote, L., Ingram, P., Levine, J.M., and Moreland, R.L. (2000). "Knowledge Transfer in Organizations: Learning from the Experience of Others," *Organizational Behaviour and Human Decision Processes*, Vol. 82, No. 1, pp. 1-8.



**Sadhna Chauhan and Monika Gulati**

9. Arora, E. (2011). "Knowledge Management in Public Sector", *Researchers World-Journal of Art and Science*, Vol. 2, No.1, pp. 1-7.
10. Arthur, J. and Kim, O.D., (2005). "Gain Sharing and Knowledge Sharing: The Effects of Labor Management Corporation", *International Journal of Human Resource Management*. Vol.19, No.1, pp. 1564-1582.
11. Bhatt, S. (2013). "Knowledge Management Practices in Indian IT sector", *Thesis submitted to Aligarh Muslim University And Indian Institute of Technology, Delhi*.
12. Chauhan, S., Punia, B.K. (2016) "A Study on Knowledge Management of Employees' sloping Vocational Dynamics", *International Journal of Management and Social Science*, Vol. 3, No. 2, pp. 182-196.
13. Chauhan, S., Punia B.K. (2021) "Concurrence of Employees' Knowledge Sharing Behavior aligning Organisational notions", *Journal of Emerging technologies and innovative research*, Vol. 8., Issue 8. 2021.
14. Chauhan, S., Punia B.K (2017) "Delineating Knowledge Management in Alliance to its Practices": A Review *International Journal of Knowledge management and Practices*, Vol.5, No.1, 2017.
15. Chawla, Ashima, Sexena, S. (2013). "Knowledge Management Practices in Higher Education in India", *Thesis Submitted to Guru Jambheshwar University of Science and Technology, Hisar*.
16. Chen, I. Y. L., Chen, N.-S., & Kinshuk (2009). "Examining the Factors Influencing Participants' Knowledge Sharing Behavior in Virtual Learning Communities", *Educational Technology & Society*, Vol. 12, No. 1, pp. 134-148.
17. Cheng, C.M., and Chen, L.J. (2007). "A Study on the Knowledge Sharing of Health Technology for Technological College Students' Mobile Learning," *International Journal of Education and Information Technologies* Vol.1, No. 1, pp. 24-29
18. Christensen, H.P. (2007). "Knowledge Sharing: Moving away from the Obsession with Best Practices", *Journal of Knowledge Management*", Vol. 11, No. 1, pp. 36-47.
19. Darroch, J. & McNaughton, R. (2002). Examining the link between knowledge management practices and types of innovation. *Journal of Intellectual Capital*, Vol. 3, No. 3, pp. 210 – 222.
20. Darroch, J. (2005). Knowledge management, innovation and firm performance. *Journal of Knowledge Management*, Vol. 9, No. 3, pp. 101-115.
21. Gupta A.K. and Govindarajan V. (2000), 'Knowledge flows within multinational corporations', *Strategic Management Journal*, Vol. 21, pp. 473-496.
22. Gupta, B. (2008). "Role of Personality in Knowledge Sharing and Knowledge Acquisition Behaviour" *Journal of the Indian Academy of Applied Psychology*, Vol. 34, No.1, pp. 143-149.
23. Gupta, B., Joshi, S., Agarwal, M. (2012). "The Effect of Expected Benefit and Perceived Cost on Employees' Knowledge Sharing Behaviour: A Study of IT Employees in India", *Organizations and Markets in Emerging Economies*, Vol. 3, No. 1, pp. 8-19.
24. Ipe, M. (2003) "Knowledge sharing in organizations: A conceptual Framework", *Human Resource Development Review*, Vol. 2, No.4, pp. 337-359.
25. Islam, MA, Jantan, AH, Md Khan, A, Rahman, MH and Monshi, O (2018) Impact of motivational factors on knowledge sharing behaviour of managers in Ready Made Garments (RMG) Industry of Bangladesh. *Journal of Business and Retail Management Research*, 13 (1). pp. 179-189.
26. Islam, Z. M., Ahmed M.S., Hasan I. and Ahmed, U.S. (2011). "Organizational Culture and Knowledge Sharing: Empirical Evidence from Service Organizations", *African Journal of Business Management*, Vol. 5, No. 14, pp. 5900-5909.
27. Ismail, B. M., and Yosof, M.Z., (2009). "Demographic Factors and Knowledge Sharing Quality among Malaysian Government Officers", *Communications of the IBIMA*, Vol. 9 ISSN: 1943-7765.
28. Hussin J. Hejase<sup>1\*</sup>, Ziad Haddad<sup>1</sup>, Bassam Hamdar<sup>1</sup>, Rola Al Ali<sup>1</sup>, Ale J. Hejase and Nouri Beyrouti (2014). "Knowledge Sharing: Assessment of Factors Affecting Employee' Motivation and Behavior in the Lebanese Organizations". *Journal of Scientific Research & Reports* Vol 5, No. 12, pp. 1549-1593.





**Sadhna Chauhan and Monika Gulati**

29. Kwakye, O. E. and Nor, M.K., (2011). "Individual Factors and Knowledge Sharing", *American Journal of Economics and Business Administration*, Vol. 3, No.1, pp. 166-72.
30. Lin, C-Y., & Huang, C-K. (2020). Understanding the antecedents of knowledge sharing behaviour and its relationship to team effectiveness and individual learning. *Australasian Journal of Educational Technology*, 36(2), 89-104. <https://doi.org/10.14742/ajet.4549>
31. Lin, C. P. (2006). "Gender differs: Modeling knowledge sharing from a perspective of social network ties," *Asian Journal of Social Psychology*, Vol. 9, pp. 236-241.
32. Michailova, S. and Hutchings, K. (2006). "National cultural influences on knowledge sharing: A comparison of China and Russia". *Journal of Management Studies*, Vol. 43 No. 3, pp. 383-405.
33. Miller, D. L. and Karakowsky, L. (2005). "Gender influences as an impediment to knowledge sharing: When men and women fail to seek peer feedback," *Journal of Psychology*, Vol.139, pp. 101-118.
34. Oye, N.D., Salleh, M. Noorminshah, A. (2011). "Knowledge Sharing in Workplace: Motivators and Demotivators", *International Journal of Managing Information Technology*, Vol. 3, No. 4, pp. 28-47.
35. Punia, B.K., and Sadhna (2013) "Knowledge Sharing Behaviour and Knowledge Management: An Interactive Analysis through Literature Review", *Journal of Management & Technology*, Vol.9, No.1, pp. 86-95.
36. Sackmann, S. A. and Friesl, M. (2007) "Exploring cultural impacts on knowledge sharing behaviour in project teams - results from simulation study," *Journal of Knowledge Management*, Vol. 11 pp. 142-156.
37. Sadhna, Punia, B. K., (2016) "Employees Knowledge Sharing Behavior in Compliance to Demographic Variables", *International Journal of Commerce and Business Management*, Vol. 5, No. 3, pp. 50-59.
38. Sadhna, Punia, B.K. (2018). "A Study of Employees' Knowledge Sharing Behavior and Knowledge Management Practices in Indian Service Sector" *Guru Jambheshwar University, (Doctoral thesis)*.
39. Shoemaker, N. (2011). *The Effect of Extrinsic Rewards on Knowledge Sharing in a Team Setting*, University of North Texas: Department of Accounting College of Business. (Unpublished Doctoral Dissertation).
40. Silva, F.P.D, Mosquera, P.,Soares, E.M(2022). "Factors influencing knowledge sharing among IT geographically dispersed teams"., *Technological Forecasting and Social Change*,Vol. 174,2022,121299.
41. Soon, L. and Fraser, C. (2011), "Knowledge Sharing and Knowledge Exchange in Distance Online group", *International Journal of Information and Education Technology*, Vol. 1, No. 2, pp. 156-162.
42. Wang, S. and Noe, A. R., (2010). "Knowledge Sharing: A Review and Directions for Future Research", *Human Resource Management Review*, Vol. 20, No. 6, pp. 115–131.
43. Yadav, K. Punia, B.K. (2014). "Career Orientation and Cultural Attitude of Aspiring Managers", *Thesis Submitted to Guru Jambheshwar University of Science and Technology, Hisar*.
44. Zalk, M., Bosua, R., and Sharma, R. (2011). "Improving Knowledge Sharing Behaviour Within Organizations: Towards A Model", *ECIS 2011 Proceedings*, Paper 212, <http://aisel.aisnet.org/ecis2011/212>.

**Table: 1**

Demographics		Frequency	Percent
Gender	Male	270	64
	Female	150	36
	Total	420	100.0
Age	Below 25	130	30.5
	25-34	170	40.4
	Above 34	120	28.5
	Total	420	100.0
Academic Qualification	Arts/Humanities	91	21.6
	Science/Engineering	210	50.0
	Commerce/Management	86	20.4
	Others	33	7.8





**Sadhna Chauhan and Monika Gulati**

	Total	420	100
<b>Marital Status</b>	Married	180	42.8
	Unmarried	240	57.1
	Total	420	100
<b>Type of the organization</b>	Public	150	35.7
	Private	270	64.2
	Total	420	100.0
<b>Category of the organization</b>	Indian	220	52.3
	Multinational	200	47.6
	Total	420	100.0
<b>Work experience</b>	Below 5	199	47.3
	6-10 years	130	30.9
	Above 10 years	91	21.6
	Total	420	100.0
<b>Managerial Cadre</b>	Top Level	50	11.9
	Middle Level	275	65.4
	Operative level	95	22.6
	Total	420	100
<b>Job Category</b>	Technical	139	33.0
	Semi Technical	144	34.2
	Non -Technical	137	32.6
	Total	420	100

Source: Survey N=420

**Table-2 Reward System through organisational factors**

Variables		Reward				
		N	Mean	SD	t-Values	Sig.
Type of Organisation	Public	150	3.46	.63	t-Value .504	.613NS
	Private	270	3.56	.56		
Category of Organisation	Indian	220	3.52	.56	t-Value .154	.876NS
	Multinational	200	3.51	.62		
Managerial Cadre	Top Level	50	3.26	.76	Welch Value 4.13	.018*Sig
	Middle Level	275	3.54	.54		
	Operative level	95	3.47	.56		
Work Experience	Below 5	199	3.60	.40	Welch value 20.8	.001*Sig
	6-10	130	3.61	.60		
	More than 11	91	3.10	.64		
Job Category	Technical	139	3.67	.52	Welch Value 22.8	.000*Sig
	Semi Technical	134	3.62	.47		
	Non-Technical	137	3.22	.65		

Source: Primary data, \* Significant Level at 0.05

**Table No. 3: Regression Model for Reward System**

Model	R	R Square	Adjusted R Square	Std. Error of the estimate
1	0.678 (a)	.460	.459	.20158





**Sadhna Chauhan and Monika Gulati**

ANOVA						
Model 1	Sum of Squares		Df	Mean Square	F	Sig.
Regression	14.786		1	14.786	363.878	.000 (a)
Residual	17.351		427	0.041		
Total	32.137		428			
Coefficients						
Model 1	Unstandardized Coefficients		Standardized Coefficients	T	Sig.	
	B	Std. Error	Beta			
Constant	2.713	0.059	0.678	46.099	.000	
Reward System	0.315	.017		19.076	.000	

Predictors: (Constant), Reward System, b)Dependent Variable: overall KSB





## Inter Carrier Interference Cancellation Technique in OFDM System

K. Maheswari Devi<sup>1\*</sup> and Jogu Ramesh<sup>2</sup>

<sup>1</sup>Assistant Professor, Department of Electronics and Communication Engineering, Malla Reddy Engineering College, (Affiliated to Jawaharlal Nehru Technological University) Hyderabad, Telangana, India.

<sup>2</sup>Assistant Professor, Department of Electronics and Communication Engineering, St.Martin's Engineering College, (Affiliated to Jawaharlal Nehru Technological University) Hyderabad, Telangana, India.

Received: 22 Jan 2024

Revised: 09 Feb 2024

Accepted: 08 May 2024

### \*Address for Correspondence

**K. Maheswari Devi**

Assistant Professor,

Department of Electronics and Communication Engineering,

Malla Reddy Engineering College,

(Affiliated to Jawaharlal Nehru Technological University)

Hyderabad, Telangana, India.

Email: maheshwari.devi@gmail.com



This is an Open Access Journal / article distributed under the terms of the **Creative Commons Attribution License** (CC BY-NC-ND 3.0) which permits unrestricted use, distribution, and reproduction in any medium, provided the original work is properly cited. All rights reserved.

### ABSTRACT

Modern high data rate wireless communication systems are increasingly using Orthogonal Frequency-Division Multiplexing (OFDM) as their preferred modulation technique. The European Digital Audio and Video Broadcast Radio System has implemented OFDM, and it is currently being researched for use in broadband wireless communication networks. Because there is less complicated equalization in the receiver design, OFDM systems have excellent spectral efficiency because their sub-carrier spectra overlap. The primary idea of this work is that the influence of ICI on the distant sub-carriers is first cancelled using the symbol shift cancellation (SSC) method, and the impact of ICI on the adjacent sub-carriers interference is then cancelled using the adjacent sub-channel interference filter (ASIF) method. By processing in this way, the OFDM system's bandwidth efficiency is rarely lost and the impact of ICI is minimized. A pilot-symbol approach is presented to simplify the adjacent interference filter method and increases the accuracy of channel estimate by examining the distributions of the adjacent inter carrier interference. The results of the simulation demonstrate that the suggested method can successfully raise the OFDM system's BER (Bit Error Rate) performance. The proposed system will be implemented in MATLAB for its functional realization.

**Keywords:** OFDM, SSC, ASIF, Bit Error rate, ICI, Channel Estimation etc.





## INTRODUCTION

There doesn't seem to be a pause in the fast rising demand for high data rate services. Virtually every physical medium that is currently in use or will be used in the future is able to facilitate the transmission of broadband data to our homes, offices, and educational institutions. This covers both wireless and wired media, such as DSL, cable modems, and power lines. These services frequently need extremely dependable data transfer over extremely severe conditions in order to be robust in handling these impairments in several contexts. Numerous degradations, including significant attenuation, noise, multipath, interference, time variation, and non-linearity, are experienced by the majority of these transmission systems. Additionally, they must adhere to numerous constraints, including finite transmit power and, crucially, finite cost. One physical-layer method that has been increasingly well-known lately is carrier modulation. In order to provide clients with a range of new high-quality services, modern transceivers need to meet a number of requirements, including high capacity and variable bit rate information transfer with high bandwidth efficiency. Traditional single carrier mobile communication systems do not function well in the wireless environment because signals are typically impeded by fading and the multipath delay spread phenomenon. Extreme signal amplitude fading and Inter Symbol Interference (ISI) at the receiver end result from the frequency selectivity of these channels. As a result, there is a greater chance of errors, and the system performs much worse overall. Methods like as adaptive equalization and channel coding have been applied extensively to address these issues. However, using these approaches in systems operating at large data rates, say multiple Mbps, is rather challenging because to the inherent latency in the coding and equalization process and the high cost of the hardware. Using a multi carrier system is another method. One example of it is called orthogonal frequency division multiplexing (OFDM), which finds use in a variety of applications, including asymmetric digital subscriber lines (ADSL), a method that enables high bit-rates across copper cables with twisted pairs. It is now in use for terrestrial digital video broadcasting (DVB-T) and was recently standardized and recommended for digital audio broadcasting (DAB) in Europe. OFDM is also the foundation of the IEEE 802.11a standard for wireless local area networks (WLAN).

This project aims to study the performance of OFDM in an Additive White Gaussian Noise (AWGN) channel exclusively. In this channel, noise and constant attenuation are the only factors taken into account, and there is only one path between the transmitter and the receiver. As a result, the multipath effect is ignored. This is a preliminary study meant to serve as a foundation for a deeper knowledge of OFDM in preparation for more in-depth research on the technology in multipath channels. Among the issues that arise when utilizing these strategies to operate with wireless networks are (1) multi-path fading (2) Inter-Symbol Interference caused by temporal dispersion (ISI) (3) Interference between carriers (ICI) (4) greater transmission power needed to achieve high bit rate; and (5) lower spectral efficiency. The poor spectrum usage of the FDMA technology is one of its drawbacks. One of the drawbacks of the TDMA technology is the Multipath Delay Spread issue. The transmitted signal travels via a number of separate, varying-length pathways to reach the receiver in a typical terrestrial broadcast. It becomes challenging to retrieve the original information since different versions of the signal interfere with one another. For the aforementioned issues, the orthogonal frequency division multiplexing (OFDM) approach offers a superior solution.

## LITERATURE SURVEY

OFDM is a method that uses a lot of modulated sub-carriers to send data in parallel. These sub-carriers, often referred to as sub-channels, split the available bandwidth and have enough frequency separation (also known as frequency spacing) to be orthogonal. Each carrier has an integer number of cycles throughout a symbol period due to the carriers' orthogonality. As a result, every carrier in the system has a null in its spectrum at the center frequency of every other carrier. The carriers' spectra overlap, yet there is no interference between them as a consequence. CK. Wen et al. [1] proposed Gaussian Mixture Bayesian Learning, which indicates that the intra cell interference disappears as the BS antenna numbers rise. However, the other cells' intercellular interaction remains a consequence of system success, including the reasonable rates. Different intra-cell and inter-cell interference affect achievable pace





**Maheswari Devi and Jogu Ramesh**

following the channel measurement error and pollution of the pilot. It reduces the cumulative numbers that can be obtained. The possibilities of cell-side UTs are more degraded by their higher cross-takes than others. A channel approximation based on compressed sensing methods was exercised into account where a marginal amount of random incoherent estimates reconstructed the sparse channel vector, unlike previous attempts, more recent results [2] generalize the signal's vector sparsity design principle to the low-rank matrix variable model. The mm Waves have substantially high, hundreds of GHz bandwidth and are thus an ideal candidate for potential cellular networks. The greatest challenge in the use of mm Waves is the high propagation attenuation leading to minimum SNR at the receiving terminals [3]. For enhanced efficiency, the BS integrates large numbers of highly directive antennas. Therefore, the transition to mm Wave needs entirely different equipment designs, architectures and signal processing. The miniature wavelength of the mmWaves enables a massive count of the antennas on the BS.

Du L et al. [4] developed a low complexity hybrid LMMSE precoding that maximizes the sum rate in a multiuser scenario. Hybrid LMMSE, based upon linear successive allocation, which is a linear form of successive encoding and successive allocation method (SESAM), designs analog precoder based on the normalized intermediate solution of LMMSE and the digital precoder to mitigate the interference. By analyzing the distributions of the adjacent inter carrier interference, a pilot-symbol scheme is proposed to improve the accuracy of channel estimation and simplify the adjacent interference filter method. Simulation results show that the technique proposed can effectively improve BER (Bit Error Rate) performance of the OFDM system.

**PROPOSED SYSTEM****OFDM Transceiver Architecture**

The SSC-ASIF ICI scheme was introduced by Li Zhao and Juan Li to combat the impact of ICI on OFDM systems, both the SSC method and the ASIF method are jointed in this ICI cancellation scheme. Its transceiver architecture is shown in Fig.1. The input serial data stream is converted into a parallel format after being formatted into the word size needed for transmission, such as 2 bits/word for QAM. Next, each data word is assigned to a single carrier in the transmission, allowing the data to be delivered in parallel. Using a serial-to-parallel port, the input data stream is divided into N parallel data streams. The duration of the data is elongated by N times. Serial-to-parallel conversion is depicted in Fig. 2.

**FFT**

Fast Fourier Transform (FFT) methods are used to apply the technology in a cost-effective manner by doing away with the arrays of sinusoidal generators and coherent demodulation needed in parallel data systems. Unlike a simple computation that requires  $N^2$  multiplications, an N-point FFT only requires on the order of  $N \log N$  multiplications. Because of this, compared to an analogous system with equalization, an OFDM system usually requires less computations per unit time. The time domain samples are transformed back into a frequency domain representation using the Fast Fourier Transform (FFT). The frequency components' magnitudes match the original data. In essence, the receiver operates on the transmitter in reverse. The original transmitted spectrum is then determined by taking the FFT of each symbol. After then, each transmission carrier's phase angle is calculated, and the received phase is demodulated to transform it back to a data word. After that, the data words are merged once more to have the same word size as the initial data.

**RESULT ANALYSIS**

Fig.4 shows the BER performance of the OFDM systems with the ICI cancellation schemes has been improved obviously. The BER performance curve of the regular scheme has floor effects, but that of the two improving schemes doesn't exist in the observed range.



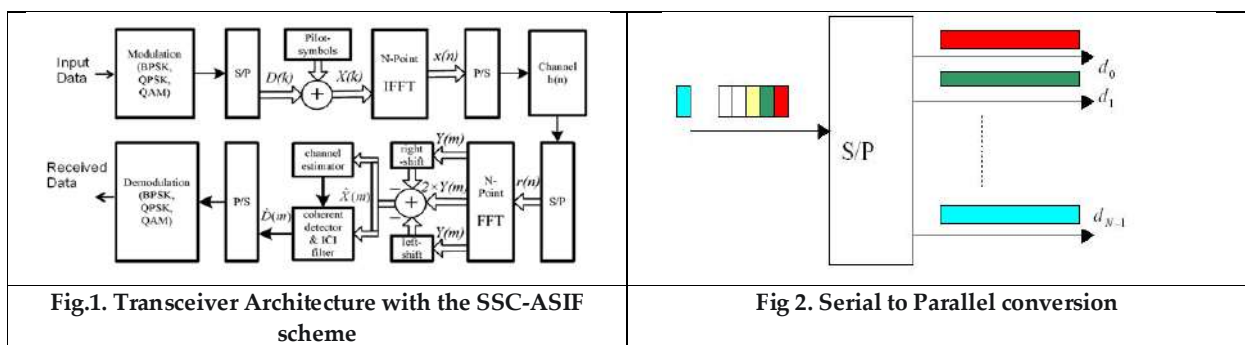


**CONCLUSION**

In comparison to a normal scheme and the SSC-ASIZ scheme, the SSC-ASIF cancellation scheme offers superior BER performance and can effectively lessen the sensitivity of the OFDM system to ICI caused by frequency offsets or spread. Its bandwidth efficiency has clearly improved as compared to the SSC-ASIZ method. In particular, the channel estimate scheme is straightforward and simple to use. The SSC-ASIF scheme is compatible with a conventional OFDM system and adds only a few circuits to it, without making the system overly complex.

**REFERENCES**

1. CK. Wen ,Y. Zhao and S-G. Haggman, "Inter carrier Interference Self-cancellation Scheme for OFDM mobile communication systems", IEEE Trans.Commun., vol.49, pp.1185-1191, 2001.
2. Hen-Geul Yeh and Yuan-Kwei Chang. "A conjugate operation for mitigating inter carrier interference of OFDM systems", Vehicular Technology Conference Proceedings, Atlanta, US,vol.6, pp.3965-3969,2004.
4. J. Ahn and H. S. Lee, "Frequency domain equalization of OFDM signal over frequency nonselective Rayleigh fading channels", Electron. Lett., vol.29, pp.1476–1477, 1993.
6. Du L ,C. Muschallik, "Improving an OFDM reception using an adaptive Nyquist windowing" IEEE Trans. Consumer Electron., vol.42, pp.259-269, 1996.
7. P. H. Moose. "A technique for orthogonal frequency division multiplexing frequency offset correction", IEEE Trans. Commun.,vol.42, pp.2908-2914, 1994.
9. Byung-Chul Kim and I-Tai Lu,"Doppler Diversity for OFDM Wireless Mobile Communications: Part II: Time-Frequency processing", Proc.IEEE VTC 2003 spring, Korea, pp.2682-2685, April, 2003.
11. J. Armstrong, "Analysis of new and existing methods of reducing inter carrier interference due to carrier frequency offset in OFDM", IEEE Trans. Commun., vol.47, pp.365–369, 1999.
13. L. Zhao and J. Li, "An Inter carrier Interference Cancellation Technique with SSC and ASIZ in OFDM Systems", 2008 International Conference on Wireless Communications, Networking and Mobile Computing. Proceedings. Vol. 4, Oct. 12-17, 2008, Dalian, China.
15. Y. Li, "Pilot-symbol-aided channel estimation for OFDM in wireless systems," IEEE Trans. Vehicular Technol., vol.49, pp.865–869, Jul.2000.





Maheswari Devi and Jogu Ramesh

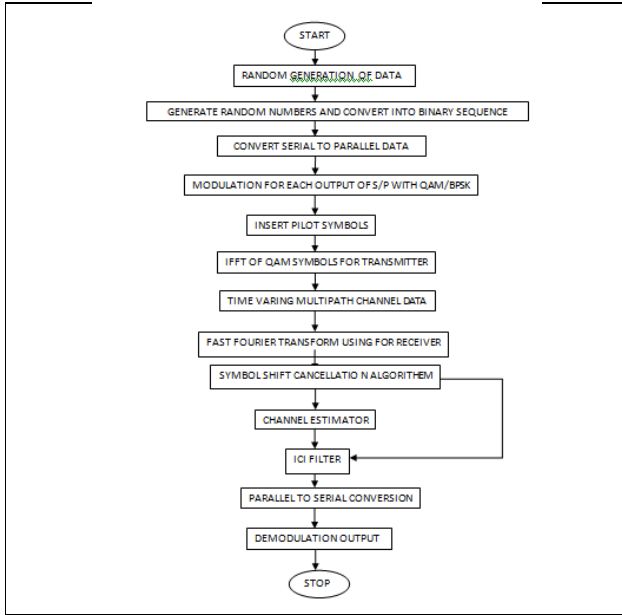


Fig 3: Flow Chart

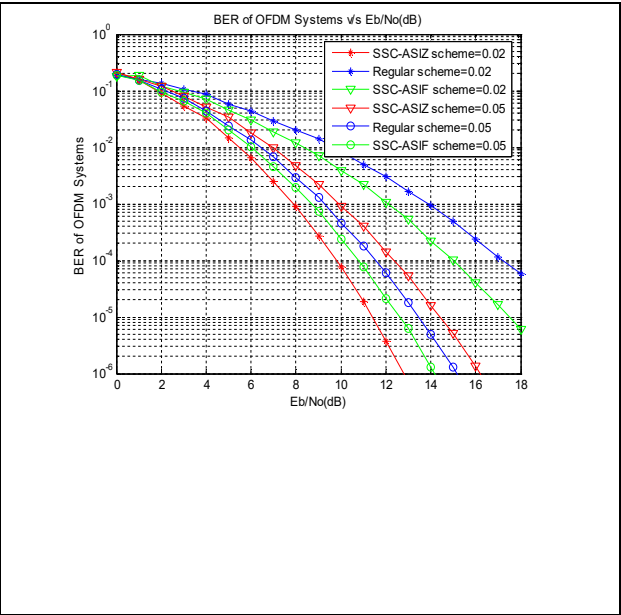


Fig. 4. BER Performance of the OFDM Systems





## Salve for Cellulitis

Shailaja Khedkar<sup>1\*</sup> and Pallavi M. Chaudhari<sup>2</sup>

<sup>1</sup>M.Pharm Student, Department of Pharmaceutics, Dr. D. Y. Patil College of Pharmacy, Akurdi, (Affiliated to Savitribai Phule Pune University) Pune, Maharashtra, India.

<sup>2</sup>Associate Professor, Department of Pharmaceutics, Dr. D. Y. Patil College of Pharmacy, Akurdi, (Affiliated to Savitribai Phule Pune University) Pune, Maharashtra, India.

Received: 22 Jan 2024

Revised: 09 Feb 2024

Accepted: 08 May 2024

### \*Address for Correspondence

#### Shailaja Khedkar

M.Pharm Student,  
Department of Pharmaceutics,  
Dr. D. Y. Patil College of Pharmacy, Akurdi,  
(Affiliated to Savitribai Phule Pune University)  
Pune, Maharashtra, India.  
Email: shailubkhedkar@gmail.com



This is an Open Access Journal / article distributed under the terms of the **Creative Commons Attribution License** (CC BY-NC-ND 3.0) which permits unrestricted use, distribution, and reproduction in any medium, provided the original work is properly cited. All rights reserved.

### ABSTRACT

Cellulitis, a ordinary and affected skin in a probably serious bacterial skin infection is bulge, burning, and usually aching and cosy to the touch. Affects over 1 million people annually in India as bacteria enter the skin. Cellulitis is usually superficial infection of the dermis that can be escalate to bloodstream and lymph nodes. If not treated correctly. The lower lakes are usually affected by cellulitis, but it can occur on the face, hands, and further areas. The contamination occurs when bacteria enter through a crack in the dermis. If left refined, the contamination can be broaden to the lymph gland and circulation, potentially becoming mortal. It is not usually contagious. A ordinary dermis contamination called cellulitis is commonly presented with personal badly define erythema, cosy, and affection, and has many detached imitator. In the management of cellulitis, complications can arise when appropriate antibiotics cannot confirm the potential microbiological causes. Inadults usual area of contamination for cellulitis is the bottom edge although any body area can be affected. Identification is generally established on a case study and chekups. There are several contagious and non-contagious detached imitator, like venous balance scab, contact dermatitis, scales, lymphatic edema, and erythema hemicrania, which can make the allergen arduous. Culture specimens often have poor sensitivity, making microbiological diagnosis unobtainable in many cases. Oral medication such as amoxicillin, penicillin and cephalixin are enough for appropriate targeted coverage of the pathogen causing the seniority of not containing pus, uncomplicated cases of cellulitis, which aremethicillin-sensitive *Staphylococcus aureus*. Or  $\beta$ -hemolytic streptococci.





Shailaja Khedkar and Pallavi M. Chaudhari

**Keywords:** Cellulitis ,Erysipeleas ,Soft tissue infection , Subcutaneous tissue infection,Erisipla.

## INTRODUCTION

Cellulitis is usually found complicating a wound, ulcer, or dermatosis. It is an unpleasant irritant state of the epidermis and hypodermic tissue. If left refined serious health problems can be caused[1-2]. Preventing cellulitis is important, and it can be achieved by practicing good wound care and maintaining proper hygiene. The arms and legs are usually affected by cellulitis, but it can also develop around the anus, mouth, eyes, or on the body. When bacteria enter the wound or an area without skin, cellulitis is usually caused.[3-4] Bacteria are most common cause of cellulitis is:-Group A and B haemolytic streptococcus are commonly associated with causing cellulitis. Strains of streptococcus pneumoniae and streptococcus aureus are usually found on dermis and epidermis of healthy individuals. Infections transpire when there is an incision in the skin that permits bacteria to enter inside, and other etiologies include animal and human bites or wounds that occur in the water.[5-7]

### Types of cellulities

- Periorbital cellulitis: The eyelid or skin around the eye can be infected in periorbital cellulitis.
- Facial cellulitis:-If it gets deeper into the tissues, tissue damage and tissue death can occur as facial cellulitis spreads from one part of the body to another
- Breast cellulitis:-Breast cellulitis is classically characterized by swelling, erythema, warmth, and tenderness, often caused by an infection from *S. aureus*.
- Perianal cellulitis:- Usually, perianal streptococcal cellulitis occurs in children.[9-15]

### Ointment

Ointments are the semisolid liquid dosage form. When shear stress is applied, ointments typically behave as viscoelastic materials. They are usually semisolid systems that are composed of medicaments and are meant to be applied externally on the body or to the mucous membrane.[15-18] Herbal ointment refers to a type of ointment that is made from natural plant-based ingredients, such as herbs, flowers, or other botanical extracts. These ointments are often used for their potential therapeutic properties and are believed to provide relief for various skin conditions or discomforts. They are a popular alternative to traditional pharmaceutical ointments because of their natural ingredients.[19]

### Herbal ointments have several advantages

1. **Natural Ingredients:** Herbal ointments are made from natural plant-based ingredients, which can be appealing to individuals who prefer using products with minimal synthetic or chemical additives.
2. **Potential Therapeutic Properties:** Many herbs used in herbal ointments are believed to have various therapeutic properties, such as anti-inflammatory, antiseptic, or soothing effects. These properties may help with skin conditions or discomforts.
3. **Reduced Risk of Irritation:** Synthetic or chemical ingredients found in some traditional ointments may cause skin irritation or allergic reactions in some individuals. Herbal ointments, on the other hand, may have a lower risk of irritation due to their natural ingredients.
4. **Customizable Formulations:** Herbal ointments can be customized by combining different herbs to address specific skin concerns or conditions, offering a more personalized approach to skincare.
5. **Holistic Approach:** Some people appreciate the holistic approach that herbal ointments offer, as they consider the connection between the body, mind, and nature. Using herbal ointments can be seen as a way to align with natural elements.[20-22]





Shailaja Khedkar and Pallavi M. Chaudhari

### How Ointment Help in Cellulitis

Ointments can help in the treatment of cellulitis by providing a protective barrier over the affected area. This barrier helps to keep the bacteria out and prevents further infection. Additionally, certain ointments may have antibacterial or anti-inflammatory properties that can help reduce the symptoms and promote healing.

## LITERATURE

Ointments can be beneficial in the management of cellulitis by creating a protective barrier on the skin, reducing moisture loss, and promoting healing. They can also contain antimicrobial ingredients that help combat bacteria. Herbal extracts used in ointments for cellulitis may have antimicrobial, anti-inflammatory, and wound-healing properties. Certain herbs like Hriviera, Shrish, and Aloe vera are believed to have these beneficial effects. They can help fight bacteria, reduce inflammation, and promote the healing of skin tissue. However, it's important to note that herbal extracts alone may not be sufficient for treating cellulitis.

### Why we need to use herbal dosage form instead of conventional dosage form ?

Using herbal dosage forms instead of conventional dosage forms can have several advantages. Herbal dosage forms, such as herbal ointments, tinctures, or capsules, are often preferred by individuals who prefer natural remedies or have a preference for plant-based products. Here are a few reasons why some people choose herbal dosage forms:

1. Natural Ingredients: Herbal dosage forms are typically made from natural plant-based ingredients, which can be appealing to those who prefer using products with minimal synthetic or chemical additives with no or minimal side effect.
2. Potential Therapeutic Benefits: Many herbs used in herbal dosage forms have been traditionally used for their potential therapeutic properties. These properties may include promoting general well-being, supporting specific body systems, or addressing certain health concerns.
3. Holistic Approach: Some individuals appreciate the holistic approach that herbal dosage forms offer, as they consider the connection between the body, mind, and nature. Using herbal remedies can be seen as a way to align with natural elements.
4. Personal Preference: Some people simply have a personal preference for herbal remedies and find them more in line with their beliefs or lifestyle choices.

### Method of preparation of ointments are Chemical reaction method, Fusion method, Trituration method.

#### Hriviera

Hriviera is an aromatic medicinal herb that is used in the treatment of various conditions such as fever, burning sensation, excessive thirst, giddiness, vomiting, and diarrhoea. Botanical Name :- *Pavonia odorata*. Family :- *Malvaceae*  
Chemical constituents:-Palmitic acid, ageratochromenehexahydrofarnesyl acetone . Dose:-The recommended dose of Hriviera is 3-6 grams. Part used :- The part used in Hriviera is the root powder. Side effects: - there are no known side effects of this herb.[24-29]

#### Shirish

This powerful herb, Shirish, is considered an Ayurvedic anti-poisonous herb and is widely recognized as the most potent antidote against a variety of animal and plant origin poisons. Its properties, such as antimicrobial and immune-modulator actions, have been proven through experiments. Botanical Name:- *Albizia lebeck* Family:- *Fabaceae*, Chemical constituents:- Tannins and pseudotannins, along with friedelin and b-sit sterol, are found in the bark of Shirish. It has been reported that saponins based on echinocystic acids have been found in the seeds. Dose :- the recommendation dose of Shirish is 3-5 gm per day 20-30 ml two times per day, Decoction:- 60-100 ml per day . Part used :-Medicinal purposes entail the use of the bark, seeds, leaves, and flowers of Shirish. Side effects:- Shirish is generally considered safe to use when taken in recommended doses. However, like any herbal remedy, there may be potential side effects or interactions with certain medications.[30-33]



**Shailaja Khedkar and Pallavi M. Chaudhari****Alovera**

The people have known and used the Alovera plant for centuries because of the benefits it offers for skin, health, and beauty. The name "Aloe Vera" is comes from the original Arabic word "Alloeh," which implies "sparkling bitter substance," whereas in Latin, "Vera" indicate "true." Aloe Vera is known for its various beneficial properties. Aloe Vera was considered the universal panacea by Greek scientists around 2000 years ago. In Presently, the Aloe Vera plant has been utilized for various purposes in dermatology. Botanical Name :- *Aloe barbadensis* Miller Family:- *liliaceae* . Dose:- 100-200 milligrams dose of alovera juice per day 50 mg dose of Aloe Vera extract per day Alovera Pulp - 1/4-1/2 teaspoon a day or as prescribed by the doctor. Part used:- A juice can be made from the green part of the leaf or it can be dried and taken orally as a laxative. Side effects:- Alovera is generally safe to use, but there can be potential side effects for some individuals. These can include diarrhoea, abdominal cramps. [34-36]

**BEE SWAX**

Honey bees of the genus *Apis* produce a natural wax called beeswax which is also known as *cera Alba*. The worker bees have eight wax producing glands in their abdominal segment and they use them to form the wax into scales, and it is disposed of or at the comb. Family:- Beeswax comes from honey bees, which are part of the *Apidae* family. Dose:- The appropriate dose of beeswax is dependent on several factors, including the consumer's age, health, and other terms. Adverse effects:- Most of individual are likely to consider beeswax safe when taken orally or topically applied. [37-38]

**HARD PARAFFIN**

Hard paraffin, also known as paraffin wax, is a type of wax that is solid at room temperature. It is commonly used in candles, cosmetics, and as a coating for fruits and vegetables. It's also used in beauty treatments like paraffin wax baths for moisturizing and softening the skin. paraffin wax is also used in industries like packaging, crayon manufacturing, and as a lubricant for things like skis and surfboards. It's even used in some medical applications, like dental casts and as a base for ointments. [39]

**SOFT PARAFFIN**

Soft paraffin, also known as petroleum jelly or Vaseline, is a semisolid mixture of hydrocarbons. It has a greasy texture and is commonly used as a moisturizer for dry skin, as a lip balm, and for minor cuts and burns. It's also used in formation of ointment. [39]

**WOOL FAT**

Wool fat, also known as lanolin, is a waxy substance derived from sheep's wool. It's a natural moisturizer and emollient that is often used in skincare products. Lanolin helps to hydrate and soften the skin, making it a popular ingredient in creams, lotions, and lip balms. It's especially beneficial for dry and rough skin, providing nourishment and restoring moisture. Wool fat is a wonderful natural ingredient for skincare. [40-41]

**CETOSTEARYL ALCOHOL**

It's a common ingredient in many skincare products. It's actually a mixture of cetyl alcohol and stearyl alcohol. Cetostearyl alcohol is often used as an emollient and emulsifier in creams, lotions, and ointments. It helps to soften and smooth the skin, giving products a nice texture.

**MARKETED PREPARATION****Antibiotics**

Cellulitis treatment commonly involves prescribing oral antibiotics like penicillin, cephalosporin's, or macrolides. Ex. Cephalexin Capsule IP 500mg (Cipla Ltd), Amoxicillin- clavulanic acid 875 mg (Aurobindo) Dicloxacillin 200-250 mg (Cipla), Penicillin VK (Sandoz).

Topical antibiotics:-

For localized cellulitis, recommendation may be made for the use of topical antibiotic creams or ointments like mupirocin, dicloxacillin. Ex. Cephalexin (Wellona Pharma), Erythromycin 250mg (Milpharm)



**Shailaja Khedkar and Pallavi M. Chaudhari**

Intravenous :- Cefazolon 1TID, Clindamycin 600mg, Penicillin G 2-4million.

**Pain reliever**

Pain relievers like ibuprofen or acetaminophen can be used to help manage pain and reduce inflammation associated with cellulitis. Ex. Tylenol 500 (Johnson and Johnson Consumer INC). It is important to have a consultation with a healthcare professional for a proper diagnosis and appropriate treatment options for cellulitis. The most suitable marketed preparations can be recommended based on the severity and specific needs of the individual case.

**CONCLUSION**

To diagnose of cellulitis doctors primarily rely on the patients history and checkup. When treating accessible cellulitis, the main focus should be on targeting *methicillin-sensitive S. Aureus* and *Streptococcus*. If there is no improvement with first-line antibiotics, consideration should be given to prosthetic being, other conditions mimicking cellulitis, or preliminary more difficult conditions such as chronic kidney disease, or chronic liver disease, immunosuppressant,. If the bacterial infection reaches the bloodstream, bacteraemia can occur. Bacteraemia is diagnosed by obtaining blood cultures in patients who show systemic symptoms

**REFERENCES**

1. 18th ed Philadelphia, PA: Elsevier Saunders; 2014: pp. 1195–215.
2. Hirschmann JV, Raugi GJ. Lower limb cellulitis and its mimics: Part I. Lower limb cellulitis. J Am Acad Dermatol 2012; 67:163.e1–12
3. Raff AB, Kroshinsky D. Cellulitis: A Review. JAMA. 2016 Jul 19;316(3):325-37. .
4. Cranendonk DR, Lavrijsen APM, Prins JM, Wiersinga WJ. Cellulitis: current insights into pathophysiology and clinical management. Neth J Med. 2017 Nov;75(9):366-378.
5. Hugo-Persson M, Norlin K. Erysipelas and group G streptococci. Infection 1987; 15:184–7.
6. Bernard P, Bedane C, Mounier M.. Streptococcal cause of erysipelas and cellulitis in adults. A microbiologic study using a direct immunofluorescence technique. Arch Dermatol 1989; 125:779–82.
7. Eriksson B, Jorup-Ronstrom C, Karkkonen K Erysipelas: clinical and bacteriologic spectrum and serological aspects. Clin Infect Dis 1996; 23:1091–8.
8. Stevens DL, Bisno AL, Chambers HF, Dellinger EP, Goldstein EJ, Gorbach SL, Hirschmann JV, Kaplan SL, Montoya JG, Wade JC. Practice guidelines for the diagnosis and management of skin and soft tissue infections: 2014 update by the infectious diseases society of America. Clin Infect Dis. 2014 Jul 15;59(2):147-59.
9. Tritt A, Kay-Rivest E, Paradis T, Duval M. Daily outpatient intravenous antibiotic therapy for the management of paediatric periorbital cellulitis, a retrospective case series. Clin Otolaryngol. 2019 May; 44(3):273-278.
10. Michael J.A., Hibbert S.A. Presentation and management of facial swellings of odontogenic origin in children. Eur. Arch. Paediatr. Dent. 2014;15:259–268. doi: 10.1007/s40368-014-0110-7.
11. Chura N. Celulitis cervicofacial de origen dentario. Rev. Act. Clin. Med. 2010;1:40–45.
12. Miller , SR, Mondry T, Reed JS, Findley A, Johnstone PA. Delayed cellulitis associated with conservative therapy for breast cancer. J Surg Oncol. 1998;67:242–245.
13. Staren ED, Klepac S, Smith AP, Hartsell WF, Segretti J, Witt TR, Griem KL, Bines SD. The dilemma of delayed cellulitis after breast conservation therapy. Arch Surg. 1996;131:651–654.
14. Zippel D, Siegelmann-Danieli N, Ayalon S, Kaufman B, Pfeffer R, Zvi Papa., M Delayed breast cellulitis following breast conserving operation. Eur J Surg Oncol. 2003;29:327
15. Paller AS, Mancini AJ. Bacterial, mycobacterial, and protozoal infections of the skin. In: Paller AS, Mancini AJ, eds. Paller and Mancini - Hurwitz Clinical Pediatric Dermatology. 6th ed. Philadelphia, PA: Elsevier; 2022:chap 14.







**Shailaja Khedkar and Pallavi M. Chaudhari**

16. Kumar M, Singh D, Bedi N. Mefenamic acid-loaded solid SMEDDS: an innovative aspect for dosereduction and improved pharmacodynamic profile. *Ther Delivery* 2019; 10:21-36.
17. Nurhikmah W, Sumirtapura YC, Pamudji JS. Dissolution profile of mefenamic acid solid dosage forms in two compendial and biorelevant (FaSSIF) media. *Sci Pharm* 2016; 84:181-90.
18. Sriamomsak P, Limmatvapirat S, Piriyaprasarth S, Mansukmanee P, Huang Z. A new emulsifying formulation of mefenamic acid with enhanced drug dissolution. *Asian J Pharm Sci* 2015; 10:121-7. .
19. Reiner, R., 1984. *Antibiotic: An Introduction*. New Horn Publishing Co. Ibadan, Nigeria, pp 172. 2. Sule, I.O., Agbabiaka, T.O., 2008. Antibacterial Effect of Some Plant Extracts On Selected Enterobacteriaceae. *Ethnobotanical Leaflets* 12: 1035-42. 3. Hawkins, E.B., Ehrlich, S.D., 2007.
20. Reiner, R., 1984. *Antibiotic: An Introduction*. New Horn Publishing Co. Ibadan, Nigeria, pp 172. 2. Sule, I.O., Agbabiaka, T.O., 2008. Antibacterial Effect of Some Plant Extracts On Selected Enterobacteriaceae. *Ethnobotanical Leaflets* 12: 1035-42. 3. Hawkins, E.B., Ehrlich, S.D., 2007.
21. Momin, A., 1987. Role of Indigenous Medicine in Primary Health Care. 1st International Seminar on Unani Medicine, New Delhi, pp 54.
22. Carter, S.J., 1987. *Cooper and Gunn's Dispensing for Pharmaceutical Students: Ointments, Pastes and Jellies*. 12th Edition, CBS Publishers and Distributors, India, pp 192-210.
23. Odimegwu, D.C., Ibezim, E.C., Esimone, C.O., Nworu, C.S., Okoye, F.B.C., 2008. Wound Healing and Antibacterial Activities of The Extract of *Dissotis Theifolia* (Melastomataceae) Stem Formulated in A Simple Ointment Base. *J Medicinal Plant Res* 2(1):011-016 .
24. Balu Selvakumar, Gokulakrishnan J, Elanchezhian K, Deepa J. Mosquitocidal activities of indian medicinal plant *Pavonia odorata* willd (malvaceae) against selected vector mosquitoes (diptera: culicidae). *Int. J. Curr. Adv. Res*, 2015; 4(7): 221-227.
25. Girish HV, Vinod AB, Dhananjaya BL, Satish Kumar D and Senthil Duraisamy. The Anticancer Potential of *Pavonia odorata* Willd. Extract on Human Breast (MD-MB-231), Prostate (PC-3) and Lung (Calu-6) Cancer cell lines. *Pharmacogn J*, 2016; 8(1): 28-30.
26. Selvan VT, Kakoti BB, Gomathi, P, Ashok Kumar D, Cytotoxic and antitumor activities of *Pavonia odorata* against Erlich's ascities carcinoma cells bearing mice. *Pharmacology Online*, 2007; 2: 453-477.
27. Rayar A, R.Manivannan. Evaluation of Antidiabetic Activity from the Root Extracts of *Pavonia Odorata* Willd., in Alloxan Induced Diabetic Rats. *Int. J. Invent. Pharm. Sci*, 2015; 4(5): 46-52.
28. Seem's nakhare and Garg SC. Antimicrobial activity of the essential oil of *Pavonia odorata* willd. *J. Anc. Sci. Life*, 1992; 12: 227 – 230.
29. Ashish Singhai PK Singour, Garg G, Pawar RS and Patil UK. In Vitro Study on *Pavonia odorata* (Roots) For Anthelmintic Activity. *RJPPD*, 2009; 1(2): 82-84.
30. Hussain MM, Rahman MS, Jabbar A et al. Phytochemical and biological investigations of *Albizia lebbek* Benth. *Bol Latin Car Plant Med Aromat* 7: 273–278, 2008.
31. Pathak N, Gohil P, Patel NB et al. Curative effect of *Albizia lebbek* methanolic extract against adjuvant arthritis-with special reference to bone erosion. *Int J Pharm Sci Drug Res* 1: 183–187, 2009.
32. Pratibha N, Saxena VS, Amit A . Anti-inflammatory activities of Aller-7, a novel polyherbal formulation for allergic rhinitis. *Int J Tissue Res* 26: 43–51, 2004.
33. Saha A, Ahmed M. The analgesic and anti-inflammatory activities of the extract of *Albizia lebbek* in animal model. *Pak J Pharm Sci* 22: 74–77, 2009.
34. Marshall JM. Aloe Vera gel: What is the evidence? *Pharma Jr.* 1990; 24:360–2.
35. Davis RH. *Aloe vera: A scientific approach*. New York: Vantage Press;
36. Tyler V. *The honest herbal: A sensible guide to the use of herbs and related remedies*. 3rd ed. Binghamton, New York: Pharmaceutical Products Press; 1993,
37. Lopez E, Illnait J, Molina V, Oyarzabal A. Effects of D-002 (beeswax alcohols) on lipid peroxidation in middle-aged and older subjects. *Lat Am J Pharm.* 2008; 27: 695-703.
38. Kacaniová M, Vuković N, Chlebo R, I. The antimicrobial activity of honey, bee pollen loads and beeswax from Slovakia. *Arch Biol Sci.* 2012; 64: 927-934. doi:10.2298/ABS1203927K
39. Medically reviewed by Debra Sullivan, Ph.D., MSN, R.N., CNE, COI – By Jenna Fletcher on May 25, 2022





**Shailaja Khedkar and Pallavi M. Chaudhari**

- 40. Malmstrom, Ivar (1949). "Technological aspects of lanolin". Journal of Cosmetic Science. 1 (4). Archived from the original on 4 November 2021. Retrieved 4 November 2021.
- 41. Hoppe, Udo, ed. (1999). The Lanolin Book. Hamburg: Beiersdorf. ISBN 9783931146054.

<p><b>Figure 1:- Signs of Cellulitis</b></p>	<p><b>Figure2:-Drugs and excipients to be used in the formulation of Ointment</b></p>
<p><b>Figure 3:-Hrivera Root</b></p>	<p><b>Figure 4:- Shirish leaves</b></p>
<p><b>Figure 5 :- Alovera Pulp</b></p>	





## Enhancement of Maximum Strength through Low, Moderate and High Intensity Resistance Training Programmes among College Women Athletes

S. Meenakshi<sup>1</sup> and I. John Parthiban<sup>2\*</sup>

<sup>1</sup>Ph.D Research Scholar (Part Time), Department of Physical Education, H. H. The Rajah's College (Autonomous), Pudukkottai, (Affiliated to Bharathidasan University, Tiruchirappalli) Tamil Nadu, India.

<sup>2</sup>Director of Physical Education, H. H. The Rajah's College (Autonomous), Pudukkottai, (Affiliated to Bharathidasan University, Tiruchirappalli) Tamil Nadu, India.

Received: 15 Sep 2023

Revised: 05 Apr 2024

Accepted: 03 May 2024

### \*Address for Correspondence

#### John Parthiban

Director of Physical Education,  
H. H. The Rajah's College (Autonomous), Pudukkottai,  
(Affiliated to Bharathidasan University, Tiruchirappalli)  
Tamil Nadu, India.

Email: drjohnparthiban@gmail.com



This is an Open Access Journal / article distributed under the terms of the **Creative Commons Attribution License** (CC BY-NC-ND 3.0) which permits unrestricted use, distribution, and reproduction in any medium, provided the original work is properly cited. All rights reserved.

### ABSTRACT

Aim of the study was to find out enhancement of maximum strength through low, moderate and high intensity resistance training programmes among college women athletes. For this purpose, sixty (N=60) women athletes who had participated in the inter polytechnic athletic meet during 2021-2022 were randomly selected as subjects. The subjects were divided randomly into four groups of fifteen each (n=15) named Low Intensity Resistance Training(LIRT), Medium Intensity Resistance Training(MIRT), High Intensity Resistance Training (HIRT) and Control. Group-I underwent Low Intensity Resistance Training LIRT), Group-II underwent Medium Intensity Resistance Training(MIRT), Group-III underwent High Intensity Resistance Training (HIRT) and Group-IV acted as Control group(GC). The experimental groups underwent respective training period for three days per week for ten weeks. Maximum strength only selected as dependent variable for this study, and it was measured by 1 RM Dead Lift test. All the subjects were tested before and after the intervention on the selected dependent variable. The data obtained from the experimental groups before and after the experimental period were statistically analyzed with dependent 't'-test and Analysis of covariance (ANCOVA). Whenever the 'F' ratio for adjusted post assessment means was found to be significant, the Scheffe's Post hoc test was applied to determine the paired mean differences. The level of confidence was fixed at 0.05 level for all the cases.



**Meenakshi and John Parthiban**

The Medium Intensity Resistance Training group has been found to be better than the Low Intensity Resistance Training group, High Intensity Resistance Training group, and Control group in developing Maximum Strength.

**Keywords:** Low Intensity Resistance Training (LIRT), Medium Intensity Resistance Training (MIRT), High Intensity Resistance Training (HIRT), Maximum Strength, Analysis of covariance, t-test, High Intensity Resistance Training group and Control group in developing Maximum Strength.

## INTRODUCTION

Sports training is an athletic enhancement procedure that is carried out on the concept of professional principles and that helps athletes to produce awesome and record-breaking athletic success through comprehensive development of mental and physical performance, ability and motivation [1]. This is a technique that gradually increases muscle power by improving the ability to withstand resistance using free weights, machines, or the character's own body weight. Strength training programs are made to impose an increasing number of additional resistances in order to keep up with demand, which in turn encourages the growth of muscle mass. Strength training, when done properly, has been shown to have significant practical benefits that "improve mental in general healthier and well-being, including accelerated bone, muscle, tendon and ligament electricity and durability, improved joint characteristic, reduced potential for injury, increased tip bone density, multiplied metabolism, elevated fitness, [2] improved source cardiac function, and stepped forward lipo-protein lipid profiles, including increased HDL. The core ideas of "strength-training" include "a manipulation of the wide variety of repetitions" (reps), units, pace, sporting activities, and force to aim desired improvements in energy, patience, or length by applying overloading of a group of muscle mass. The particular combinations of reps, units, sporting activities, resistance, and force depend on the purpose for which the exercise is being performed by the character. For example, in order to increase length and strength, more than one (four+) sets with fewer reps must be performed with additional pressure [3].

Normally, dynamometry is used to measure the quality of a muscle by having a subject exert their maximum force (power) against an isokinetic or isometric mechanical switch while using either a single muscle or a group of muscles. Dynamometry is incredibly useful for both clinical and academic research [4]. In different disciplines, the term "training" can mean different things. In sports, "training" is frequently understood to be synonymous with exercising. In a limited sense, preparation involves physical training for improving performance. Building an activity schedule as part of training helps prepare a contestant for a particular event. Similar consideration must be given to these expanding capacity and vitality constraints [5]. An anaerobic activity is resistance training. This exercise regimen can be used to strengthen the body's ability to exert high power outputs and power yields for very short periods of time, which will enable it to carry out repeated bouts of maximal activity. Resistance training refers to exercise that uses a buffer against the loss of a powerful force. Currently, effort is usually put in more effectively working the female rivals. People who are interested in sports requiring speed or power, such as ball, football, or hockey, are aware of this process of energy generation [6].

## METHODOLOGY

Sixty (N=60) female athletes who competed in the inter-polytechnic athletic meet in the 2021–2022 academic year were chosen. A random group sampling test was employed for this study. The chosen participants were divided into four groups of fifteen (n=15), with Group-I receiving low intensity resistance training, Group-II receiving medium intensity resistance training, Group-III receiving high intensity resistance training, and Group-IV serving as the control group. The experimental groups had corresponding training for ten weeks, three days a week. Maximum strength was the only strength-related characteristic chosen as the study's dependent variable, and it was determined using the 1 RM Dead Lift Test [7]. Prior to and shortly following the intervention, all subjects underwent tests to determine their maximum strength.





## ANALYSIS OF THE DATA

Analysis of covariance (ANCOVA) [9] was used to determine differences, if any, among the adjusted posttest means on various criterion variables separately from the data collected from the experimental groups and control group on prior and after experimentation on selected variables. The Scheffe's test was used as a post hoc test whenever they found that the simple effect's *f*-ratio value was significant in order to identify any matched mean differences. The 0.05 level of significance was set in each case. In order to examine the significance differences among Low Intensity Resistance Training group (LIRT), Medium Intensity Resistance Training group (MIRT), High Intensity Resistance Training group (HIRT) and Control group of selected variables dependent *t*-test was applied and it was presented in the Table-1.

The table 1 shows that the maximum strength pre-assessment means for the Low Intensity Resistance Training group (LIRT), Medium Intensity Resistance Training group (MIRT), High Intensity Resistance Training group (HIRT), and Control group, respectively, are 92.53, 92.60, 92.40, and 92.20. The post-assessment means are, in order, 95.67, 95.60, 96.93, and 92.27. Low Intensity Resistance Training Group (LIRT), Medium Intensity Resistance Training Group (MIRT), High Intensity Resistance Training Group (HIRT), and Control Group obtained dependent *t*-ratio values of 8.72, 8.96, 15.01, and 0.14 respectively between the pre and post assessment means on Maximum Strength.

The table value required for significant difference with *df* 14 at 0.05 level is 2.15. It was concluded that Experimental groups such as Low Intensity Resistance Training group (LIRT), Medium Intensity Resistance Training group (MIRT) and High Intensity Resistance Training group (HIRT) had registered significant improvement in Maximum Strength. In order to examine the significance improvement among Low Intensity Resistance Training group (LIRT), Medium Intensity Resistance Training group (MIRT), High Intensity Resistance Training group (HIRT) and Control group of selected variables analysis of covariance (ANCOVA) was applied. Whenever the 'F' ratio for adjusted posttest means was found to be significant, Scheffe's test was followed as a post hoc test to determine which of the paired means difference was significant. The table-2 shows that the pre assessment mean values on Maximum strength of Low Intensity Resistance Training group (LIRT), Medium Intensity Resistance Training group (MIRT), High Intensity Resistance Training group (HIRT) and Control group are 94.40, 94.33, 93.80 and 93.40 respectively. The obtained 'F' ratio of 0.28 for pre assessment scores was lesser than the table value of 2.76 for degrees of freedom 3 and 56 required for significance at 0.05 level of confidence on Maximum strength.

The post assessment mean values on Maximum strength of Low Intensity Resistance Training group (LIRT), Medium Intensity Resistance Training group (MIRT), High Intensity Resistance Training group (HIRT) and Control group are 114.60, 120.80, 110.27 and 94.33 respectively. The obtained 'F' ratio of 98.08 for post- assessment scores was higher than the table value of 2.76 for degrees of freedom 3 and 56 required for significance at 0.05 level of confidence on Maximum Strength. The adjusted post-assessment means on Maximum strength of Low Intensity Resistance Training group (LIRT), Medium Intensity Resistance Training groups (MIRT), High Intensity 114.52, 120.73, 110.30 and 94.44 respectively. The obtained 'F' ratio of 95.90 for adjusted post-assessment scores was higher than the table value of 2.78 for degrees of freedom 3 and 55 required for significance at 0.05 level of confidence on Maximum strength. The results of the study indicate that there are significant differences among the adjusted post assessment means of Low Intensity Resistance Training group (LIRT), Medium Intensity Resistance Training group (MIRT), High Intensity Resistance Training group (HIRT) and Control group in Maximum strength performance. To determine which of the paired means have a significant difference, the Scheffe's test is applied as Post hoc assessment and the results are presented in Table – 3.

Table-3 shows that the adjusted post assessment mean differences on Maximum strength between Low Intensity Resistance Training group and High Intensity Resistance Training group, Low Intensity Resistance Training group and Control group, Medium Intensity Resistance Training group and High Intensity Resistance Training group, Medium Intensity Resistance Training and Control group, High Intensity Resistance Training and Control group are 6.21, 20.08, 10.43, 26.28 and 15.86 respectively, which are greater than the confidence interval value of 4.64



**Meenakshi and John Parthiban**

at 0.05 level of confidence. Further the above shows that the adjusted post assessment mean differences on Maximum strength between Low Intensity Resistance Training group and Medium Intensity Resistance Training group is 4.22, which is less than the confidence interval value of 4.64 at 0.05 level of confidence.

The results of the study showed that there was a significant difference between Low Intensity Resistance Training group and High Intensity Resistance Training group, Low Intensity Resistance Training group and Control group, Medium Intensity Resistance Training group and High Intensity Resistance Training group, Medium Intensity Resistance Training and Control group, High Intensity Resistance Training and Control group on Maximum strength. Further the results of the study showed that there was no significant difference between Low Intensity Resistance Training group and Medium Intensity Resistance Training group on Maximum strength.

The above data also reveal that Medium Intensity Resistance Training group had shown better performance than Low Intensity Resistance Training group, High Intensity Resistance Training group and Control group in Maximum strength. The pre, post and adjusted post assessment mean values of Low Intensity Resistance Training group (LIRT), Medium Intensity Resistance Training group (MIRT), High Intensity Resistance Training group (HIRT) and Control group on Maximum strength are graphically represented in the Figure -1.

**CONCLUSIONS**

The results of the study showed the experimental groups such as Low Intensity Resistance Training group (LIRT), Medium Intensity Resistance Training group (MIRT) and High Intensity Resistance Training group (HIRT) had registered significant improvement on Maximum Strength. Further the study showed, when the experimental groups were compared with each other, the Medium Intensity Resistance Training (MIRT) programme was found to be greater than the Low Intensity Resistance Training (LIRT) programme, High Intensity Resistance Training (HIRT) programme and Control group (CG) on the increase of selected criterion variable namely Maximum Strength.

**REFERENCES**

1. Shamlu Pazare, Neha Tambe, Bhakti Bhadgaonkar, Effect of Pilates exercise on abdominal strength & endurance, girth & skin fold in young women, Indian Journal of Basic and Applied Medical Research; June 2018: Vol.-7, Issue- 3, P. 177-183.
2. Mathiowetz V, Weber K , Volland G , Kashman N, Reliability and validity of grip and pinch strength evaluations. The Journal of Hand Surgery, 1984; 9(2): 222-6.
3. Slentz CA, Houmard JA, Kraus WE. Exercise, abdominal obesity, skeletal muscle, and metabolic risk: evidence for a dose response. Obesity (Silver Spring), 2009 Dec 17, Suppl 3:S27-33.
4. Singh Hardayal, Sports Training, Netaji Subhas National Institute of Sports, Patiala, 1984.
5. Baechle Thomas R, Essential of Straining Training and Conditioning, Champaign Illinois: Human Kinetics Publishers, 1994,p.319.
6. Astrand.PO, K Rodhal. Textbook of work physiology. New York: McGraw-Hill, 1986.Athletes.
7. LeSuer, Dale A., McCormick, James H.; Mayhew, Jerry L. Wasserstein, Ronald L. Arnold, Michael D, The Accuracy of Prediction Equations for Estimating 1-RM Performance in the Bench Press, Squat, and Deadlift. Journal of Strength and Conditioning Research 11(4): p 211-213, November 1997.
8. Markowski, Carol A.; Markowski, Edward P. (1990). "Conditions for the Effectiveness of a Preliminary Test of Variance". The American Statistician, 44 (4): 322–326.
9. Lomax, Richard G. (2007). Statistical Concepts: A Second Course. p. 10. ISBN 978-0-8058-5850-1.





**Meenakshi and John Parthiban**

**Table -1: Distribution Mean values and Dependent t-test values for Pre-Assessment and Post- Assessment on Maximum Strength among Different Groups**

Test	Low Intensity Resistance Training group (LIRT)	Medium Intensity Resistance Training group (MIRT)	High Intensity Resistance Training group (HIRT)	Control group (CG)
Pre-Assessment	92.53	92.60	92.40	92.20
Post-Assessment	95.67	95.60	96.93	92.27
't'-test	8.72*	8.96*	15.01*	0.14

\* Significant at 0.05 level.

(Table value required for significance at .05 level for 't'-test with df 14 is 2.15)

**Table 2: Computation of Analysis of Covariance of Experimental Groups and Control Group on Maximum Strength**

Test	Low Intensity Resistance Training group (LIRT)	Medium Intensity Resistance Training group (MIRT)	High Intensity Resistance Training group (HIRT)	Control group (CG)	Source of Variance	Sum of Squares	df	Mean Squares	F ratio
Pre-Assessment Mean	94.40	94.33	93.80	93.40	Between	10.05	3	3.35	0.28
					Within	678.93	56	12.12	
Post Assessment Mean	114.60	120.80	110.27	94.33	Between	5749.73	3	1916.58	98.08*
					Within	1094.27	56	19.54	
Adjusted Post Assessment Mean	114.52	120.73	110.30	94.44	Between	5595.50	3	1865.17	95.90*
					Within	1069.68	55	19.45	

\* Significant at 0.05 level of confidence (Maximum Strength Scores in Kilograms)

Table value for df (3, 56) at 0.05 level = 2.76 Table value for df (3, 55) at 0.05 level = 2.78

**Table 3: The Scheffe's test for the differences between the adjusted post assessments paired means on Maximum Strength**

Adjusted Post-test Means				Mean Difference	Confidence Interval
Low Intensity Resistance Training group (LIRT)	Medium Intensity Resistance Training group (MIRT)	High Intensity Resistance Training group (HIRT)	Control Group (CG)		
114.52	120.73			6.21*	4.64
114.52		110.30		4.22	4.64
114.52			94.44	20.08*	4.64
	120.73	110.30		10.43*	4.64
	120.73		94.44	26.29*	4.64
		110.30	94.44	15.86*	4.64

\* Significant at 0.05 level of confidence





Meenakshi and John Parthiban

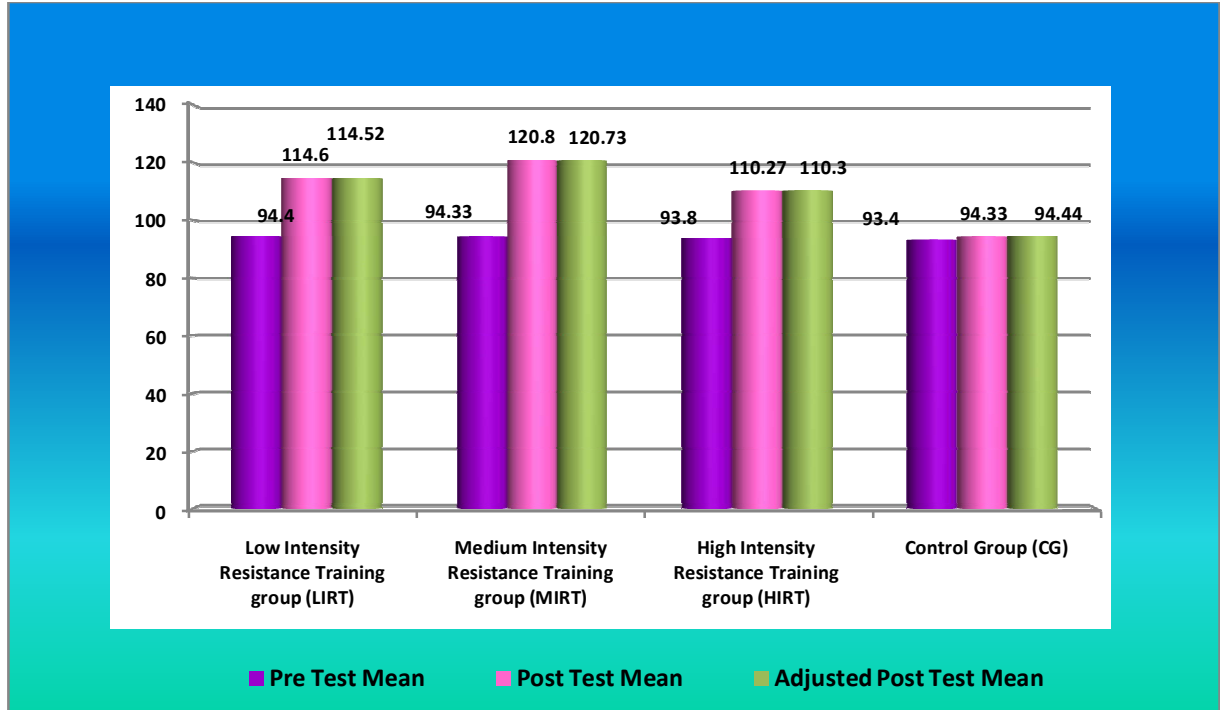


Fig. 1. Pre, Post and Adjusted Post Assessment on Maximum Strength among Different Groups (In Kilograms)







## Investigation of Electrochemical Performance of Cr<sub>2</sub>O<sub>3</sub> Nanoparticles for Supercapacitor Application

R. Cibil<sup>1</sup>, P. N. Selva Kumar<sup>2</sup>, S.Parvin Bavithra<sup>3</sup>, J.Jebasingh Kores<sup>2</sup> and K. Gnanaprakasam Dhinakar<sup>2\*</sup>

<sup>1</sup>Research Scholar (Reg.No. 21112152132004), PG and Research Department of Physics, Pope's College (Autonomous), Sawyerpuram, Tuticorin (Affiliated to Manonmanium Sundaranar University, Abishekapatti, Tirunelveli,) Tamil Nadu, India.

<sup>2</sup>Assistant Professor, PG and Research Department of Physics, Pope's College (Autonomous), Sawyerpuram, Tuticorin (Affiliated to Manonmanium Sundaranar University, Abishekapatti, Tirunelveli,) Tamil Nadu, India.

<sup>3</sup>Research Scholar, PG and Research Department of Physics, Pope's College (Autonomous), Sawyerpuram, Tuticorin (Affiliated to Manonmanium Sundaranar University, Abishekapatti, Tirunelveli,) Tamil Nadu, India.

Received: 22 Jan 2024

Revised: 09 Feb 2024

Accepted: 27 Apr 2024

### \*Address for Correspondence

**K. Gnanaprakasam Dhinakar**

Assistant Professor, PG and Research

Department of Physics, Pope's College (Autonomous),

Sawyerpuram, Tuticorin

(Affiliated to Manonmanium Sundaranar University, Abishekapatti, Tirunelveli,)

Tamil Nadu, India.

Email: kdhinakarr@gmail.com



This is an Open Access Journal / article distributed under the terms of the **Creative Commons Attribution License** (CC BY-NC-ND 3.0) which permits unrestricted use, distribution, and reproduction in any medium, provided the original work is properly cited. All rights reserved.

### ABSTRACT

Chromium oxide nanoparticles were prepared by microwave assisted Solvothermal technique. The precursor materials used include chromium chloride, Urea and an Ethylene glycol (EG) as solvent. From X-ray diffraction (XRD) analysis it is found that the synthesized nanoparticles possess a rhombohedral crystalline Structure with the average particle size of 46nm. The functional group analysis was carried out by FTIR. SEM images reveals that the synthesized particles are Spherical in shape. The bandgap of the Cr<sub>2</sub>O<sub>3</sub> nanoparticles was determined as 2.37eV through Tau plot analysis. The Presence of Chromium and Oxygen in the nanoparticles was confirmed by the Energy Dispersive X- ray Spectroscopy (EDX) Spectrum results. The cyclic voltammogram of the chromium oxide electrode in a 1 M KOH aqueous electrolyte in a three- electrode test system with a various scan rates and the impedance spectra of the chromium oxide electrode over a frequency range of 0.1 Hz to 10 kHz. From the Nyquist plot The diameter of the semicircle is 36.4Ω corresponds to the charge transfer resistance.

**Keywords:** Chromium Oxide, Electrochemical, Solvothermal synthesis, Cyclic Voltammetry.





## INTRODUCTION

Metal oxide nanoparticles have become highly popular in various industries due to their distinct properties. These nanomaterials consisting of metal and oxygen atoms, exhibit unique characteristics at the nanoscale[1-3]. The application of metal oxide nanoparticles is determined by their properties, including shape, crystallinity, conductivity, surface area, size, corrosiveness, photocatalytic activity and Stability[4,5]. Recently, there has been significant interest in nanostructured chromium oxide with evaluated surface areas[6]. The diverse applications span a range of fields, including Solar Cell[7], hydrogen storage[8], catalysts[9], photonics, Li-ion batteries[10] solid oxide fuel cell[11]. Several synthesis techniques have been developed for Cr<sub>2</sub>O<sub>3</sub> nanoparticles, including, bio methods, Nano casting methods, Sol-gel Process and hydrothermal methods[12-17].Cr<sub>2</sub>O<sub>3</sub>exhibits a lower electrical conductivity compared to some other transition metal oxides, but its theoretical capacity is notably high at 1058 mAhg<sup>-1</sup>. As a result, considerable attention has been given to Cr<sub>2</sub>O<sub>3</sub>nanoparticles in the last half-decade. Recent research reveals that nanoscale Cr<sub>2</sub>O<sub>3</sub>displays distinctive features associated with the capacitive nature of charge storage[18]. In this present study, a microwave assisted solvothermal synthesis of nan sized Cr<sub>2</sub>O<sub>3</sub> is described. The phase formation, Size, morphology and electrochemical characteristics of as made Cr<sub>2</sub>O<sub>3</sub> particles are investigated, which will give much valuable information about these materials.

## MATERIALS

Chromium chloride, Urea, and Ethylene glycol (EG) are used as precursors in the synthesis of Cr<sub>2</sub>O<sub>3</sub> nanoparticles.

## Method

The Synthesis of the chromium Oxide was Performed as follows. The precursor of the synthesis are Chromium Chloride and urea we have taken in 1:3 molecular ratio and dissolved in 50ml of Ethylene glycol using a magnetic stirrer. The Obtained clear transparent solution was transferred to a ceramic bowl and placed inside a domestic microwave oven for heating 2 minutes cycles of heating is done until a precipitate was formed at the bottom of the bowl. The precipitate was collected and washed with deionized water for several times then washed with acetone to remove the unwanted organic compounds. The obtained samples are annealed at 450°C for one hour.

## RESULT AND DISCUSSION

### Structural Analysis

#### XRD

X-Ray Diffraction (XRD) Patterns of the Synthesized Samples were Acquired on Bruker-binary V4, X-ray diffractometer system employing monochromatized Cu K $\alpha$  radiation ( $\lambda=1.54056\text{\AA}$ ) source with a scan range of 10° to 80°. Figure 1 shows the XRD Pattern of obtained nanoparticles. The Various angular positions are at 24.49°, 33.58°, 36.18°, 41.46°, 50.19°,54.82° and 65.08° which are indexed to the plane (012), (104), (110), (113), (024), (116) and (300) respectively. The average size of the nanoparticles was estimated from the diffraction peak width using the Scherrer's equation[19]. The average Particle size was found to be 46nm and the nanoparticles are in Rhombohedral structure. All the Peaks in the XRD Patterns are well matched with (JCPDS: 074-0326). The high intensity and sharp diffraction peaks indicate good crystallinity.

#### SEM

SEM measurements were Performed with a ZEISS EVO18 Operating at an acerbated Voltage 0.2 to 30KV. Figure 2 Shows SEM image of Cr<sub>2</sub>O<sub>3</sub> Annealed at 450°C is shown in the figure. The Particles exhibit spherical morphology and are evenly sized, and form agglomerates on the surface Spherical shape formation were aggregated in the form of clusters.





Cibil et al.,

### Optical and Elemental Analysis

#### UV

An Optical absorption study was carried out using UV-Vis-NIR Spectrometer (JASCOV-770). Figure 3 represents a Tauc Plot of  $(\alpha h\nu)^2$  Versus  $h\nu$  of the  $\text{Cr}_2\text{O}_3$  nanoparticles. The energy bandgap of these nanoparticles is estimated using the Tauc relation

$$\alpha h\nu = A (h\nu - E_g)^n$$

Where  $\alpha$  is absorption coefficient,  $h\nu$  is the photon energy,  $E_g$  is the bandgap  $n=1/2$  for the direct transition. The Linear portion of the curve is extrapolated to Energy axis to determine bandgap. Energy bandgap of  $\text{Cr}_2\text{O}_3$  is 2.37 eV [20-22].

#### FTIR

FTIR Spectra were recorded by KBr method in a IRAffinity-1 Spectrometer. Figure 4 shows the FT-IR spectrum of the  $\text{Cr}_2\text{O}_3$  nanoparticles within the range of 400 to 4,000  $\text{cm}^{-1}$  region. The other peaks, at 2,800 to 3,500  $\text{cm}^{-1}$ , arise from OH stretching on the water surface. Broad band at 3132  $\text{cm}^{-1}$  corresponds to the stretching frequency of -OH group. Two sharp peaks displayed at 620  $\text{cm}^{-1}$  and 559  $\text{cm}^{-1}$  attributed to Cr-O bond stretching Modes [23].

#### EDAX

EDAX measurements were performed with a Bruker Nano GmbH at 50 kV, Spot size 25  $\mu\text{m}$ . EDAX was Performed at a resolution of less than 145 eV. Figure 5 shows EDX results it clearly indicate the presence of the elements Cr and O, as the respective Peaks are clearly visible. Moreover, the atomic percentages of Cr and O are 34.67% and 65.33% respectively and demonstrates that the final product is pure chromium (III) oxide.

### Electrochemical Analysis

Figure 6 displays the cyclic voltammogram of the chromium oxide electrode in a 1 M KOH aqueous electrolyte in a three- electrode test system with a scan rate of 200 mV/s. The voltammetric response exhibits characteristic redox peaks, indicative of electrochemical processes occurring at the electrode-electrolyte interface. Two distinct redox peaks are observed in the cyclic voltammogram at potentials, corresponding to the oxidation and reduction processes of chromium oxide [25]. Figure 7 displays the cyclic voltammogram of the chromium oxide electrode in different scan rates from 5 mV/s to 200 mV/s. The peak currents at these potentials provide information about the rate of electron transfer during these electrochemical reactions [26]. Its specific capacitance is up to 300 F/g at the scan rate of 5 mV/s. It still maintains a specific capacitance of 168 F/g even at a high scan rate of 180 mV/s with the steady increasing of sweep rates, the peak intensity becomes strong.

#### EIS

Figure 8 displays the impedance spectra of the chromium oxide electrode in a 1 M KOH solution over a frequency range of 0.1 Hz to 10 kHz. Notably, a prominent semicircle is observed in the high-frequency region, indicative of charge transfer resistance. The diameter of the semicircle is 36.4  $\Omega$  corresponds to the charge transfer resistance, suggesting a notable hindrance to electron transfer at the chromium oxide interface [27]. At lower frequencies, a linear region in the Nyquist plot is indicative of a Warburg impedance, suggesting a diffusion-controlled process. This behavior is consistent with the expected diffusion of ions through the chromium oxide layer [28].

## CONCLUSION

Chromium oxide nanoparticles were synthesized using microwave assisted solvothermal method. XRD confirms that, the synthesized  $\text{Cr}_2\text{O}_3$  nanoparticles are Rhombohedral structure. SEM micrograph of  $\text{Cr}_2\text{O}_3$  annealed at 450°C reveals that the particles are spherical in morphology and are evenly sized. The relative proportions of Cr and O atoms was examined by EDX analysis. The average particle size is 46 nm with rhombohedral structure for the sample. The characteristic vibrational modes of Cr-O were identified in the FT-IR spectrum. The Electrochemical characteristics demonstrate it have good electrode material. Electrochemical impedance spectroscopy on the





Cibil et al.,

chromium oxide electrode revealed valuable information about the charge transfer and diffusion processes. The obtained parameters provide insights into the electrochemical behavior of chromium oxide offering potential applications in Electrochemical Energy storage devices.

## REFERENCE

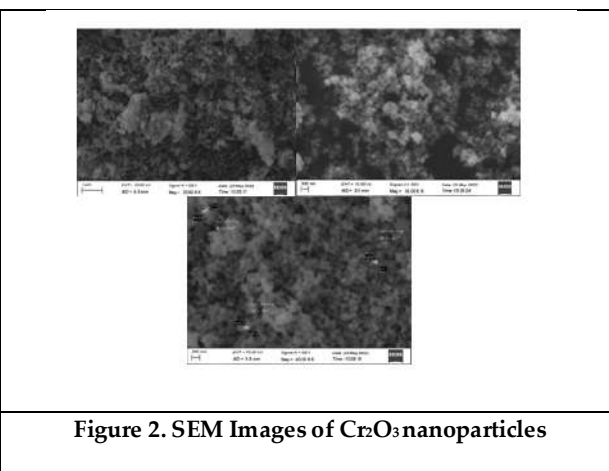
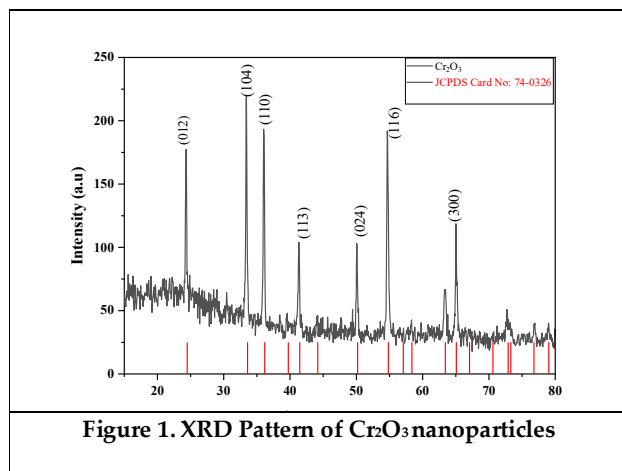
1. Chavali, Murthy S., and Maria P. Nikolova. "Metal oxide nanoparticles and their applications in nanotechnology." *SN applied sciences* 1.6 (2019): 607.
2. Maduraiveeran, Govindhan, ManickamSasidharan, and Wei Jin. "Earth-abundant transition metal and metal oxide nanomaterials: Synthesis and electrochemical applications." *Progress in Materials Science* 106 (2019): 100574.
3. Fernandez-Garcia, M., et al. "Nanostructured oxides in chemistry: characterization and properties." *Chemical reviews* 104.9 (2004): 4063-4104.
4. Akin, Seckin, and SavasSonmezoglu. "Metal oxide nanoparticles as electron transport layer for highly efficient dye-sensitized solar cells." *Emerging materials for energy conversion and storage*. Elsevier, 2018. 39-79.
5. Chen, Xiaobo, and Annabella Selloni. "Introduction: titanium dioxide (TiO<sub>2</sub>) nanomaterials." *Chemical reviews* 114.19 (2014): 9281-9282.
6. Ananda, S., and Netkal M. Made Gowda. "Synthesis of chromium (III) oxide nanoparticles by electrochemical method and MukiaMaderaspatana plant extract, characterization, KMnO<sub>4</sub> decomposition and antibacterial study." *Modern Research in Catalysis* 2.04 (2013): 127.
7. Teixeira, V., et al. "Spectrally selective composite coatings of Cr–Cr<sub>2</sub>O<sub>3</sub> and Mo–Al<sub>2</sub>O<sub>3</sub> for solar energy applications." *Thin solid films* 392.2 (2001): 320-326.
8. Vijay, R., et al. "Hydrogen storage properties of Mg–Cr<sub>2</sub>O<sub>3</sub> nanocomposites: the role of catalyst distribution and grain size." *Journal of alloys and compounds* 424.1-2 (2006): 289-293.
9. Mahmoud, Mohamed E., et al. "Recent advances in adsorptive removal and catalytic reduction of hexavalent chromium by metal–organic frameworks composites." *Journal of Molecular Liquids* 347 (2022): 118274.
10. Fu, Ya, et al. "Chromium (III) oxide carbon nanocomposites lithium-ion battery anodes with enhanced energy conversion performance." *Chemical Engineering Journal* 277 (2015): 186-193.
11. Zhen, Yongda. "Mechanism of Cr deposition and its application in the development of Cr-tolerant cathodes of solid oxide fuel cells." *Solid State Ionics* 179.27-32 (2008): 1459-1464.
12. Kohli, Nipin, Onkar Singh, and Ravi Chand Singh. "Influence of pH on particle size and sensing response of chemically synthesized chromium oxide nanoparticles to alcohols." *Sensors and Actuators B: Chemical* 158.1 (2011): 259-264.
13. Nivethitha, P. Rayani, and D. CarolinJeniba Rachel. "A study of antioxidant and antibacterial activity using honey mediated Chromium oxide nanoparticles and its characterization." *Materials Today: Proceedings* 48 (2022): 276-281.
14. Zhao, Qing, et al. "A cleaner method for preparation of chromium oxide from chromite." *Process Safety and Environmental Protection* 105 (2017): 91-100.
15. Sangeetha, Selvam, et al. "Functional pigments from chromium (III) oxide nanoparticles." *Dyes and Pigments* 94.3 (2012): 548-552.
16. Gibot, Pierre, and Loïc Vidal. "Original synthesis of chromium (III) oxide nanoparticles." *Journal of the European Ceramic Society* 30.4 (2010): 911-915.
17. Devan, Rupesh S., et al. "One-dimensional metal-oxide nanostructures: recent developments in synthesis, characterization, and applications." *Advanced Functional Materials* 22.16 (2012): 3326-3370.
18. Ullah, Shaheed, et al. "A novel Cr<sub>2</sub>O<sub>3</sub>-carbon composite as a high performance pseudo-capacitor electrode material." *ElectrochimicaActa* 171 (2015): 142-149.
19. Bokuniaeva, A. O., and A. S. Vorokh. "Estimation of particle size using the Debye equation and the Scherrer formula for polyphasic TiO<sub>2</sub> powder." *journal of physics: Conference series*. Vol. 1410. No. 1. IOP Publishing, 2019.





## Cibil et al.,

20. Singh, Jarnail, VikramVerma, and Ravi Kumar. "Preparation and structural, optical studies of Al substituted chromium oxide ( $\text{Cr}_2\text{O}_3$ ) nanoparticles." *Vacuum* 159 (2019): 282-286.
21. Anandhi, J. T., S. L. Rayer, and T. Chithambarathanu. "Synthesis, FTIR studies and optical properties of aluminium doped chromium oxide nanoparticles by microwave irradiation at different concentrations." *Chemical and Materials Engineering* 5.2 (2017): 43.
22. Abdullah, Mohammad Margub, et al. "In situ growth and ab initio optical characterizations of amorphous  $\text{Ga}_3\text{Se}_4$  thin film: A new chalcogenide compound semiconductor thin film." *ScriptaMaterialia* 69.5 (2013): 381-384.
23. El-Sheikh, S. M., R. M. Mohamed, and O. A. Fouad. "Synthesis and structure screening of nanostructured chromium oxide powders." *Journal of alloys and compounds* 482.1-2 (2009): 302-307.
24. Aghaie-Khafri, M., and MH KakaieLafidani. "A novel method to synthesize  $\text{Cr}_2\text{O}_3$  nanopowders using EDTA as a chelating agent." *Powder technology* 222 (2012): 152-159.
25. Shafi, Imran, Erjun Liang, and Baojun Li. "Ultrafine chromium oxide ( $\text{Cr}_2\text{O}_3$ ) nanoparticles as a pseudocapacitive electrode material for supercapacitors." *Journal of Alloys and Compounds* 851 (2021): 156046.
26. Li, Tianli, et al. " $\text{Cr}_2\text{O}_3$  nanoparticles: a fascinating electrode material combining both surface-controlled and diffusion-limited redox reactions for aqueous supercapacitors." *Journal of Materials Science* 53.24 (2018): 16458-16465.
27. Asen, Parvin, and Saeed Shahrokhian. "Ternary nanostructures of  $\text{Cr}_2\text{O}_3$ /graphene oxide/conducting polymers for supercapacitor application." *Journal of Electroanalytical Chemistry* 823 (2018): 505-516.
28. Narayanan, Soorya P., et al. "Two-Dimensional Amorphous  $\text{Cr}_2\text{O}_3$  Modified Metallic Electrodes for Hydrogen Evolution Reaction." *physica status solidi (RRL)–Rapid Research Letters* 13.12 (2019): 1900025.

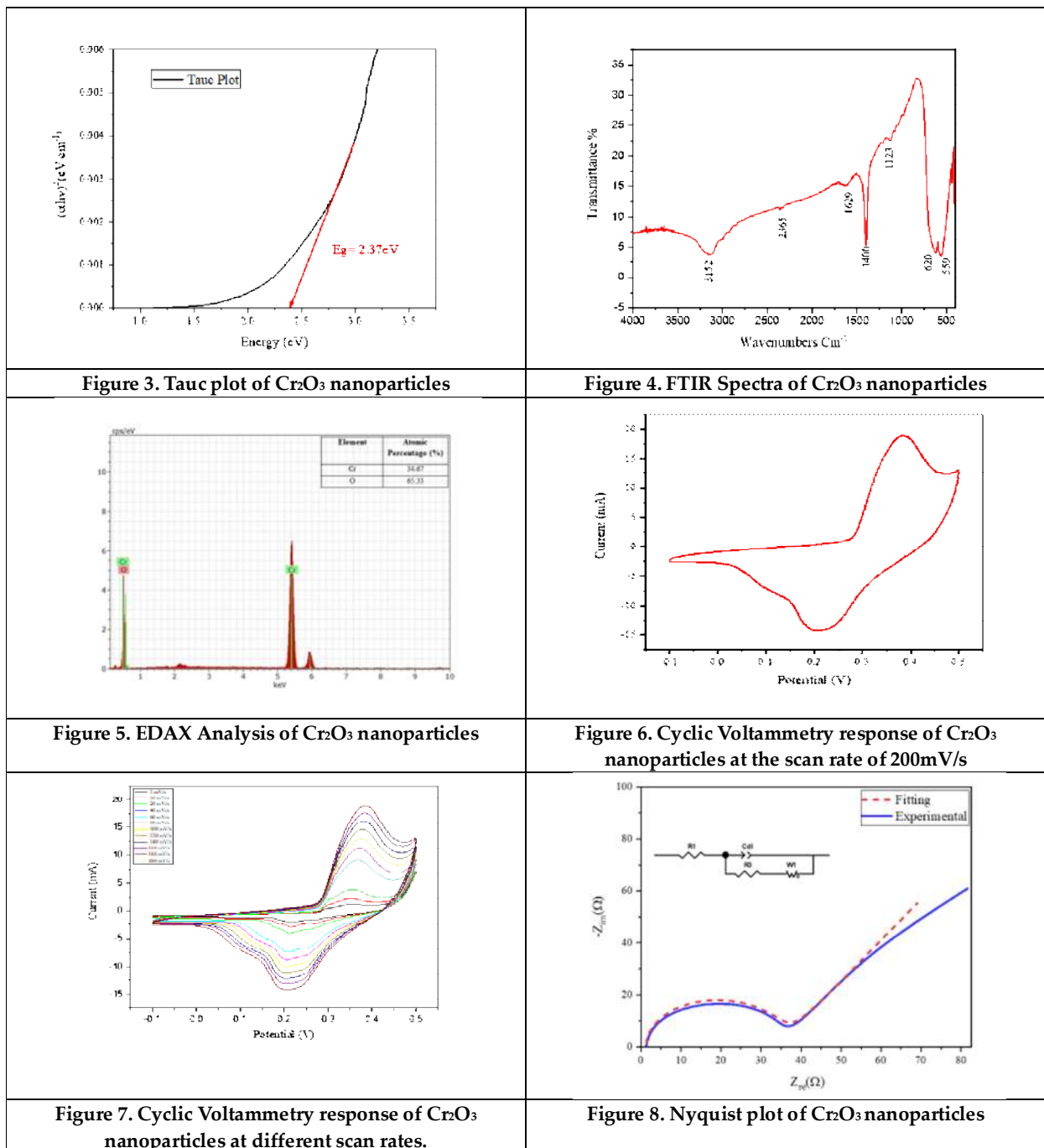


**Figure 2. SEM Images of  $\text{Cr}_2\text{O}_3$  nanoparticles**





Cibil et al.,





## The Future of Deep Learning for Lung Cancer Early Detection and Treatment: A Comprehensive Review

Seema Kashyap<sup>1\*</sup>, Arvind Shukla<sup>2</sup> and Iram Naim<sup>3</sup>

<sup>1</sup>Research Scholar, School of Computer Science and Engineering, IFTM University, Moradabad, Uttar Pradesh, India.

<sup>2</sup>Associate Professor, School of Computer Science and Engineering, IFTM University, Moradabad, Uttar Pradesh, India.

<sup>3</sup>Assistant Professor, Faculty of Engineering and Technology, MJP Rohilkhand University, Bareilly, India.

Received: 12 Jan 2024

Revised: 14 Feb 2024

Accepted: 26 Apr 2024

### \*Address for Correspondence

**Seema Kashyap**

Research Scholar,

School of Computer Science and Engineering,

IFTM University,

Moradabad, Uttar Pradesh, India

Email: seemakashyap2484@gmail.com



This is an Open Access Journal / article distributed under the terms of the **Creative Commons Attribution License** (CC BY-NC-ND 3.0) which permits unrestricted use, distribution, and reproduction in any medium, provided the original work is properly cited. All rights reserved.

### ABSTRACT

A total of 127,070 individuals succumb to lung cancer, with 67,160 being men and 59,910 being women. These statistics illustrate the significance of early detection, prevention, and treatment of lung cancer. Technological advancements are necessary to promptly identify malignant lung cancer due to the rapid proliferation of lung cells. Deep learning models, specially CNNs, have exceptional performance in analyzing lung CT or MRI data to diagnose illnesses. The objective of the study is to examine advanced techniques in deep learning for the early identification of lung cancer within the time frame of 2016 to 2023. Peer-reviewed journal and conference proceedings publications on artificial intelligence (AI), deep learning, and machine learning (ML) techniques are included in the study. The text provides an analysis of deep learning methods, emphasizing their advantages and disadvantages, and proposes potential areas for future research. The study highlights the importance of early detection in the treatment and eradication of lung cancer. The primary focus is on deep learning models, particularly CNNs, and their integration into clinical decision-support systems (CDSSs) inside healthcare organizations. The primary objective is to advance research and devise efficacious models for the identification and treatment of lung cancer. Artificial intelligence (AI) and image processing techniques can be utilized to streamline and enhance the process of detecting cancer.

**Keywords:** Artificial intelligence, Convolutional Neural Network, Diagnostic imaging, Machine Learning, Deep learning,





Seema Kashyap *et al.*,

## INTRODUCTION

Lung cancer is the primary worldwide cause of death and presents challenges in its identification. A plethora of recently found strategies for identifying lung cancer primarily rely on CT scan images, with a subset utilising X-ray imaging. Mortality is a common outcome for both men and women, making it crucial for healthcare providers to promptly and accurately examine nodules. Conventional cancer diagnosis, relying on tissue samples and clinical pathological examination, can be subject to bias and reliant on the expertise of the doctor and the quality of the image. Over the past few years, there has been substantial progress in the field of thoracic imaging, specifically in the area of artificial intelligence. This progress has mostly focused on the detection and diagnosis of thoracic cancer. The utilisation of artificial intelligence, namely in deep learning, has showcased its revolutionary influence in various domains within healthcare settings. Artificial intelligence and image processing have the potential to streamline and enhance the cancer detection process. A range of approaches are employed to identify lung cancer in its early stages. The importance of artificial intelligence has significantly increased in recent years, primarily due to unprecedented advancements in deep learning. Lung cancer can originate in the lungs, bronchi, or nasal passages. small-cell lung cancer and non-small-cell lung cancer are the primary manifestations of this ailment.

Smoking is highly correlated with a higher incidence of aggressive small cell lung cancer , but non-small cell lung cancer is more common and progresses at a slower rate. The application of artificial intelligence, specifically deep learning, is becoming more and more common in the field of early lung cancer diagnosis. Deep learning algorithms are employed to analyze CT scans and X-ray pictures. When compared to low-dose CT scans, chest X-rays are a more cost-effective and accessible option, while also posing a lower risk of radiation exposure. CT scans are considered superior for achieving precise outcomes. The marker-controlled watershed segmentation technique is widely recognized for its capacity to produce precise results in the detection of lung cancer. Various classifier approaches and segmentation techniques are employed in combination to identify photos. Deep learning technologies surpass ordinary machine learning techniques in terms of accuracy. Big data, cloud computing, the Internet of Things (IoT), and artificial intelligence (AI) are transforming the medical industry. Cloud platforms and AI enable clinicians to receive continuous advice by analyzing patient data, facilitating the prompt detection of potential difficulties. Early detection, proactive interventions, and efficacious treatment are crucial in treating lung cancer. The categorization of lung cancer has undergone changes as a result of advancements in molecular biology and genetics. Lung cancer poses a significant threat to global health, causing millions of deaths annually. Non-small cell lung cancer is the more common and less severe of the two main types, while small cell lung cancer is more severe. Lung nodules, whether malignant or benign, are abnormal growths that necessitate early detection for effective treatment. The comprehensive review provides a thorough examination of the achievements, challenges, and methodologies associated with the early detection and management of lung cancer. Furthermore, it emphasizes the crucial significance of artificial intelligence and deep learning in enhancing the precision and effectiveness of medical diagnostics.

## LITERATURE REVIEW

This section is a comprehensive review of deep learning approaches used for the detection of lung tumours. The main objective of the research is to provide a thorough analysis of several deep learning techniques, imaging methodologies, and performance metrics by combining numerous existing approaches. Furthermore, the objective of identifying research gaps is to stimulate subsequent inquiry and improve the development of more effective models for the timely identification of lung cancer. VR, N. et al.'s[1] computerized ExtRanFS detects lung cancer malignancy using transfer learning and an Extremely Randomized Tree Classifier. With 99.09% accuracy, 98.33% sensitivity, and 98.33% F1-Score, the suggested technique performed well. This shows its excellent accuracy in detecting malignant lung cancer. Fatoki, F. M. et al. [2] developed a computational model for lung cancer prediction using machine learning. Various algorithms were evaluated, with Support Vector Machine (SVM) proving to be the most effective,





**Seema Kashyap et al.,**

indicating its potential for real-world lung cancer prediction. Bhardwaj et al. [3] employed a fusion of Convolutional Neural Networks (CNNs) and Region-based Convolutional Neural Networks (R-CNN) to automate the process of mapping lung areas and categorising tissues in CT images. The approach demonstrated exceptional accuracy and sensitivity, indicating its potential for enhancing precision in medical diagnostics and lung image processing. Parveen, R. et al. [4] developed a computer-aided diagnosis model utilising a modified Xception deep neural network to classify images in lung and kidney CT scans into many classes. The model demonstrated exceptional performance in classifying lung cancer across several categories, achieving an accuracy of 99.39%, precision of 99.33%, recall of 98%, and an F1-score of 98.67%. Bhattacharjee, A. et al. [5] achieved better results in lung nodule identification by using a finely adjusted ResU-Net model. Their technique achieved an F1-score of 97.44%, an intersection over union score of 95.02%, and a dice score of 94.87%. They used 1224 CT patient pictures with diverse nodule morphologies and sizes. The binary cross-entropy loss was 0.34%, whereas the dice coefficient and binary focal loss were 0.7585. Ananthakrishnan, B. et al. [6] suggested AdenoCanNet model outperforms known models, obtaining a testing accuracy of 98.77% in situations including lung classes. M. A. Talukder et al. [7] extracted picture attributes using CNN architectures (VGG16, VGG19, DenseNet169, DenseNet201). These characteristics were then given into six Machine Learning (ML) algorithms for cancer detection (XGB, RF, SVM, LGB, MLP, LR).

SVM, Logistic Regression, and MLP emerged as the most accurate classifiers. Gupta, S., et al. [8] used CNNs that had already been trained to diagnose colon cancer (CRC). They improved designs such as RESNET50, INCEPTIONV3, VGG16, VGG19, and RESNET152V2. INCEPTIONV3 performed the best, with an 89.8% average accuracy in recognising eight CRC classifications, demonstrating the efficiency of deep learning and hyper parameter optimisation in improving cancer detection accuracy. Yu, H. et al. [12] presents the "Adaptive Hierarchical Heuristic Mathematical Model (AHHMM)" as a method for identifying lung cancer. The suggested method consists of many processes, which include capturing images, preprocessing, converting to binary format, setting a threshold, dividing into segments, extracting features, and utilising a deep neural network (DNN) for detection. Based on the test findings, the proposed model showed a high accuracy rate, accurately predicting the presence or absence of lung cancer with 96.67% precision. Nasser, I. M. et al. [18] devised an Artificial Neural Network (ANN) comprising of four basic layers to identify lung cancer cells. The approach attained a precision of 96.67% in the lung cancer dataset survey, showcasing the efficacy of the network in detecting lung cancer. Teramoto et al. [34] introduced the use of a "Deep Convolutional Neural Network (DCNN)" to automatically classify lung cancer. Seventy-six photos of cancer cells were used to test the approach, and seventy-one percent of the images had correct categorization. The DCNN design comprises of three convolutional layers, two fully linked layers, and three pooling layers.

Ozdemir O. et al. [29] introduced a low-dose CT scanning apparatus designed for the diagnosis of lung cancer. This equipment utilises three-dimensional convolutional neural networks. The algorithm attained a precision rate of 96.5% in detecting lung cancer by using data from Kaggle, LUNA-16, and LIDC-IDRI. Zhang, Q. et al. [13] proposed the "Multi-Scene Deep Learning Framework (MSDLF)" which incorporates a "vesselness filter" to enhance precision and minimise incorrect identifications while detecting large lung nodes (>3 mm). Data setup, lung contour correction, tissue segmentation, vascular removal, dataset standardisation, and a four-channel CNN model for segmentation and classification using the LIDC-IDRI dataset are used. Masood et al. [16] presented 3D Deep Convolutional Neural Networks (3DDCNN) to radiologists, which integrate deep learning and cloud computing to accurately detect lung nodules. The method, which used the Multi-Region Proposal Network (mRPN), was 98.5% successful at finding lung cancer using data from ANODE09, LUNA-16, LIDC-IDRI, and SHANGHAI Hospital. Guo et al. [17] presented the Knowledge-based Analysis of Mortality Prediction Network (KAMP-Net), which use data augmentation to train convolutional neural networks. Combining CNN and SVM results to figure out death risk using the National Lung Screening Trial (NLST) dataset, the method does a 28.1% better job than doctors (AUC = 0.82). The approach encompasses Multi-Channel Image Coding, Network Design and Implementation, Integration of Deep Learning, and Clinical Knowledge. Pang et al. [19] used picture preparation methods and DenseNet to sort lung cancer images into different categories. To mitigate the issue of insufficient data, they employed techniques such as rotation, translation, and transformation. The AdaBoost algorithm was employed to combine several categorization outcomes. The model, evaluated using the Shandong Provincial Hospital dataset, attained an accuracy



**Seema Kashyap et al.,**

of 89.85% in the identification of lung cancer. Ibrahim, D. M. et al. [9] conducted a comparative analysis of four different designs for the categorization of chest x-rays and CT images. The VGG19+CNN model had superior performance compared to other models, obtaining an AUC of 99.66% and a success rate of 98.05%. Additionally, it exhibited high values for recall, precision, specificity, negative predictive value, F1 score, and Matthew's correlation coefficient. Zhang G et al. [12] introduced a model that utilises a DenseNet-based architecture with 3D filters and pooling kernels. This model achieved an accuracy rate for classification of 92.4% on the LUNA16 dataset. L. Liu et al. [20] introduced MTMR-Net as a method for detecting lung nodules, obtaining an accuracy of 93.5%. The model surpasses existing techniques in terms of accuracy, sensitivity, and specificity by adding Multi-Task Learning and Margin Ranking Loss in its architecture. Lin, C. J. et al. [14] propose the use of a two-dimensional convolutional neural network (CNN) with Taguchi parametric optimisation to automatically identify lung cancer in CT images. The Taguchi method makes the CNN system more accurate, making it better than the original AlexNet. Cai, L. et al. [15] used a Mask R-CNN and volume rendering for 3D lung nodule segmentation. Three-dimensional reconstruction, detection and segmentation, and pre-processing modules are all included in the model. The model was tested on the LUNA-16 and Ali TianChi datasets and was 88.7% accurate at finding lung cancer. Y. Xie et al. [30] suggest a multi-view knowledge-based collaborative (MV-KBC) deep model for telling the difference between cancerous and noncancerous lung tumours with limited chest CT data. The model, evaluated using the LIDC-IDRI dataset, attains a lung cancer diagnosis accuracy of 91.60 per cent. Li et al. [22] proposed a deep-learning method for analysing thoracic MR images.

Their system utilises a CT nodule identification strategy that works on the complete picture without the need for candidate extraction. The more rapid R-CNN model had a sensitivity of 85.2% in accurately detecting lung cancer. W. Chen et al. [23] introduced a "hybrid segmentation network (HSN)" based on a convolutional neural network (CNN) for tumour segmentation. Using 3D and 2D CNNs along with a mixed features fusion module, the method got a mean accuracy of 0.909 and a mean sensitivity of 0.872 on the data set from Shandong University Hospital. Lakshmanaprabu S.K. et al. [24] introduced the Optimal Deep Neural Network (ODNN) approach for identifying lung CT images. By applying Linear Discriminant Analysis (LDA) to reduce dimensionality and subsequently enhancing it with the Modified Gravitational Search Algorithm (MGSA), the classifier attained the following results: 94.56% accuracy, 94.2% specificity, and 96.2 % sensitivity. Zhang et al. [20] introduced a three-dimensional Convolutional Neural Network (CNN) to detect and categorise lung nodules from CT images. With datasets from Guangdong Provincial People's Hospital, Kaggle, and LUNA-16, the algorithm outperformed manual evaluation with 84.4% sensitivity. Zhang C et al. [25] utilised publicly available imaging data to train a Convolutional Neural Network (CNN) model to detect lung nodules. The model achieved a sensitivity of 84.4% and a specificity of 83.0%. The algorithm showed efficacy in decreasing false-positive and false-negative results, and it detected tiny nodules (less than 10 mm) just as well as bigger ones (10–30 mm). G. Jakimovski et al. [26] used a double convolutional Deep Neural Network (CDNN) and a conventional CDNN to classify lung nodules from CT images.

The dual CDNN attained a precision of 0.909, whereas the conventional CDNN obtained 0.872 in the conducted trials. Jun Wang et al. [27] suggested a unique CAD solution for lung nodule diagnosis based on three neural networks. The method identified candidates quickly from chest volume CT scans with few false negatives and positives. Area classification, region proposal, and feature extraction networks were evaluated using Siemens, General Electric, TIANCHI AI, LUNA-16, LIDC-IDRI, and INDEPENDENT datasets. The trials proved the lung cancer screening strategy worked. C. Wang et al. [28] categorised lung pictures using "inception-v3" transfer learning. They added pulmonary imaging data, modified the Inception-v3 model for automated feature extraction, and classified images using Softmax, Logistic, and SVM classifiers. Among DCNN-based models, the experiments had a maximum sensitivity of 95.41 and specificity of 80.09. H. Jiang et al. [33] developed "four-channel convolution neural networks (CNN)" and two-image training with the LIDC-IDRI dataset to detect lung nodules. The technique has 80.06% lung cancer sensitivity with 4.7 false positives per scan and 94% with 15.1 false positives. The approach uses a "multigroup patch-based learning system" to decrease false positives and improve lung nodule detection in huge visual data sets. Y. Liu et al. [31] introduced DenseBTNet, a convolutional network for lung nodule classification, which outperformed state-of-the-art approaches on the LIDC-IDRI dataset! DenseBTNet showed



**Seema Kashyap et al.,**

superior capacity to acquire more precise and condensed models in comparison to DenseNet. Jin, H. et al. [32] constructed a deep three-dimensional residual convolutional neural network (CNN) with the purpose of minimizing the occurrence of false-positive nodules. This CNN was trained using the LUNA16 Challenge dataset. The approach exhibited excellent detection capabilities, with a sensitivity of 98.3% as indicated by the free-response receiver operating characteristic (FROC) curve. Q. Dou et al. [35] developed a 3-D CNNs-based framework to reduce CT scan lung nodule detection false positives. 3-D CNNs with 3-D convolutions and max-poolings analyse huge medical pictures better than 2-D CNNs. In the LUNA16 Challenge, multilayer contextual networks reduced false positives with 94.4% sensitivity.

**RESEARCH GAPS**

The cumulative efforts of the algorithms that were outlined earlier to revolutionise lung cancer diagnosis via the use of artificial intelligence (AI) and deep learning methods are the source of the scientific reason and significance of Many different methods are included in the algorithms. Some of these methods include adaptive mathematical models, neural networks, convolutional neural networks (CNN), low-dose CT scanning devices, and multi-view knowledge-based collaborative models. Several algorithms displayed excellent detection rates, which ranged from 71% to 98.5%, which highlighted the promise of artificial intelligence in generating accurate and dependable results in lung cancer diagnosis.

**Utilisation of the Data**

To demonstrate the significance of using extensive datasets for training and testing models, these methods make use of a variety of datasets, including LIDC-IDRI, Kaggle, TIANCHI AI, and others. Multiple methods have been devised to mitigate the occurrence of false positives, a prevalent challenge in the detection of lung cancer. Margin ranking loss, multi-task learning, and vesselness filters are a few techniques that improve precision.

**Early Detection and Integration with the Cloud**

The emphasis on early detection is critical, as evidenced by the combination of cloud computing, big data, and AI. Continuous monitoring, data analysis, and the provision of timely advice to healthcare experts are all made possible as a result of this. Examples of methods that integrate many imaging modalities include three-dimensional convolutional neural networks (3DCNN) for computed tomography (CT) scans, magnetic resonance (MR) pictures, and multi-view knowledge-based collaborative models. This technique, which utilises many modalities, expands the range of possibilities for lung cancer diagnosis.

**Strategies for Optimum Extraction:**

Optimisation techniques like Taguchi parametric optimisation, transfer learning, and hybrid segmentation networks highlight the importance of employing optimisation tactics to enhance the efficiency of deep learning models. Studies indicate that novel algorithms surpass the existing methods in terms of accuracy, sensitivity, and specificity when compared to current procedures. KAMP-Net and other algorithms explore the capabilities of artificial intelligence in both cancer detection and mortality risk prediction. This comprehensive strategy can enhance the ability of healthcare practitioners to make more informed choices.

**Implementation with Regard to Various Image Types:**

The capacity of algorithms to function with a wide variety of picture types, such as chest radiographs, CT scans, and MR images, demonstrates their applicability to a variety of clinical circumstances. It has been suggested via preliminary research and proof-of-concept results that these algorithms have the potential to be utilised in clinical settings, where they might be of assistance to radiologists and other medical professionals in making an accurate and timely diagnosis. In conclusion, the scientific justification for these algorithms resides in the fact that they have the potential to revolutionise the identification of lung cancer by enhancing accuracy, decreasing the number of false





**Seema Kashyap et al.,**

positives, and contributing to the facilitation of early detection. It looks like early studies are showing positive results, which could mean a big change in how AI is used to improve lung cancer care.

### Evaluation Criteria

The model's precision, accuracy, recall, F1-score metrics, and confusion matrix are assessed.

#### Accuracy

Accuracy quantifies model predictions' overall accuracy.

$$Accuracy = \sum_c \frac{TP_c + TN_c}{TP_c + FP_c + TN_c + FN_c}, c \in \text{classes}$$

#### Precision

Precision quantifies the percentage of malignant lung pictures properly classified.

$$Precision = \sum_c \frac{TP_c}{TP_c + FP_c}, c \in \text{classes}$$

#### Recall

The percentage of malignant lung pictures accurately classified is called recall

$$Recall = \sum_c \frac{TP_c}{TP_c + FN_c}, c \in \text{classes}$$

#### F1-score

By integrating recall and precision, the F1 score balances both. The harmonic mean of precision and recall.

$$F1_{score} = 2 * \frac{\text{precision} * \text{sensitivity}}{\text{precision} + \text{sensitivity}}$$

### Confusion Matrix

The evaluation of a classification model can be assessed using a tabular representation known as the confusion matrix. The display indicates the number of accurate positive (TP), accurate negative (T.N.), inaccurate positive (F.P.), and inaccurate negative (FN) forecasts.

TP: True Positive: Correctly identified images of a malignant lung

TN: True Negative: Imaging of a normal lung is reliably identified as such.

FP: False Positive: Normal lung images are incorrectly classified as cancerous lung.

FN: False Negative: Images of cancerous lungs falsely identified as healthy lungs

Through the computation of these metrics and examination of the confusion matrix, we can evaluate the efficacy of the constructed model in relation to its accuracy, precision in correctly categorising cancerous lung images, recall in detecting cancerous lung images, and the equilibrium between precision and recall as measured by the F1-score.

## CONCLUSION AND FURTHER INVESTIGATION

The research offers an extensive examination of deep learning methodologies employed in the identification of lung cancer, covering pertinent literature published from 2016 to 2023. The review synthesises established approaches in machine learning, deep learning, and artificial intelligence through an analysis of peer-reviewed journal papers and conference proceedings. The study provides significant insights regarding the merits and drawbacks of several deep learning approaches. indicates areas where further research is needed, and proposes prospective avenues for future investigations. The study focuses on the importance of clinical decision-making systems in healthcare and attempts to provide essential knowledge that might stimulate additional research and fill gaps in the field. In summary, the



**Seema Kashyap et al.,**

systematic review functions as a valuable tool for researchers and readers, providing a thorough summary and establishing the foundation for future progress in the diagnosis of lung cancer.

## REFERENCES

1. VR, N., & Chandra SS, V. (2023). ExtRanFS: An Automated Lung Cancer Malignancy Detection System Using Extremely Randomized Feature Selector. *Diagnostics*, 13(13), 2206.
2. Fatoki, F. M., Akinyemi, E. K., & Philips, S. A. (2023). Prediction of Lungs Cancer Diseases Datasets Using Machine Learning Algorithms. *Current Journal of Applied Science and Technology*, 42(11), 15-23.
3. Bhardwaj, S., Siddiqui, E. A., Chaurasia, V., Shandilya, M., Patankar, M., & Kumar, A. (2023, March). Detection And Classification of Lung Cancer CT Images Using Mask R-CNN Based Generated Mask Method. In *2023 1st International Conference on Innovations in High-Speed Communication and Signal Processing (IHCSF)* (pp. 497-501). IEEE.
4. Parveen, R., Saleem, U., Abid, K., & Aslam, N. (2023). Identification of Lungs Cancer by using Watershed Machine Learning Algorithm.
5. Bhattacharjee, A., Murugan, R., Goel, T., & Mirjalili, S. (2023). Pulmonary Nodule Segmentation Framework Based on Fine-Tuned and Pretrained Deep Neural Network Using CT Images. *IEEE Transactions on Radiation and Plasma Medical Sciences*, 7(4), 394-409.
6. Ananthkrishnan, B., Shaik, A., Chakrabarti, S., Shukla, V., Paul, D., & Kavitha, M. S. (2023). Smart Diagnosis of Adenocarcinoma Using Convolution Neural Networks and Support Vector Machines. *Sustainability*, 15(2), 1399.
7. Talukder, M. A., Islam, M. M., Uddin, M. A., Akhter, A., Hasan, K. F., & Moni, M. A. (2022). Machine learning-based lung and colon cancer detection using deep feature extraction and ensemble learning. *Expert Systems with Applications*, 205, 117695.
8. Gupta, S., Gupta, A., Kumar, A., Gupta, S., & Singh, A. (2022, November). Multi-class classification of colorectal cancer tissues using pre-trained CNN models. In *TENCON 2022-2022 IEEE Region 10 Conference (TENCON)* (pp. 1-6). IEEE.
9. Ibrahim, D. M., Elshennawy, N. M., & Sarhan, A. M. (2021). Deep-chest: multi-classification deep learning model for diagnosing COVID-19, pneumonia, and lung cancer chest diseases. *Computers in biology and medicine*, p. 132, 104348.
10. Cherukuri, N., Bethapudi, N. R., Thotakura, V. S. K., Chitturi, P., Basha, C. Z., & Mummidi, R. M. (2021, March). Deep learning for lung cancer prediction using nscls patients ct information. In *2021 International Conference on Artificial Intelligence and Smart Systems (ICAIS)* (pp. 325-330). IEEE.
11. Zhang, G., Lin, L., & Wang, J. (2021, March). Lung nodule classification in CT images using 3D densenet. In *Journal of Physics: Conference Series* (Vol. 1827, No. 1, p. 012155). IOP Publishing.
12. Yu, H., Zhou, Z., & Wang, Q. (2020). Deep learning assisted predict of lung cancer on computed tomography images using the adaptive hierarchical heuristic mathematical model. *IEEE Access*, p. 8, 86400–86410.
13. Zhang, Q., & Kong, X. (2020). Design of automatic lung nodule detection system based on multi-scene deep learning framework. *IEEE Access*, p. 8, 90380–90389.
14. Lin, C. J., Jeng, S. Y., & Chen, M. K. (2020). Using 2D CNN with Taguchi parametric optimization for lung cancer recognition from CT images. *Applied Sciences*, 10(7), 2591.
15. Cai, L., Long, T., Dai, Y., & Huang, Y. (2020). Mask R-CNN-based detection and segmentation for pulmonary nodule 3D visualization diagnosis. *Ieee Access*, 8, 44400-44409.
16. Masood, A., Yang, P., Sheng, B., Li, H., Li, P., Qin, J., ... & Feng, D. D. (2019). Cloud-based automated clinical decision support system for detection and diagnosis of lung cancer in chest CT. *IEEE journal of translational engineering in health and medicine*, 8, 1-13.
17. Guo, H., Kruger, U., Wang, G., Kalra, M. K., & Yan, P. (2019). Knowledge-based analysis for mortality prediction from CT images. *IEEE Journal of biomedical and health informatics*, 24(2), 457-464.





## Seema Kashyap et al.,

18. Nasser, I. M., & Abu-Naser, S. S. (2019). Lung cancer detection using artificial neural network. *International Journal of Engineering and Information Systems (IJEAIS)*, 3(3), 17-23.
19. Pang, S., Zhang, Y., Ding, M., Wang, X., & Xie, X. (2019). A deep model for lung cancer type identification by densely connected convolutional networks and adaptive boosting. *IEEE Access*, 8, 4799–4805.
20. Liu, L., Dou, Q., Chen, H., Qin, J., & Heng, P. A. (2019). Multi-task deep model with margin ranking loss for lung nodule analysis. *IEEE transactions on medical imaging*, 39(3), 718–728.
21. Shakeel, P. M., Burhanuddin, M. A., & Desa, M. I. (2019). Lung cancer detection from CT image using improved profuse clustering and deep learning instantaneously trained neural networks. *Measurement*, 145, 702-712.
22. Li, Y., Zhang, L., Chen, H., & Yang, N. (2019). Lung nodule detection with deep learning in 3D thoracic MR images. *IEEE Access*, 7, 37822-37832.
23. Chen, W., Wei, H., Peng, S., Sun, J., Qiao, X., & Liu, B. (2019). HSN: hybrid segmentation network for small cell lung cancer segmentation. *IEEE Access*, 7, 75591-75603.
24. Lakshmanaprabu, S. K., Mohanty, S. N., Shankar, K., Arunkumar, N., & Ramirez, G. (2019). Optimal deep learning model for classification of lung cancer on CT images. *Future Generation Computer Systems*, 92, 374–382.
25. Zhang, C., Sun, X., Dang, K., Li, K., Guo, X. W., Chang, J., ... & Zhong, W. Z. (2019). Toward an expert level of lung cancer detection and classification using a deep convolutional neural network. *The oncologist*, 24(9), 1159–1165.
26. Jakimovski, G., & Davcev, D. (2019). Using double convolution neural network for lung cancer stage detection. *Applied Sciences*, 9(3), 427.
27. Wang, J., Wang, J., Wen, Y., Lu, H., Niu, T., Pan, J., & Qian, D. (2019). Pulmonary nodule detection in volumetric chest CT scans using CNNs-based nodule-size-adaptive detection and classification. *IEEE Access*, 7, 46033-46044.
28. Wang, C., Chen, D., Hao, L., Liu, X., Zeng, Y., Chen, J., & Zhang, G. (2019). Pulmonary image classification based on inception-v3 transfer learning model. *IEEE Access*, 7, 146533-146541.
29. Ozdemir, O., Russell, R. L., & Berlin, A. A. (2019). A 3D probabilistic deep learning system for detection and diagnosis of lung cancer using low-dose CT scans. *IEEE transactions on medical imaging*, 39(5), 1419-1429.
30. Xie, Y., Xia, Y., Zhang, J., Song, Y., Feng, D., Fulham, M., & Cai, W. (2018). Knowledge-based collaborative deep learning for benign-malignant lung nodule classification on chest CT. *IEEE transactions on medical imaging*, 38(4), 991–1004.
31. Liu, Y., Hao, P., Zhang, P., Xu, X., Wu, J., & Chen, W. (2018). Dense convolutional binary-tree networks for lung nodule classification. *IEEE Access*, 6, 49080-49088.
32. Jin, H., Li, Z., Tong, R., & Lin, L. (2018). A deep 3D residual CNN for false-positive reduction in pulmonary nodule detection. *Medical Physics*, 45(5), 2097-2107.
33. Jiang, H., Ma, H., Qian, W., Gao, M., & Li, Y. (2017). An automatic detection system of lung nodule based on multigroup patch-based deep learning network. *IEEE journal of biomedical and health informatics*, 22(4), 1227–1237.
34. Teramoto, A., Tsukamoto, T., Kiriya, Y., & Fujita, H. (2017). Automated classification of lung cancer types from cytological images using deep convolutional neural networks. *BioMed research international*, 2017.
35. Dou, Q., Chen, H., Yu, L., Qin, J., & Heng, P. A. (2016). Multilevel contextual 3-D CNNs for false-positive reduction in pulmonary nodule detection. *IEEE Transactions on Biomedical Engineering*, 64(7), 1558–1567.
36. Krishnaiah, V., Narsimha, G., & Chandra, D. N. S. (2013). Diagnosis of lung cancer prediction system using data mining classification techniques. *International Journal of Computer Science and Information Technologies*, 4(1), 39–45.





Seema Kashyap et al.,

Table 1: Comparing contemporary lung cancer detection methods

Year	Author	Data set	Method Used	Performance criteria
2023	VR, N. et al.[1]	IQ-OTH/NCCD (CT image)	computerised ExtRanFS	99.09% accuracy, 98.33% sensitivity,
2023	Fatoki, F. M. et al. [2]	LungCT image	CNN+SVM	accuracy, sensitivity, and specificity,
2023	Bhardwaj et al. [3]	Lung CT image	CNN+R-CNN	oaccuracy, sensitivity, and specificity,
2023	Parveen, R. et al. [4]	Lung CT image	Xception deep neural networks	accuracy 99.39%, precision99.33%, recall 98%, and an F1-score 98.67%.
2023	Bhattacharjee, A. et al. [5]	Lung CT image	finely adjusted ResiU-Net model.	F1-score 97.44%, dice score 94.87%.
2023	Ananthkrishnan, B. et al. [6]	LC25000 Lung histopathological image data	AdenoCanNet model	Testing accuracy 98.77%
2022	M. A. Talukder et al. [7]	LC25000 Lung histopathological image data	CNN architectures + machine learning classifiers	accuracy
2022	Gupta, S., et al. [8]	LC25000 Lung histopathological image data	deep learning models and hyperparameter optimization	Accuracy 89.9%
2021	Ibrahim, D. M. et al. [9]	chest X-ray and (CT) image	VGG19-CNN,	Accuracy-98.05,Recall-98.05%,Precision-98.43%,specificity-99.5%, F1 score-98.24, MCC-97.7%, and AUC-99.66%,
2021	Cherukuri, N. et al. [10]	CT IMAGES	3DCNN	Meta p-value test t
2021	Zhang Get al. [11]	LIDC-IDRI, LUNA-16	3D DenseNet, Dense block,	Accuracy-92.04, Sensitivity-87.0%, Specificity-96.0%,
2020	Yu, H. et al. [12]	<a href="http://diagnijmegen.nl/index.php/LungCancer">http://diagnijmegen.nl/index.php/Lung Cancer</a>	AHHMM	Accuracy-96.67%
2020	Q. Zhang et al. [13]	LIDC-IDRI	MSDLF by the vesselness filter	Accuracy-98.7%
2020	Lin, C. J. et al. [14]	LIDC-NCI	Taguchi-based CNN	Accuracy-99.6%
2020	Cai, L. et al. [15]	LUNA-16, Ali TianChi challenge	Mask R-CNN	sensitivities of 88.1% at 1 false positive per scan
2020	A. Masood et al. [16]	ANODE09, LUNA-16, LIDC-IDRI, SHANGHAI Hospital	3DDCNN	sensitivity -98.7% at 1.97 FPs per scan
2020	Guo, H. et al. [17]	(NLST)	(KAMP-Net)	The AUC-0.82 with the





## Seema Kashyap et al.,

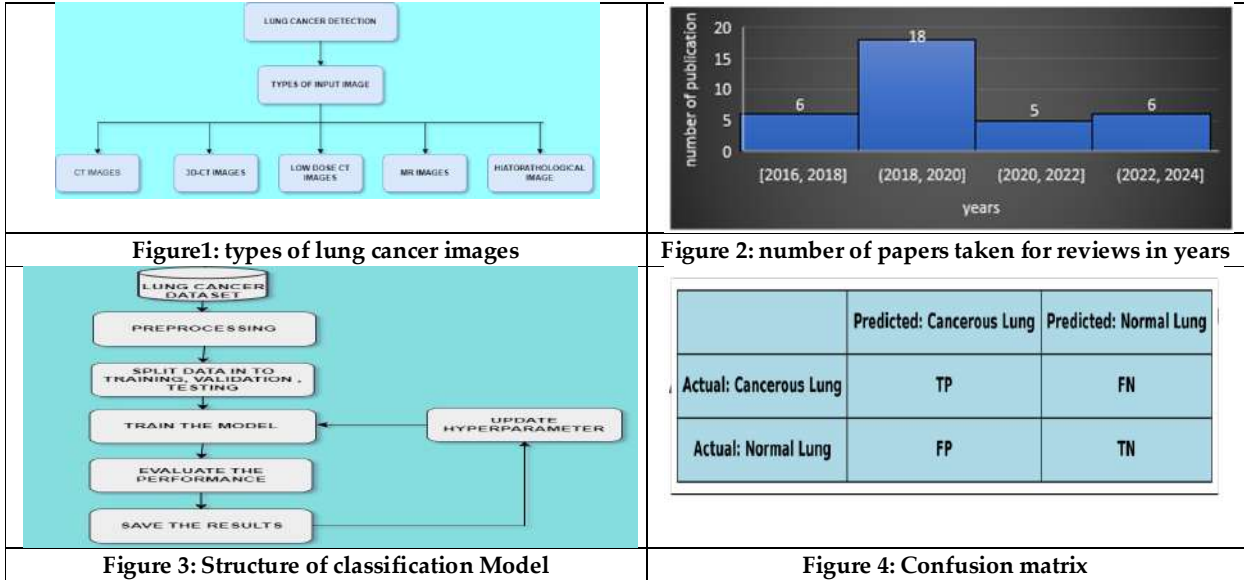
				standard deviation of 0.07.
2019	Nasser, I. M. et al. [18]	“survey lung cancer. “	(ANN)	Accuracy-96.67%
2019	Pang, S. et al. [19]	Shandong Provincial Hospital	Deep learning + DenseNet + Adaboost	Accuracy-89.85% Sensitivity precision
2019	Liu, L. et al. [20]	LIDC-IDRI	MTMR-NET	Accuracy-93.5, Sensitivity-93.0, Specificity-89.4,
2019	Shakeel, P. M. et al. [21]	CIA	(IPCT) + DITNN)	Accuracy -98.42%
2019	Li, Y. et al. [22]	Hospital of Guangzhou Medical University	Deep learning for thoracic MR images	Sensitivity -85.2%
2019	Chen, W. et al. [23]	Hospital Affiliated with Shandong University	HSN	mean Dice score of 0.888, mean Precision score of 0.909,
2019	Lakshmanprabu S.K. et al. [24]	tp://www.via.cornell.edu	ODNN +MGSA	Accuracy 94.56% / sensitivity-96.2% Specificity-94.2%
2019	Zhang C et al. [25]	LUNA -16, Kaggle, Guangdong Provincial People’s Hospital	3DCNN	Sensitivity-84.4% Specificity-83.0%
2019	Jakimovski, G. et al. [26]	Data archive of the University of South Carolina and (LONI)	2CDNN + A regular CDNN	Accuracy -99.6, Specificity -99.9, Precision-98.6
2019	Wang, J. et al. [27]	LIDC-IDRI, LUNA-16, TIANCHI AI,	(FEN) + (RPN) + (RCN)	(FROC) Sensitivity-98.3%
2019	Wang, C. et al. [28]	the standard public digital image database JSRT	Inception-v3 transfer learning	sensitivity -95.41 %, specificity -80.09%
2019	O. Ozdemir et al. [29]	LIDC-IDRI, LUNA-16, Kaggle	Low-Dose CT scan	Sensitivity -96.5%, ROC AUC=0.885
2018	Xie, Y et al. [30]	LIDC-IDRI	(MV-KBC)	Accuracy-91.60%, AUC -95.70%
2018	Liu, Y. et al. [31]	LIDC-IDRI	(DenseBTNet)	AUC score-0.9335
2018	Jin, H. et al. [32]	LUNA-16	A deep 3D residual CNN + SPC layer	Sensitivity-98.3%
2017	Jiang, H. et al. [33]	LIDC-IDRI	Multigroup fragments cut from lung images, augmented by the Frangi filter.	Sensitivity -80.06%, FP/scan-94%
2017	Teramoto, A. et al. [34]	Seventy-six (76) cases of cancer cells. microscopic images	(DCNN)	Accuracy -71%
2016	Dou, Q. et al. [35]	LUNA16	Multilevel contextual 3-D CNN	Sensitivity-94.4%







Seema Kashyap et al.,





## Impact of Employability Factors on Employability Skills: An Analysis of Management Graduates Perspective

Shelly<sup>1\*</sup>, Sultan<sup>2</sup> and Monika<sup>3</sup>

<sup>1</sup>Research Scholar, Department of MMIM, Maharishi Markandeshwar (Deemed to be University), Mullana, Ambala, Haryana, India.

<sup>2</sup>Professor, Department of MMIM, Maharishi Markandeshwar (Deemed to be University), Mullana, Ambala, Haryana, India.

<sup>3</sup>Assistant Professor, Department of MMIM, Maharishi Markandeshwar (Deemed to be University), Mullana, Ambala, Haryana, India.

Received: 22 Jan 2024

Revised: 09 Feb 2024

Accepted: 06 May 2024

### \*Address for Correspondence

#### Shelly

Research Scholar,  
Department of MMIM,  
Maharishi Markandeshwar (Deemed to be University),  
Mullana, Ambala, Haryana, India.



This is an Open Access Journal / article distributed under the terms of the **Creative Commons Attribution License** (CC BY-NC-ND 3.0) which permits unrestricted use, distribution, and reproduction in any medium, provided the original work is properly cited. All rights reserved.

### ABSTRACT

Management institutes consider the improvement in employability skills as a very crucial task these days. Future skills assessments should be designed taking employers' needs and the learners' skill enhancement capabilities into account. There is a huge gap between in the market expectations of employers and what are the skills possessed by the management graduates. In this research, an attempt has been made to identify the factors impacting employability skills of management graduates. A questionnaire for the students was designed and administered to 130 management graduates. Twenty independent variables have been listed to assess the significant impact of factors on employability skills of management graduates in three inter state universities of Haryana, Punjab and Himachal Pradesh. The impact has been identified and measured on two different types of employability skills; basic employability skills and modern employability skills. This study focuses on strategies which are to be practised by the universities for developing employability skills among management graduates which will best serve the future market.

**Keywords:** Employability, market expectations, basic employability skills and modern employability skills.





## INTRODUCTION

In today's age of high expectations, competition and dynamic demand of the market, Employability plays a essential role in the professional growth and achievement of an individual. Gone are the days when people were able to get employed merely with some basic academic knowledge. Now a days, organizations are looking for the manpower whonot only possess basic employability skills but also acquit with some modern or technical skills to have a smooth start with their available skill sets and the primary job requirement. A fresh management graduate who joins the organization for the first time faces the challenge to prove that one can adopt the company's cultural ecosystem and give performance as per the expectations raised. After getting through the barrier of selection process, one should be able to continue to be employed in the long run; for this one needs to possess much more than a management degree. It is very important for the employee to understand the team desire and business needs. 'Employability' has been a big concern for national discussion. Employability has been one of the main challenge for the management institutes. There is need of different line of thinking and action as only 1 in 5 MBA's being employable management graduates, according to the Merit Trac MBA employability Study 2021-2022.

MBA programmes should be much more interfaced with industry to make them more authenticate and complement to the industrial demand. It is the employability skills which play vital role in determining the career-ability of management graduates. Employability refers to acquisition of the skills and capacities required to enter and prosper in the labour market by prospective employees and adapting to the organisational environment in order to be in employment in the long run. The term 'Employability Skill' was first introduced by Conference Board of Canada (CBC) in 1992 and also known as soft skills or competencies skills. These skills are the expertise required for getting the job, keeping and doing well on the job. These can be segregated among three parts as personal skills, core skills & process skills (Yorke & Knight 2006). In the current scenario, competition in the job market is really tough. Employers are expecting for employability skills as a prerequisite trait in their potential employees along with their subject expertise. The skill set of job readiness in essential for every job and industry. Employers value these employability skills because these indicate that how a candidate will get along with team members and different clients and simultaneously and how efficiently he will be able to handle the job responsibilities. Employers are always keenly interested in employability skills because these are essential for productive and smooth functioning of the organisation. In today's world, where the jobs are limited, employers search for individuals which have the basic as well as modern skill set suitable to the work in order to get best productivity from the employees and to save reasonable amount of time and money for developing readiness for work skills through orientation. (Karin Kelly 2022).

## REVIEW OF LITERATURE

The employability skills have been interesting economic agenda in the countries from past two decades like United states, New Zealand, Canada, UK, Australia, Denmark and others...(Sung et al. 2013). Employability skills are defined by different terminologies in different countries, such as 'transferable skills', 'personal skills', 'key competencies', 'core competencies', 'soft skills', describe the expected employability skill set the workplace(Naanda 2010).Different concept and terms of employability skills are used wide different country's framework such as France referred these as 'transferable skills', Germany termed these as 'key qualifications', Switzerland called them as 'trans-disciplinary goals', Denmark referred these as 'process independent qualifications', United Kingdom termed these as 'key skills, common skills, core skills', USA called as 'workplace know-how, necessary skills, basic skills', Australia referred as 'key competencies, employability skills, generic skills', Singapore as 'critical enabling skills training', while Malaysia called these as 'employability skills' (Raybould 2015; Sung et al. 2013; Matters & Curtis 2008; Kämäräinen 2002).There is different understanding regarding concept of employability skills and no common terminology agreement contexts. Kearns 2001 added that it is desirable to find common terminology for employability between different stakeholders such as higher education, individuals, employers and communities



**Shelly et al.,**

(Subramanian 2017). Moreover, despite of the fact that employability has been globally elucidated as a cluster of skills, characters, traits and attributes that employers look forward from workers (Lowden et al., 2019), there are less researches which indicate that how the employability should be specifically described for graduate students. It is found that there is a significant improvement in the skills, traits, attributes and characteristics developed by graduate level students than those developed at the undergraduate level, though the restricted studies on employability are focused on individuals' employability who just completed undergraduate level education (Finch et al., 2013; Wickramasinghe and Perera, 2020). Moreover there are limited research on employability focusing largely student perceptions of employability. Despite employers are key controlling factors in labour market outcomes, it is required to analyse the view point of the employees (Chowdhury, 2019; Blackwell et al., 2001; Gault et al., 2000). Harvey et al (2022) tried to identify the difference between initial employability skills to find employment and advanced employability skills to support learning and employability on a continuing basis. He examined that students' view point of employability is smaller and limited to recognition of the connection between initial skills and gaining employment immediately after degree, they are not concerned about a lengthy and maintainable career (Tymon, 2011). The employability is a comprehensive and extensive concept, some sincere work has been initiated by the universities to submerge employability into the curriculum, even after their initiatives, employers continued to be dissatisfied about the employability skills and found these insufficient amongst graduates to meet the market demand (CBI, 2011); Ehiyazaryan and Barraclough (2009) predicated that there is need that skills needs to be developed according to a real world requirement rather than the mere classroom transactions.

It should be more practical based rather than theory. Employability skills comprise a diverse abilities that help the individual to shift from one job role to another. Bremner (2018) defined that employability skills as required skills which make the employees adaptable in different environment. The CBI (2009) referred to employability skills as comprehensive soft skills including communication and interpersonal skills and problem solving and decision making skills. Murakami et al (2009) believed that social adaptability is a main skill required for placement that supports learning at the workplace and subsequently in long term career. It is observed that finding a singular employability skills list is difficult due to the diverse and complicated nature of skills. Mason et al (2014) argued that some specific employability skills can only be learned while doing a job in the workplace, the degree should be in complement to the experience achieved on placement and to maximise the development of skills (Bourne and Ellerker, 1998). Though the placements are instrument for personal and professional development but having employability skills give value addition to a graduate in the market (Tomlinson, 2018). Now the employers are looking forward to graduates who are able to make an immediate contribution to their organization (Wickramasinghe and Perera, 2020). Placement students are in their final semester and obviously to be graduate with in a period of six months i.e. final semester after completing their course (Mason et al, 2014); As the very first job have a long lasting impact on successful career, thus it is very significant to start with a right and strong position (Mosca and Wright, 2017). Graduate recruiters and placement organisations are employing students who have some kind of work experience in term of some training or internship; it was anticipated in 2023 that 38% of new opening positions will be filled by graduates with some past work experience and exposure (High Fliers Research, 2022). The employers value the students ability to display their contribution based on actual work and their past work experience helps an organisation to fully assess an individual's capabilities.

**RESEARCH OBJECTIVES**

1. To identify the factors leading to low employability among the management graduates.
2. To analyse the impact of factors of employability on employability skills among management graduates.





Shelly et al.,

## RESEARCH METHODOLOGY

To achieve the objectives of the study, twenty factors affecting employability are examined with two sets of employability skills i.e. basic employability skills and modern employability skills. Each skill set has twelve sub-skills.

### Research Hypotheses

**H<sub>01</sub>:** There is no significant impact of factors affecting employability on the development of basic employability skill.

**H<sub>02</sub>:** There is no significant impact of factors affecting employability on the development of modern employability skill.

## MATERIALS AND METHODS

The current study is based on a student's survey analysis. Data were collected from 130 management graduates using a self-structured questionnaire based on a 5-point Likert scale, with 81 males and 49 females.

## RESULTS AND ANALYSIS

In this study, structural equation modelling is used with maximum likelihood method of estimation. After getting acceptable reliability, two hypotheses were tested with factors affecting employment and employability skills. The study also intends to portray the standardized and unstandardized regression weights to defend the impact of the selected statements of each predictor with basic and modern employability skills. Thus, the data collected related to employability and skills gap among management graduates were analysed with structural equation modelling to examine the impact on employability skills. Table 1 explains the standardized and unstandardized regression weights (Factor loadings) were also evaluated to determine the impact of the factors affecting employability on employability skills. All of the loadings were higher than the recommended value of 0.5. In case of employability skills as predictor, a standardized coefficients shows strong relationship with motivation among students in order of enhance skills (0.619), followed by Early education gaps of students (0.617), academic achievements (0.524), participation in extra-curricular activities (0.520), focus on theoretical teaching-learning process (0.600), curriculum and practices (0.658), use of latest technology in course content (0.639), skill-based learning (0.685), competency or quality of teachers (0.744), innovation and research in teaching (0.764); motivation and commitment among teachers (0.764), reputation of educational institution (0.695), future aspirations/goals of students (0.756), Geographical immobility (0.735), salary expectations (0.604), Mismatch between requisite and available skills (0.828), job requirement at the beginning (0.790), selection process (0.707), growth rate of economy (0.666).

It has been found that there is a strong relationship between factors affecting employability and employability skills of management graduates, hence the null hypothesis (H<sub>01</sub>) is rejected. Similarly, for Basic employability skills as predictor, a standardized coefficient shows strong relationship and impact of factors affecting employability on communication skills (0.834), presentation skills (0.704), creativity skills (0.817), problem solving and analytical skills (0.781), decision making skills (0.792), leadership skills (0.758), negotiation skills (0.695), stress management skills (0.729), team work skills (0.711), delegation skills (0.640); ICT skills (0.589), experiential learning and adaptive skills (0.746). It has been analysed that there is a strong relationship between factors affecting employability and basic employability skills among management graduate, hence the null hypothesis (H<sub>01</sub>) is rejected. Likewise, for modern employability skills as predictor, a standardized coefficient shows strong relationship and impact of factors affecting employability on sense making and social intelligence skills (0.712), novelty and innovative skills (0.779); cross cultural competency skills (0.693), trans disciplinary skills (0.838), design mind set skills (0.759), cognitive load management skills (0.755), new media literacy skills (0.862), virtual collaboration skills (0.712), remote team





**Shelly et al.,**

management skills(0.757), learning agility skills (0.758), DEI Skills (0.769), and emotional intelligence skills(0.745). Again, it has been found that there is a strong relationship between factors affecting employability and modern employability skills among management graduate, hence the null hypothesis ( $H_{02}$ ) is rejected.

$\chi^2$  = Chi Square, DF = Degree of freedom, RMSEA = Root mean square error of approximation, CFI = Comparative-fit-index, NFI = Normed fit index, PNFI = Parsimony normed fit index, PCFI= Parsimonious Comparative Fit Index, TLI = Tucker–Lewis coefficient index,  $\Delta$ IFI= Increment fit index Table 2 explains the model fit summary of this structural equation modelling. The results obtained using AMOS are according to their admissible values such as CMIN is 3.251; Root Mean Square Error of Approximation is 0.132; Comparative fit-index 0.614; Normed fit-index is 0.527; Parsimonious normed fit-index 0.502; Parsimonious Comparative fit-index 0.584; hence the proposed model is validate. The study also intends to portray the standardized and employability skills with factors affecting employability. Thus, the data collected related to employability and skills gap among management graduates are analysed with structural equation modelling. The results obtained with help in examining the relationship of factors affecting employability. Figure 1 & Figure 2 explains that there is significant impact of factors affecting employability on employability skills. The study also intends to portray the unstandardized regression weights to defend the relationship of the selected statements of each predictor with factors. Thus, the data collected related to employability and skills gap among management graduate is analysed in SPSS Amos Program. The results obtained help in examining the relationship of factors affecting employability as well as in testing the hypotheses formulated.

## CONCLUSION

In this research paper, the predictors are evaluated with the help of structural equation modelling and the impact of factors affecting employability on employability skills are analysed. The results show that there is strong relationship and impact of factors affecting employability and skill sets and the highest standardized regression weights are 0.828. The impact on basic employability skills is prominent, which shows highest standardized regression weights 0.817 whereas for modern employability skills highest standardized regression weights is found to be 0.862. The values of CMIN and RMSEA are found to be 3.251 and 0.132 respectively, which indicate the good fit index values for the proposed model and hence, the model is validated and found to be appropriate.

### Recommendations of the study

This study will help in understanding the various factors affecting the employability and their impact on employability skills. As it is evident from the model that there is a positive relation between factors affecting employability and employability skills, the management institutes and universities can make an effort in improving in their curriculum and make their teaching learning practices more practical to ensure the development of employability skills among management graduates.

## REFERENCES

1. Bremner, P.A.M. (2018). The Gap between Degree Outcome and Employability Skills. Presented at 15th Enhancement in higher education conference: Evaluation, Evidence and Enhancement: Inspiring Staff and Students. 07 June 2018.
2. Chowdhury, T.A.& Miah, M.K.(2019). Perceptions of students and employers regarding employability skills for entry-level positions in marketing and sales. *Australian Journal of Career Development*, 28(1), 3-13
3. Ehiyazaryan, E. and Barraclough, N. (2009) Enhancing employability: integrating real world experience in the curriculum *Education and Training*, 51(4), 292-308.
4. Finch, J. & Pollard, E. (2013). Employability: Developing a Framework for Policy Analysis. *Institute for Employment Studies*, ISBN 0 85522 889 X. Available at <https://www.researchgate.net/publication/225083565>





## Shelly et al.,

5. Gomez, S., Lush, D. and Clements, M. (2004) Work placements enhance the academic performance of bioscience undergraduates *Journal of vocational education and training* 56(3), 373-385.
6. Gracia, L. and Jenkins, E. (2003) A quantitative exploration of student performance on an undergraduate accounting programme of study, *Accounting Education: An International Journal*, 12(1) pp15-32.
7. Harvey, L. Locke, W. and Morey, A. (2022) Enhancing employability, recognising diversity. Making links between higher education and the world of work. London: Universities UK.
8. High Fliers Research (2022) The Graduate Market in 2022 London: High Fliers Research Limited [online]. Available at: <http://www.highfliers.co.uk/download/GMReport12.pdf>
9. Hillage, J. and Pollard, E. (1998) Employability: Developing a framework for policy analysis, Department for Education and Employment (DfEE) Research Brief No. 85,
10. Knight, P. and Yorke, M. (2004) Learning, Curriculum and Employability in Higher Education London, 38(7), 963-984.
11. G.W. and Jolly, A. (2019) Graduate identity and employability, *British Educational Research Journal*, 37(4), 563-584.
12. Lynlea, S., Shacklock, K. & Marchant, T. (2017) in Employability: A contemporary review for higher education stakeholders. *Journal of Vocational Education & Training*, <http://www.tandfonline.com/loi/rjve20>
13. Matters, B.E.&Curtis, J. C. (2008). Employability Skills as Perceived by Employers and University Faculty in the Fields of Human Resource Development (HRD) for Entry Level Graduate Jobs. *Journal of Human Resource and Sustainability Studies*, 4, 39-49.
14. Mansfield, R. (2011) The effect of placement experience upon final-year results for surveying degree programmes, *Studies in Higher Education*,38(8),939-952.
15. Mason, G., Williams, G. and Cranmer, S. (2014). Employability skills initiatives in higher education: what effects do they have on graduate labour market outcomes? *Journal of Economics Education*17(1),1-30.
16. Mosca, I. and Wright, R.E. (2017). Is Graduate Under-employment Persistent? Evidence from the United Kingdom. Institute for the Study of Labor Discussion Paper No. 6177 [online]. Available at: <http://ftp.iza.org/dp6177.pdf>
17. Murakami, K., Murray, L., Sims, D. and Chedzey, K. (2009) Learning on Work Placement: The Narrative Development of Social Competence, *Journal of Adult Development*, 16(1),13-24.
18. Naanda(2010)The integration of identified employability skills into the Namibian vocational education and training curriculum. Available at: <https://scholar.sun.ac.za/items/2bdfb142-2b2d-4a6d-a623-5dff67002a9c>
19. Neill, N.T. and Mulholland, G.E. (2013) Student placement – structure, skills and e-support, *Education and Training*, 45(2),89-99.
20. Purdie, F., McAdie, T., King, N. and Ward, L. (2011). In the right placement at the right time? An investigation of the psychological outcomes of placement learning, *Procedia – Social and Behavioral Sciences*, 29,717-724.
21. Rawlings, P., White, P. and Stephens, R. (2013). Practice-based learning in information systems: the advantages for students, *Journal of Information Systems Education*,16(4),455-464.
22. Raybould, J. and Sheedy, V. (2015). Are graduates equipped with the right skills in the employability stakes? *Journal of Industrial and Commercial Training*, 27(5), 259-263.
23. Reddy, P. and Moores, E. (2006). Measuring the benefits of a psychology placement year, *Journal of Assessment and Evaluation in Higher Education*, 31(5), 551-567.
24. Subramanian, K.R. (2017). in Higher Education And Employability Skills, *International Journal of Combined Research & Development (IJCRD)* 6(1), 317-321
25. SurrIDGE, I. (2009). Accounting and finance degrees: is the academic performance of placement students better? *Accounting Education* 16(4), 471-485.
26. Tomlinson, M. (2018). The degree is not enough: students “perceptions of the role of higher education credentials for graduate work and employability *British Journal of Sociology of Education*, 29(1),49-61.
27. Tymon, A. (2011). The student perspective on employability Studies in Higher Education, *Journal of Education and Training*14(2), 1-16.
28. Walker, F. and Bowerman, M. (2010) Beyond Placement Extinction [online]. Available at: [http://www.hecsu.ac.uk/graduate\\_market\\_trends\\_summer\\_2010\\_beyond\\_placement\\_extincti on.htm](http://www.hecsu.ac.uk/graduate_market_trends_summer_2010_beyond_placement_extincti on.htm)





**Shelly et al.,**

29. Wickramasinghe, V. and Perera, L. (2020). Graduates', university lecturers' and employers' perceptions towards employability skills Education and Training, 52(3),226-244.

**Table 1: Standardized and Unstandardized Regression Weight**

Factors	Variables	Path	Factors	Unstandardized Regression Weight	S.E.	Standardized Regression Weight	C.R.	P
<b>Factors</b>	Fac1	<---	<b>FAC</b>	1.000		0.634	6.391	***
	Fac2	<---		0.936	0.146	0.619	6.284	***
	Fac3	<---		0.897	0.143	0.617	5.439	
	Fac4	<---		0.792	0.146	0.524	5.400	***
	Fac5	<---		0.808	0.150	0.520	6.053	***
	Fac6	<---		0.978	0.162	0.600	6.541	***
	Fac7	<---		1.060	0.162	0.658	6.419	***
	Fac8	<---		1.009	0.157	0.639	6.805	***
	Fac9	<---		1.009	0.148	0.685	7.251	***
	Fac10	<---		1.375	0.190	0.744	7.431	***
	Fac11	<---		1.281	0.172	0.764	7.406	***
	Fac12	<---		1.302	0.176	0.764	6.934	***
	Fac13	<---		1.286	0.185	0.695	7.383	***
	Fac14	<---		1.284	0.174	0.756	7.160	***
	Fac15	<---		1.225	0.171	0.735	6.123	***
	Fac16	<---		1.067	0.174	0.604	7.888	***
	Fac17	<---		1.285	0.163	0.828	7.605	***
	Fac18	<---		1.251	0.164	0.790	7.043	***
	Fac19	<---		1.198	0.170	0.707	6.632	***
	Fac20	<---		1.320	0.199	0.666	6.391	***
<b>Basic skills</b>	BES1	<---	<b>BES</b>	1.000		0.803	7.043	***
	BES2	<---		0.858	0.097	0.704	6.632	***
	BES3	<---		1.003	0.093	0.817		
	BES4	<---		0.931	0.093	0.781	8.813	***
	BES5	<---		0.954	0.094	0.792	10.771	***
	BES6	<---		1.035	0.109	0.758	10.011	***
	BES7	<---		0.918	0.108	0.695	10.112	***
	BES8	<---		0.982	0.107	0.729	9.475	***
	BES9	<---		0.936	0.106	0.711	8.520	***
	BES10	<---		0.770	0.100	0.640	9.140	***
	BES11	<---		0.767	0.110	0.589	8.824	***
	BES12	<---		0.908	0.098	0.746	7.671	***
<b>Modern Skills</b>	MES1	<---	<b>MES</b>	1.000		0.712	6.965	***
	MES2	<---		1.168	0.135	0.779	9.259	***
	MES3	<---		1.006	0.129	0.693		
	MES4	<---		1.174	0.127	0.838	8.677	***
	MES5	<---		1.127	0.134	0.759	7.799	***
	MES6	<---		1.120	0.134	0.755	9.276	***
	MES7	<---		1.438	0.151	0.862	8.399	***
	MES8	<---		1.111	0.140	0.712	8.383	***
	MES9	<---		1.138	0.136	0.757	9.540	***
	MES10	<---		1.095	0.131	0.758	7.924	***







**Shelly et al.,**

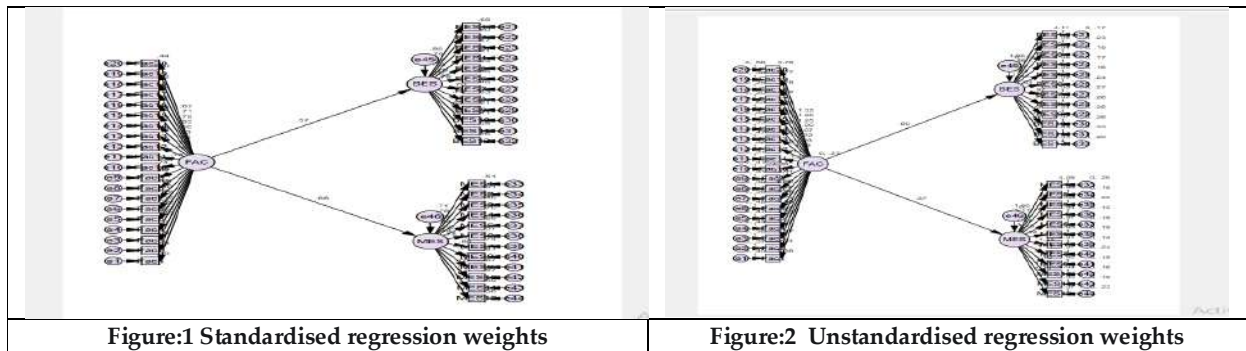
	MES11	<---		1.170	0.136	0.769	8.361	***
	MES12	<---		1.203	0.146	0.745	8.392	***

Source: Data compiled from AMOS

**Table-2: Model fit Summary**

Fit index	Cited	Results	Admissibility
CMIN	(Kline,2010)	3.251	1.00-5.00
RMSEA	(Steiger,1990)	0.059	≤ 0.1
CFI	(Byrne,2010)	0.614	≥ 0.90
NFI	(Bentler&G.Bonnet,1980)	0.527	>0.80
PNFI	(Bentler&G.Bonnet,1980)	0.035	>0.05
PCFI	(James and Brett,1982)	0.584	>0.50

Source: Data compiled from AMOS





## Prevalence of Zygomatic Air Cell Defect in Western Population of Rural Maharashtra

Anjum Ara J Farooqui<sup>1</sup>, Jamebaseer M Farooqui<sup>2\*</sup>, Anita D Munde<sup>3</sup>, Anwesha Samanta<sup>4</sup> and Sudharani Biradar<sup>1</sup>

<sup>1</sup>Associate Professor, Department of Oral Medicine and Radiology, Rural Dental College, Pravara Institute of Medical Sciences (Deemed to be University), Loni, Maharashtra, India.

<sup>2</sup>Professor, Department of Forensic Medicine and Toxicology, Dr Balasaheb Vikhe Patil, Rural Medical College, Pravara Institute of Medical Sciences (Deemed to be University), Loni, Maharashtra, India.

<sup>3</sup>Professor, Department of Oral Medicine and Radiology, Rural Dental College, Pravara Institute of Medical Sciences, (Deemed to be University), Loni, Maharashtra, India.

<sup>4</sup>Senior Lecturer, Department of Oral Medicine and Radiology, Rural Dental College, Pravara Institute of Medical Sciences, (Deemed to be University), Loni, Maharashtra, India.

Received: 22 Jan 2024

Revised: 09 Feb 2024

Accepted: 08 May 2024

### \*Address for Correspondence

#### Jamebaseer M Farooqui

Professor,

Department of Forensic Medicine and Toxicology,

Dr Balasaheb Vikhe Patil, Rural Medical College,

Pravara Institute of Medical Sciences (Deemed to be University),

Loni, Maharashtra, India.

Email: fanjumj@gmail.com



This is an Open Access Journal / article distributed under the terms of the **Creative Commons Attribution License** (CC BY-NC-ND 3.0) which permits unrestricted use, distribution, and reproduction in any medium, provided the original work is properly cited. All rights reserved.

### ABSTRACT

Pneumatized air cells located in the zygomatic process of the temporal bone are defined as Zygomatic Air Cell Defects (ZACDs). ZACDs have been termed as 'accessory air cells in the zygomatic process and articular eminence of the temporal bone, which resembles to mastoid air cells and which do not extend more anteriorly than the zygomatico-temporal suture. [1] ZACDs radiographically appears as nonexpansile and nondestructive radiolucency in the zygomatic process of the temporal bone or the articular eminence and is clinically asymptomatic. These air spaces can be breached during trauma to maxillofacial structures. Fracture or dehiscence of the glenoid fossa may lead to seeping of soft tissue contents into the middle ear and further result in the middle ear infections and mastoid effusion. They may serve as an entry port for mastoid tumors to extend into temporomandibular joint (TMJ). [5]

**Keywords:** ZACDs radiographically appears as nonexpansile and nondestructive radiolucency in the zygomatic process of the temporal bone or the articular eminence and is clinically asymptomatic.





## INTRODUCTION

Pneumatized air cells located in the zygomatic process of the temporal bone are defined as Zygomatic Air Cell Defects (ZACDs). ZACDs have been termed as 'accessory air cells in the zygomatic process and articular eminence of the temporal bone, which resembles to mastoid air cells and which do not extend more anteriorly than the zygomatico-temporal suture. [1] The term Zygomatic air cell defect, was proposed by Tyndall and Matteson in the year 1987. This entity is also known as Pneumatized Articular Eminence (PAE), coined by the same previous investigators in 1985, and Pneumatized Articular Tubercle (PAT).[2] They classified ZACD into three types as Unilocular, Multilocular and Trabecular. It presents as asymptomatic, non expansile, nondestructive radiolucency. Unilocular type is seen as an oval radiolucent defect with well defined borders and the multilocular appear as numerous small cavities inside and resemble mastoid air cells. It may become contraindications for performing surgical procedures such as eminectomy as they can become potential pathways for intracranial infections, when ZACDs have been demonstrated preoperatively on a radiograph. [3], Several imaging modalities have been used for assessing the pneumatization of the articular tubercle (PAT) and glenoid fossa (PGF) in earlier studies. Panoramic radiographs were considered the technique of choice for evaluation of these defects because of its wide availability, low cost and lower radiation dose when compared to CBCT.

### Aims

To determine the prevalence, patterns of occurrence of zygomatic air cell defects using digital panoramic radiographs in Western Maharashtra

## MATERIALS AND METHODS

200 digital panoramic radiographs were examined to evaluate the variations and characteristics of ZACDs. Exclusion Criteria Patient with developmental malformation of face and jaw. History of trauma to maxillofacial region. Any pathologies in maxillofacial region.

### METHODOLOGY

A retrospective pilot study of 200 panoramic radiographs was carried out in the Department of Oral Medicine and radiology. The study population comprised 200 panoramic radiographs between the age group of 12-85 years. All radiographs were obtained with digital panoramic radiographic machine (Dentium Rainbow, Korea). All the radiographs were processed automatically using Fujifilm medical dry laser imager fm-dl 100 Japan. The data collected were tabulated and subjected to statistical analysis.

## RESULT

The study sample consisted of 200 patients. 127 (63.5%) participants were Males; 73 (36.5%) were Females with a mean age of  $39.17 \pm 17.91$  with a range of 12–81 years. 40 (20%) participants presented with ZACD among these 32 (80%) were male and 8 (20%) were female. [ Table 1]. The prevalence of ZACDs in the present study was 20% subjects with 32 (80%) in males and 8 (20%) in females. The highest incidence was noted in males. The ZACD noted in youngest patient was 12yrs and the oldest was 82yrs old. In the detailed radiological examination, the distribution of ZACD was as follow,

- Bilateral Multilocular type of ZACD was seen in 5 (12.5%).[Figure 4]
- Bilateral Unilocular type of ZACD was seen in 10 (25%) .[Figure 2]
- Unilateral Multilocular type of ZACD was seen in 3(7.5%) on Right side and in 2 (5%) on Left side.[Figure 3]
- Unilateral Unilocular type of ZACD was seen in 7(17.5%) on Right side and in 11(27.5%) on Left side. [Figure 1]





Anjum Ara J Farooqui et al.,

- And the Unilateral Unilocular and Unilocular Bilateral type of ZACD was the most common pattern noticed in our study.

## DISCUSSION

ZACDs radiographically appears as nonexpansile and nondestructive radiolucency in the zygomatic process of the temporal bone or the articular eminence and is clinically asymptomatic. These air spaces can be breached during trauma to maxillofacial structures. Fracture or dehiscence of the glenoid fossa may lead to seeping of soft tissue contents into the middle ear and further result in the middle ear infections and mastoid effusion. They may serve as an entry port for mastoid tumors to extend into temporomandibular joint (TMJ). [5] Otitis or mastoiditis expanding to the TMJ can result in ankylosis of TMJ. Diseases such as the aneurysmal bone cyst, central hemangioma, eosinophilic granuloma, fibrous dysplasia and have been recognized to have involved the zygomatic processes of the temporal bone. If the zygomatic process of the temporal bone or the articular eminence shows a unilocular or multilocular radiolucency which is incidental then it is suggestive of a ZACD. It is important to the radiologists, diagnosticians, surgeons to be aware of this entity so that accurate identification can be made, leading to prevention of unnecessary investigations and explorations and helps to prevent potential complication[1] A wide range variation of the prevalence rates of zygomatic air cell defect have been observed from as low as 1% (Kaugars et al 1985) [6] to as high as 65.8% (İlgüy et al 2015) [7]. The overall prevalence of ZACD in the present study was 20% which is in accordance with the studies conducted by ELBeshlawy[8]. The results are not consistent with study conducted by Carter et al.[9], Hofmann et al.,[10] Asieh Zamaninaser et al.[11] The disparity in the prevalence of ZACD can be due to the variation in the sample size, population studied and methodology. Shokri et al, Mosavat and Ahmadi found that unilateral lesions were significantly more frequent than bilateral lesions which is in contrast to our study where there is not much difference seen between unilocular ZACD and bilateral unilocular ZACD [12,13]. Alternatively, two studies found that the prevalence of bilateral PAT cases were higher than unilateral ones. To clarify, these previous researches pointed out that there is no predisposing factor for the occurrence of unilateral or bilateral pneumatization [7,8,14]. İlgüy et al 1 showed that unilateral PGF was more common than bilateral PGF, which is also similar to our study[7] In the present study, unilateral ZACD cases were observed on the left side more than the right side, however, the evaluation between both sides was not statistically significant.

This result is consistent with the results of many researches[8,15,16] On the opposite side, in a study conducted by Orhan et al, the proportion of unilateral PAT cases on the right side was higher. However, in many other researches, there were no statistically significant differences in terms of pneumatization between the right and left sides[ 3,9,14] Again, no mechanism has been proposed in the literature to explain the cause why pneumatizations may occur on any side in terms of laterality [16] Comparable to other similar surveys, in the present research, ZACDs were nearly twice as common in males than in females with a mean value  $23.93 \pm 11.67$ , which is similar to a study done by Arora et al ., [17]. It also has been noted that certain other studies revealed no gender predilection . Hence it is difficult to reach a consent on the gender prevalence of ZACDs. However, this variation could be attributed to random enrollment of study subjects irrespective of the gender. This was in contrast with study by Orhan and associates, which had more female subjects (61.4%) could probably explain the greater occurrence of ZACD in females, whereas in the study by Park et al., although male subjects were less (47%) than the female subjects (53%), a higher male occurrence of ZACD was found [3,5,18]. In the present study the Unilocular bilateral ZACD are found to be more prevalent with a percentage of 25%, which is similar to a study done by Salli et al[19] recorded that 67.7% were bilateral as well as Ladeira et al[16] that revealed 57.5% bilateral PGF. In the literature, no obvious reason has been identified that may influence the likelihood of unilateral or bilateral PGF[6] To summarize, there is a wide variability reported in the literature considering the temporal bone pneumatization prevalence, laterality, locularity and age distribution. This may be governed by racial, genetic or environmental factors. The prevalence of PAT and PGF should be assessed individually in every population then studies on each population should be collected and used as population specific data. Even though no treatment is necessary for PAT or PGF, the clinical importance of their recognition is important in patients undergoing surgical interventions or suffering from pathological lesions of the





**Anjum Ara J Farooqui et al.,**

region as they stand for areas of least resistance that might complicate the surgical procedures or facilitate the spread of various pathologies. CBCT scans provide a powerful diagnostic aid that should be regularly used for diagnostic and preoperative assessment purposes of the temporal air spaces.[8]

## CONCLUSION

In conclusion, the present study showed significant incidence of pneumatization of temporal regions of the TMJ. However treatment of pneumatized articular eminence and glenoid fossa is not necessary, once observed should be kept under inspection as they may provide the least resistance to the spread of infection and tumors and also offer least resistance to trauma. It is also important to know this anatomical aberration as they may be confused with an aneurysmal bone cyst, hemangioma, eosinophilic granuloma, fibrous dysplasia or metastatic tumor. Close examination of the pneumatization of the mastoid process can aid treatment planning in such circumstances, further studies are required on a larger population and for accurate diagnosis advanced imaging modalities such as CBCT is an effective imaging method for accurate analysis of this region.

## REFERENCES

1. Sunita Kulkarni et al. Zygomatic Air Cell Defect: A Digital Panoramic Retrospective Pilot Study. International Journal of Health Sciences & Research 2017 June ; 6 (7):347.
2. Tyndall D, Matteson S. Radiographic appearance and population distribution of the pneumatized articular eminence of the temporal bone. J Oral Maxillofac Surg. 1985; 43:493–497.
3. Orhan K, Delilbasi C, Orhan AI. Radiographic evaluation of pneumatized articular eminence in a group of Turkish children. Dentomaxillofacial Radiology. 2006 Sep;35(5):365-70.
4. Nagaraj T, Nigam H, Balraj L, Santosh H, Ghouse N, Tagore S. A population-based retrospective study of zygomatic air cell defect in Bengaluru. J Med Radiol Pathol Surg. 2016 Nov 1;3(6):5-8.
5. Park YH, Lee SK, Park BH, Son HS, Choi M, Choi KS, An CH. Radiographic evaluation of the zygomatic air cell defect. Korean Journal of Oral and Maxillofacial Radiology. 2002 Dec 1;32(4):207- 12.
6. Kaugars GE, Mercuri LG, Laskin DM. Pneumatization of the articular eminence of the temporal bone: prevalence, development, and surgical treatment. J Am Dent Assoc 1986; 113:55–57 .
7. İlgüy M, Dölekoğlu S, Fişekçioğlu E, Ersan N, İlgüy D. Evaluation of Pneumatization in the Articular Eminence and Roof of the Glenoid Fossa with Cone-Beam Computed Tomography Balkan Med J 2015;32:64-8
8. ELBeshlawy D. CBCT Assessment of pneumatization of the Articular Tubercle and the Roof of the Glenoid Fossa: a retrospective study. Egyptian Dental Journal. 2020 Jul 1;66 (3) 1553-1556
9. Carter LC, Haller AD, Calamel AD, Pfaffenbach AC. Zygomatic air cell defect (ZACD). Prevalence and characteristics in a dental clinic outpatient population. Dentomaxillofac Radiol 1999; 28: 116-22
10. Hofmann T, Friedrich RE, Wedl JS, Schmelzle R. Pneumatization of the zygomatic arch on pantomography. Mund Kiefer Gesichtschir 2001; 5: 173-9
11. Zamaninaser A, Rashidipoor R, Mosavat F, Ahmadi A. Prevalence of zygomatic air cell defect: Panoramic radiographic study of a selected Esfahanian population. Dent Res J 2012;9:S63-8.
12. Shokri A, Safi Y, Mortazavi H, Baharvand M, Fallah-Koshki S. Cone beam-computed tomography evaluation of pneumatized articular tubercle. Int J Clin Dent 2015; 8:63-71.
13. Mosavat F and Ahmadi A. Pneumatized Articular Tubercle and Pneumatized Roof of Glenoid Fossa on Cone Beam Computed Tomography: Prevalence and Characteristics in Selected Iranian Population. Journal of Dentomaxillofacial Radiology, Pathology and Surgery 2015; 4(3): 10-14.
14. Khojastepour L, Paknahad M, Abdalipur V, Paknahad M. Prevalence and Characteristics of Articular Eminence Pneumatization: A Cone-Beam Computed Tomographic Study. J Maxillofac Oral Surg 2018;17(3):339–344.





**Anjum Ara J Farooqui et al.,**

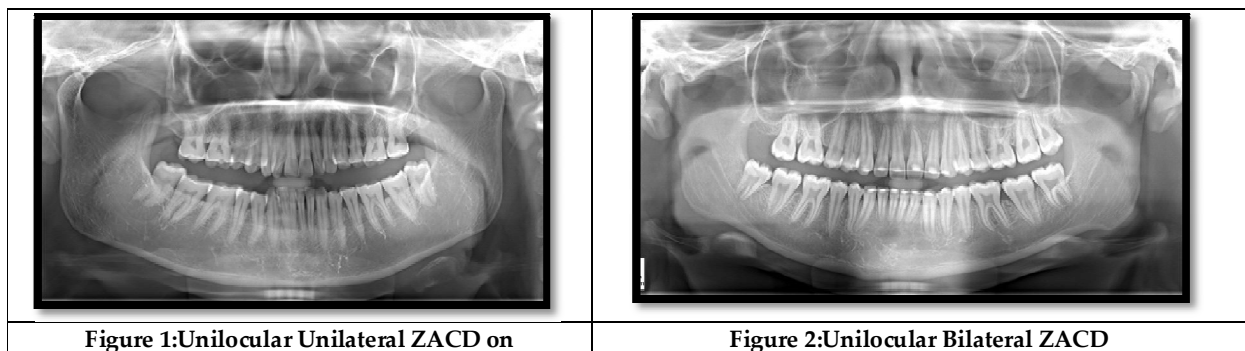
15. Şallı, G.A, Özcan, İ & Pekiner, FN. Prevalence of pneumatization of the articular eminence and glenoid fossa viewed on cone-beam computed tomography examinations in a Turkish sample. *Oral Radiol* 2020; 36: 40–46.
16. Ladeira DB, Barbosa GL, Nascimento MC, Cruz AD, Freitas DQ, Almeida SM. Prevalence and characteristics of pneumatization of the temporal bone evaluated by cone beam computed tomography. *Int J Oral Maxillofac Surg* 2013; 42:771–775
17. Arora KS, Kaur P, Kaur K. ZACD: A Retrograde Panoramic Analysis among Indian Population with New System of Classification. *JCDR* 2016; 10(1): ZC71-ZC73.
18. K. Patil et al. / *European Journal of Radiology* 81 (2012) 957– 959 Prevalence of Zygomatic Air Cell Defect in adults –A retrospective panoramic radiographic analysis
19. Şallı, G.A, Özcan, İ & Pekiner, FN. Prevalence of pneumatization of the articular eminence and glenoid fossa viewed on cone-beam computed tomography examinations in a Turkish sample. *Oral Radiol* 2020; 36: 40–46.

**Table-1 Prevalence of Zygomatic air cells defect among participants**

Total no of participants		Participants with Zygomatic air cells	
200 (100%)		40 (20%)	
Male	Female	Male	Female
127 (63.5%)	73 (36.5%)	32 (80%)	8 (20%)
Age	39.17 ±17.91	Age	23.93 ± 11.67

**Table 2- Descriptive Statistics**

Characteristics	Positive	No.	%
Side	Right	10	25 %
	Left	13	32.5 %
	Bilateral	15	37.5 %
Unilocular	Right	7	17.5 %
	Left	11	27.5 %
	Bilateral	10	25 %
Multilocular	Right	3	7.5 %
	Left	2	5.0 %
	Bilateral	5	12.5 %





Anjum Ara J Farooqui *et al.*,



Figure 3:Multilocular Unilateral ZACD

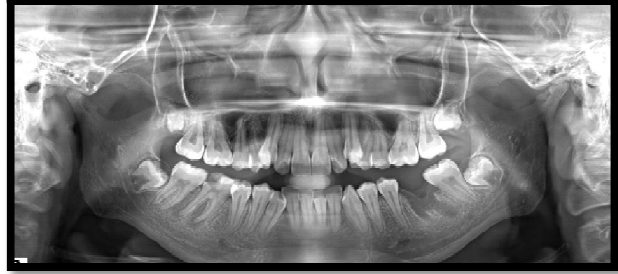


Figure 4:Multilocular Bilateral ZACD





## Effectiveness of Right Side lying Respiratory Left Adductor Pull Back Exercise (RSRLAPB) with Static Stretching on Hip Adduction Rom and Lower Extremity Function in Long Distance Runners with Iliotibial Band Tightness: A Pilot Study

Heli Parikh<sup>1</sup>, Vrunda Gujjar<sup>2\*</sup> and Gaurav J Patel<sup>3</sup>

<sup>1</sup>MPT Scholar, Department of Physiotherapy, Ahmedabad Physiotherapy College, Parul University, Gujarat, India.

<sup>2</sup>Assistant Professor, Department of Physiotherapy, Ahmedabad Physiotherapy College, Parul University, Gujarat, India.

<sup>3</sup>Principal, Department of Physiotherapy, Ahmedabad Physiotherapy College, Parul University, Gujarat, India.

Received: 22 Jan 2024

Revised: 09 Feb 2024

Accepted: 07 May 2024

### \*Address for Correspondence

**Vrunda Gujjar**

Assistant Professor,

Department of Physiotherapy,

Ahmedabad Physiotherapy College,

Parul University, Gujarat, India.



This is an Open Access Journal / article distributed under the terms of the **Creative Commons Attribution License** (CC BY-NC-ND 3.0) which permits unrestricted use, distribution, and reproduction in any medium, provided the original work is properly cited. All rights reserved.

### ABSTRACT

The iliotibial band has gained recent attention as a frequently overused structure in sports, particularly among long-distance runners. The repetitive knee movements in long-distance running can lead to ITB friction, bursa inflammation, and subsequent tightness, potentially causing issues such as iliotibial band friction syndrome. The Postural Restoration Institute® proposes a novel exercise, right sidelying respiratory left adductor pull back (RSRLAPB), designed to address ITB tightness by promoting isolated muscle activation, preventing compensation, and enhancing neuromuscular function. 10 participants, aged 19-48, exhibiting left ITB tightness, were selected through convenient sampling. The Obers test was employed to evaluate ITB tightness. All the participants will receive RSRLAPB exercise along with static stretching for 3 weeks. Hip adduction range of motion will be measured using the universal goniometer, and lower extremity functionality will be assessed with the lower extremity functional scale at both baseline and post-intervention. A Statistically significant difference was observed within pre and post readings of the Left Hip Adduction ROM & LEFS Scores. Therefore, the research concluded that the combination of RSRLAPB exercise and static stretching is effective in improving hip adduction ROM and enhancing lower extremity function among long-distance runners experiencing iliotibial band tightness.





**Heli Parikh et al.,****Keywords:** Iliotibial band tightness, Right sidelying respiratory left adductor pull back exercise (RSRLAPB), Static Stretching, Long distance runners

## INTRODUCTION

The iliotibial tract, also known as Maissiat's band or the iliotibial band, is a portion of the fascia lata, a dense connective tissue that surrounds the muscles in the hip and lower extremity region. Specifically, the iliotibial tract is a robust band situated on the lateral side of the thigh. [1] Proximally, the iliotibial tract splits into superficial and deep layers, enveloping tensor fasciae latae, securing it to the iliac crest, and inserting the gluteus maximus tendon. [2] ITB originates at the anterior superior iliac spine, sharing origin with tensor fasciae latae and gluteus maximus. Extending to hip and knee, it inserts beneath the lateral knee at Gerdy's tubercle. [3] The iliotibial tract, along with its affiliated muscles, contributes to the extension, abduction, and lateral rotation of the hip. [1] Iliotibial tract aids posture, enabling asymmetrical standing. Lower attachment applies upward force, causing knee hyperextension, creating stable support pillar. [4] ITB crucial for knee stability in walking and running. Collaboration with thigh muscles ensures this vital function during movement. [3] The ITB, represents an anatomical entity located in the lateral upper leg, acquiring recent attention for its heightened prominence as an often-over utilized structure in sporting activities. [5] ITB's mechanical importance is evident in running-related injuries, with 5% to 14% prevalence. [6] ITB stabilizes the knee, abducts the hip. In knee flexion (around 30 degrees), tension causes lateral movement over the femoral condyle; during extension, it returns to its original position. [3] Knee movements generate ITB friction, potentially causing bursa inflammation. Protective response reduces range of motion, increasing likelihood of ITB tightness. [7] Long-distance running with a tight ITB intensifies friction, causing inflammation and swelling. This can lead to Iliotibial Band Friction Syndrome, characterized by lateral patella tracking and patellar compression. [8]

ITB tightness during running alters biomechanics, particularly in the stance phase, limiting adduction and negatively impacting running economy due to reduced flexibility in muscles. [9], [10] Connecting ITB tightness with iliotibial band friction syndrome is logical, as a tighter band may lead to increased compression of underlying tissues during each gait cycle. [11] ITB friction syndrome arises from extreme ITB tightness and myofascial structure restrictions, linked to compensatory mechanisms due to lateral gluteal muscle weakness and inhibition. [7] An alternative literature review suggests intrinsic factors like a constricted ITB, and weakened gluteus minimus and maximus, combined with extrinsic factors like inadequate training and footwear, contribute to ITB Friction Syndrome. [12] The assessment of individuals exhibiting tightness in the ITB can be executed using the Ober's test, with the outcomes subject to quantification through observational means. [13] To avoid ITB tightness complications, maintaining flexibility is crucial. Physical therapists have various documented methods to enhance iliotibial band flexibility in long-distance runners. [3] In the context of its administration, a number of therapeutic approaches has been listed and applied by physical therapists. These encompass cryotherapy, high voltage pulsed galvanic stimulation or iontophoresis, periods of rest or activity modification, stretching exercises, application of moist heat packs, ultrasound, and exercises to enhance ROM. [13] The Postural Restoration Institute® has introduced a novel exercise known as the right sidelying respiratory left adductor pull back (RSRLAPB). This exercise targets specific muscles to counteract inherent tendencies, integrating desired neuromuscular functionality and preventing compensatory actions, ultimately improving Ober's test measurement outcomes. [13] Limited adduction and compromised lower extremity function may result from tightness in the iliotibial band, contributing to abnormal biomechanics. [3], [14] Currently, Physical therapists employ RSRLAPB for musculoskeletal issues, but its combined efficacy with static stretching for ITB tightness lacks published research. This study investigates the impact of RSRLAPB exercises and static stretching on hip adduction ROM and lower extremity functionality in long-distance runners.



**Heli Parikh et al.,**

## MATERIALS AND METHDOLOGY

10 Long Distance Runners were assessed and selected based on the inclusion and exclusion criteria, and assigned for this pilot study.

### Inclusion criteria

Long-distance runners aged 19-48 years, both male and female, Players who provided informed consent, Presence of Left ITB tightness confirmed through a positive Ober's test. [3], [13], [15]

### Exclusion criteria

Long-distance runners with ITB tightness, any other history of lower limb injury, musculoskeletal impairments, neurological complications, or systemic illnesses, participants receiving alternative treatment interventions. [3], [13] Study objectives clearly defined. All participants gave written consent. Before inclusion, participants were advised to avoid activity, wear comfortable attire, and stay hydrated. All the Participants (n=10) received RSRLAPB along with static stretching for 3 weeks.

### Screening for ITB Tightness – ober's Test<sup>[3]</sup>

The therapist conducted the Ober's test to evaluate iliotibial band tightness. The participant, positioned in a side-lying stance, flexed the lower leg at the hip and knee for stability. The therapist then passively abducted and extended the participant's upper leg with the knee extended. By abruptly releasing the upper leg, a positive indication for iliotibial band tightness was determined if the leg remained abducted without falling on the table.

### Static Stretching<sup>[3], [13], [16]</sup>

Long-distance runners were instructed to perform active static stretching for the iliotibial band. This involved extending and adducting the affected leg across the other while exhaling and flexing the trunk laterally. 3 Repetitions were performed with 30 seconds stretch hold twice daily for 3 weeks. (Figure-1)

### RSRLAPB Exercise<sup>[13], [17]</sup>

Participants lie on the right side, feet against a wall, forming 90-degree hip and knee angles. Maintain rounded back, use a pillow. Place a bolster between feet, towel between knees, with the left knee lower than hip. Apply pressure by pushing the right foot into the wall. Inhale slowly, pull back the left leg, exhale, squeeze the left knee into the towel for 3 seconds. Inhale again, pull the left leg further back, engaging the left inner thigh. Repeat the squeezing action with each exhale for 4-5 breath cycles, aiming to extend the left leg further with each inhalation. After completing the sequence, relax the knees, and repeat the process four more times. The exercise aims to enhance flexibility and activate the left inner thigh through controlled movements and coordinated breathing. 5 Repetitions were performed (3 Inhalations + 3 Exhalations = 1 Rep), Twice Daily for 3 Weeks. (Figure-2)

### Outcome Measures

Pre and post intervention hip adduction range of motion was calculated using the universal goniometer.<sup>[3]</sup>(ICC=0.82-0.84)<sup>[18]</sup> Lower extremity functionality was measured with lower extremity functional scale at the baseline and after the intervention.<sup>[14]</sup>(ICC=0.80-0.94)<sup>[19]</sup>

## RESULTS

Statistical analysis was done by using SPSS Version 29.0 and level of significance was set at  $p < 0.05$ . Descriptive statistics was performed to assess the mean and standard deviation of the respective groups. Normality of the data was assessed using Shapiro Wilkison test. Data distribution was normal as per Shapiro wilkinson test, Hence Parametric tests are used for analysis. Regarding left hip Adduction ROM ( $P=0.015$ ) and Lower Extremity Functional



**Heli Parikh et al.,**

Scale(LEFS) ( $P<0.001$ ) Within group analysis by paired sample t test reported Statistically Significant Result. (Table 2 and 3)

## DISCUSSION

The purpose of the present study was to investigate the effectiveness of RSRLAPB exercise along with static stretching on iliotibial band tightness in long distance runners. The results of the study show that RSRLAPB exercise along with static stretching on the tight iliotibial band produced a significant difference in improving hip adduction range of motion and lower extremity functionality. Static stretching primarily centers on increasing muscle tension and enhancing muscle flexibility, resulting in improved joint range of motion. The process involves systematically elongating the musculotendinous units of the iliotibial band, leading to a sustained lengthening of the band. This, in turn, reduces the passive tension of the tight iliotibial band, ultimately enhancing the flexibility of the band. [3] In static stretching, the musculotendinous unit experiences prolonged elongation as a result of stress relaxation. [20] Static stretches slowly lengthen the muscle when it is held for 15 -30 seconds. [21] The literature recommends the use of the RSRLAPB exercise as a specific method that incorporates precise muscle positioning, two respiratory phases, and concurrent muscle activity. [22] During a positive Ober's test, if the tested leg is extended and adducted, an anteriorly tilted pelvis may cause femoral impingement, limiting adduction ROM with a hard end feel. [23] RSRLAPB repositions the acetabulum for anatomical neutrality, with relaxed paraspinal muscles in the recommended position, preventing anterior pelvic tilt.

A large pillow induces passive left hip FAIR, elongating the posterior hip capsule. [17] This movement also contributes to elongating or restraining muscles linked to the right anterior outlet (adductors, levator ani, obturator internus) and those of the left anterior inlet (rectus femoris, sartorius). [24] Additionally, this posture supports neuromuscular re-education with an expanded left diaphragm zone during inhalation. Maintaining specific positions prevents lumbar lordosis, pelvic tilt, rib elevation, or external rotation, facilitating unrestricted left hip movement, enhancing flexibility, and preventing impingement. [13] Our results align with a study of 30 participants, showing significant improvement in hip adduction after a 3-week intervention. The experimental group, with moist heat, stretching, and RSRLAPB exercise, demonstrated notable enhancement over the control group. This supports the study's indication that RSRLAPB effectively addresses limited hip adduction, corrects postural asymmetry, and establishes a normal respiratory pattern in individuals with iliotibial band tightness. [13] Another case report, involving a college football player with bilateral thoracic outlet syndrome, demonstrated parallel results. Following a 6-week RSRLAPB exercise treatment, the athlete reported a complete pain reduction and functional improvement. [24] Our findings are consistent with a study employing a comparable method (90/90 left hemibridge with balloon) for 13 individuals with lumbo-pelvic-femoral pain and a shared LAIC impairment. Following one session, participants saw a significant and clinically meaningful reduction in pain. The study suggests that the Ober's test reflects pelvic and hip joint positions, activating hamstrings and abdominals to promptly change the pelvic and hip position, leading to a negative Ober's test (enhanced hip adduction range). [23] Thus the study found that RSRLAPB exercise along with static stretching is effective on hip adduction ROM and lower extremity function in long distance runners with iliotibial band tightness.

## CONCLUSION

In conclusion, the pilot study provides preliminary evidence supporting the effectiveness of the RSRLAPB exercise in combination with static stretching for improving Left Hip Adduction ROM and lower extremity function in long-distance runners with ITB Tightness.



**Heli Parikh et al.,****Clinical Implication**

The study highlights the potential benefit of incorporating targeted exercises and stretches into the rehabilitation and training programs of long-distance runners experiencing Left ITB Tightness.

**Future Recommendations**

Further research with a larger sample size and a control group is needed to confirm and generalize these findings.

**ACKNOWLEDGEMENT**

I would like to express my sincere gratitude to the Almighty for providing me with the strength, wisdom, and perseverance to embark on this research journey. My heartfelt thanks go to my esteemed guide, Dr. Vrunda Gujjar, whose invaluable guidance, unwavering support, and insightful feedback have been instrumental in shaping this research. I extend my deepest appreciation to the Principal, HOD, Dr. Gaurav J Patel, for their encouragement and facilitation of resources. I am also immensely thankful to all the participants who willingly contributed their time and insights, making this study possible. Each of you has played a crucial role in the success of this research endeavors, and I am truly grateful for your support.

**REFERENCES**

1. Flato R, Passanante GJ, Skalski MR, Patel DB, White EA, Matcuk GR. The iliotibial tract: imaging, anatomy, injuries, and other pathology. *Skeletal radiology*. 2017 May;46:605-22.
2. Fairclough J, Hayashi K, Toumi H, Lyons K, Bydder G, Phillips N, Best TM, Benjamin M. The functional anatomy of the iliotibial band during flexion and extension of the knee: implications for understanding iliotibial band syndrome. *Journal of anatomy*. 2006 Mar;208(3):309-16.
3. Muragod A, Patil VR, Nitsure P. Immediate effects of static stretching versus myofascial release in iliotibial band tightness in long distance runners-a randomised clinical trial. *European Journal of Sports Medicine*. 2015 Jan 24;2(1).
4. Evans P. The postural function of the iliotibial tract. *Annals of the Royal college of Surgeons of England*. 1979 Jul;61(4):271.
5. Gose JC, Schweizer P. Iliotibial band tightness. *Journal of Orthopaedic & Sports Physical Therapy*. 1989 Apr;10(10):399-407.
6. Hutchinson LA, Lichtwark GA, Willy RW, Kelly LA. The iliotibial band: a complex structure with versatile functions. *Sports Medicine*. 2022 May;52(5):995-1008.
7. Fredericson M, Wolf C. Iliotibial band syndrome in runners: innovations in treatment. *Sports Medicine*. 2005 May;35:451-9.
8. Hudson Z, Darthuy E. Iliotibial band tightness and patellofemoral pain syndrome: a case-control study. *Manual therapy*. 2009 Apr 1;14(2):147-51.
9. Beaudoin CM, Blum JW. Flexibility and running economy in female collegiate track athletes. *Journal of Sports Medicine and physical fitness*. 2005 Sep 1;45(3):295.
10. Gleim GW, Stachenfeld NS, Nicholas JA. The influence of flexibility on the economy of walking and jogging. *Journal of orthopaedic research*. 1990 Nov;8(6):814-23.
11. Lavine R. Iliotibial band friction syndrome. *Current reviews in musculoskeletal medicine*. 2010 Oct;3(1-4):18-22.
12. Saikia S. Etiology, Treatment, and Prevention of Iliotibial Band Syndrome: A Literature Review. A senior research project submitted in partial requirement for the degree Doctor of Chiropractic. 2012 Feb 16;25.
13. Shori G, Joshi A. Effect of right sidelying respiratory left adductor pull back exercise in subjects with iliotibial band tightness. *Physiotherapy Quarterly*. 2017 Jan 1;25(1):13-6.
14. Allen DJ. Treatment of distal iliotibial band syndrome in a long distance runner with gait re-training emphasizing step rate manipulation. *International journal of sports physical therapy*. 2014 Apr;9(2):222.





**Heli Parikh et al.,**

15. Noble CA. Iliotibial band friction syndrome in runners. The American journal of sports medicine. 1980 Jul;8(4):232-4.
16. Fredericson M, White JJ, Macmahon JM, Andriacchi TP. Quantitative analysis of the relative effectiveness of 3 iliotibial band stretches. Archives of physical medicine and rehabilitation. 2002 May 1;83(5):589-92.
17. Boyle KL. Clinical application of the right sidelying respiratory left adductor pull back exercise. International Journal of Sports Physical Therapy. 2013 Jun;8(3):349.
18. Nussbaumer S, Leunig M, Glatthorn JF, Stauffacher S, Gerber H, Maffiuletti NA. Validity and test-retest reliability of manual goniometers for measuring passive hip range of motion in femoroacetabular impingement patients. BMC musculoskeletal disorders. 2010 Dec;11:1-1.
19. Mulligan EP, Middleton EF, Brunette M. Evaluation and management of greater trochanter pain syndrome. Physical Therapy in Sport. 2015 Aug 1;16(3):205-14.
20. Taylor DC, Dalton JR JD, Seaber AV, Garrett JR WE. Viscoelastic properties of muscle-tendon units: the biomechanical effects of stretching. The American journal of sports medicine. 1990 May;18(3):300-9.
21. Bandy WD, Irion JM. The effect of time on static stretch on the flexibility of the hamstring muscles. Physical therapy. 1994 Sep 1;74(9):845-50.
22. Boyle KL, Demske JR. Management of a female with chronic sciatica and low back pain: a case report. Physiotherapy Theory and Practice. 2009 Jan 1;25(1):44-54.
23. Tenney HR, Boyle KL, DeBord A. Influence of hamstring and abdominal muscle activation on a positive Ober's test in people with lumbopelvic pain. Physiotherapy Canada. 2013 Jan;65(1):4-11.
24. Robey JH, Boyle KL. Bilateral functional thoracic outlet syndrome in a collegiate football player. North American journal of sports physical therapy: NAJSPT. 2009 Nov;4(4):170.

**Table-1: Demographic Description of the Subjects**

GROUP (n = 10)		
AGE (Mean ± SD)	39.5 ± 5.44	
GENDER	Males	Females
	6 (60%)	4 (40%)

**Table-2: Comparison of Pre and post Hip Adduction ROM**

HIP ADDUCTION ROM	PRE	POST
Mean	9.4000	13.5000
Standard Deviation	2.27058	2.36878
p-Value	0.015	

p-value<0.05 is statistically significant

**Table-3: Comparison of Pre and Post Lower Extremity Functional Scale (LEFS)**

LEFS	Pre	Post
Mean	47.5000	61.8000
Standard Deviation	12.33108	6.97296
p-Value	<0.001	

p-value<0.05 is statistically significant





Heli Parikh et al.,



Figure-1: Static Stretching



Figure-2: RSRLAPB Exercise





## A Study of High School Teacher's Mental Health in the Tiruvanmalai District

S.Premkumar<sup>1\*</sup> and K. Sheeba<sup>2</sup>

<sup>1</sup>Research Scholar, Department of Education, Vels Institute of Science, Technology and Advanced Studies, (VISTAS), Pallavaram, (Affiliated to Vels University) Chennai, Tamil Nadu, India.

<sup>2</sup>Associate Professor, Department of Education, Vels Institute of Science, Technology and Advanced Studies, (VISTAS), Pallavaram, (Affiliated to Vels University) Chennai, Tamil Nadu, India.

Received: 22 Jan 2024

Revised: 09 Feb 2024

Accepted: 03 May 2024

### \*Address for Correspondence

**S.Premkumar**

Research Scholar,  
Department of Education,  
Vels Institute of Science,  
Technology and Advanced Studies, (VISTAS),  
Pallavaram, (Affiliated to Vels University)  
Chennai, Tamil Nadu, India.  
Email: premkumarvks76@gmail.com



This is an Open Access Journal / article distributed under the terms of the **Creative Commons Attribution License** (CC BY-NC-ND 3.0) which permits unrestricted use, distribution, and reproduction in any medium, provided the original work is properly cited. All rights reserved.

### ABSTRACT

Teaching is being considered as one of the noblest profession since ancient times. With the changing socioeconomic scenario and increasing unemployment, the values of teachers' and their professional concern with the job have forcibly undergone a drastic change which adversely affects their mental health. The level of mental health of a teacher has been found affected with numerous personal as well as professional demands. Health of teachers, on social, physical and mental health domains adds to the efficiency not only to their professional growth and development but also to their personality. Moreover, they have also been considered as the constructors of the future of a country. Keeping these facts into the consideration, present study aimed to access the level of personal mental health of Qualification and Teaching Experience High school teachers. For this multi stage random sampling technique was adopted. 150 teachers were drawn randomly from 20 randomly selected High schools of Tiruvannamalai district, Tamil Nadu State.. This survey research leads us to conclusion that Qualification and Teaching Experience affect the mental health.

**Keywords:** Mental Health, High School Teachers , Teachers group, Qualification, Teaching Experience.





## INTRODUCTION

Mental health studies have become equally important as physical health. Sigmund Freud in his definition of mental health states that it is the capacity to work and love. A good mental health motivates individuals to give off their best. According to the World Health Organization (WHO), mental health includes "subjective well-being, perceived self-efficacy, autonomy, competence, inter-generational dependence, and self actualization of one's intellectual and emotional potential, among others."The WHO further states that the well-being of an individual is encompassed in the realization of their abilities, coping with normal stresses of life, productive work and contribution to their community. Mental health in yesteryears was considered only as serious mental disorders, but now the definition is widened to even normal people experiencing symptoms of a bigger problem, thus leading to a drop in their productivity. In India, the Mental Health Act was passed on 22 May 1987. The law was described in make better provision with respect to their properly and affairs and for matters connected therewith or incidental thereto. Education leads to transformation and as teachers we are the stewards of this transformation. Teachers must enjoy good mental health so that they can deliver their best to society. Teachers work with individuals and have to train and mould them to become productive citizens of a progressive society. All this is possible if the teachers enjoy good mental health. This study was undertaken with this concern. A teacher is builder of future of any society. Even best curriculum , syllabus, methods and techniques are useless, if the teacher is not competent. If teacher is not performing effectively, the whole educational system is likely to be collapse. Many psychological factors of human personality affects the performance of teachers and mental health is one of the important factor. Teacher should be disciplined and must have a sound and positive attitude toward students. Mental health is the balance that is likely to exist between different aspects of human personality such as emotional, physical, social etc. A happy and satisfied human is said to be mentally healthy. A mentally healthy human is more fit and effective in all areas of human life. Agarwal (2007) asserted that good mental health is associated with effective organization of various abilities so as to overcome strain and stress. A teacher having sound mental set up or health can satisfy the needs of his students more effectively. He earns respect in the class and can manage various problems associated with teaching and learning easily. A Mentally healthy teacher exhibit a behavior which is desirable and do his duties more effectively. If the mental health, is better the results and output of the efforts of teacher is better

## REVIEW OF LITERATURE

**Chanderkant, Neeraj and Sandeep** (2015) Conducted study on Mental Health among Government School Teachers, results reveals that significant differences among government and private, male and female, urban and rural school teachers .Male school teachers were found better on mental health compared to female teachers. Teacher who is posted in urban had high mental health status compared to rural area teachers. **Gorsy , M.(2015)** studied Mental Health among Government School Teachers. The level of mental health of a teacher has been found affected with numerous personal as well as professional demands. The t-values reveals that significant gender differences exist among government school teachers and male school teachers were found better on mental health than their female counterparts. Additionally, teachers posted at schools located under urban area were found higher on mental health as compared to teaches posted at schools located under rural areas **Cezar –Vaz, M. (2015)** conducted a study on Mental Health of Elementary School teachers in Southern Brazil: Working Conditions and Health Consequences. There was a statistically significant association between inadequate salary and anxiety and between an excessive number of activities and stress. Teachers reported that a good relationship among colleagues in a working condition promotes well-being in the workplace. **Gonsalves, A.(2014)** studied Public school teachers" perceptions about Mental Health. Teachers" understanding of the terms "health and "mental health," was studied. The result shows from the teachers" perspective, general health is defined as the proper physiological functioning of the body and mental health is related to the balance between mind and body, as a requirement for happiness. Most of the teachers (80.6%) showed great interest in acquiring knowledge about mental health and receiving educational materials on the subject. The review revealed that there is much need for studies in Mental health for better awareness.





**Premkumar and Sheeba**

Researchers are also trying to find out more correlates to Mental health **Nandoliya , H. (2013)** conducted a study on „Mental health of higher secondary school teacher with relation to sex, habitat, types of school and faculty“. The result shows a significant difference existed between male and female teachers on mental health. A significant difference existed between urban and rural teachers on mental health. Significant difference existed among arts, commerce and science faculty“s teachers on mental health. Sex and type of school of teachers, interact with each other on mental health. **Gholamitooranposhti, M. (2012)** conducted a study on Teachers“ Mental health. The purpose of the present research is comparison of mental health normal and retarded students“ teachers. The results showed that in mental and physical scales, retarded students“ teachers showed less mental health. Also results of independent t-test showed that there are a significant difference between teachers of normal and retarded students in loneliness and fatigue scales. Also there is significant relation between religious attitude and mental health. **Maninkardan , K. (2012)** studied occupational mental health of school and college teachers.. An attempt has been made in this study to find out whether sex and institution influences occupational mental health of teachers. Sex and institution has significant main and interaction effects on certain components of occupational mental health but not on the total occupational mental health **Chan et al (2010)** conducted a study to assess the stress level among primary and secondary school teachers in Hong kong. A questionnaire was used for the purpose of data collection. SPSS was used to analyze the data. In the sample of 1710 teachers, 907 were primary and 803 were secondary school teachers. The results indicated that gender and job experience has no role to play in mental **Dewan et al. (2009)** examined the effects of gender, religion and marital status upon mental health of tribal school teachers in Jharkhand.

A stratified random sample of 400 tribal school teachers was selected for the study. Results revealed that gender produces significant effects on mental health. Female teachers as compared to male teachers were found to show poor mental health. The main effects of religion on mental health were found to be significant. **Srivastava and Khan (2008)** conducted a study to know the impact of mental health on the level of burnout of the teachers teaching at different education level. They concluded that teachers with low mental health are more prone to burnouts than the teachers of average and high mental health. **Kaur (2007)** investigates occupational stress, mental health and coping resources of high and higher secondary school teachers and their relationship. The results revealed that sometimes teachers feel stressed due to role overload, responsibilities and physical stressors present in school. Whereas, teachers those who are mentally healthy use coping resources to combat the effect of occupational stress. They use recreational activities such as watching T.V., listening music, getting social support from friends to relief from mental tensions, etc. The result also indicated that correlation between occupational stress and mental health is negative. Occupational stress and coping resources also tends to be negative. Correlation between mental health and coping resources is positive and significant **Ngidi & Sibaya (2002)** in South Africa revealed that inexperienced teachers are under more stress as compare to experienced teachers and sex has no role to play in mental stress, where as studies conducted by (Jepson & Forrest, 2006) revealed that experience and gender has no relation with mental stress. **Kamau (1992)** investigated the problem of burn out in relation the locus of control mental health among teachers. Results revealed that male teachers were emotionally over extended exhausted, internally controlled, anxious, cool towards students and personally accomplished but less capable of establishing constructive relationship, however, they were more capable of, coping with stresses than female teachers **Anand (1996-97)** studied the effect of mental health status on occupational stress of higher secondary school teacher. Result indicated that as mental health status improved decreased **Anand (1986)** reported a study on mental health of school teachers using a mental health scale and observed that 59% of teachers were mentally healthy. The state of working bears no relations to mental health while social values were positively related to mental health of teachers, religious values were negatively related.

**OBJECTIVES**

The present study has been conducted on High School Teachers of Tiruvannamalai district (T.N.). The focus of present study revolves around important issue of life i.e. mental health among High School Teachers . The objectives of the study are as follows:

1. To compare the mental health on Qualification in High School Teachers.
2. To compare the mental health on Teaching Experience of High School Teachers





**Premkumar and Sheeba**

**RESEARCH HYPOTHESIS**

- There is no significant difference among High School Teachers with different Qualification in their level Mental Health in total and its dimensions.
- There is no significant difference among High School Teachers with different Teaching Experience in their level of Mental Health in total and its dimensions.

**POPULATION AND SAMPLE OF THE STUDY**

**Population:** The population for the study was made up of all 150 teachers in the 6<sup>th</sup>, 7<sup>th</sup> and 8<sup>th</sup> Standards at all 20 High schools in the Tiruvannamalai District.

**Sample:** Using a random selection technique, 150 High School Teachers were chosen for the study. Survey method is adopted. Data is collected from both male and female High School Teachers at both rural and urban locality.

**ANALYSIS AND INTERPRETATION OF DATA**

H<sub>1</sub>; H<sub>1</sub>: There is no significant difference among High School Teachers with different Qualification in their level Mental Health in total and its dimensions.

H<sub>2</sub>: There is no significant difference among High School Teachers with different Length of Teaching Experience in their level of Mental Health in total and its dimensions.

**FINDINGS OF THE STUDY**

- The High School Teachers with different Qualification shows statistically significant difference in their overall Mental Health level.
- The High School Teachers with different Teaching Experience show statistically no significant difference in their total Mental Health level and in its five dimensions –Emotional Balance, Adjustment Behaviour and Independent Behaviour, Self Structure, Intrinsic. Whereas, they do not show any significant differences in one dimension of Mental Health namely Teaching Experience

**RECOMMENDATION**

In the light of the conclusions drawn, the following recommendations are at this moment offered by the researcher:

1. Teachers should maintain a healthy wellness lifestyle, particularly 7 to 9 hours of sleep, to have a healthy mind and body
2. Teachers may engage in wellness programs (e.g., yoga, Zumba, etc.) to better improve their mental attitude towards work.
3. Teachers should develop tolerating gestures and reframed self-management skills to better handle challenge situations.
4. Continuous development of quality, accessible, contextualized, and timely learning resources based on the latest trends in education, particularly this time of new normal, is encouraged.
5. Schools should establish a teachers' service center (TSC) to provide psychosocial assistance and mental health awareness.
6. School heads and educational leaders should have concrete programs on wellness, fitness, and lifestyle well-being of teachers and personnel to maintain a healthy lifestyle and positive mind set at work
7. Education Program Supervisors may use this study as a springboard to develop their programs and adopt this strategy to develop learning resources fastened by higher-order thinking skills content or activity-lesson-assessment (ALA) for the higher academic performance of learners.

**CONCLUSION**

Awareness surrounding teacher mental health is growing; however, more could be done to mitigate the mental health challenges and support those who are struggling. The dominate narrative is that we need to monitor and



**Premkumar and Sheeba**

improve the mental health and wellbeing of teachers because it may affect the mental health and wellbeing of students. Instead, the narrative needs to change to reflect the fact that teacher mental health is human mental health. In addition to individual stress interventions at the worker level, systemic changes are needed to mitigate teacher stress. Teachers require emotional support, mental health resources, and healthy relationships with administrators and school boards. School climate affects everyone in the school, so more training needs to be provided to the leadership team in each school. The scoping review reveals that mental health, leaves of absences, and return-to-work are understudied among teachers and therefore deserve further research. In addition, the role of gender and care and their relationship to teacher mental health remain understudied in the literature. COVID-19 continues to pose a range of challenges to educators and has added more stress to an already high-stress profession. Now, more than ever, we need to support teachers as they adapt to ensure learning can continue both during and post-pandemic. Although individual mental health strategies can be effective in supporting some educators, a multi-layered approach is necessary in order to target systemic changes in the education sector. Focusing on organizational- and systemic-level strategies to improve teacher mental health has the ability to create long-lasting changes that teachers deserve. There was a significant difference in mental health status of high school teachers, it shows that the qualification of the High School Teachers had higher mental health status than the Teaching Experience of the teachers. The government high school teacher had high mental health status than the private high school teachers. Teacher are our nation builder, the strength of every profession in our country grow out of the knowledge and skills that teachers helps to instill in our children. The teachers' mental health is directly related to the work of classroom. Thus good mental health of the teacher should as important qualification as academic competence

**REFERENCES**

1. Kinman, G.; Wray, S.; Strange, C. Emotional labour, burnout and job satisfaction in UK teachers: The role of workplace social support. *Educ. Psychol.* 2011, 31, 843–856. [CrossRef]
2. Naghieh, A.; Montgomery, P.; Bonell, C.P.; Thompson, M.; Aber, J.L. Organisational interventions for improving wellbeing and reducing work-related stress in teachers. *Cochrane Database Syst. Rev.* 2015, 4, CD010306. [CrossRef] [PubMed]
3. Kaihoi, C.A.; Bottiani, J.H.; Bradshaw, C.P. Teachers Supporting Teachers: A Social Network Perspective on Collegial Stress Support and Emotional Wellbeing Among Elementary and Middle School Educators. *Sch. Ment. Health* 2022. [CrossRef] [PubMed]
4. Ekornes, S. Teacher stress related to student mental health promotion: The match between perceived demands and competence to help students with mental health problems. *Scand. J. Educ. Res.* 2017, 61, 333–353. [CrossRef]
5. Yang, R.; You, X.; Zhang, Y.; Lian, L.; Feng, W. Teachers' mental health becoming worse: The case of China. *Int. J. Educ. Dev.* 2019, 70, 102077. [CrossRef]
6. Shami, R.; Tare, M.; Taran, H. Identifying the relationship among teacher's mental health and emotional intelligence and their burnout. *Indep. J. Manag. Prod.* 2017, 8, 124–143. [CrossRef]
7. Diener, E.; Suh, E.M.; Lucas, R.E.; Smith, H.L. Subjective well-being: Three decades of progress. *Psychol. Bull.* 1999, 125, 276. [CrossRef]
8. Sun, P.; Fan, X.; Sun, Y.; Jiang, H.; Wang, L. Relations between dual filial piety and life satisfaction: The mediating roles of individuating autonomy and relating autonomy. *Front. Psychol.* 2019, 10, 2549. [CrossRef]
9. Karasek Jr, R.A. Job demands, job decision latitude, and mental strain: Implications for job redesign. *Adm. Sci. Q.* 1979, 285–308. [CrossRef]
10. Bandura, A. Human agency in social cognitive theory. *Am. Psychol.* 1989, 44, 1175. [CrossRef]
11. Dreison, K.C.; White, D.A.; Bauer, S.M.; Salyers, M.P.; McGuire, A.B. Integrating self-determination and job demands-resources theory in predicting mental health provider burnout. *Adm. Policy Ment. Health Ment. Health Serv. Res.* 2018, 45, 121–130. [CrossRef] [PubMed]





## Premkumar and Sheeba

12. Han, K.-M.; Shin, C.; Yoon, H.-K.; Ko, Y.-H.; Kim, Y.-K.; Han, C. Emotional labor and depressive mood in service and sales workers: Interactions with gender and job autonomy. *Psychiatry Res.* 2018, 267, 490–498. [CrossRef] [PubMed]

Table 1:

Dimensions of Mental Health	Qualification			F value	P Value
	UG with B.Ed	PG with B.Ed	PG with M.Ed		
Emotional Balance	28.99 <sup>a</sup> (2.725)	30.63 <sup>a</sup> (0.471)	32.84 <sup>b</sup> (1.918)	32.328	0.000
Adjustment Behaviour	21.87 <sup>a</sup> (3.324)	24.27 <sup>a</sup> (3.922)	25.68 <sup>b</sup> (2.832)	7.802	0.001
Independent Behaviour	30.18 <sup>a</sup> (4.239)	32.32 <sup>a</sup> (2.932)	31.56 <sup>b</sup> (2.283)	7.371	0.001
Self Structure	34.04 <sup>a</sup> (4.728)	39.13 <sup>a</sup> (2.644)	36.82 <sup>b</sup> (3.401)	5.468	0.005
Instinct	32.26 <sup>a</sup> (3.774)	33.67 <sup>a</sup> (2.713)	36.56 <sup>a</sup> (3.683)	0.316	0.659
Overall Mental Health Total	<b>161.01<sup>a</sup></b> <b>(13.668)</b>	<b>154.17<sup>b</sup></b> <b>(11.791)</b>	<b>147.89<sup>b</sup></b> <b>(4.858)</b>	<b>4.423</b>	<b>0.012</b>

Table 2:

Dimensions of Mental Health	Teaching Experience			F value	P Value
	Below 5 Years	6 – 12 Yrs	Above 13 Yrs		
Emotional Balance	32.56 <sup>ab</sup> (2.755)	34.37 <sup>b</sup> (2.163)	36.204 <sup>a</sup> (2.622)	2.843	0.064
Adjustment Behaviour	25.16 <sup>a</sup> (2.669)	26.89 <sup>b</sup> (2.963)	21.81 <sup>ab</sup> (3.535)	2.201	0.94
Independent Behaviour	30.31 <sup>a</sup> (3.668)	33.62 <sup>a</sup> (2.923)	34.79 <sup>a</sup> (3.910)	0.297	0.682
Self Structure	35.44 <sup>a</sup> (5.050)	33.12 <sup>a</sup> (2.772)	39.68 <sup>a</sup> (4.071)	0.638	0.468
Instinct	36.67 <sup>a</sup> (3.947)	34.61 <sup>b</sup> (2.273)	33.72 <sup>b</sup> (3.540)	6.756	0.002
Overall Mental Health Total	<b>146.04<sup>a</sup></b> <b>(9.414)</b>	<b>141.97<sup>b</sup></b> <b>(9.102)</b>	<b>127.25<sup>b</sup></b> <b>(13.250)</b>	<b>2.107</b>	<b>0.085</b>





## Evaluation of Antioxidant and Anthelmintic Activity of *Senna alata* (L.) Roxb.

Suman Pattanayak<sup>1</sup>, Surajit Maity<sup>2</sup>, Subhas Sahoo<sup>3</sup>, Amit Maity<sup>4</sup>, Subhadip Ghosh<sup>4</sup>, Subhranil Mandal<sup>4</sup> and Lakshmi Kanta Kanthal<sup>5\*</sup>

<sup>1</sup>Principal and Professor, Department of Pharmacy, Haldia Institute of Pharmacy, Haldia, (Affiliated to West Bengal University of Health Sciences), West Bengal, India.

<sup>2</sup>Associate Professor, Department of Pharmacy, Haldia Institute of Pharmacy, Haldia, (Affiliated to West Bengal University of Health Sciences), West Bengal, India.

<sup>3</sup>Professor, Department of Pharmacy, Pulla Reddy Institute of Pharmacy, (Affiliated to Jawaharlal Nehru Technological University, Hyderabad) Hyderabad, Telangana India.

<sup>4</sup>Student, B.Pharm 4<sup>th</sup> Year, Department of Pharmacy, Haldia Institute of Pharmacy, Haldia, (Affiliated to West Bengal University of Health Sciences), West Bengal, India.

<sup>5</sup>Professor and Vice Principal, Department of Pharmacology, Haldia Institute of Pharmacy, Haldia, (Affiliated to West Bengal University of Health Sciences), West Bengal, India.

Received: 10 Jan 2024

Revised: 09 Feb 2024

Accepted: 26 Apr 2024

### \*Address for Correspondence

**Lakshmi Kanta Kanthal**

Professor and Vice Principal,  
Department of Pharmacology,  
Haldia Institute of Pharmacy, Haldia,  
(Affiliated to West Bengal University of Health Sciences),  
West Bengal, India.

Email: lkkhaldia@gmail.com



This is an Open Access Journal / article distributed under the terms of the **Creative Commons Attribution License** (CC BY-NC-ND 3.0) which permits unrestricted use, distribution, and reproduction in any medium, provided the original work is properly cited. All rights reserved.

### ABSTRACT

The current study aims to assess the antioxidant and anthelmintic properties of leaves of *Senna alata* (L.) Roxb. The concentration range evaluated was from 20 to 100 g/ml, and the antioxidant activity was calculated as a percentage of scavenging. *Senna alata* leaves were examined for *in vitro* anthelmintic action on *Pheritima posthuma* (Indian adult earthworms) at three different concentrations (25, 50, and 100 mg/ml). By using the DPPH assay (2, 2-diphenyl-1-picrylhydrazyl), the percentage of scavenging (for 20 to 100 g/ml) was determined to be from 49.30 to 89.67% (IC<sub>50</sub> value 34.08). Earth worms could be paralyzed for 21 to 34 minutes using *Senna alata* and for 9 to 15 minutes using Albendazole whereas Indian earth worms could die in 35 to 50 minutes using *Senna alata* and in 14 to 22 minutes using Albendazole. *Senna alata* is therefore recommended as an antioxidant and an anthelmintic medicine in the pharmacy research field and can be established as a novel medicinal property-containing substance, as shown by the results.





Suman Pattanayak et al.,

**Keywords:** Antioxidant, Anthelmintic, *Pheritima posthuma*, DPPH, *Senna alata*,

## INTRODUCTION

In tropical and humid settings, *Senna alata*, a member of the Leguminosae family, is widely distributed. According to numerous research, *S. alata* has a wide range of therapeutic advantages, such as antibacterial, antidiabetic, antilipogenic, antifungal, antioxidant, dermatophytic, anti-hyperlipidemic, and anthelmintic properties [1]. Food and the human body naturally contain antioxidants. These substances are crucial for preventing the oxidative cell death that occurs when free radical generation damages cells [2]. A disorder known as helminthiasis occurs when the body has been infected by tapeworms, pinworms, and roundworms. Although the worms often reside in the gastrointestinal tract, they can burrow into the liver and other organs to gain access to them [3]. Furthermore, estimates show that helminth infections, which are transmitted through the soil, affect more than a billion people, largely in underdeveloped countries [4,5]. Helminthic infection is a significant problem in cattle productivity and a serious threat to the world's food security. The only real method of helminth control is a few handfuls of synthetic anthelmintic drugs [6]. Assam, Kerala, Uttar Pradesh, West Bengal, Bongaigaon, Barak Valley, Sivasagar, and Lakhimpur are among the places where *Senna alata* is grown [1]. The literature review found that the phenolic and flavonoid content of the *Senna* genus, which includes compounds like catechins, proanthocyanidins, scutellarein, rutin, quercimeritrin, kaempferol glycosides, rhein, chrysophanol, aloe-emodin, and physcion, contributes to the plant's antioxidant activity [4]. Determining the antioxidant and anthelmintic properties of a methanolic extract of *Senna alata* (L.) Roxb. leaves are the purpose of the current investigation.

## MATERIALS AND METHODS

### Collection and authentication of plant materials

*Senna alata* leaves were gathered in May 2022 from several locations in Haldia, Purba Medinipur Dist., West Bengal, and verified by the scientist in charge of the Central National Herbarium at the Botanical Survey of India, Kolkata, West Bengal. The Department of Pharmacognosy at the Haldia Institute of Pharmacy in Haldia, Purba Medinipur, West Bengal, India, developed and kept the plant herbarium. The carefully chosen plant materials were prepared by cold maceration process where 350 ml of methanol were used to extract 137 g of powdered dry leaves, which were then filtered. The extract is then dried and stored for further use.

### Preliminary Phytochemical tests

The methanolic extracts were examined for Phlobatannin, alkaloids, glycosides, saponins, steroids, terpenoids, phenols, tannins, and flavonoids [7-9].

### In-vitro Antioxidant Activity

#### Principle

The 2, 2-Diphenyl-1-picrylhydrazyl (DPPH) is a free radical that is stable (in powder form) and has a red hue that changes to yellow when it is scavenged. The equation  $(DPPH) + (H-A) \rightarrow DPPH-H + (A)$  describes the reaction between (DPPH) and an antioxidant (H-A). Antioxidants convert DPPH to DPPH-H by a reaction, which lowers absorbance. The degree of discoloration reveals the antioxidant compounds' or extracts' scavenging capacity in terms of hydrogen-donating capacity [10].

#### Preparation of DPPH standard solution

Ethanol (100 ml) and DPPH (4 mg) were combined, then the mixture was sealed with aluminium foil and incubated for 30 minutes.





Suman Pattanayak et al.,

**Preparation of control solution**

Six (6) ml of ethanol and 4 ml of DPPH standard solution were combined before being sealed with aluminium foil and incubated for 30 minutes.

**Preparation of Ascorbic acid standard solution**

100 ml of distilled water and 100 mg of ascorbic acid were combined to create a standard stock solution with a 1000 g/ml concentration. Five different concentrations of the standard solution were made from the aforementioned solution. With ethanol (100 g/ml), the DPPH standard solution's volume was made up to 10 ml. Following that, all five of the aforementioned standard solution concentrations were left in a dark area for 30 minutes.

**Preparation of test sample solution**

The *Senna alata* plant extract weighing 100 mg was combined with 100 ml of ethanol at a concentration of 1000 g/ml as a sample stock solution. Five solutions of varying concentrations (20 g/ml, 40 g/ml, 60 g/ml, 80 g/ml, and 100 g/ml) were made from the aforementioned solution. Following that, all five of the aforementioned sample solutions were left in a dark area for 30 minutes.

**Experimental procedure for Anti-oxidant activity**

Standard ascorbic acid solutions and various concentrations of plant extracts were incubated for 30 minutes at room temperature in a dark area. A 518 nm absorbance was measured after 30 minutes. The following formula was used to determine how effective plant extract and ascorbic acid solution were at scavenging free radicals.

The percentage inhibition for scavenging activity = (Absorbance of control- Absorbance of sample)/Absorbance of control × 100

**In vitro Anthelmintic activity****Earthworm's collection**

The evaluation of *Senna alata* leaf methanolic extract's anthelmintic activity was done using adult *Pheritima posthuma* (Indian earthworms). The earthworms were gathered from Haldia, Purba Medinipur, West Bengal's damp soil. Worms were cleaned with saline water before being placed in Tyrode solution for storage. Worms that were between 0.2 and 0.3 cm broad and roughly 9 cm long were chosen for the experiment.

**Preparation of Tyrode solution**

The following materials were accurately weighed: NaCl (8.0g), KCl (0.2g), Ca (0.2g), Mg (0.1g), NaH<sub>2</sub>PO<sub>4</sub> (0.05g), NaHCO<sub>3</sub> (1.0g), and glucose (1.0g). To make up the volume of 1000 ml, combine all the ingredients with a small amount of water until everything were dissolved.

**Experimental Procedure**

On the *Pheritima posthuma* (Indian earth worm), the anthelmintic activity was carried out in accordance with the recommended techniques<sup>11, 12</sup>. The three concentrations of the standard drug sample, 25, 50, and 100mg/mL concentrations, were generated by diluting the standard medication i.e., Albendazole with normal saline solution and then adding them to the petridishes. *Senna alata* leaf methanolic extract was diluted to produce concentrations of 25, 50, and 100 mg/ml, respectively by using the ordinary saline solution. The negative control was just plain saline (0.9% NaCl) solution. As a result, all of these dilutions were added to the petridishes. Seven petridishes of identical size were taken and numbered. Then, six earthworms (n=6) of a similar size (≥ 9 cm) were inserted in each petridish at room temperature. Then, all petridishes were watched, and the paralysis and death (lethal) times were noted down. Minutes were used to calculate the paralysis and fatal times. The anthelmintic procedures were carried out for three times.

**Analysis**

The investigation into when paralysis and death in earthworms occur was done after the anthelmintic screening. Paralysis was noted when there was no movement or a loss of movement (not recoverable even in normal saline),





Suman Pattanayak et al.,

and death was noted when there was no movement even after being shaken violently and dipped in 500°C warm water and having the colour of the worm fade.

#### Statistical analysis

Mean± SEM were used to express the results. One-way analysis of variance (ANOVA) was used to analyze the total variation.

## RESULTS AND DISCUSSION

#### Preliminary Phytochemical evaluation

According to preliminary phytochemical analyses of *Senna alata* methanolic extract (leaves), there are no proteins or amino acids and only alkaloids, carbohydrates, glycosides, saponins, tannins, flavonoids, steroids, and terpenoids present (Table 1).

#### In-vitro Antioxidant activity

By calculating the percentage of scavenging, the antioxidant activity of *Senna alata* methanolic extract and Ascorbic acid (standard) was determined. The concentration range was evaluated between 20 and 100 g/ml. Scavenging percentage for the 20 to 100 g/ml range ranged from 49.30 to 89.67%. (34.08% for the IC50) (Table 2) (Figure 1).

#### In-vitro Anthelmintic activity

*Senna alata* leaf methanolic extract was evaluated for anthelmintic action against adult *Pheritima posthuma* Indian earthworms at various concentrations. Table 3 displays the paralysis and mortality times in relation to albendazole. When tested at various concentrations of these extracts and standard drug ranging from 25 to 100mg/ml, the paralysis time of earth worms ranged from 21 minutes to 34 minutes for *Senna alata*, and 09 minutes to 15 minutes for albendazole, whereas the death time of earth worms ranged from 35 minutes to 50 minutes for *Senna alata*, and 14 minutes to 22 minutes for albendazole, respectively. When compared to the albendazole, the earth worms' paralysis and time to death were significantly longer. (Table 3) (Figure 2-4). As the concentration of the extracts and albendazole were increased against *Pheritima posthuma*, there was a considerable reduction in the paralysis time and death time.

## CONCLUSION

*Senna alata* (leaves) methanolic plant extract has been shown to have anti-inflammatory and anthelmintic properties. Due to the presence of numerous key phytoconstituents as saponins, tannin, flavonoids, terpenoids, etc., the research plant demonstrated significant antioxidant activity. The *Senna alata* can therefore be helpful in the treatment of diseases caused by free radicals or oxidative stress like helminthiasis.

#### CONFLICT OF INTEREST

None.

#### ACKNOWLEDGEMENT

The authors are thankful to the Management of Haldia Institute of Pharmacy, Haldia, Purba Medinipur Dist.-721657, West Bengal, India for availing all the facilities.







Suman Pattanayak et al.,

## REFERENCES

1. Oladeji OS, Adelowo FE, Oluyori AP, Bankole DT. Ethnobotanical Description and Biological Activities of *Senna alata*. Evid Based Complement Alternat Med. 2020; 2020: 12.
2. Bagchi K and Puri S. Free radicals and antioxidants in health and disease: a review. Eastern Mediterranean Health Journal. 1998; 4 (2): 350-360.
3. Raju N and Yesuf, Elias and Bekele, Mihreteab and Wabe, Nasir. Investigation of In Vitro Anthelmintic Activity of *Ficus vasta* leaves. Asian Journal of Pharmaceutical and Biological Research. Asian J Pharm Bio Res.2011; Vol. 1(4):454-458.
4. Sri Fatmawati, Yuliana, Adi Setyo Purnomo, Mohd Fadzelly Abu Bakar. Chemical constituents, usage and pharmacological activity of *Cassia alata*, Heliyon, 2020; Volume 6, Issue 7.
5. Keiser J, Utzinger J. Efficacy of current drugs against soil-transmitted helminth infections: systematic review and meta-analysis. JAMA. 2008 Apr 23;299(16):1937-48.
6. Williams A R, Ropiak H M, Frygnas C. et al. Assessment of the anthelmintic activity of medicinal plant extracts and purified condensed tannins against free-living and parasitic stages of *Oesophagostomum dentatum*. Parasites and Vectors, 2014; 7, 518.
7. Singchai B, Kansane K, Chourykaew B. Phytochemical screening and biological activities of *Borassus flabellifer* L. Asian J pharm Clin Res. 2015;8(3):151-3.
8. Harborne JB. Phytochemical methods - a guide to modern techniques of plant analysis. 2nd ed. London: Chapman and Hall. 1984; 4-16.
9. Muthukumar A, Jothi D, Manohar M, Rajasingh SR, Peraman M, Nachimuthu S. In-vitro studies on phytochemical evaluation and antimicrobial activity of *Borassus flabellifer* Linn against some human pathogens. Asian Pac J Tropical Med. 2014; 7(1):182-5.
10. Tailor C S, Goyal A. Antioxidant activity by DPPH Radical Scavenging Method of *Ageratum conyzoides* Linn. Leaves, American Journal of Ethanomedicine, 2014; 1: 244-249
11. Ghosh T, Maity TK, Boseand A, Dash GK. Athelmintic activity of *Bacopamonierr*. Indian J Nat Prod.,2005,21;16-9
12. Rastogi T, Bhutda V, Moon K, Aswar PB, Khadabadi SS. Comparative studies on anthelmintic activity of *Moringa oleifera* and *Viitex negundo*. Asian J Res Chem;2009,2;181-2.

**Table1: Result of preliminary phytochemical tests of methanolic extract of *Senna alata* for the presence of various metabolites**

Type of phytochemical constituent	Name of the tests	Methanolic extract of <i>Sennaalata</i>
Test for alkaloid	Mayer's test	Present
	Wagner test	Present
Test for carbohydrate	Molish's test	Present
	Fehling's test	Present
Test for glycosides	Brontrager's test	Present
	Killer-killani test	Present
Test for saponins	Foam test	Present
Test for phenol	Ferric chloride test	Present
Test for tannin	Lead acetate test	Present
Test for flavonoids	Alkaline reagent test	Present
Test for proteins and amino acid	Ninhydrin test	Absent
Test for steroids and terpenoids	Salkowski test	Present





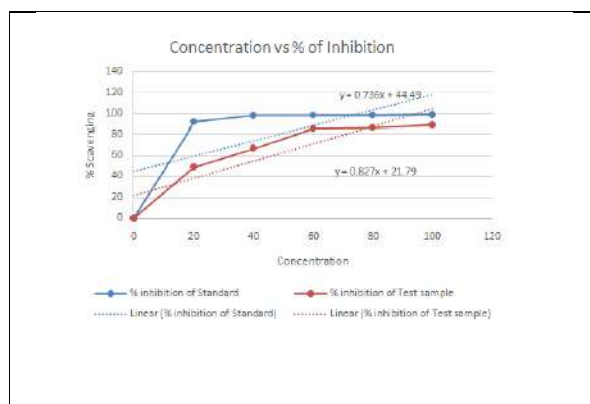
**Suman Pattanayak et al.,**

**Table 2: Result for in-vitro antioxidant activity of *Senna alata* (leaves) extract**

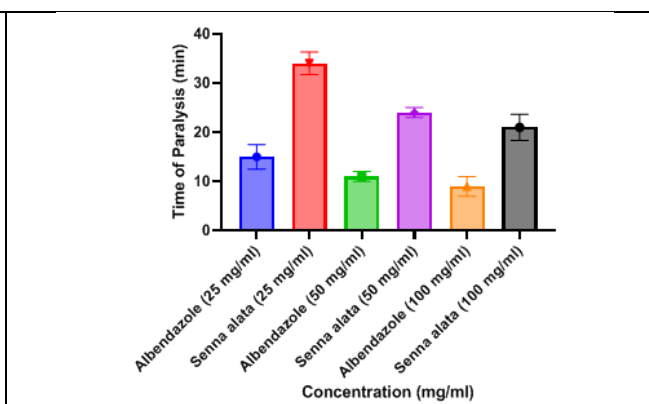
Sl.No.	Concentration(µg/ml)	Percentage(%)inhibition of <i>Sennaalata</i> extract	Percentage(%) inhibition of Ascorbic acid
1	20	49.30	92.52
2	40	67.37	98.62
3	60	85.90	98.67
4	80	86.78	98.72
5	100	89.67	99.38
IC <sub>50</sub>		34.08	07.47

**Table 3: Result of anthelmintic effect of methanolic extract of *Senna alata* leaves against *Pheritima posthuma***

Treatment	Concentration(mg/ml)	Paralysis time (min)	Death time(min)
Albendazole	25	15±2.5	22±5.0
	50	11±1.0	17±4.5
	100	09±2.0	14±3.08
<i>Sennaalata</i> (extract)	25	34±2.3	50±3.05
	50	24±1.0	40±4.0
	100	21±2.64	35±1.5
Control (Salinesolution)	0.9%Nacl	No paralysis	No death



**Figure 1: Graphical representation for in-vitro antioxidant activity of methanolic extract of *Senna alata*.**

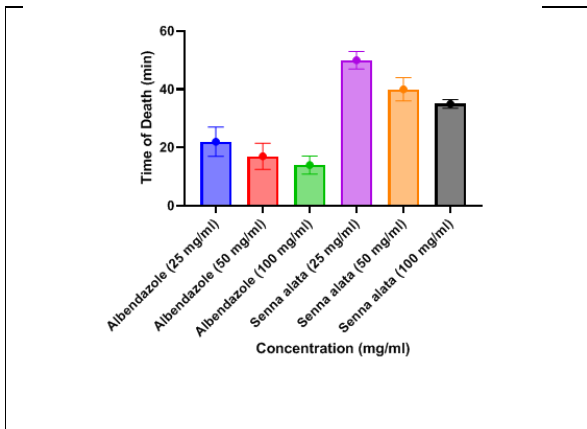


**Figure 2: Comparative paralysis time of earth worms treated methanolic extract of *Senna alata*leaves and the standard drug (Albendazole)**

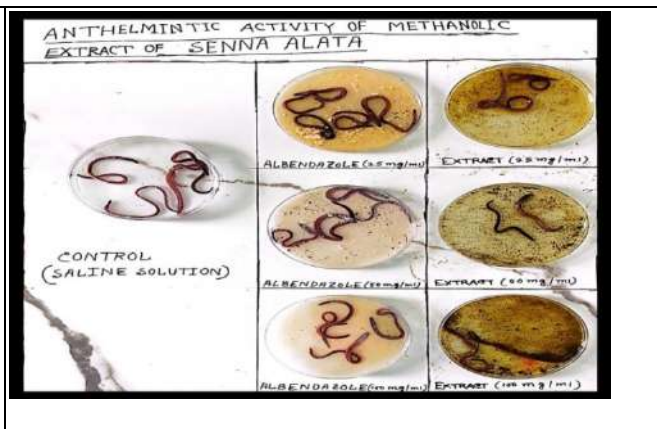




**Suman Pattanayak et al.,**



**Figure 3: Comparative death time of earth worms treated extracts of *Senna alata* leaves and the standard drug (Albendazole)**



**Figure 4: Typical images of earth worms treated to methanolic extracts of *Senna alata* leaves and various concentrations of the albendazole.**





## g-Inverse of Interval Valued Intuitionistic Fuzzy Matrices

A.Venkatesh<sup>1</sup> and S. Chanthirababu<sup>2\*</sup>

<sup>1</sup>Assistant Professor, Department of Mathematics, A.V.V.M Sri Pushpam College, Poondi, Thanjavur, (Affiliated to Bharathidasan University, Tiruchirappalli) Tamil Nadu, India (ORCID ID: 0000-0002-8011-421)

<sup>2</sup>Research Scholar, Department of Mathematics, A.V.V.M Sri Pushpam College, Poondi, Thanjavur, (Affiliated to Bharathidasan University, Tiruchirappalli) Tamil Nadu, India (ORCID ID: 0009-0000-4707-6908)

Received: 12 Feb 2024

Revised: 12 Apr 2024

Accepted: 22 May 2024

### \*Address for Correspondence

**S. Chanthirababu**

Research Scholar,

Department of Mathematics,

A.V.V.M Sri Pushpam College, Poondi, Thanjavur,

(Affiliated to Bharathidasan University, Tiruchirappalli),

Tamil Nadu, India.

Email: scbtr1@gmail.com



This is an Open Access Journal / article distributed under the terms of the **Creative Commons Attribution License** (CC BY-NC-ND 3.0) which permits unrestricted use, distribution, and reproduction in any medium, provided the original work is properly cited. All rights reserved.

### ABSTRACT

The g-Inverses of Interval Valued Intuitionistic Fuzzy Matrices (IVIFM), which are a generalization of the g-Inverses of Interval Valued Regular Fuzzy Matrices, have been covered in this article. In terms of the row and column spaces, the existence and construction of g-inverses,  $\{1,2\}$ ,  $\{1,3\}$  and  $\{1,4\}$  inverses of an IVIFM are established. Also, we study Left k-regular and Right k-regular for IVIFM.

**Keywords:** IFM, k – regular IFM, IVIFM, Generalized Inverse.

### INTRODUCTION

We work with g-inverse of interval-valued Intuitionistic fuzzy matrices, or IVIFMs, which are matrices with interval entries that are all subintervals of the interval  $[0, 1]$ . If  $X$  exists such that  $PXP = P$ , then a matrix  $P \in (IVIFM)_{mn}$  is said to be regular.  $X$  is known as a generalized inverse of  $P$  and is represented by  $P^-$ . Kim and Roush [1] have studied generalized fuzzy matrices. Meenakshi and Kaliraja [2] have discussed Regular Interval Valued Fuzzy Matrices. Meenakshi and Jenita [3] have focused on Generalized Regular Fuzzy Matrices. Shyamal and Pal [4] have studied Interval Valued Fuzzy Matrices. Thomason [5] discussed Convergence of powers of fuzzy matrix. Meenakshi [6] has studied Fuzzy Matrix Theory and Applications. Shyamal and Pal [7] have discussed Interval Valued Fuzzy Matrices. Meenakshi and Kaliraja [8] have discussed Regular Interval Valued Fuzzy Matrices. Ben Israel and Greville [9] have studied Generalized Inverses.





**Venkatesh and Chanthirababu**

In this paper, as a generalization of regular IVIFM and as an extension of  $k - r$  fuzzy matrix, we introduce the idea of  $k - r$  regular IVIFM .The  $g$ -Inverses of IVIFM which are a generalization of the  $g$ -Inverses of Interval Valued Regular Fuzzy Matrices, have been covered . In terms of the row and column spaces, the existence and construction of  $g$ -inverses,  $\{1,2\}$ ,  $\{1,3\}$  and  $\{1,4\}$  inverses of an interval valued fuzzy matrix are established. The row and column ranks of a  $k - r$  regular IVIFM are determined.Meenakshi,AR &Kaliraja [10] have present  $g$ -Inverses of Interval Valued Fuzzy Matrices

**Research Gap**

Meenakshi & Kaliraja [10] presented the concept of  $g$ -Inverses of Interval Valued Fuzzy Matrices. We have applied the  $g$ -inverse of IVIFM in this context. We have examined some of the results and extended concepts to IFMs. We first present The  $g$ -Inverses of IVIFM, which are a generalization of the  $g$ -Inverses of Interval Valued Regular Fuzzy Matrices.

**Notations:**

- $[P_{\mu L}, P_{\nu L}]^T$  = Transpose of the matrix  $[P_{\mu L}, P_{\nu L}]$ ,
- $[P_{\mu U}, P_{\nu U}]^T$  = Transpose of the matrix  $[P_{\mu U}, P_{\nu U}]$ ,
- $[P_{\mu L}, P_{\nu L}]^+$  = Moore-penrose inverse of  $[P_{\mu L}, P_{\nu L}]$ ,
- $[P_{\mu U}, P_{\nu U}]^+$  = Moore-penrose inverse of  $[P_{\mu U}, P_{\nu U}]$ ,
- $R([P_{\mu L}, P_{\nu L}])$  = Row space of  $[P_{\mu L}, P_{\nu L}]$ ,
- $R([P_{\mu U}, P_{\nu U}])$  = Row space of  $[P_{\mu U}, P_{\nu U}]$ ,
- $C([P_{\mu L}, P_{\nu L}])$  = Column space of  $[P_{\mu L}, P_{\nu L}]$ ,
- $C([P_{\mu U}, P_{\nu U}])$  = Column space of  $[P_{\mu U}, P_{\nu U}]$ ,
- $Qr([P_{\mu L}, P_{\nu L}])$  = Row rank of  $[P_{\mu L}, P_{\nu L}]$ ,
- $Qr([P_{\mu U}, P_{\nu U}])$  = Row rank of  $[P_{\mu U}, P_{\nu U}]$ ,
- $Qc([P_{\mu L}, P_{\nu L}])$  = Column rank of  $[P_{\mu L}, P_{\nu L}]$ ,
- $Qc([P_{\mu U}, P_{\nu U}])$  = Column rank of  $[P_{\mu U}, P_{\nu U}]$ ,
- $k$ -regular =  $k-r$
- Right  $k$ -regular =  $R-k-r$
- Regular = Reg

**PRELIMINARIES AND DEFINITIONS**

**Definition:2.1** (IVIFM): An IVIFM  $P$  of order  $m \times n$  is defined as  $P = [X_{ij}, \langle p_{ij\mu}, p_{ij\nu} \rangle]_{m \times n}$  where  $p_{ij\mu}$  and  $p_{ij\nu}$  are both the subsets of  $[0,1]$  which are denoted by  $p_{ij\mu} = [p_{ij\mu L}, p_{ij\mu U}]$  and  $p_{ij\nu} = [p_{ij\nu L}, p_{ij\nu U}]$  which maintaining the condition  $0 \leq p_{ij\mu U} + p_{ij\nu U} \leq 1, 0 \leq p_{ij\mu L} + p_{ij\nu L} \leq 1, 0 \leq p_{\mu L} \leq p_{\mu U} \leq 1, 0 \leq p_{\nu L} \leq p_{\nu U} \leq 1$  for  $i = 1, 2, \dots, m$  and  $j = 1, 2, \dots, n$ .

**Example 2.1** Let us consider IVIFM

$$P = \begin{bmatrix} \langle [0.4, 0.4], [0.5, 0.5] \rangle & \langle [0.3, 0.4], [0.4, 0.5] \rangle \\ \langle [0.4, 0.6], [0.3, 0.4] \rangle & \langle [0.4, 0.6], [0.4, 0.5] \rangle \end{bmatrix},$$

Lower limit IFM





**Venkatesh and Chanthirababu**

$$[P_{\mu L}, P_{\nu L}] = \begin{bmatrix} \langle 0.4, 0.4 \rangle & \langle 0.3, 0.4 \rangle \\ \langle 0.4, 0.6 \rangle & \langle 0.4, 0.6 \rangle \end{bmatrix}$$

Upper limit IFM

$$[P_{\mu U}, P_{\nu U}] = \begin{bmatrix} \langle 0.5, 0.5 \rangle & \langle 0.4, 0.5 \rangle \\ \langle 0.3, 0.4 \rangle & \langle 0.4, 0.5 \rangle \end{bmatrix}$$

**Definition 2.2** For  $P \in (IVIFM)_n$  is said to be right  $k - r$  if there exist a  $IVIFM X \in (IVIFM)_n$ , such that  $P^k X P = P^k$ , for some positive integer  $k$ .  $X$  is called a right  $k - g$  inverse of  $P$ .

Let  $P_r\{1^k\} = \{X / P^k X P = P^k\}$ .

**Definition 2.3** For  $P \in (IVIFM)_n$  is said to be left  $k - r$  if there exist a  $IVIFM Y \in (IVIFM)_n$ , such that  $PYP^k = P^k$ , for some positive integer  $k$ .  $Y$  is called a left  $k - g$  inverse of  $P$ .

Let  $P_l\{1^k\} = \{Y / P Y P^k = P^k\}$ .

**Theorem 2.1** For  $P = \langle [P_{\mu L}, P_{\nu U}], [P_{\mu L}, P_{\nu U}] \rangle \in IVIFM_{mn}$  and  $Q = \langle [Q_{\mu L}, Q_{\nu U}], [Q_{\mu L}, Q_{\nu U}] \rangle \in IVIFM_{mn}$  the following hold.

- (i)  $P^T = \langle [P_{\mu L}, P_{\nu L}]^T, [P_{\mu U}, P_{\nu U}]^T \rangle$
- (ii)  $PQ = \langle [P_{\mu L}, P_{\nu L}][Q_{\mu L}, Q_{\nu L}], [P_{\mu U}, P_{\nu U}][Q_{\mu U}, Q_{\nu U}] \rangle$

**Theorem 2.2** (Theorem 3.7 [8]) For  $P$  and  $Q$  belongs to  $(IVIFM)_{mn}$

- (i)  $R(PQ) \subseteq R(P)$
- (ii)  $C(PQ) \subseteq C(Q)$

**Theorem 2.3** Let  $P = \langle [P_{\mu L}, P_{\nu U}], [P_{\mu L}, P_{\nu U}] \rangle$  be an  $IVIFM_{mn}$ . Then,

- (i)  $R(P) = \langle R[P_{\mu L}, P_{\nu L}], R[P_{\mu U}, P_{\nu U}] \rangle \in (IVIFM)_{1n}$
- (ii)  $C(P) = \langle C[P_{\mu L}, P_{\nu L}], C[P_{\mu U}, P_{\nu U}] \rangle \in (IVIFM)_{1m}$

**Theorem 2.4** (Theorem 3.7 [8]) For  $P$  and  $Q$  belongs to  $(IVIFM)_{mn}$

- (iii)  $R(Q) \subseteq R(P) \Leftrightarrow Q = WP$  for some  $W \in (IVIFM)_m$
- (iv)  $C(Q) \subseteq C(P) \Leftrightarrow Q = PY$  for some  $Y \in (IVIFM)_n$

**Proof:** Let  $P = \langle [P_{\mu L}, P_{\nu L}], [P_{\mu U}, P_{\nu U}] \rangle$  and  $Q = \langle [Q_{\mu L}, Q_{\nu L}], [Q_{\mu U}, Q_{\nu U}] \rangle$

Since  $Q = WP$  for some  $W \in (IVIFM)_m$

Let  $W = \langle [W_{\mu L}, W_{\nu L}], [W_{\mu U}, W_{\nu U}] \rangle$ .

$$[Q_{\mu L}, Q_{\nu L}] = [W_{\mu L}, W_{\nu L}][P_{\mu L}, P_{\nu L}]$$

$$[Q_{\mu U}, Q_{\nu U}] = [W_{\mu U}, W_{\nu U}][P_{\mu U}, P_{\nu U}]$$

Therefore by Theorem 2.2,

$$R([Q_{\mu L}, Q_{\nu L}]) \subseteq R([P_{\mu L}, P_{\nu L}]) \text{ and}$$

$$R([Q_{\mu U}, Q_{\nu U}]) \subseteq R([P_{\mu U}, P_{\nu U}])$$





$$R(Q) = (R[Q_{\mu L}, Q_{\nu L}], R[Q_{\mu U}, Q_{\nu U}])$$

$$\subseteq (R[P_{\mu L}, P_{\nu L}], R[P_{\mu U}, P_{\nu U}]) = R(P).$$

Thus  $R(Q) \subseteq R(P)$ .

Contrariwise,  $R(Q) \subseteq R(P)$

$$\Rightarrow R([Q_{\mu L}, Q_{\nu L}]) \subseteq R([P_{\mu L}, P_{\nu L}])$$

$$R([Q_{\mu U}, Q_{\nu U}]) \subseteq R([P_{\mu U}, P_{\nu U}])$$

$[Q_{\mu L}, Q_{\nu L}] = Y[P_{\mu L}, P_{\nu L}]$  and  $[Q_{\mu U}, Q_{\nu U}] = Z[P_{\mu U}, P_{\nu U}]$  (By Theorem (2.2))

Then  $Q = \langle [Q_{\mu L}, Q_{\nu L}], [Q_{\mu U}, Q_{\nu U}] \rangle$

$$= \langle Y[P_{\mu L}, P_{\nu L}], Z[P_{\mu U}, P_{\nu U}] \rangle$$

$$= [Y, Z] \langle [P_{\mu L}, P_{\nu L}], [P_{\mu U}, P_{\nu U}] \rangle$$

$$= W \langle [P_{\mu L}, P_{\nu L}], [P_{\mu U}, P_{\nu U}] \rangle$$

$$= WP$$

$$Q = WP$$

**Generalized Regular IVIFM**

**Theorem 3.1:** Let  $P = \langle [P_{\mu L}, P_{\nu L}], [P_{\mu U}, P_{\nu U}] \rangle \in \text{IVIFM}_n$  then  $P$  is left  $k$  – regular IVIFM  $\Leftrightarrow [P_{\mu L}, P_{\nu L}]$

and  $[P_{\mu U}, P_{\nu U}] \in (\text{IVIFM})_n$  are left  $k$  – r.

**Proof:** Let  $P = \langle [P_{\mu L}, P_{\nu L}], [P_{\mu U}, P_{\nu U}] \rangle \in \text{IVIFM}_n$

Since  $P$  is right  $k$  – r IVIFM, there exists  $W \in (\text{IVIFM})_n$ ,

then  $P^k WP = P^k$

Let  $W = \langle [W_{\mu L}, W_{\nu L}], [W_{\mu U}, W_{\nu U}] \rangle \in \text{IVIFM}_n$

Then by Lemma (2.3) (ii),

$$P^k XP = ([P_{\mu L}, P_{\nu L}], [P_{\mu U}, P_{\nu U}])^k ([W_{\mu L}, W_{\nu L}], [W_{\mu U}, W_{\nu U}]) ([P_{\mu L}, P_{\nu L}], [P_{\mu U}, P_{\nu U}])$$

$$= ([P_{\mu L}, P_{\nu L}], [P_{\mu U}, P_{\nu U}])^k$$

$$([P_{\mu L}, P_{\nu L}]^k, [P_{\mu U}, P_{\nu U}]^k) ([W_{\mu L}, W_{\nu L}], [W_{\mu U}, W_{\nu U}]) ([P_{\mu L}, P_{\nu L}], [P_{\mu U}, P_{\nu U}])$$

$$= ([P_{\mu L}, P_{\nu L}]^k, [P_{\mu U}, P_{\nu U}]^k)$$

$$([P_{\mu L}, P_{\nu L}]^k [W_{\mu L}, W_{\nu L}], [P_{\mu L}, P_{\nu L}], [P_{\mu U}, P_{\nu U}]^k [W_{\mu U}, W_{\nu U}], [P_{\mu U}, P_{\nu U}])$$

$$= ([P_{\mu L}, P_{\nu L}]^k, [P_{\mu U}, P_{\nu U}]^k)$$

$$[P_{\mu L}, P_{\nu L}]^k [W_{\mu L}, W_{\nu L}] [P_{\mu L}, P_{\nu L}] = [P_{\mu L}, P_{\nu L}]^k$$

$$[P_{\mu U}, P_{\nu U}]^k [W_{\mu U}, W_{\nu U}] [P_{\mu U}, P_{\nu U}] = [P_{\mu U}, P_{\nu U}]^k$$

Therefore  $[P_{\mu L}, P_{\nu L}]$  is R-k-r

and  $[P_{\mu U}, P_{\nu U}]$  is R-k-r  $\in (\text{IVIFM})_n$ .

Thus  $P$  is R-k-rIVIFM  $\Rightarrow [P_{\mu L}, P_{\nu L}]$





**Venkatesh and Chanthirababu**

$[P_{\mu U}, P_{\nu U}] \in (IVIFM)_n$  are R-k-r.

Contrariwise,

Let  $[P_{\mu L}, P_{\nu L}]$  and  $[P_{\mu U}, P_{\nu U}] \in (IVIFM)_n$  are R-k-r,

then  $[P_{\mu L}, P_{\nu L}]^k [W_{\mu L}, W_{\nu L}] [P_{\mu L}, P_{\nu L}] = [P_{\mu L}, P_{\nu L}]^k$

$[P_{\mu U}, P_{\nu U}]^k [W_{\mu U}, W_{\nu U}] [P_{\mu U}, P_{\nu U}] = [P_{\mu U}, P_{\nu U}]^k$  forseveral

$[W_{\mu L}, W_{\nu L}], [W_{\mu U}, W_{\nu U}] \in (IVIFM)_n$ .

$[W_{\mu L}, W_{\nu L}] \in (P_L)_r \{1^k\}, [W_{\mu U}, W_{\nu U}] \in (P_U)_r \{1^k\}$ .

Since  $[P_{\mu L}, P_{\nu L}] \leq [P_{\mu U}, P_{\nu U}]$ ,

The option to select at least one exists.

$V \in (P_L)_r \{1^k\}$ , and  $S \in (P_U)_r \{1^k\}$ .

like that  $V \leq S$ .

The IVIFM shall be defined.

$Z = [V, S]$ .

Then by Lemma(2.3)(ii),

$$P^k ZP = ([P_{\mu L}, P_{\nu L}]^k, [P_{\mu U}, P_{\nu U}]^k) \vee S ([P_{\mu L}, P_{\nu L}], [P_{\mu U}, P_{\nu U}])$$

$$P^k ZP = ([P_{\mu L}, P_{\nu L}]^k \vee [P_{\mu L}, P_{\nu L}], [P_{\mu U}, P_{\nu U}]^k \vee [P_{\mu U}, P_{\nu U}])$$

$$P^k ZP = ([P_{\mu L}, P_{\nu L}]^k, [P_{\mu U}, P_{\nu U}]^k)$$

$$P^k ZP = P^k$$

Thus P is R k – r IVIFM.

Hence proved.

**Theorem 3.2** Let  $P = \langle [P_{\mu L}, P_{\nu L}], [P_{\mu U}, P_{\nu U}] \rangle \in IVIFM_n$  and k be a positive integer, then the subsequent holds.

if  $W = \langle [W_{\mu L}, W_{\nu L}], [W_{\mu U}, W_{\nu U}] \rangle \in P_r \{1^k\}$

then  $\rho_c([P_{\mu L}, P_{\nu L}]^k) = \rho_c([P_{\mu L}, P_{\nu L}]^k [W_{\mu L}, W_{\nu L}])$ ,

$$\rho_c([P_{\mu U}, P_{\nu U}]^k) = \rho_c([P_{\mu U}, P_{\nu U}]^k [W_{\mu U}, W_{\nu U}])$$

$$\rho_r([P_{\mu L}, P_{\nu L}]^k) \leq \rho_c([W_{\mu L}, W_{\nu L}] [P_{\mu L}, P_{\nu L}]) \leq \rho_c([P_{\mu L}, P_{\nu L}]),$$

$$\rho_r([P_{\mu U}, P_{\nu U}]^k) \leq \rho_r([W_{\mu U}, W_{\nu U}] [P_{\mu U}, P_{\nu U}]) \leq \rho_r([P_{\mu U}, P_{\nu U}])$$

if  $W \in P_r \{1^k\}$  then  $\rho_c(P^k) = \rho_c(P^k W)$  and  $\rho_c(P^k) \leq \rho_r(W P) \leq \rho_r(P)$

if  $W = \langle [W_{\mu L}, W_{\nu L}], [W_{\mu U}, W_{\nu U}] \rangle \in P_r \{1^k\}$

then  $\rho_r([P_{\mu L}, P_{\nu L}]^k) = \rho_r([W_{\mu L}, W_{\nu L}] [P_{\mu L}, P_{\nu L}]^k)$ ,

$$\rho_r([P_{\mu U}, P_{\nu U}]^k) = \rho_r([W_{\mu U}, W_{\nu U}] [P_{\mu U}, P_{\nu U}]^k)$$

$$\rho_c([P_{\mu L}, P_{\nu L}]^k) \leq \rho_c([P_{\mu L}, P_{\nu L}] [W_{\mu L}, W_{\nu L}]) \leq \rho_c([P_{\mu L}, P_{\nu L}]),$$

$$\rho_c([P_{\mu U}, P_{\nu U}]^k) \leq \rho_c([P_{\mu U}, P_{\nu U}] [W_{\mu U}, W_{\nu U}]) \leq \rho_c([P_{\mu U}, P_{\nu U}])$$







**Venkatesh and Chanthirababu**

if  $W \in P_r \{1^k\}$  then  $\rho_r(P^k) = \rho_r(WP^k)$  and

$$\rho_c(P^k) \leq \rho_c(PW) \leq \rho_c(P)$$

**Proof:** Let  $P = \langle [P_{\mu L}, P_{\nu L}], [P_{\mu U}, P_{\nu U}] \rangle \in \text{IVIFM}_n$

Since  $W = \langle [W_{\mu L}, W_{\nu L}], [W_{\mu U}, W_{\nu U}] \rangle \in P_r \{1^k\}$

By Definition(3.1) and Theorem (2.3)(ii),

$$[P_{\mu L}, P_{\nu L}]^k [W_{\mu L}, W_{\nu L}] [P_{\mu L}, P_{\nu L}] = [P_{\mu L}, P_{\nu L}]^k$$

$$[P_{\mu U}, P_{\nu U}]^k [W_{\mu U}, W_{\nu U}] [P_{\mu U}, P_{\nu U}] = [P_{\mu U}, P_{\nu U}]^k$$

$$C([P_{\mu L}, P_{\nu L}]^k) = C([P_{\mu L}, P_{\nu L}]^k [W_{\mu L}, W_{\nu L}] [P_{\mu L}, P_{\nu L}])$$

$$\subseteq C([P_{\mu L}, P_{\nu L}]^k [W_{\mu L}, W_{\nu L}]) \subseteq C([P_{\mu L}, P_{\nu L}]^k) \dots \dots \dots \text{(i)}$$

and  $C([P_{\mu U}, P_{\nu U}]^k) = C([P_{\mu U}, P_{\nu U}]^k [W_{\mu U}, W_{\nu U}] [P_{\mu U}, P_{\nu U}])$

$$\subseteq C([P_{\mu U}, P_{\nu U}]^k [W_{\mu U}, W_{\nu U}]) \subseteq C([P_{\mu U}, P_{\nu U}]^k) \dots \dots \dots \text{(ii)}$$

$$\rho_c([P_{\mu L}, P_{\nu L}]^k) = \rho_c([P_{\mu L}, P_{\nu L}]^k [W_{\mu L}, W_{\nu L}])$$

$$\rho_c([P_{\mu U}, P_{\nu U}]^k) = \rho_c([P_{\mu U}, P_{\nu U}]^k [W_{\mu U}, W_{\nu U}])$$

Since,  $[P_{\mu L}, P_{\nu L}]^k [W_{\mu L}, W_{\nu L}] [P_{\mu L}, P_{\nu L}] = [P_{\mu L}, P_{\nu L}]^k$

$$[P_{\mu U}, P_{\nu U}]^k [W_{\mu U}, W_{\nu U}] [P_{\mu U}, P_{\nu U}] = [P_{\mu U}, P_{\nu U}]^k$$

We have  $[P_{\mu L}, P_{\nu L}]^k = [P_{\mu L}, P_{\nu L}]^k [W_{\mu L}, W_{\nu L}] [P_{\mu L}, P_{\nu L}]$

$$= [P_{\mu L}, P_{\nu L}]^k ([W_{\mu L}, W_{\nu L}] [P_{\mu L}, P_{\nu L}])^2 = \dots = [P_{\mu L}, P_{\nu L}]^k ([W_{\mu L}, W_{\nu L}] [P_{\mu L}, P_{\nu L}])^k$$

$$[P_{\mu U}, P_{\nu U}]^k = [P_{\mu U}, P_{\nu U}]^k [W_{\mu U}, W_{\nu U}] [P_{\mu U}, P_{\nu U}]$$

$$= [P_{\mu U}, P_{\nu U}]^k ([W_{\mu U}, W_{\nu U}] [P_{\mu U}, P_{\nu U}])^2 = \dots = [P_{\mu U}, P_{\nu U}]^k ([W_{\mu U}, W_{\nu U}] [P_{\mu U}, P_{\nu U}])^k$$

Therefore,  $[P_{\mu L}, P_{\nu L}]^k = [P_{\mu L}, P_{\nu L}]^k ([W_{\mu L}, W_{\nu L}] [P_{\mu L}, P_{\nu L}])^k$ , (By Theorem 2.2)

$$R([P_{\mu L}, P_{\nu L}]^k) = R([P_{\mu L}, P_{\nu L}]^k ([W_{\mu L}, W_{\nu L}] [P_{\mu L}, P_{\nu L}])^k) \subseteq R([W_{\mu L}, W_{\nu L}] [P_{\mu L}, P_{\nu L}])^k$$

$$\subseteq R([W_{\mu L}, W_{\nu L}] [P_{\mu L}, P_{\nu L}]) \subseteq R([P_{\mu L}, P_{\nu L}])$$

Hence,  $R([P_{\mu L}, P_{\nu L}]^k) \subseteq R([W_{\mu L}, W_{\nu L}] [P_{\mu L}, P_{\nu L}]) \subseteq R([P_{\mu L}, P_{\nu L}])$

$$\rho([P_{\mu L}, P_{\nu L}]^k) \subseteq \rho_r([W_{\mu L}, W_{\nu L}] [P_{\mu L}, P_{\nu L}]) \subseteq \rho_r([P_{\mu L}, P_{\nu L}])$$

Similarly,  $R([P_{\mu U}, P_{\nu U}]^k) = R([P_{\mu U}, P_{\nu U}]^k ([W_{\mu U}, W_{\nu U}] [P_{\mu U}, P_{\nu U}])^k)$

$$\subseteq R([W_{\mu U}, W_{\nu U}] [P_{\mu U}, P_{\nu U}])^k$$

$$\subseteq R([W_{\mu U}, W_{\nu U}] [P_{\mu U}, P_{\nu U}]) \subseteq R([P_{\mu U}, P_{\nu U}])$$





**Venkatesh and Chanthirababu**

$$\text{Hence, } R([P_{\mu U}, P_{\nu U}]^k) \subseteq R([W_{\mu U}, W_{\nu U}][P_{\mu U}, P_{\nu U}]) \subseteq R([P_{\mu U}, P_{\nu U}])$$

$$\rho([P_{\mu U}, P_{\nu U}]^k) \subseteq \rho_r([W_{\mu U}, W_{\nu U}][P_{\mu U}, P_{\nu U}]) \subseteq \rho_r([P_{\mu U}, P_{\nu U}]).$$

Thus(i) holds.

Since  $P = \langle [P_{\mu L}, P_{\nu L}], [P_{\mu U}, P_{\nu U}] \rangle \in \text{IVIFM}_n$

From (i) and (ii)

$$\begin{aligned} C(P^k) &= C([P_{\mu L}, P_{\nu L}]^k, [P_{\mu U}, P_{\nu U}]^k) \\ &= (C([P_{\mu L}, P_{\nu L}]^k), C([P_{\mu U}, P_{\nu U}]^k)) \\ &= (C([P_{\mu L}, P_{\nu L}]^k [W_{\mu L}, W_{\nu L}]), C([P_{\mu U}, P_{\nu U}]^k [W_{\mu U}, W_{\nu U}])) \\ &= C(P^k W) \end{aligned}$$

$$\text{and } \rho_c(P^k) = \rho_c(P^k W)$$

Similarly, From(i) and (ii)

$$\begin{aligned} R(P^k) &= R([P_{\mu L}, P_{\nu L}]^k, [P_{\mu U}, P_{\nu U}]^k) \\ &= (R([P_{\mu L}, P_{\nu L}]^k), R([P_{\mu U}, P_{\nu U}]^k)) \\ &\subseteq (R([W_{\mu L}, W_{\nu L}][P_{\mu L}, P_{\nu L}]^k), R([W_{\mu U}, W_{\nu U}][P_{\mu U}, P_{\nu U}]^k)) \\ &\subseteq (R([W_{\mu L}, W_{\nu L}][P_{\mu L}, P_{\nu L}]^k), R([W_{\mu U}, W_{\nu U}][P_{\mu U}, P_{\nu U}]^k)) \\ &\subseteq (R([P_{\mu L}, P_{\nu L}]^k), R([P_{\mu U}, P_{\nu U}]^k)) = R(P) \end{aligned}$$

$$\text{Therefore, } R(P^k) \subseteq R(WP) \subseteq R(P)$$

$$\rho_r(P^k) \leq \rho_r(WP) \leq \rho_r(P). \text{ Thus (ii) holds.}$$

The proof was omitted because it is related to that of (i).

The proof was omitted because it is related to that of (ii).

**g-inverse of IVIFM**

**Definition 4.1** For  $P = \langle [P_{\mu L}, P_{\nu L}], [P_{\mu U}, P_{\nu U}] \rangle \in \text{IVIFM}_{mn}$  if there exists  $W \in (\text{IVIFM})_{nm}$  such that

$$(i) [P_{\mu L}, P_{\nu L}] W [P_{\mu L}, P_{\nu L}] = [P_{\mu L}, P_{\nu L}],$$

$$[P_{\mu U}, P_{\nu U}] W [P_{\mu U}, P_{\nu U}] = [P_{\mu U}, P_{\nu U}],$$

$$(ii) \times [P_{\mu L}, P_{\nu L}] W = W,$$

$$W [P_{\mu U}, P_{\nu U}] W = W,$$

$$(iii) ([P_{\mu L}, P_{\nu L}] W)^T = ([P_{\mu L}, P_{\nu L}] W),$$

$$([P_{\mu U}, P_{\nu U}] W)^T = ([P_{\mu U}, P_{\nu U}] W),$$

$$(iv) (W [P_{\mu L}, P_{\nu L}])^T = (W [P_{\mu L}, P_{\nu L}]),$$

$$(W [P_{\mu U}, P_{\nu U}])^T = (W [P_{\mu U}, P_{\nu U}]),$$





**Venkatesh and Chanthirababu**

then  $W$  is called a  $g$ -inverse of  $P = \langle [P_{\mu L}, P_{\nu L}], [P_{\mu U}, P_{\nu U}] \rangle \in \text{IVIFM}_{mn}$ .

**Theorem: 4.1** Let  $P = \langle [P_{\mu L}, P_{\nu L}], [P_{\mu U}, P_{\nu U}] \rangle \in \text{IVIFM}_{mn}$  and  $W \in P\{1\}$ , then  $W \in P\{2\}$  if and only if  $R(PW) = R(W)$

**Proof:** Let  $P = \langle [P_{\mu L}, P_{\nu L}], [P_{\mu U}, P_{\nu U}] \rangle$  and  $W = \langle [W_{\mu L}, W_{\nu L}], [W_{\mu U}, W_{\nu U}] \rangle$

$$\begin{aligned} W \in P\{2\} &\Rightarrow WPW = W, \\ &\Rightarrow [W_{\mu L}, W_{\nu L}][P_{\mu L}, P_{\nu L}][W_{\mu L}, W_{\nu L}] = [W_{\mu L}, W_{\nu L}] \\ &[W_{\mu U}, W_{\nu U}][P_{\mu U}, P_{\nu U}][W_{\mu U}, W_{\nu U}] = [W_{\mu U}, W_{\nu U}] \\ &\Rightarrow [W_{\mu L}, W_{\nu L}] \in [P_{\mu L}, P_{\nu L}]\{2\} \\ &[W_{\mu U}, W_{\nu U}] \in [P_{\mu U}, P_{\nu U}]\{2\} \\ &\Rightarrow [P_{\mu L}, P_{\nu L}] \in [W_{\mu L}, W_{\nu L}]\{1\} \\ &[P_{\mu U}, P_{\nu U}] \in [W_{\mu U}, W_{\nu U}]\{1\} \\ &\Rightarrow R([W_{\mu L}, W_{\nu L}]) = R([P_{\mu L}, P_{\nu L}][W_{\mu L}, W_{\nu L}]) \\ &R([W_{\mu U}, W_{\nu U}]) = R([P_{\mu U}, P_{\nu U}][W_{\mu U}, W_{\nu U}]) \\ &\Rightarrow R(PW) = R(W) \quad (\text{By Theorem (2.4)}) \end{aligned}$$

On the other hand,

Let  $R(PW) = R(W)$ , then by Theorem(2.4),  $R(W) \subseteq R(PW) \Rightarrow W = ZPW$

for several  $Z \in (\text{IVIFM})_m$ .

$$W(PW) = (ZPW)(PW)$$

$$WAW = Z(PWP)W$$

$$= ZPW = W \quad (\text{By Definition (3.1)})$$

Thus  $W \in P\{2\}$ .

**Theorem: 4.2** Let  $P = \langle [P_{\mu L}, P_{\nu L}], [P_{\mu U}, P_{\nu U}] \rangle \in \text{IVIFM}_{mn}$ ,  $P$  has  $\{1,3\}$  inverse iff  $P^T P$  is a Reg IVIFM and  $R(P^T P) = R(P)$ .

**Proof:** Since  $P$  is Reg, Theorem (2.4),

$[P_{\mu L}, P_{\nu L}]$  and  $[P_{\mu U}, P_{\nu U}]$  are Reg.

Let  $P$  has a  $\{1,3\}$  inverse  $X$  (say)

then by equation (3) has  $\{1,3\}$  inverse  $[W_{\mu L}, W_{\nu L}]$  and  $[P_{\mu U}, P_{\nu U}]$  has a  $\{1,3\}$  inverse of  $[W_{\mu U}, W_{\nu U}]$ .

$$\text{Now } [P_{\mu L}, P_{\nu L}][W_{\mu L}, W_{\nu L}][P_{\mu L}, P_{\nu L}] = [P_{\mu L}, P_{\nu L}]$$

$$([P_{\mu L}, P_{\nu L}][W_{\mu L}, W_{\nu L}])^T = [P_{\mu L}, P_{\nu L}][W_{\mu L}, W_{\nu L}]$$

$$[P_{\mu L}, P_{\nu L}]^T ([P_{\mu L}, P_{\nu L}][W_{\mu L}, W_{\nu L}][P_{\mu L}, P_{\nu L}]) = [P_{\mu L}, P_{\nu L}]^T [P_{\mu L}, P_{\nu L}]$$

$$([P_{\mu L}, P_{\nu L}]^T [P_{\mu L}, P_{\nu L}][W_{\mu L}, W_{\nu L}]) ([P_{\mu L}, P_{\nu L}]) = [P_{\mu L}, P_{\nu L}]^T [P_{\mu L}, P_{\nu L}]$$

$$R([P_{\mu L}, P_{\nu L}]^T [P_{\mu L}, P_{\nu L}]) \subseteq R([P_{\mu L}, P_{\nu L}]) \quad (\text{By Theorem (2.2)})$$

$$\text{Similarly, } R([P_{\mu U}, P_{\nu U}]^T [P_{\mu U}, P_{\nu U}]) \subseteq R([P_{\mu U}, P_{\nu U}])$$

Therefore by Equation (3) we have,  $R(P^T P) \subseteq R(P)$





Venkatesh and Chanthirababu

$$\begin{aligned}
 &\text{Also, } ([P_{\mu L}, P_{\nu L}][W_{\mu L}, W_{\nu L}])^T [P_{\mu L}, P_{\nu L}] \\
 &= [P_{\mu L}, P_{\nu L}][W_{\mu L}, W_{\nu L}][P_{\mu L}, P_{\nu L}] \\
 &\Rightarrow ([W_{\mu L}, W_{\nu L}])^T ([P_{\mu L}, P_{\nu L}])^T [P_{\mu L}, P_{\nu L}] = [P_{\mu L}, P_{\nu L}] \\
 &\Rightarrow ([W_{\mu L}, W_{\nu L}])^T \left( ([P_{\mu L}, P_{\nu L}])^T [P_{\mu L}, P_{\nu L}] \right) = [P_{\mu L}, P_{\nu L}] \\
 &R([P_{\mu L}, P_{\nu L}]) \subseteq R\left( ([P_{\mu L}, P_{\nu L}])^T [P_{\mu L}, P_{\nu L}] \right) \quad \text{(By Theorem (2.2))}
 \end{aligned}$$

$$\text{Similarly, } R([P_{\mu U}, P_{\nu U}]) \subseteq R\left( ([P_{\mu U}, P_{\nu U}])^T [P_{\mu U}, P_{\nu U}] \right).$$

By equation (3) we must,  $R(P) \subseteq R(P^T P)$ .

Therefore,  $R(P) = R(P^T P)$ .

Subsequently  $\chi \in P\{1\}$ ,  $R(P) = R(\chi P)$ .

Hereafter,  $R(P^T P) = R(P) = R(\chi A)$ .

Subsequently  $R(P^T P) \supseteq R(\chi A)$

(By Theorem (2.5))

$$ZP^T P = \chi P \text{ let } Z = \langle [Z_{\mu L}, Z_{\nu L}], [Z_{\mu U}, Z_{\nu U}] \rangle$$

Then

$$\begin{aligned}
 &([P_{\mu L}, P_{\nu L}])^T [P_{\mu L}, P_{\nu L}] \left( [Z_{\mu L}, Z_{\nu L}] ([P_{\mu L}, P_{\nu L}])^T [P_{\mu L}, P_{\nu L}] \right) \\
 &= ([P_{\mu L}, P_{\nu L}])^T [P_{\mu L}, P_{\nu L}] [X_{\mu L}, X_{\nu L}] [P_{\mu L}, P_{\nu L}] \\
 &\left( ([P_{\mu L}, P_{\nu L}])^T [P_{\mu L}, P_{\nu L}] \right) [Z_{\mu L}, Z_{\nu L}] \left( ([P_{\mu L}, P_{\nu L}])^T [P_{\mu L}, P_{\nu L}] \right) \\
 &= ([P_{\mu L}, P_{\nu L}])^T ([P_{\mu L}, P_{\nu L}] [X_{\mu L}, X_{\nu L}] [P_{\mu L}, P_{\nu L}]) \\
 &= ([P_{\mu L}, P_{\nu L}])^T [P_{\mu L}, P_{\nu L}]
 \end{aligned}$$

$$\begin{aligned}
 &\text{Similarly, } ([P_{\mu U}, P_{\nu U}])^T [P_{\mu U}, P_{\nu U}] \left( [Z_{\mu U}, Z_{\nu U}] ([P_{\mu U}, P_{\nu U}])^T [P_{\mu U}, P_{\nu U}] \right) \\
 &= ([P_{\mu U}, P_{\nu U}])^T [P_{\mu U}, P_{\nu U}]
 \end{aligned}$$

we have,  $P^T P (ZP^T P) = P^T P$

Thus  $P^T P$  is a Reg IVIFM.

On the other hand, let  $P^T P$  be an interval-valued, Reg, IFM and  $R(P) = R(P^T P)$ .

(By Theorem (2.3))

$P$  is a Reg IVIFM.

Let us take  $Z = (P^T)^- P^T \in (IFIFM)$ .

To prove that  $Y \in P\{1, 3\}$ .

$R(P) = R(P^T P)$  and  $P^T P$  is Reg

$$\text{By Theorem (2.3) } P = P(P^T P)^- P^T P = PZP, Z \in P\{1\}$$

And since  $R(P) = R(P^T P)$ ,  $P = \chi P^T P$ ,

(By Theorem (2.4))

$$[P_{\mu L}, P_{\nu L}] = [W_{\mu L}, W_{\nu L}] ([P_{\mu L}, P_{\nu L}])^T [P_{\mu L}, P_{\nu L}]$$

$$[P_{\mu U}, P_{\nu U}] = [W_{\mu U}, W_{\nu U}] ([P_{\mu U}, P_{\nu U}])^T [P_{\mu U}, P_{\nu U}]$$





**Venkatesh and Chanthirababu**

Let  $Z = \langle [Z_{\mu L}, Z_{\nu L}], [Z_{\mu U}, Z_{\nu U}] \rangle$

Then,  $[P_{\mu L}, P_{\nu L}] [Z_{\mu L}, Z_{\nu L}]$

$$\begin{aligned} &= [W_{\mu L}, W_{\nu L}] ([P_{\mu L}, P_{\nu L}])^T [P_{\mu L}, P_{\nu L}] \left( ([P_{\mu L}, P_{\nu L}])^T [P_{\mu L}, P_{\nu L}] \right)^{-} ([P_{\mu L}, P_{\nu L}])^T \\ &= [W_{\mu L}, W_{\nu L}] ([P_{\mu L}, P_{\nu L}])^T [P_{\mu L}, P_{\nu L}] \left( ([P_{\mu L}, P_{\nu L}])^T [P_{\mu L}, P_{\nu L}] \right)^{-} ([P_{\mu L}, P_{\nu L}])^T [P_{\mu L}, P_{\nu L}] ([W_{\mu L}, W_{\nu L}])^T \\ &= [W_{\mu L}, W_{\nu L}] \left( ([P_{\mu L}, P_{\nu L}])^T [P_{\mu L}, P_{\nu L}] \right) \left( ([P_{\mu L}, P_{\nu L}])^T [P_{\mu L}, P_{\nu L}] \right)^{-} \left( ([P_{\mu L}, P_{\nu L}])^T [P_{\mu L}, P_{\nu L}] \right) ([W_{\mu L}, W_{\nu L}])^T \\ &= [W_{\mu L}, W_{\nu L}] \left( ([P_{\mu L}, P_{\nu L}])^T [P_{\mu L}, P_{\nu L}] ([W_{\mu L}, W_{\nu L}])^T \right) \\ &= [W_{\mu L}, W_{\nu L}] ([P_{\mu L}, P_{\nu L}])^T \end{aligned}$$

Similarly,

$[P_{\mu U}, P_{\nu U}] [Z_{\mu L}, Z_{\nu L}] = [W_{\mu U}, W_{\nu U}] ([P_{\mu U}, P_{\nu U}])^T$ . Then by equation (3) we have

$PZ = XP^T$

$$\begin{aligned} ([P_{\mu L}, P_{\nu L}] [Z_{\mu L}, Z_{\nu L}])^T &= ([W_{\mu L}, W_{\nu L}] ([P_{\mu L}, P_{\nu L}])^T)^T \\ &= [P_{\mu L}, P_{\nu L}] ([W_{\mu L}, W_{\nu L}])^T \\ &= [W_{\mu L}, W_{\nu L}] ([P_{\mu L}, P_{\nu L}])^T [P_{\mu L}, P_{\nu L}] ([W_{\mu L}, W_{\nu L}])^T \\ &= [W_{\mu L}, W_{\nu L}] ([P_{\mu L}, P_{\nu L}])^T = [P_{\mu L}, P_{\nu L}] [Z_{\mu L}, Z_{\nu L}] \end{aligned}$$

Similarly,

$$([P_{\mu U}, P_{\nu U}] [Z_{\mu U}, Z_{\nu U}])^T = ([W_{\mu U}, W_{\nu U}] ([P_{\mu U}, P_{\nu U}])^T)^T$$

Then, using equation (3),

we get,

$$(PZ)^T = PZ, Z \in P\{3\}.$$

Then  $R(P) = R(P^T P)$

By Theorem (2.4) and Reg of  $P^T P$

we get  $P = P(P^T P)^{-} (P^T P) = PZP, Z \in P\{1\}$ .

Thus P has a {1,3} inverse.

**Theorem:4.3** Let  $P = \langle [P_{\mu L}, P_{\nu L}], [P_{\mu U}, P_{\nu U}] \rangle \in \text{IVIFM}_{mn}$ , P has {1,4} inverse iff  $PP^T$  is a RegIVIFM and  $C(PP^T) = C(P)$ .

Proof: Similar to Theorem (3.6), this can be shown.

**Theorem:4.4** Let  $P = \langle [P_{\mu L}, P_{\nu L}], [P_{\mu U}, P_{\nu U}] \rangle \in \text{IVIFM}_{mn}$ , be a Reg IVIFM with  $P^T P$  is a RegIVIFM,  $R(P^T P) = R(P)$  then

$$Z = (P^T P)^{-} P^T \in P\{1, 2, 3\}.$$

Proof: Let  $Z \in P\{1, 3\}$  follows from Theorem (3.6), it is enough verify

$$Z = \langle [Z_{\mu L}, Z_{\nu L}], [Z_{\mu U}, Z_{\nu U}] \rangle \in P\{2\}$$





**Venkatesh and Chanthirababu**

that is  $[Z_{\mu L}, Z_{\nu L}][P_{\mu L}, P_{\nu L}][Z_{\mu L}, Z_{\nu L}] = [Z_{\mu L}, Z_{\nu L}]$  and

$$\begin{aligned}
 & [Z_{\mu U}, Z_{\nu U}][P_{\mu U}, P_{\nu U}][Z_{\mu U}, Z_{\nu U}] = [Z_{\mu U}, Z_{\nu U}] \\
 & [Z_{\mu L}, Z_{\nu L}][P_{\mu L}, P_{\nu L}][Z_{\mu L}, Z_{\nu L}] \\
 & = [Z_{\mu L}, Z_{\nu L}] \left( ([X_{\mu L}, X_{\nu L}])^T \left( ([P_{\mu L}, P_{\nu L}])^T [P_{\mu L}, P_{\nu L}] \right) \right) \left( ([P_{\mu L}, P_{\nu L}])^T [P_{\mu L}, P_{\nu L}] \right)^{-} ([P_{\mu L}, P_{\nu L}])^T \\
 & = [Z_{\mu L}, Z_{\nu L}] \left( ([X_{\mu L}, X_{\nu L}])^T \left( ([P_{\mu L}, P_{\nu L}])^T [P_{\mu L}, P_{\nu L}] \right) \right) \left( ([P_{\mu L}, P_{\nu L}])^T [P_{\mu L}, P_{\nu L}] \right)^{-} \left( ([P_{\mu L}, P_{\nu L}])^T [P_{\mu L}, P_{\nu L}][X_{\mu L}, X_{\nu L}] \right) \\
 & = [Z_{\mu L}, Z_{\nu L}] ([X_{\mu L}, X_{\nu L}])^T ([P_{\mu L}, P_{\nu L}])^T [P_{\mu L}, P_{\nu L}] ([X_{\mu L}, X_{\nu L}]) \\
 & = [Z_{\mu L}, Z_{\nu L}][P_{\mu L}, P_{\nu L}][X_{\mu L}, X_{\nu L}] \\
 & = \left[ \left( ([P_{\mu L}, P_{\nu L}])^T [P_{\mu L}, P_{\nu L}] \right)^{-} ([P_{\mu L}, P_{\nu L}])^T \right]^T [P_{\mu L}, P_{\nu L}][X_{\mu L}, X_{\nu L}] \\
 & = \left( ([P_{\mu L}, P_{\nu L}])^T [P_{\mu L}, P_{\nu L}] \right)^{-} \left( ([P_{\mu L}, P_{\nu L}])^T [P_{\mu L}, P_{\nu L}][X_{\mu L}, X_{\nu L}] \right) \\
 & = \left( ([P_{\mu L}, P_{\nu L}])^T [P_{\mu L}, P_{\nu L}] \right)^{-} ([P_{\mu L}, P_{\nu L}])^T \\
 & = [Z_{\mu L}, Z_{\nu L}]
 \end{aligned}$$

Similarly,  $[Z_{\mu U}, Z_{\nu U}][P_{\mu U}, P_{\nu U}][Z_{\mu U}, Z_{\nu U}] = [Z_{\mu U}, Z_{\nu U}]$

Then by equation (3),  $ZPZ=Z$

Thus  $Z = (P^T P)^{-} P^T \in P\{1, 2, 3\}$ .

**Theorem 4.5** Let  $P = \langle [P_{\mu L}, P_{\nu L}], [P_{\mu U}, P_{\nu U}] \rangle \in \text{IVIFM}_{mn}$ , be a Reg IVIFM with  $PP^T$  is a Reg IVIFM,  $R(P^T) = R(PP^T)$

then  $Z = P^T (P P^T)^{-} \in P\{1, 2, 4\}$ .

Proof: The proof was omitted because it is related to that of theorem (4.4).

**REFERENCES**

1. Kim, K.H., and Roush, F.N., (1980), Generalized fuzzy matrices, Fuzzy sets and systems, 4, 293 – 315.
2. Meenakshi, AR., and Kaliraja, M., (2010), Regular Interval Valued Fuzzy Matrices, Advances in Fuzzy Mathematics, Vol 5, No 1, 7 -15.
3. Meenakshi, AR., and Jenita, P., (2011), Generalized Regular Fuzzy Matrices, Iranian Journal of Fuzzy Systems, Vol 8, No 2, 133 – 141.
4. Shyamal, A.K., and Pal, M., (2006), Interval Valued Fuzzy Matrices, Journal of Fuzzy Mathematics, Vol 14, No 3, 582 – 592.
5. Thomason, M.G., (1977), Convergence of powers of fuzzy matrix, J.Math Anal. Appl. 57, 476 – 480.
6. Meenakshi, AR., Fuzzy Matrix Theory and Applications, MJP. Publishers, Chennai, 2008.
7. Shyamal, A.K. & Pal, M., Interval Valued Fuzzy Matrices, Journal of Fuzzy Mathematics, 14(3), pp. 582-592, 2006.
8. Meenakshi, AR. & Kaliraja, M., Regular Interval Valued Fuzzy Matrices, Advances in Fuzzy mathematics, 5(1), pp. 7-15, 2010.
9. Ben Israel, A. & Greville, T.N.E, Generalized Inverses, Theory and Application, John Wiley, New York, 1976.
10. Meenakshi, AR. & Kaliraja, M., g-Inverses of Interval Valued Fuzzy Matrices, J. Math. Fund. Sci., Vol. 45, No. 1, 2013, 83-92.





## Formulation Development and Evaluation of Floating Beads by Iontropic Gelation Method of Esomeprazole Magnesium Trihydrate

Rohini Reddy<sup>1\*</sup>, Supriya Dumpaty<sup>2</sup> and Srinivas Nimmagada<sup>3</sup>

<sup>1</sup>Associate Professor, Department of Pharmacy, Sarojini Naidu Vanita Pharmacy Mahavidyalaya, Osmania University, Hyderabad, Telangana, India.

<sup>2</sup>Student, Department of Pharmacy, Sarojini Naidu Vanita Pharmacy Mahavidyalaya, Osmania University, Hyderabad, Telangana, India.

<sup>3</sup>Professor, Department of Pharmacy, Sarojini Naidu Vanita Pharmacy Mahavidyalaya, Osmania University, Hyderabad, Telangana, India.

Received: 22 Jan 2024

Revised: 09 Feb 2024

Accepted: 09 May 2024

### \*Address for Correspondence

#### Rohini Reddy

Associate Professor,  
Department of Pharmacy,  
Sarojini Naidu Vanita Pharmacy Mahavidyalaya,  
Osmania University,  
Hyderabad, Telangana, India.  
Email: rohinishimmula@gmail.com



This is an Open Access Journal / article distributed under the terms of the **Creative Commons Attribution License** (CC BY-NC-ND 3.0) which permits unrestricted use, distribution, and reproduction in any medium, provided the original work is properly cited. All rights reserved.

### ABSTRACT

The objective of this present investigation is to develop floating beads of anti-ulcer sustained release alginate beads of esomeprazole magnesium trihydrate by the ionotropic gelation method as an approach to increase gastric residence time. The floating beads were prepared by dispersing sodium alginate in water to this Carbopol 940p or HPMC were added, then Esomeprazole magnesium trihydrate was added with CaCO<sub>3</sub> (as gas generating agent) to a solution of sodium alginate. The resulting solution was then extruded through a 22gauge syringe needle into 100 ml cross-linking solution containing calcium chloride (1% w/v). The prepared beads were evaluated for their encapsulation efficiency, floating lag time, particle size, FTIR spectroscopy, scanning electron microscopy (SEM) and release behaviour. In-vitro drug release profile of the micro beads was evaluated using rotating paddle USP dissolution apparatus type II. The dissolution study revealed that, after ten hours the percentage of drug release for formulation F8 96.82%. The release of drug from the prepared formulations follows first order and korsmeyer-peppas model.

**Keywords:** Floating beads, esomeprazole magnesium trihydrate, scanning electron microscopy (SEM), FTIR and in-vitro dissolution studies.



Rohini Reddy *et al.*,

## INTRODUCTION

The present study was to develop and evaluate floating beads of Esomeprazole Magnesium Trihydrate. Floating beads of Esomeprazole was prepared by ionotropic Gelation method [1] using sodium alginate. Eight different formulations were developed. The developed floating beads were evaluated for percentage yield, particle size, Floating lag time, Floating duration time, scanning electron microscopy [2] and drug release. The polymers used are HPMC & Carbopol. FTIR study results showed that there were no incompatibility between drug and polymer. Solubility study was performed and recorded the results. Results of our present study suggest that floating beads of Esomeprazole Magnesium can be successfully designed for controlled drug delivery which can reduce dosing frequency making the formulation an effective alternative to conventional dosage forms [3].

## MATERIALS AND METHODS

Esomeprazole Magnesium trihydrate, active pharmaceutical ingredient was procured from local vendor. Carbopol 940 P (Loba Chemie Pvt. Ltd., Mumbai, India), HPMC (Qualigens Fine Chemicals, Mumbai, India), were procured and used in this investigation. The entire chemicals of analytical grade and double distilled water used throughout the experiment.

### Development of standard calibration Curve

Preparation of standard stock solution of drug

Esomeprazole magnesium trihydrate should be carefully weighed and dissolved in 100 ml of ethanol. This results in a standard stock solution concentration of 1000 µg/ml [5].

### Preparation of working stock solution

10 ml of the drug's standard stock solution was taken, and it was then diluted with 0.1N HCl to a final concentration of 100 ml. This results in a working standard stock solution with a concentration of 100 µg/ml [6].

### Preparation of working dilutions

1, 1.5, 2, 2.5, 3, 3.5, 4, 4.5, and 5 ml were taken from the working standard stock solution and volume was made up to 10 ml with 0.1N HCl to produce 10, 15, 20, 25, 30, 35, 40, 45, and 50 µg/ml concentrations, respectively.

### Standard calibration curve

Drug solution concentrations of 10, 15, 20, 25, 30, 35, 40, 45, and 50 µg/ml were scanned using a UV spectrophotometer at 302 nm against 0.1N HCl as the reference solution. With absorbance on the Y-axis and concentration (µg/ml) on the X-axis, a graph was created. This graph provides a calibrated standard graph for drug solutions. Using a UV spectrophotometer, these working dilutions were scanned at 301 nm to determine their absorbance [7].

### Formulation of esomeprazole magnesium trihydrate floating beads

#### Formulation design

Esomeprazole magnesium trihydrate floating beads were created using the ionotropic gelation method, cross linking agents sodium alginate and calcium chloride, calcium carbonate as a gas forming agent, HPMC is a polymer and Carbopol 940 P as a crosslinking poly acrylic acid. Various formulation trials were created using various polymer concentrations. They receive formulation codes assigned to them [8].

## PROCEDURE

Esomeprazole magnesium trihydrate floating beads was prepared using ionotropic gelation method as per the formulation as shown in table 1. Weigh required amount of sodium alginate add 100 ml of distilled water and from







Rohini Reddy *et al.*,

formulations F1-F4, weigh required amount of HPMC and from F5-F8 take Carbapol 940 P and place it on the magnetic stirrer with 100 rpm after complete mixing of the solution, add required amount of calcium carbonate and drug to the above solution. Place this solution in sonicator at least for 1hr till the air bubbles get evaporated this is solution A. In another beaker weigh required amount of calcium chloride and dissolve it in distilled water. Place the solution A on the magnetic stirrer take solution B in 22-gauge syringe needle inject it drop by drop. Using what's man filter paper and dry it for 24 h at room temperature [9-10].

## RESULTS AND DISCUSSION

### Preformulation studies

#### Solubility

Solubility is the important parameter for formulation studies because, It has an impact on how the drug dissolves. Both oral administration and drug dissolution have a direct impact on a drug's bioavailability. Particle size, shape, and surface area should be determined during formulation because they may affect the way a drug dissolves [11].

#### Method

The solubility of the drug was assessed after a weighed quantity was added to the appropriate volume of solvent.

#### Melting point

The temperature at which a substance transforms from a solid to a liquid state is known as its melting point. Pure crystals have a distinct, well-defined melting point. The most common method for determining melting points is the capillary method. In this method, a high accuracy thermometer is placed close to a heated stand (a metal block or liquid bath) that contains a thin glass capillary tube containing a compact column of the drug to be determined. Until the drug in the tube transitions into the liquid state, the temperature in the heating stand is ramped up at a user-programmable fixed rate [12].

### Analytical Methodology

#### Determination of absorption maximum of Esomeprazole magnesium trihydrate

Determination of absorption maximum of Esomeprazole magnesium trihydrate using 10 µg/ml by using UV spectrophotometer against 0.1N HCl. Esomeprazole Magnesium trihydrate shows good linearity with the range 10 to 50 µg/ml in 0.1N HCl. with  $R^2=0.999$ , Slope = 0.087. The regression value was closer to 1 indicating the method obeyed Beer-Lambert's law.

### Compatibility studies

#### Drug excipient compatibility study

#### Evaluation of esomeprazole magnesium trihydrate floating beads

#### Micromeritic properties of different formulation of esomeprazole magnesium trihydrate

#### Floating studies

#### Drug Entrapment Efficiency

#### Particle size analysis

### In-vitro Dissolution studies of Esomeprazole magnesium trihydrate floating beads

- In vitro % drug release studies was done by using 0.1 N HCl for formulations F1- F8 of esomeprazole magnesium trihydrate floating beads by using sodium alginate, Carbopol 940 P, calcium carbonate and calcium chloride for 10 h.
- Percentage drug release for F1 which contain 1% sodium alginate and 5% HPMC was 82.84% for 10 h.
- Percentage drug release for F2 which contain 1% sodium alginate and 10% HPMC was 83.47% for 10 h.
- Percentage drug release for F3 which contain 2% sodium alginate and 15% HPMC was 84.56% for 10hrs.
- Percentage drug release for F4 which contain 2% sodium alginate and 20% HPMC was 85.18% for 10 h.



**Rohini Reddy et al.,**

- So further trials were made by using Carbopol 940 P.
- Percentage drug release for F5 which contain 1% sodium alginate and 5% Carbopol 940 P was 86.6% for 10 h. Percentage drug release for F6 which contain 1% sodium alginate and 10% Carbopol 940 P was 87.68% for 10 h. Percentage drug release for F7 which contain 2% sodium alginate and 15% Carbopol 940 P was 89.34% for 10hrs. Percentage drug release for F8 which contain 2% sodium alginate and 20% Carbopol 940 P was 96.82% for 10 h.
- By observing all the 8 formulations it has been shown that the F8 formulation is considered as optimizes formulation containing sodium alginate and Carbopol 940 P showed maximum drug release for desired period of time (10 h).
- So F8 formulation is chosen for release kinetics and evaluated.

**Model dependent kinetics for the optimised formulation****DISCUSSION**

The results of R2 value for first order and korsmeyer peppas model were obtained as 0.95 which are close to '1' based on that we confirm the optimised formulation F8 follows first order kinetics. Scanning electron microscopy was used to know surface morphology of microspheres. The SEM photographs of F 8 revealed that microspheres were spherical, discrete with 50µm range.

**CONCLUSION**

Esomeprazole Magnesium Trihydrate floating beads can be created as a way to lengthen the duration the drug stays in the stomach. With the goal of producing floating beads of esomeprazole magnesium trihydrate, floating beads of the medication were created using the ionotropic gelation procedure. In the current work, a total of eight formulations employing F1 to F4 were prepared by HPMC, while F5 to F8 were prepared using Carbopol 940P. Scanning electron microscopy was used to study the beads morphology. In comparison to HPMC, Carbopol 940 P exhibits good drug release and a maximum floating time. The optimised formulations provided the optimum fit for the medication release pattern. to the first order kinetics and Korsmeyer-Peppas model. In conclusion, extremely encouraging in vitro drug release findings were found with formulation F8.

**REFERENCES**

1. Chien Y. W., "Novel Drug Delivery system", (2nd ed.), Marcel Dekker. 1992; 139-196.
2. Caldwell LJ, Gardner RC, Cargill RC. Drug delivery device which can be retained in the stomach for a controlled period of times, US patent 4735804, April 5, 1988.245-262.
3. Chen J, park k, Synthesis and characterization of superporous hydrogel composites., J.Contro. Release. 2000; 65 (1-2):73-82.
4. C.V.S Subramanyam "Text Book Physical Pharmaceutics" 2nd Edition, Delhi, Vallabh Prakashan,2000, pp: 222-224.
5. Choi BY, Park HJ, Hwang SJ, Park JB. Preparation of alginate beads for floating drug delivery system: Effect of CO<sub>2</sub> gas-forming agents. Int J Pharm 2002;239:81-91.
6. Chowdary, k.p.r and Srinivasava Rao Y "Preparation and Evaluation of Mucoadhesive Microspheres Of Indomethacin" Ind.j.Pharm.Sci.2003 49-52.
7. Davis SS. "Formulation strategies for absorption, windows", Drug Discovery Today. 2005; 10:249-256.
8. Dusel R. et al Sodium alginate in "Handbook of pharmaceutical excipients", published by American pharmaceutical association and the pharmaceutical society of great Britain, 1986 : 257-258.
9. Deepaa MK, Karthikeyanb M. Cefpodoxi me proxetil floating microspheres: Formulation and in vitro evaluation. Iran J Pharm Sci 2009;5:69-72.



Rohini Reddy *et al.*,

10. Dave BS, Amin AF, Patel MM. Gastro-retentive drug delivery system of ranitidine hydrochloride: Formulation and in vitro evaluation. AAPS PharmSciTech 2004;5:e34.
11. El-kamal AH, Sokar MS, Al Gamal SS, Naggar VF. Preparation and evaluation of ketoprofen floating oral delivery systems. Int J Pharm 2001;220:13-21.
12. El-Gibaly I. Development and in vitro evaluation of novel floating chitosan microcapsules for oral use: Comparison with non-floating chitosan microspheres. Int J Pharm 2002;249:

**Table 1: Formulation trials (composition) of esomeprazole magnesium trihydrate floating beads**

Ingredients	F1	F2	F3	F4	F5	F6	F7	F8
Esomeprazole magnesium trihydrate(mg)	20	20	20	20	20	20	20	20
Sodium alginate(%w/v)	1	1	2	2	1	1	2	2
HPMC (mg)	5	10	15	20	-	-	-	-
Carbopol 940P(mg)	-	-	-	-	5	10	15	20
Calcium carbonate(mg)	5	10	15	20	25	30	35	40
Calcium chloride(%w/v)	5	5	5	5	5	5	5	5

**Table 2: Solubility profile of esomeprazole magnesium trihydrate**

S. No.	Solvent	Observed
1	0.1N HCl	Freely soluble
2	Ethanol	Freely soluble
3	Dichloro Methane	Freely soluble

**Table 3: Melting point of Esomeprazole magnesium trihydrate**

Trial	Melting point observed	Average melting point	Reference melting point
1.	181		
2.	184	184	182-191°C
3.	188		

**Table 4: Interpretation of Drug & Excipients**

S.No	Functional group	IR absorbance(cm <sup>-1</sup> )Theoretical	IR absorbance(cm <sup>-1</sup> )observed
1	S=O	980-1225	1077.80
2	C-N	1250-1335	1271.28
3	C-H	675-900	808.51

**Table 5: Flow properties of different formulation of esomeprazole magnesium trihydrate**

Formulation code	Angle of repose (θ)	Bulk density (gm/cm <sup>3</sup> )	Tapped density (gm/cm <sup>3</sup> )	Carr's index (I)%
F1	25.47±0.21	0.510±0.36	0.529±0.28	14.46±0.25
F2	26.78±0.34	0.320±0.31	0.370±0.36	13.50±0.34
F3	25.57±0.25	0.565±0.21	0.681±0.21	12.75±0.27
F4	25.68±0.36	0.310±0.25	0.350±0.25	11.41±0.38
F5	26.58±0.36	0.526±0.39	0.598±0.34	11.36±0.27
F6	25.68±0.36	0.310±0.16	0.350±0.35	11.41±0.38
F7	26.78±0.34	0.320±0.34	0.370±0.38	13.50±0.36
F8	24.47±0.25	0.560±0.36	0.641±0.25	12.55±0.31



Rohini Reddy *et al.*,**Table 6: Floating lag time studies of all formulation F1-F8 of esomeprazole magnesium trihydrate floating beads**

Formulationcode	Floatinglag time	Total floating time
F1	5min	Not Floated
F2	10min	Not Floated
F3	10min	Not Floated
F4	20min	5hrs
F5	10min	6hrs
F6	7min	8hrs
F7	7min	>12hrs
F8	2min	>12hrs

**Table 7: Drug entrapment efficiency of all formulation F1-F8 of Esomeprazole magnesium trihydrate floating beads**

Formulation	Drug
F1	79.66
F2	81.38
F3	88.97
F4	83.42
F5	85.39
F6	90.28
F7	91.59
F8	98.24

**Table 8: Particle size analysis of all formulation F1-F8 of Esomeprazole magnesium trihydrate floating beads**

Formulation	Particle size(microns)
F1	40-60
F2	20-80
F3	50-70
F4	30-40
F5	30-80
F6	50-60
F7	60-80
F8	70-90

**Table 9: In-vitro Dissolution studies of all formulation F1-F8 of esomeprazole magnesium trihydrate floating beads**

Time	F1	F2	F3	F4	F5	F6	F7	F8
0	0	0	0	0	0	0	0	0
1	7.56 ± 0.22	7.21 ± 0.32	7.25 ± 0.12	9.931 ± 0.23	8.68 ± 0.28	8.55 ± 0.32	8.6 ± 0.28	11.17 ± 0.22
2	10.54 ± 0.23	11.43 ± 0.52	12.54 ± 0.22	14.89 ± 0.43	11.17 ± 0.31	13.8 ± 0.39	14.9 ± 0.31	16.13 ± 0.29
3	20.54 ± 0.42	22.89 ± 0.65	20.54 ± 0.31	22.34 ± 0.65	16.13 ± 0.45	20.34 ± 0.41	23.5 ± 0.32	26.06 ± 0.38
4	26.65 ± 0.46	28.89 ± 0.69	27.56 ± 0.49	27.31 ± 0.59	18.62 ± 0.48	26.31 ± 0.49	28.55 ± 0.42	31.03 ± 0.41
5	30.87 ± 0.51	31.54 ± 0.71	29.52 ± 0.55	31.03 ± 0.75	26.03 ± 0.51	32.19 ± 0.54	34.48 ± 0.45	38.48 ± 0.55





6	37.25 ± 0.62	38.46 ± 0.79	35.24 ± 0.59	36.01 ± 0.79	34.75 ± 0.59	35.58 ± 0.58	40.17 ± 0.48	42.2 ± 0.56
7	44.57 ± 0.71	45.21 ± 0.81	42.58 ± 0.65	43.44 ± 0.89	42.21 ± 0.61	45.32 ± 0.60	47.17 ± 0.52	50.88 ± 0.58
8	57.23 ± 0.79	58.21 ± 0.85	54.87 ± 0.69	55.75 ± 0.86	54.64 ± 0.65	59.09 ± 0.62	53.24 ± 0.53	65.28 ± 0.59
9	70.65 ± 0.81	71.46 ± 0.89	66.58 ± 0.71	70.13 ± 0.90	67.03 ± 0.71	68.8 ± 0.69	72.2 ± 0.62	76.96 ± 0.61
10	82.84 ± 0.85	83.47 ± 0.90	84.56 ± 0.75	85.18 ± 0.92	86.06 ± 0.82	87.68 ± 0.79	89.34 ± 0.72	96.82 ± 0.72

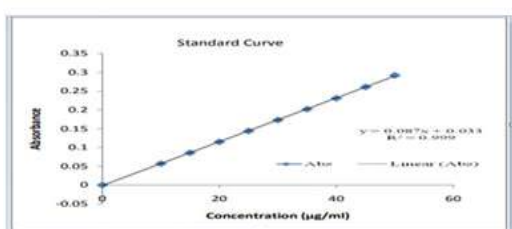


Figure 1: Standard Graph of Esomeprazole magnesium trihydrate in 0.1N HCl

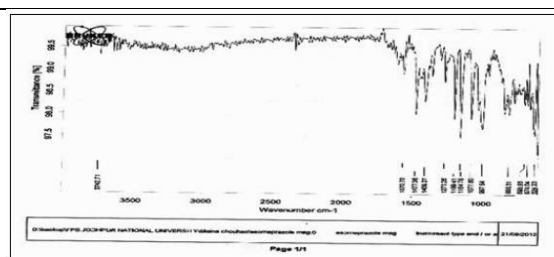


Figure 2: FTIR spectra of pure drug esomeprazole magnesium trihydrate

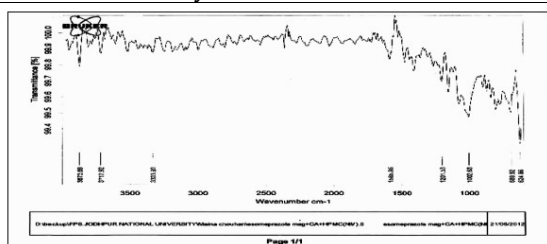


Figure 3: FTIR spectra of pure drug esomeprazole magnesium trihydrate + Carbopol 940 P

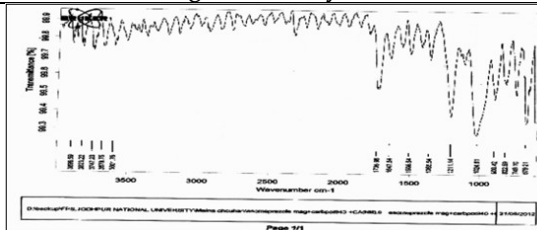


Figure 4: FTIR spectra of pure drug esomeprazole magnesium trihydrate + HPMC

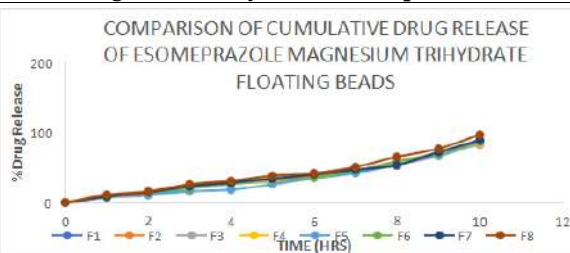


Figure 5: In-vitro % Drug release of all formulation F1-F8 of Esomeprazole magnesium trihydrate floating beads

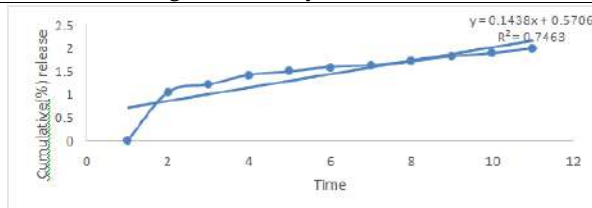


Figure 6: Zero order kinetics





Rohini Reddy et al.,

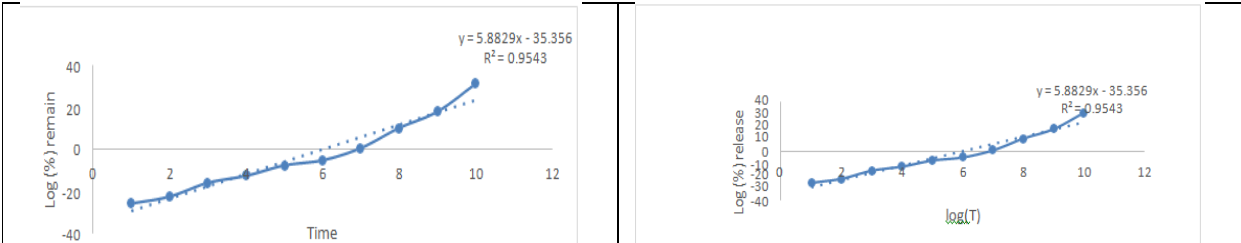


Figure 7: First order kinetics

Figure 8: Korsmeyer-peppas model

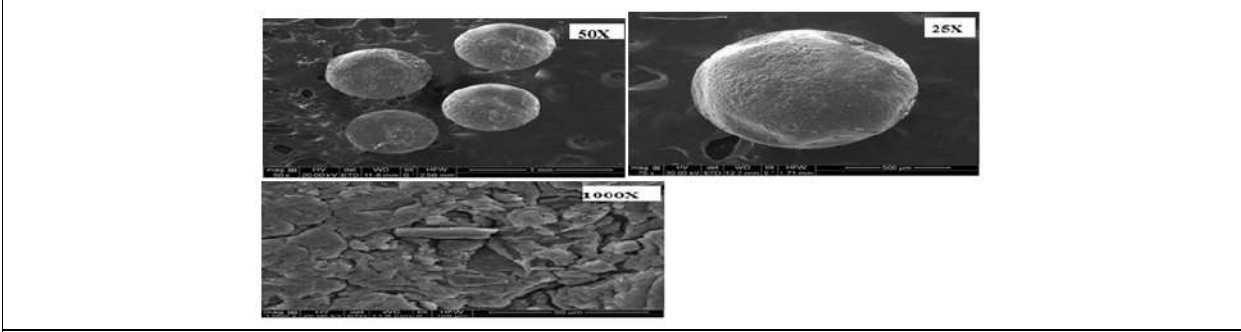


Figure 9: SEM analysis of optimized formulation F8





## Common Psychological Stressors in Parents of Preterm Babies: A Cross - Sectional Study

Shweta Desai<sup>1\*</sup>, R. Harihara Prakash<sup>2</sup>, Jigar N. Mehta<sup>3</sup> and Ankur Mahida<sup>4</sup>

<sup>1</sup>Assistant Professor, College of Physiotherapy, Sumandeep Vidyapeeth deemed to be University, Vadodara, Gujarat, India.

<sup>2</sup>Professor and Principal, K.M. Patel Institute of Physiotherapy, Bhaikaka University, Karamsad, Gujarat, India.

<sup>3</sup>Associate Professor, K.M. Patel Institute of Physiotherapy, Bhaikaka University, Karamsad, Gujarat, India.

<sup>4</sup>Assistant Professor, Department of Psychology, Lokbharati University for Rural Innovation, Sanosara, Bhavnagar, Gujarat, India.

Received: 22 Jan 2024

Revised: 09 Feb 2024

Accepted: 10 May 2024

### \*Address for Correspondence

**Shweta Desai**

Assistant Professor,

College of Physiotherapy,

Sumandeep Vidyapeeth deemed to be University,

Vadodara, Gujarat, India.

Email: dsweta067@gmail.com



This is an Open Access Journal / article distributed under the terms of the **Creative Commons Attribution License** (CC BY-NC-ND 3.0) which permits unrestricted use, distribution, and reproduction in any medium, provided the original work is properly cited. All rights reserved.

### ABSTRACT

Preterm birth is described as any birth that occurs before 37 weeks of gestation. Giving birth to a high-risk newborn requires hospitalization in the Neonatal Intensive Care Unit (NICU). Multiple factors may contribute to severe psychological stress among parents of preterm children in the NICU. This study **aims** to identify common stressors in both parents of preterm children in the NICU. In the 2020-2022 academic year, a cross-sectional study enrolled 60 parents of first or subsequent preterm infants (single or twins) at less than 37 weeks gestational age from Karamsad, India, within the first 10 days of their NICU hospitalization after a child's birth. To identify frequent stressors in parents the modified Kuppaswamy scale and Performa with demographic information were employed. Independent pair t-test, ANOVA test & Tukey test were used in this study for analysis. We evaluated the stress levels of mothers and fathers in the NICU, and the study found that mothers' stress levels were higher than fathers' ( $p=0.0006$ ). Among several characteristics, Upper socioeconomic position ( $p=0.02$ ), a higher education level ( $p=0.04$ ), and more than 6 days of hospitalisation ( $p=0.03$ ) were all associated with a substantial increase in stress in mothers, but not in fathers. Mothers' stress levels in the NICU are significantly higher when they have a higher socioeconomic status, a higher education level, or a stay of more than 6 days, but significant stress is not found in fathers.



**Shweta Desai et al.,****Keywords:** Preterm infants, Parents, Psychological Stressors

## INTRODUCTION

According to the World Health Organisation (WHO), the average pregnancy lasts 40 weeks; nevertheless, preterm delivery is defined as any birth that occurs before 37 weeks of gestation [1]. Every year, around 15 million babies are born prematurely around the world, resulting in an 11% global preterm birth rate.<sup>2</sup> Preterm birth is the biggest cause of mortality among children, accounting for 35% of fatalities among newborns (aged 28 days) & 18% of deaths among children under the age of 5 years [2]. In the United States, between 10% and 15% of all newborns require a Neonatal Intensive Care Unit (NICU) [3]. The NICU should be well-organized to reduce neonatal mortality and morbidity while also enhancing the survival rate of newborns [4]. Giving birth to a sick or high-risk newborn who requires hospitalization in the NICU adds layers of obligation to a mother's already stressful existence [5]. Parents of premature newborns in the NICU have been found to have high levels of psychological distress, including acute anxiety disorder, post-traumatic stress disorder, and depression, according to research [6]. Furthermore, the length of hospitalization has an impact on stress and the length of time that infants spend in the NICU is determined by the severity of their illnesses [3]. Family-centered developmental care (FCDC) provides a solid supportive foundation that families in the NICU require to optimize the lifelong relationship between themselves and their kids, and it acknowledges the family as important members of the NICU healthcare team.<sup>7</sup> but multiple stressors hamper the role of parents in NICU. We require parents to be in good mental health to strengthen their role in the NICU as well as at home following discharge. Therefore this study aims to identify common stressors in both parents of preterm children in the NICU. It will be helpful for the stress management of the parents.

## METHODOLOGY

Before commencing the Observational Cross-Sectional study, the study proposal was prepared and submitted to the "Institutional Ethics Committee (IEC)" for its approval, and permission was obtained to begin the study. Data was collected over two years of duration from a tertiary hospital, Karamsad. A purposive sampling method was used to collect the data. 60 parents of first or subsequent preterm infants (single or twins) at less than 37 weeks gestational age, within the first 10 days of their NICU hospitalization after a child's birth. To identify common stressors in parents the Modified Kuppaswamy Scale and Performa with demographic information were employed. The study enrolled eligible parents who gave written consent then after therapists filled out Performa with demographic information such as the child's gestational age, child sex, birth weight, single or twin preterm infant, post-delivery day, information about the mother and father, prenatal, perinatal, and post-natal history, previous history of death or abortion.

## OUTCOME MEASURES

To determine socioeconomic status, the Modified Kuppaswamy Scale was used. The occupation, education, and monthly income of the family are the three subcomponents of this scale. Modified Kuppaswamy SES has a total score of 3-29 & divides families into five categories: upper class, upper middle class, lower middle class, upper lower, and lower socioeconomic class, with scores of 26-29, 16-25, 11-15, 5-10, & 5 respectively [8]. For statistical purposes we modified the category, in socioeconomic status, we built two categories upper middle and lower middle merged to form the upper category, and upper lower and lower merged to form the lower category. In level of education, we build 3 categories graduate, diploma and high school merged to form higher education level, middle school and primary school merged to form middle education level and 3rd category is illiterate level of education. In type of occupation, we built 2 categories the working group and housewife group for mothers and we built 2 categories that is others group and the elementary group.





**Shweta Desai et al.,****STATISTICAL ANALYSIS**

Statistical analysis of the study was done by using Stata 14.2 software. The data was entered into the computer using a Microsoft Excel sheet, tabulated, and subjected to statistical analysis. Descriptive analysis was used for the characteristics of parents and to calculate the frequency and distribution of parents. The independent pair t-test was used to compare stress levels in mothers and fathers, as well as stress levels linked to demographic characteristics like sex of the child, single / twin preterm child, previous history of death or abortion, and socioeconomic status. The ANOVA test was used to compare stress levels between more than three groups, such as the day of sample collection, education level, and type of occupation. The Tukey test was utilized to complete an in-depth analysis of stress levels on the day of sample collection and in the level of education. Probability values less than 0.05 were considered statistically significant. ( $p < 0.05$ )

**RESULT**

A total of 60 parents who gave birth to preterm children were analysed. Table 1 represents the distribution of all parents at baseline in terms of the child's birth weight (in grams), mothers' age, fathers' age, and gestational weeks. The mean (SD) values were 1935.15 482.94, 26.43 5.05, 28.4 5.26, and 34.67 2.00, respectively. Table 2 represents the several characteristics that cause stress in mothers, which include socioeconomic status, child sex, level of education, type of profession, single or twin preterm infant, previous history of death or abortion, and day of sample collection. Except for socioeconomic status, education level, and the day of sample collection, none of these factors had a significant impact on the mother's stress level. Table 3 represents how a mother's educational level affects her stress level in further detail. In this study, we compare how higher, middle, and illiterate education levels affect mothers' stress levels. When comparing higher education levels to middle and illiterate education levels, higher education levels cause more stress in mothers, however, there was no significant difference in stress levels between middle and illiterate education levels. Table 4 represents the day of sample collection that affects mothers' stress levels in further detail. In this study, we compare which day in the NICU the mother's stress level is the highest. When comparing  $\geq 6$  days to  $= 2$  days and 3-5 days, it was found that  $\geq 6$  days induce more stress in mothers, but there was no significant difference in stress levels between  $= 2$  days and 3-5 days. Table 5 represents the several characteristics that cause stress in fathers, which include socioeconomic status, child sex, level of education, type of profession, single or twin preterm infant, previous history of death or abortion, and day of sample collection. In this study, there was no significant difference in the stress levels of fathers in any of the components. Table 6 shows the comparison between the stress levels of mothers and fathers. So, in this study, the pre-and post-scores both indicate that the mothers are more stressed than the fathers.

**DISCUSSION****VARIABLES IN OUR STUDY**

In this study, we compared certain variables that affect the level of stress in the NICU, such as socioeconomic status, the child's sex, level of education, type of occupation, any previous history of death or abortion, and the day the sample was taken. All of these things might cause stress in both parents.

**PARENTS' STRESS AND SOCIOECONOMIC STATUS**

The level of stress in upper and lower socioeconomic classes was compared in this study for both parents. To determine socioeconomic status, the Modified Kuppuswamy scale was used. Socioeconomic status (SES) is determined not only by income but also by educational and occupational achievement. As a result, a higher level of education and high-status work alter the SES.<sup>9,10</sup> In our study, we discovered that higher socioeconomic status causes greater stress in mothers as compared to lower socioeconomic status. However, there was no significant difference in stress levels between upper and lower socioeconomic status for fathers. [Refer Table: 2,5] As a result of higher education and high-status occupations, found in the upper SES community, they might have a greater understanding of the children's situation than the lower SES population. However, other studies have revealed that parents with a lower socioeconomic status experience more stress [11, 12,13,14,15].





Shweta Desai et al.,

#### PARENTS' STRESS AND SEX OF THE CHILD

The stress levels for male and female preterm children were compared in this study for both parents. There was no significant variation found in stress levels based on the child's gender. [Refer Table: 2,5] Parental stress is unrelated to the gender of the child, according to Genget al [16].

#### PARENTS' STRESS AND LEVEL OF EDUCATION

For both parents, we compare stress levels in higher, middle, or illiterate levels of education. We found that mothers with a higher level of education experience significant stress than mothers with a lower level of education. However, for fathers with a higher, moderate, or illiterate level of education, there was no significant difference in stress levels. [Refer Table: 2,3,5] Possible explanations include a better understanding of the children's situation, a stronger belief that NICU admission is necessary for their child, and a clearer understanding of the importance of usage of equipment and technology in their infants' condition. According to Dudeks' study "Parent stress in the neonatal intensive care unit and the influence of parent and infant characteristics" explain that there correlates with the level of education and stress level in parents with preterm children [17].

#### PARENTS' STRESS AND TYPE OF OCCUPATION

In this study, the stress levels of both parents were compared with various occupations such as working and housewife for mothers and elementary occupation and others for fathers. In both parents, there was no significant difference in stress levels based on their occupation. [Refer Table: 2,5] In a study titled "Parenting stress and coping techniques adopted among working and non-working mothers and their association with socio-demographic variables: A cross-sectional study," RidhiRajgariah et al discovered that there was no correlation between type of occupation and parental stress level [18].

#### PARENTS' STRESS AND SINGLE/TWINS PRETERM CHILD

This study evaluated the stress levels of both parents for single and twin preterm children. There was no definite correlation between parental stress and the number of children. [Refer Table: 2,5] According to Glazebrook et al study "Parenting stress among first-time mothers of twins and triplets conceived after in vitro fertilization" found that stress levels were similar regardless of the number of children [19].

#### PARENTS' STRESS AND PREVIOUS H/O DEATH OR ABORTION

In this study, we compared parental stress related to previous h/o abortion or death in both parents. We found no significant differences in previous h/o abortion or death groups and no previous h/o abortion or death groups. [Refer Table: 2,5] M Antonia Biggs et al conducted the study "Does abortion increase women's risk for post-traumatic stress? Findings from a prospective longitudinal cohort study" concluded that abortion is not a source of stress for parents [20].

#### PARENTS' STRESS ASSOCIATED WITH LIVE CHILD AT HOME

Furthermore, we discovered in our research that having another living child at home causes more stress in parents, particularly in mothers, than having a premature child admitted to the NICU. In our study of 60 parents, 10 parents stated that they were more concerned about their other children who were left alone at home and had to be separated from them because they had to be in hospitals for an extended period.

#### PARENTS' STRESS AND DAY OF SAMPLE COLLECTION (LENGTH OF STAY)

We correlated stress levels in both parents with the length of stay to see which day had the most stress (=2 days, 3-5 days, or >=6 days). During >=6 days, we noticed that the mother's stress level was significantly greater. However, there was no correlation between the length of stay and parental stress among fathers. [Refer Table: 2,4,5] The reason for this result could be a common stressor that causes increased stress in parents, such as disruption of the normal routine, fear of losing the child, infants' appearance and behavior, sight and sound, staff behavior and communication, and parental role changes etc, all of which can lead to negative feelings like anxiety, depression, anger, helplessness, and confusion and as the length of stay in the hospital increases, parents are exposed to these





Shweta Desai et al.,

stressors for extended periods, producing additional stress. The study " Stress and Feelings in Mothers and Fathers in NICU: Identifying Risk Factors for Early Interventions" by Chiara Ionio et al found stress levels increased significantly as the length of stay increased [21].

### COMPARE STRESS LEVEL BETWEEN MOTHERS AND FATHERS

In the NICU, we compared the stress levels in mothers and fathers and the study revealed that mothers' stress levels were higher than fathers. [Refer Table: 6] This conclusion could be based on the fact that mothers spent a lot more time in the NICU's mechanical environment and experienced more anxiety over their child's disability. It's also possible to conclude that mothers are more concerned than fathers about their newborns' behavior and appearance. For the same reason, mothers have been reported to be more stressed than fathers in several studies [21,14,22,23,24,25].

### CONCLUSION

In this study, mothers' stress levels are significantly higher in the NICU when they have a higher socioeconomic status, a higher education level, or a stay of more than 6 days, however, fathers' stress levels are not significantly higher. Psychological Counseling sessions in the NICU to help parents cope with depression, anxiety, and stress associated with preterm birth. Improved parental psychological support has the potential to improve both the parent–infant bond and the developmental outcomes of preterm infants.

### REFERENCES

1. World Health Organization. definition of preterm birth. [Internet] Available from: <https://www.who.int/news-room/fact-sheets/detail/preterm-birth>
2. Walani SR. Global burden of preterm birth. International Journal of Gynecology & Obstetrics. 2020 Jul;150(1):31-3.
3. OakBend Medical Center's Neonatal Intensive Care Unit. Consequences of preterm birth. [Internet] Available from: <https://www.oakbendmedcenter.org/which-babies-need-care-in-the-nicu/Page 6>.
4. Sharma N, Samuel AJ, Aranha VP. Pediatric physiotherapists' role in the neonatal intensive care unit: Parent and health-care providers' perspectives. Journal of Clinical Neonatology. 2018 Jul 1;7(3):111.
5. Williams KG, Patel KT, Stausmire JM, Bridges C, Mathis MW, Barkin JL. The neonatal intensive care unit: Environmental stressors and supports. International journal of environmental research and public health. 2018 Jan;15(1):60.
6. Abdeyazdan Z, Shahkolahi Z, Mehrabi T, Hajiheidari M. A family support intervention to reduce stress among parents of preterm infants in the neonatal intensive care unit. Iranian journal of nursing and midwifery research. 2014 Jul;19(4):349.
7. Craig JW, Glick C, Phillips R, Hall SL, Smith J, Browne J. Recommendations for involving the family in developmental care of the NICU baby. Journal of Perinatology. 2015 Dec;35(1):S5-8.
8. Saleem SM. Modified Kuppuswamy socioeconomic scale updated for the year 2019. Indian J Forensic Community Med. 2019 Jan;6(1):1-3.
9. American Psychological Association. Children, Youth, Families Socioeconomic Status, [Internet] Available from: <https://www.apa.org/pi/ses/resources/publications/children-families>
10. Wikipedia contributors. Socioeconomic Status, [Internet] Available from: [https://en.wikipedia.org/wiki/Socioeconomic\\_status](https://en.wikipedia.org/wiki/Socioeconomic_status)





**Shweta Desai et al.,**

11. Browne JV, Talmi A. Family-based intervention to enhance infant–parentrelationships in the neonatal intensive care unit. *Journal of pediatricpsychology*. 2005 Dec 1;30(8):667-77.
12. Ganguly R, Patnaik L, Sahoo J, Pattanaik S, Sahu T. Assessment of stress among parents of neonates admitted in the neonatal intensive care unit of atertiary care hospital in Eastern India. *Journal of Education and HealthPromotion*. 2020;9.
13. Enlow E, Faherty LJ, Wallace-Keeshen S, Martin AE, Shea JA, Lorch SA. Perspectives of low socioeconomic status mothers of premature infants. *Pediatrics*. 2017 Mar 1;139(3).
14. Carter JD, Mulder RT, Darlow BA. Parental stress in the NICU: The influenceof personality, psychological, pregnancy, and family factors. *Personality and mental health*. 2007 Jun;1(1):40-50.
15. Nomaguchi K, Johnson W. Parenting stress among low-income and working-class fathers: The role of employment. *Journal of family issues*. 2016Aug;37(11):1535-57.
16. Geng L., Xue Q., Chi X., Jia J., Zhou Y., Chen P., et al. (2009). Investigation of maternal parenting stress of mothers with 6-month infants. *J. Clin.Psychiatry* 19 16–18.
17. Dudek-Shriber L. Parent stress in the neonatal intensive care unit and the influence of parent and infant characteristics. *American Journal of Occupational Therapy*. 2004 Sep 1;58(5):509-20.
18. Rajgariah R, Chandrashekarappa SM, Babu KV, Gopi A, Ramaiha NM, Kumar J. Parenting stress and coping strategies adopted among working andnon-working mothers and its association with socio-demographic variables: Across-sectional study. *Clinical Epidemiology and Global Health*. 2021 Jan1;9:191-5.
19. Glazebrook C, Sheard C, Cox S, Oates M, Ndukwe G. Parenting stress in first-time mothers of twins and triplets conceived after in vitro fertilization. *Fertility and sterility*. 2004 Mar 1;81(3):505-11.
20. Biggs MA, Rowland B, McCulloch CE, Foster DG. Does abortion increasewomen's risk for post-traumatic stress? Findings from a prospective longitudinal cohort study. *BMJ open*. 2016 Jan 1;6(2):e009698.
21. Ionio C, Mascheroni E, Colombo C, Castoldi F, Lista G. Stress and feelings inmothers and fathers in NICU: Identifying risk factors for early interventions. *Primary health care research & development*. 2019;20.
22. Palma IE, Von Wussow KF, Morales BI, Cifuentes RJ, Ambiado TS. Stress inparents of hospitalized newborns in a neonatal intensive care unit. *Revistachilena de pediatria*. 2017 Jun 1;88(3):332-9
23. Sikorova L, Kucova J. The needs of mothers to newborns hospitalized inintensive care units. *Biomed Pap Med FacUnivPalacky Olomouc CzechRepub*. 2012 Dec 12;156(4):330-6.
24. Miles MS, Funk SG, Kasper MA. The stress response of mothers and fathersof preterm infants. *Research in Nursing & Health*. 1992 Aug;15(4):261-9
25. Doering L, Moser D, Dracup K. Correlates of anxiety, hostility, depression, and psychosocial adjustment in parents of NICU infants. *Neonatal Network*.2000 Aug 1;19(5):15-23.

**Table 1: Baseline characteristic for birth weight (in grams), parents' age & gestational weeks**

VARIABLES	N	Mean ± SD
Child's birth weight (in grams)	60	1935.15 ± 482.94
Mothers' age		26.43 ± 5.05
Fathers' age		28.4 ± 5.26
Gestational weeks		34.67 ± 2.00

**Table 2: Correlation between different causative factors and level of stress in Mothers**

CATEGORIES	VARIABLES	N	Mother (Mean ± SD)	df	p Value
Socioeconomic condition	Upper	11	2.29 ± 0.68	0.33	0.0252*
	Lower	49	1.96 ± 0.36		
Sex of the child	Male	35	2.09 ± 0.44	0.15	0.1616
	Female	34	1.95 ± 0.44		
Level of education	Higher	8	2.37 ± 0.76	0.0443*	
	Middle	37	1.99± 0.35		
	Illiterate	15	1.91 ± 0.40		





Shweta Desai et al.,

Type of occupation	Working	10	1.91 ± 0.22	0.4098
	Housewife	50	2.04 ± 0.48	
Single or twin preterm child	Single	52	2.01 ± 0.45	-0.05
	Twins	8	2.06 ± 0.44	
Previous history of death/abortion	No death/abortion	44	2.06 ± 0.49	0.15
	Death / abortion	16	1.91 ± 0.26	
Day of sample collection	<=2days	32	1.91 ± 0.25	0.0302*
	3-5days	18	2.04± 0.48	
	>=6days	10	2.33 ± 0.73	

\*Statistically significant (p-value< 0.05); N: no of participants; SD: Standard Deviation; df: Difference

**Table 3: Comparison of Mothers’ Stress and in Detail Level of education**

VARIABLE	df	p Value
Higher - Middle	0.39	0.009**
Higher - Illiterate	0.47	0.010*
Middle - Illiterate	0.079	0.889

\*Statistically significant (p value < 0.05); df: Difference

**Table 4: Comparison of Mothers’ Stress and in Detail Day of Sample Collection**

VARIABLE	df	p Value
3-5days - <=2days	0.14	0.574
>=6days - <=2days	0.42	0.028*
>=6days - 3-5days	0.28	0.251

\*Statistically significant (p value < 0.05); df: Difference

**Table 5: Correlation between different causative factors and level of stress in Fathers**

CATEGORIES	VARIABLES	N	FATHER (Mean ± SD)	df	p Value
Socioeconomic condition	Upper	11	1.79 ± 0.31	0.07	0.6287
	Lower	49	1.72 ± 0.47		
Sex of the child	Male	35	1.76 ± 0.39	0.08	0.4226
	Female	34	1.68 ± 0.46		
Level of education	Higher	15	1.77 ± 0.317	0.0741	
	Middle	40	1.77 ± 0.48		
	Illiterate	5	1.3 ± 0.19		
Type of occupation	Others	35	1.81 ± 0.47	0.0885	
	Elementary	25	1.61 ± 0.37		
Single or twin preterm child	Single	52	1.74 ± 0.46	0.09	0.5810
	Twins	8	1.65 ± 0.33		
Previous history of death / abortion	No death / abortion	44	1.75 ± 0.43	0.067	0.6004
	Death/abortion	16	1.68 ± 0.50		
Day of sample collection	<=2days	32	1.71 ± 0.50	0.9244	
	3-5days	18	1.77 ± 0.40		
	>=6days	10	1.71 ± 0.35		

\*Statistically significant (p-value< 0.05); N: no of participants; SD: Standard Deviation; df: Difference





Shweta Desai *et al.*,

**Table 6: Comparison between Mothers' and Father's stress levels**

GROUP	N	Mothers	Fathers	df	p Value
Pre-Mean ± SD	60	2.01 ± 0.45	1.73 ± 0.44	0.29	<b>0.0006**</b>

\*Statistically significant (p-value< 0.05); N: no of participants; SD: Standard Deviation; df: Difference





## Formulation and Characterization of Mucoadhesive Buccal Tablets of Aceclofenac

Ch. Shanthi priya<sup>1\*</sup>, Sara Ayesha Shabbeer<sup>2</sup> and S. Rohini Reddy<sup>1</sup>

<sup>1</sup>Associate Professor, Department of Pharamaceutics, Sarojini Naidu Vanita Pharmacy Maha Vidyalaya, (Affiliated to Osmania University) Telangana, India.

<sup>2</sup>Student, Department of Pharamaceutics, Sarojini Naidu Vanita Pharmacy Maha Vidyalaya, (Affiliated to Osmania University) Telangana, India.

Received: 22 Jan 2024

Revised: 09 Feb 2024

Accepted: 03 May 2024

### \*Address for Correspondence

**Ch. Shanthi priya**

Associate Professor,  
Department of Pharamaceutics,  
Sarojini Naidu Vanita Pharmacy Maha Vidyalaya,  
(Affiliated to Osmania University)  
Telangana, India.  
Email: shanthipriyapharma@gmail.com



This is an Open Access Journal / article distributed under the terms of the **Creative Commons Attribution License** (CC BY-NC-ND 3.0) which permits unrestricted use, distribution, and reproduction in any medium, provided the original work is properly cited. All rights reserved.

### ABSTRACT

This project is designed to develop and characterize aceclofenac buccal mucoadhesive tablets using various amounts of the three polymers Hydroxypropyl methylcellulose E 15, Polyvinyl pyrrolidone K 30, and Carbopol 940p. Physicochemical characteristics such as hardness ( $8.22 \pm 1.32$  to  $11.34 \pm 1.06$  kg), weight variation ( $249.50 \pm 2.71$  to  $252.53 \pm 2.30$  mg), friability (0.04 to 0.20 %), diameter of the tablet (9.00 mm), thickness test ( $3.97 \pm 0.00$  to  $4.05 \pm 0.04$  mm), and drug content ( $97.44 \pm 1.2$  to  $99.03 \pm 0.7\%$ ) were within the Indian Pharmacopeia's permissible range. According to the results, the swelling index at 8 hr within the range of  $62.19 \pm 0.19$  to  $75.18 \pm 0.12\%$ . Surface pHs of all the formulations are between  $6.76 \pm 0.2$  to  $6.94 \pm 0.4$ . Ex-vivo mucoadhesive time ( $366 \pm 2.6$  to  $540 \pm 2.1$ ) was varied when polymer concentrations changed, particularly of HPMC E 15. Every batch had a very different dissolution profile, with a maximum release of 98.28% (in F3 at 10 hr) to a minimum release of 82.12% (in F7 at 10 hr). Among all formulations, only F3 ensured effective and sustained drug release (98.28% by 10 hr) with a suitable swelling index (75.18%) in addition Ex vivo mucoadhesive time (540 min). Analysis using Fourier Transform Infrared Spectroscopy did not tell any interaction among the drug excipients.

**Keywords:** Aceclofenac, Mucoadhesive tablets, Ex vivo mucoadhesive time, Swelling index, Sustained drug release.





## INTRODUCTION

Various routes of drug administration are employed for different pharmaceutical dosage forms, including parenteral, topical, and oral routes. The oral route is often the most preferred and convenient for drug administration. However, this route presents certain drawbacks, such as drug inactivation due to the hepatic first-pass effect and drug degradation by gastrointestinal tract enzymes. These factors can impede drug absorption, resulting in poor bioavailability of active drugs and the formation of therapeutically inactive drug molecules [1]. Recent advancements in pharmaceutical sciences have introduced innovative approaches to circumvent first-pass metabolism, and the buccal route has emerged as a particularly promising option. The buccal mucosa, located within the oral cavity, proves to be a potential site for the delivery of drugs directly into the systemic circulation. By administering a drug through the buccal mucosa, it enters the systemic circulation with minimal exposure to the first-pass hepatic metabolism and avoids the adverse effects associated with the gastrointestinal tract. The buccal cavity possesses ideal characteristics for drug absorption, making it an excellent site for drug absorption and delivery. Consequently, the buccal route holds significant potential for improving the bioavailability and therapeutic efficacy of drugs [2,3]. The mucosa of the mouth is very different from the rest of the gastrointestinal tract and morphologically is more similar to skin. Although the permeability of the skin is widely regarded as poor, it is not generally appreciated that the oral mucosa lacks the good permeability demonstrated by the intestine. These differences within the gastrointestinal tract can largely be attributed to the organization of the epithelia, which serve very different functions. A simple, single-layered epithelium lines the stomach, small intestine, and colon, which provides a minimal transport distance for absorbents. In contrast, a stratified or multi-layered epithelium covers the oral cavity and oesophagus and, in common with skin, is composed of layers with varying states of differentiation or maturation evident on progression from the basal cell layer to the surface. Drugs have been applied to the oral mucosa for topical applications for many years. However, recently there has been interest in exploiting the oral cavity as a portal for delivering drugs to systemic circulation[4,5].

### Aim

To develop, formulate, characterize, and evaluate the aceclofenac buccal mucoadhesive tablets manufactured by direct compression.

### Objective

To emphasize the primary factors that impact mucoadhesive properties of buccal tablets, such as polymer selection and formulation techniques. To provide an overview for developing mucoadhesive buccal tablets. To optimize successful mucoadhesive buccal tablet products by various evaluation tests. To know the current challenges and opportunities for developing mucoadhesive buccal tablets. To highlight the potential advantages of mucoadhesive buccal tablets over other dosage forms for targeted drug delivery[6,7].

## MATERIALS AND METHODS

### Preparation Method of Calibration Curve

#### pH Phosphate buffer preparation

Dissolve 2.38 grams of sodium hydrogen phosphate, 0.19 grams of potassium dihydrogen phosphate, also 8.0 grams of sodium chloride into water to yield 1000 milliliters.[8]

### Preparation of solutions for Calibration curve

**Stock I:** To make a stock medium of aceclofenac, dissolve 100 milligrams of the drug in 100 milliliters of ethanol in a volumetric flask of 100 ml (resulting in drug media of 1000 µg/ml) and sonicate for a more 10 minutes.

**Stock II:** stock media I of 5ml amount is diluted to 50ml by pH 7.4 phosphate buffer to acquire a stock media II(100 µg/ml of drug). To get rid of any foreign particles, Using Whatmann filter paper, the stock solution was filtered.







Shanthy priya et al.,

**Dilutions**

Individual 0.2ml, 0.4ml, 0.6ml, 0.8ml, and 1ml samples were taken in separate test tube, and add pH 7.4 phosphate buffer to prepare entire amount of 10 ml to yield 2, 4, 6, 8  $\mu\text{g/ml}$ , 10  $\mu\text{g/ml}$  [9,10].

**Acetofenac calibration graph preparation**

Phosphate buffer pH 7.4 sourced to generate the standard solutions for the drug at concentrations of 2, 4, 6, 8  $\mu\text{g/ml}$ , and 10  $\mu\text{g/ml}$  from the stock media. To determine the linearity and regression equation, a standard graph is created between they-axis represents absorbance, and the x-axis represents drug concentration ( $\mu\text{g/ml}$ ). The absorbance of media containing pure Acetofenac is measured at 275  $\lambda_{\text{max}}$ .

**Formulation of Mucoadhesive Tablets of Acetofenac**

Acetofenac mucoadhesive tablets manufactured by already used method with a slight modification. Powders were weighed according to formula. API was then blended with HPMC E15, Carbopol 940P and PVP K 30 are mixed in separate pouch with talc. Using a 40-mesh sieve, these mixtures were blended for five minutes. Magnesium stearate was then added, and the mixture was again mixed before being compressed using a sixteen-station tablet punch to yield tablets with an average weight of 200 mg. From F1 to F8, eight batches were prepared and coded.

**RESULTS AND DISCUSSION: AUTHENTICATION STUDIES****Determination of Melting Point:**

The determination of melting point was done using the capillary method to be around 153°C. This was within limits as per the literature. This confirms the purity of the drug substance.

**Solubility:** Solubility study was performed in PH 7.4 phosphate buffer and ethanol.

**Standard graph of acetofenac**

The standard curve was prepared by UV spectrophotometer. The extreme absorption was detected near 275 nm. The UV procedure was used to determine the standard plot of the acetofenac in pH 7.4 phosphate buffer. Acetofenac calibration curve was plotted using the X and Y-axis for concentration and absorbance, and the graph falls linearly as per limits. Acetofenac calibration curve proved good linearity, having an R<sup>2</sup> of 0.9996

**FTIR (Drug -Excipient compatibility) studies**

FTIR (Drug -Excipient compatibility) spectroscopy is a valuable instrument for analyzing drug-excipient interactions (Shimadzu). FTIR spectrum of acetofenac and acetofenac + HPMC are observed. This demonstrates that the drug and the used polymers are not compatible chemically. The materials used for the research are real, and there were no probable interactions, according to the occurrence of peaks at the predicted selection of values. Indicating the drug-polymer do not interact and confirming the stability of the drug is through the presence of acetofenac in the physical mixture.

**Precompression Studies****Preformulation parameters of powder mixture**

A blend of tablet powder was pre-formulated according to several specifications. According to Angle of Repose readings, the powder mixture exhibits good flow characteristics. The formulations bulk densities (gm/ml) ranged from 0.425 and 0.461, and the powder blend had satisfactory flow characteristics. The formulations tapped densities (gm/ml), which range from 0.475 and 0.516, indicate that the powder has excellent flow properties. The Hausner's ratio for each formulation was discovered to be between 1.04 and 1.16. The compressibility indices of all formulations were less than 12.37; powder indicates satisfactory flow properties. The Angle of Repose for each formulation was between  $24.17 \pm 0.28$  and  $27.41 \pm 0.11$ , suggesting the flow characteristics of the powder are satisfactory.





Shanthy priya et al.,

**Evaluation of Aceclofenac Buccal Mucoadhesive Tablets**

Mucoadhesive buccal tablets of aceclofenac are evaluated for their hardness of tablet, wt. variation, tablet thickness, percentage Friability, pH of Surface, Drug content determination, Swelling index, Ex vivo mucoadhesive time, and *in-vitro* dissolution studies using standard procedure. Results were done in triplicate, and values were reported. Weight variation was to be in the range of  $249.50 \pm 2.71$  to  $252.53 \pm 2.30$  were found within limits. All the formulations of friability in range of 0.04 to 0.20 were found within limits. Results of hardness of all the formulations was found to be in average of  $8.22 \pm 1.32$  to  $11.34 \pm 1.06$  were found within limits. Results of thickness of all the formulations was found to be  $3.97 \pm 0.00$  to  $4.05 \pm 0.04$  were found within limit. Results were done in triplicate and values were reported. All formulation's surface pH was in the range of  $6.76 \pm 0.2$  and  $6.94 \pm 0.4$ . Swelling Index of all the formulations was found to be in the range of  $62.19 \pm 0.19$  to  $75.18 \pm 0.12$ . F1-F8 formulations are conducted with Ex-vivo mucoadhesive time; results found to be in the limits of  $366 \pm 2.6$  to  $540 \pm 2.1$  and drug content determination of each formulation are in between of  $97.44 \pm 1.2$  to  $99.03 \pm 0.7$ . All the parameters were found to be within limits.

**In vitro drug release**

Dissolution shows that the results of the formulations (F1-F8) prepared with HPMC E15, Carbopol, and PVP K30 showed drug release for 10 hours. The cumulative drug release maximum and minimum drug release were observed as F3 (98.28%) and F7 (82.12%), respectively. Whereas the prepared formulations with HPMC E 15 quantity of 75 mg (F3) shown the essential drug release as above, that is, extended the percentage cumulative release of the drug is effective for 10 hrs, also demonstrated all-out of 98.28% in 10 hrs with excellent release. The highest drug release (98.28%) in 10 hours led to the conclusion that the F3 formulation was an optimum formulation based on the dissolution data above.

**Kinetics Data for Optimized Formulation****Surface Morphology**

Surface of the mucoadhesive buccal tablet was checked for smoothness and particle size of the tablet granules. It showed the size of 50 microns at magnification 500 x.

**CONCLUSION**

This research was to develop and characterize aceclofenac sustained-release buccal mucoadhesive tablets characteristic in the direction of increasing patient ability for the treatment of different types of pain. By direct compression, different formulations were prepared (F1 to F8) using different concentrations of HPMC E15, PVPK 30 and carbopol 940P. Among eight batches, F3 showed *ex-vivo* mucoadhesive time, swelling index and effective drug release. Similarly, the outcomes demonstrate that HPMC E15 has an important part in improving the potency of the mucoadhesive buccal tablet. Thus, HPMC E15 can be very helpful in monitoring the rate of drug release and swelling behaviour. An effective approach to stop the first-pass metabolism and increase aceclofenac bioavailability across the mucosal membrane is to formulate an aceclofenac mucoadhesive tablet. Additionally, it helps improve patient adherence by captivating the extended drug release. The physicochemical characteristics of the powder blend were evaluated by parameters like hausner's ratio of <1.18, Carr's compressibility index of <13%, and angle of repose of <30°, which yielded satisfactory results showed promising results. The optimized F3 formulation obtained a swelling index of 75.18%, a surface pH of 6.94, and an *in-vitro* cumulative release of drug 98.28%. Ex vivo mucoadhesive time was determined by placing a tablet on freshly cut sheep buccal mucosa, which showed a result of 540 min. The optimized design was categorized by Fourier Transform Infrared Spectroscopy and the study revealed a null reaction among the drug and excipient. It concludes that F3 has shown the optimized results from all the prepared (F1- F8) formulations.





Shanthi priya et al.,

## REFERENCES

- Mario Jug and Mira Becirevic-Lacan (2004). "Influence of hydroxypropyl- $\beta$ -cyclodextrin complexation on piroxicam release from Buccoadhesive tablets," European Journal of Pharmaceutical Sciences. 2004; 21: 251–260.
- Yajaman Sudhakar, Ketousetuo Kuotsu, and A.K. Bandyopadhyay (2006). "Buccal bioadhesive drug delivery, a promising option for orally less efficient drugs: Review". Journal of Controlled Release; 2006; 114: 15-40.
- Ahuja A, Khar RK, Ali J. (1997) Mucoadhesive Drug Delivery Systems. Drug Develop Indus Pharm 1997; 23: 489-515.
- Lieberman HA, Lachman, Schwartz B. (1989) Pharmaceutical Dosage forms: Tablets Volume 1. 2nd ed. New York: Marcel Dekker; 1989.
- Tapash KG and RP William (2005). Drug delivery to the oral cavity, edited by James Swarbrick Published by CRC Press Taylor & Francis Group, Printed in the U.S.A; 2005;1-397.
- Shojaei HA (1998). "Buccal mucosa as a route for systemic drug delivery: A Review". Journal of Pharmaceutical Sciences.1998; 1(1): 15 -30.
- Marcos LB, Osvaldo DF (2005). Oral bioadhesive drug delivery systems. Drug DevIndPharma 2005; 31(3): 293-310.
- Jain. NK (1997). Controlled and Novel Drug Delivery. 1st Edition, New Delhi. 1997; 52-81, 353-380.
- Lesch CA, Squier CA, Cruchley AH (1989). The permeability of human oral mucosa and skin to water. J Dent Res1989; 68:1345–1349.
- Schroeder HE (1981). Differentiation of human oral stratified epithelium. Basel: S Karger, 1981;33.

Table 1: Formulation of Buccal Aceclofenac Mucoadhesive Tablets

S No	Requirements	F1	F2	F3	F4	F5	F6	F7	F8
1	Aceclofenac	50mg	50mg	50mg	50mg	50mg	50mg	50mg	50mg
2	Hydroxy Propyl Methyl Cellulose E15 (mg)	55	60	75	50	70	50	70	75
3	Carbopol 940p (mg)	75	70	55	80	50	70	60	50
4	Poly Vinyl Pyrrolidone K 30 (mg)	10	10	10	10	20	20	10	15
5	Magnesium Stearate (milligrams)	5	5	5	5	5	5	5	5
6	Talc (milligrams)	5	5	5	5	5	5	5	5
	Total (mg)	200	200	200	200	200	200	200	200

Table 2: Determination of melting point

Trials	Observed Melting point	Melting point Average	Melting point Reference
1	149		
2	153	150.3	149-153 <sup>o</sup> c
3	149		

Table 3: Solubility of Aceclofenac

SNO.	Solvents used	Observation
1	Phosphate Buffer Solution-7.4(pH)	Freely solubilized





Shanthi priya et al.,

2	Ethanol	Freely solubilized
---	---------	--------------------

Table 4: Standard Graph of Aceclofenac

Conc. ( $\mu\text{g/mL}$ )	Absorbance(nm)
0	0
2	0.153
4	0.320
6	0.489
8	0.645
10	0.828
12	0.971

Table 5: Aceclofenac FTIR spectra show the following principal bands at a wave number

Functional groups	Wave numbers( $\text{cm}^{-1}$ )
OH group	3735 $\text{cm}^{-1}$
Ester stretching( $-\text{C}=\text{O}$ )	1772 $\text{cm}^{-1}$
Aromatic stretching ( $\text{C}=\text{C}$ )	1506 $\text{cm}^{-1}$

Table 6: Pre formulation parameters of powder mixture

Formulation code	Angle of repose ( $\theta$ )	Bulk density ( $\text{gm/cm}^3$ )	Tapped density ( $\text{gm/cm}^3$ )	Carr's index (I)	Hausner's ratio
F1	25.17 $\pm$ 0.23	0.454	0.481	5.61	1.05
F2	26.58 $\pm$ 0.34	0.461	0.516	10.65	1.11
F3	24.17 $\pm$ 0.28	0.425	0.485	12.37	1.16
F4	26.47 $\pm$ 0.25	0.455	0.511	10.90	1.12
F5	25.75 $\pm$ 0.32	0.459	0.494	7.08	1.07
F6	27.11 $\pm$ 0.21	0.456	0.475	4.00	1.04
F7	25.17 $\pm$ 0.22	0.452	0.485	6.80	1.07
F8	27.41 $\pm$ 0.11	0.459	0.504	8.92	1.09

Table 7: Evaluation of Buccal Mucoadhesive Tablets of Aceclofenac

Formulation code	Wt. Variation ( $\text{mg} \pm \text{SD}$ )	Hardness ( $\text{Kg} \pm \text{SD}$ )	Friability (%)	Diameter (mm)	Thickness ( $\text{mm} \pm \text{SD}$ )
F1	248.72 $\pm$ 2.12	9.21 $\pm$ 1.54	0.13	9	3.98 $\pm$ 0.05
F2	249.61 $\pm$ 2.31	8.22 $\pm$ 1.32	0.20	9	4 $\pm$ 0.00
F3	252.53 $\pm$ 2.30	8.89 $\pm$ 0.64	0.09	9	4.02 $\pm$ 0.05
F4	250.55 $\pm$ 1.79	11.34 $\pm$ 1.06	0.07	9	4.05 $\pm$ 0.04
F5	250.45 $\pm$ 1.98	10.12 $\pm$ 1.32	0.04	9	3.9 $\pm$ 0.06
F6	249.72 $\pm$ 2.53	11.15 $\pm$ 1.36	0.11	9	3.97 $\pm$ 0.00
F7	249.50 $\pm$ 2.71	9.74 $\pm$ 1.32	0.05	9	4 $\pm$ 0.00
F8	249.58 $\pm$ 3.17	11.26 $\pm$ 1.34	0.14	9	4 $\pm$ 0.00





Shanthi priya et al.,

Table 8: Evaluation of Aceclofenac Mucoadhesive Buccal Tablets

Formulation code	Surface pH test (±SD)	Swelling index test (%±SD)	Ex-vivo mucoadhesive time (min ±SD)	Drug content determination (%±SD)
F1	6.76± 0.2	67.15 ±0.04	400 ±1.2	97.44 ±1.2
F2	6.82± 0.4	68.28± 0.34	480 ±1.5	97.57± 0.5
F3	6.94 ±0.1	75.18 ±0.12	540 ±2.1	99.03± 0.7
F4	6.88 ±0.2	70.89 ±0.21	460 ±1.4	98.00 ±1.2
F5	6.82± 0.11	71.90 ±0.56	395 ±2.5	98.59 ± 1.5
F6	6.80 ± 0.25	67.54 ±0.25	410 ±1.4	98.94 ± 1.3
F7	6.94 ±0.4	67.46 ±0.12	385 ±1.5	97.46±1.12
F8	6.82 ± 0.29	62.19 ±0.19	366 ±2.6	97.59±1.21

Table 9: In-vitro dissolution of aceclofenac mucoadhesive buccal tablets

FORMULATION CODE	TIME (hr)							
	0	0.5	1	2	4	6	8	10
F1	0	9.92±0.2	14.84±0.25	22.23±0.23	27.44±0.36	43.42±0.15	68.31±0.22	93.01±0.16
F2	0	8.45±0.12	11.75±0.55	16.23±0.18	18.26±0.35	42.2±0.13	67.3±0.35	91.68±0.15
F3	0	11.15±0.56	16.12±0.11	26.45±0.19	35.3±0.34	55.45±0.17	78.78±0.37	98.28±0.13
F4	0	8.67±0.11	14.45±0.25	23.52±0.17	28.45±0.33	47.17±0.18	70.32±0.28	94.37±0.22
F5	0	8.53±0.14	13.78±0.74	20.84±0.16	26.71±0.12	48.53±0.19	68.23±0.44	90.25±0.21
F6	0	8.92±0.11	13.84±0.13	21.23±0.17	26.42±0.18	42.4±0.22	70.21±0.35	92.59±0.35
F7	0	7.67±0.25	13.12±0.89	25.42±0.54	29.21±0.59	45.45±0.11	70.78±0.54	82.12±0.45
F8	0	8.42±0.26	11.87±0.54	18.48±0.22	24.14±0.67	45.35±0.15	65.32±0.58	87.52±0.55

Table 10: Data on kinetics for optimized formulation

	DRUG RELEASE KINETICS				
	ZERO ORDER	HIGUCHI	PEPPAS	FIRST ORDER	Hixson Crowell
	1	2	3	4	5
	R(Cv/s T)	R(Cv/s Root(T))	Log T v/s Log C	T v/s LOG % REMAINING	TV/s (Q1/3-Qt1/3)
Slope	0.712	-0.448	172.918	1.000	0.249
Correlation	0.9879	-0.7816	0.9687	0.9879	0.9881
R 2	0.9759	0.6109	0.9384	0.9759	0.9764

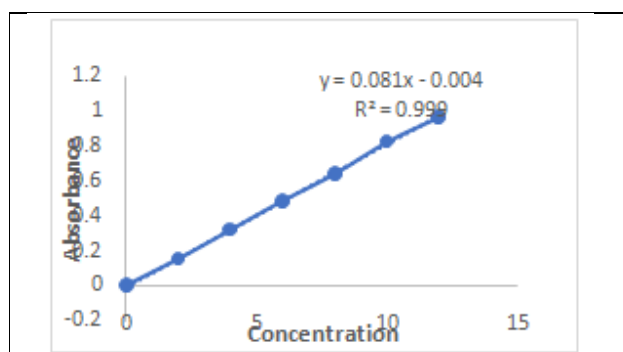


Figure 1: Standard graph of aceclofenac

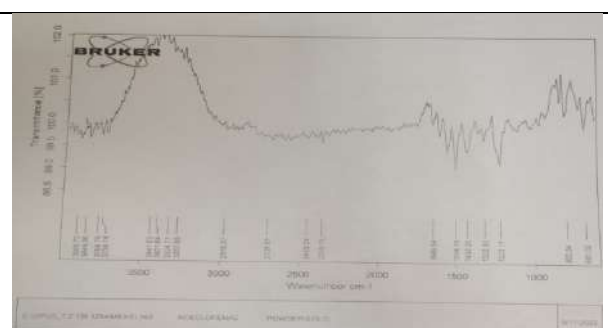


Figure 2: FTIR Spectra of Aceclofenac





Shanthi priya et al.,

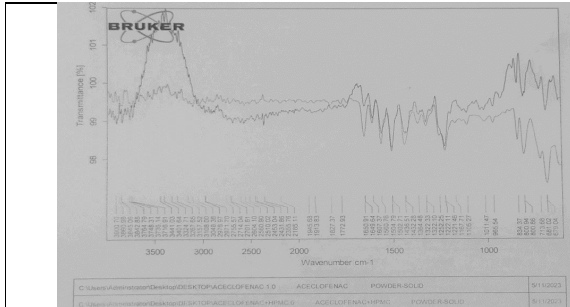


Figure 3: FTIR Spectra of Aceclofenac + HPMC

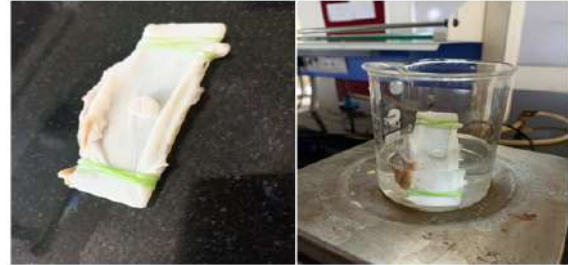


Fig 4: EX-VIVO MUCOADHESION STUDIES

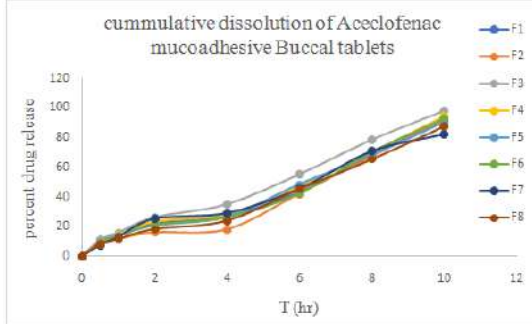


Figure 5: Comparing the F1 to F8 formulations *in-vitro* cumulative drug release profiles

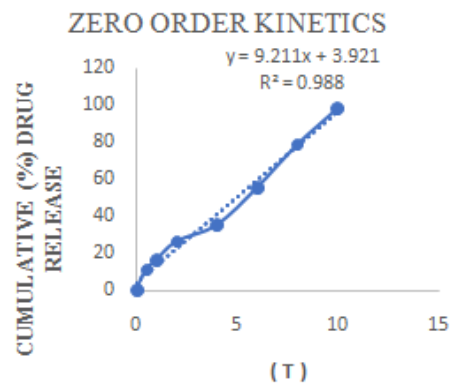


Fig 6: Release kinetics of zero order

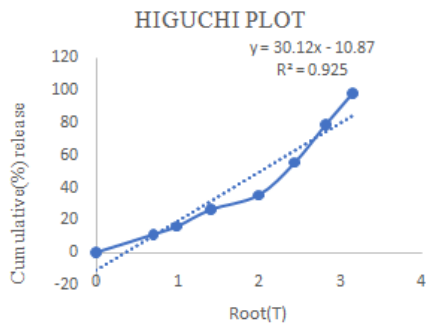


Fig 7: Higuchi release kinetics

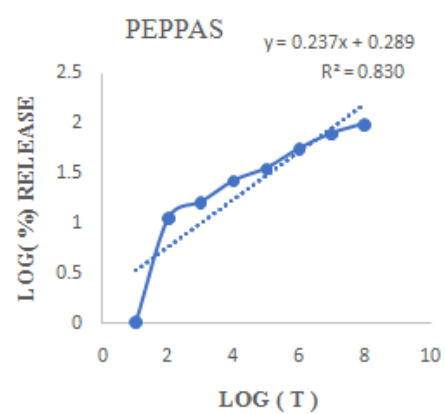
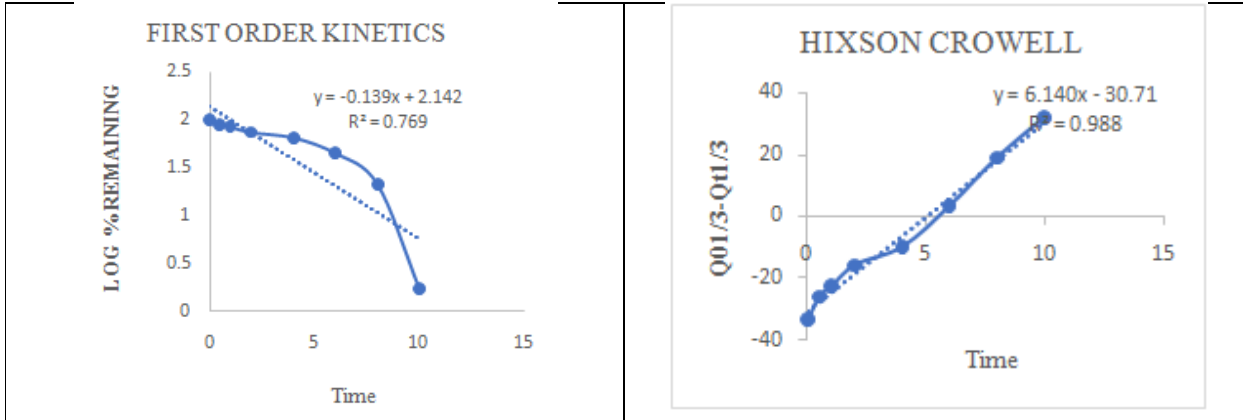


Fig 8: Kors mayer peppas release kinetics



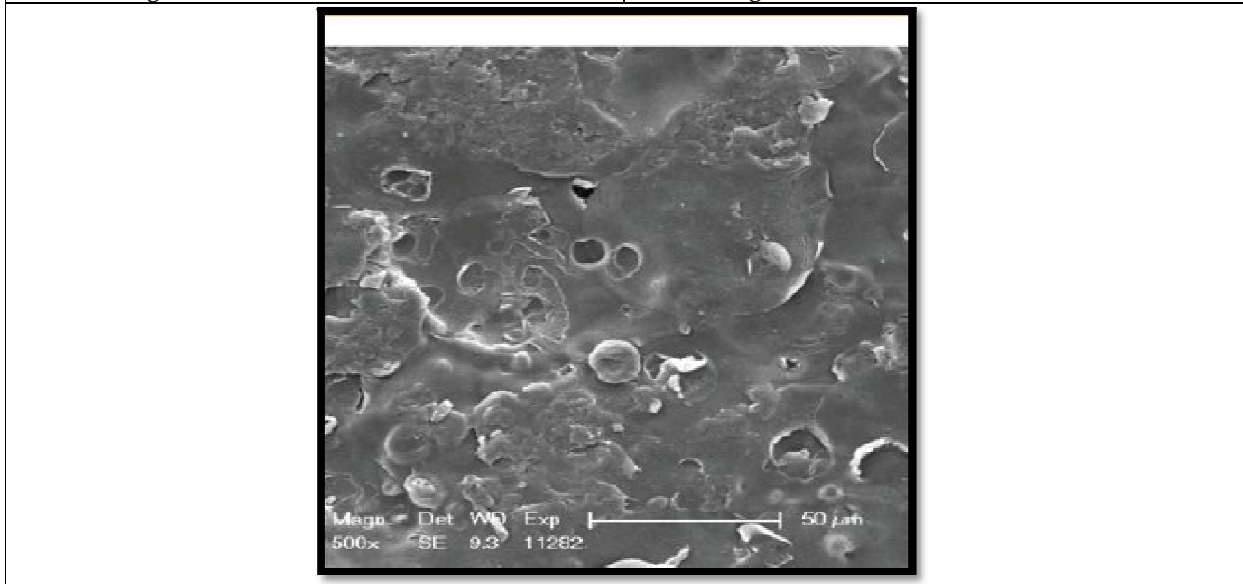


**Shanthy priya et al.,**



**Fig 9: Release kinetics of first order**

**Fig 10: Hixson Crowell release kinetics**



**Fig 11: Surface Morphology**





## A Pilot Study on Medication Burden, Complexity and Adherence among Type – 2 Diabetes Patients

Helen W<sup>1\*</sup> and Srinivasan R<sup>2</sup>

<sup>1</sup>Research Scholar, Department of Pharmacy Practice , Faculty of Pharmacy, Bharath Institute of Higher Education and Research (BIHER), Chennai, Tamil Nadu, India.

<sup>2</sup>Research Supervisor, Department of Pharmaceutical Chemistry, Faculty of Pharmacy, Bharath Institute of Higher Education and Research (BIHER), Chennai, Tamil Nadu, India.

Received: 22 Jan 2024

Revised: 09 Feb 2024

Accepted: 27 Apr 2024

### \*Address for Correspondence

**Helen W**

Research Scholar,  
Department of Pharmacy Practice,  
Faculty of Pharmacy,  
Bharath Institute of Higher Education and Research (BIHER),  
Chennai, Tamil Nadu, India.  
Email: whelen2712@gmail.com



This is an Open Access Journal / article distributed under the terms of the **Creative Commons Attribution License** (CC BY-NC-ND 3.0) which permits unrestricted use, distribution, and reproduction in any medium, provided the original work is properly cited. All rights reserved.

### ABSTRACT

Diabetes is a chronic condition that needs to be treated medically for a long time. The medication regimen complexity index used to quantify the complexity of a medication regimen. Medication burden focuses on the unpleasant experiences that come with receiving therapy and medication adherence is the degree to which the person's behaviour corresponds with the agreed recommendations from a health care provider. There are several factors that contribute to medication complexity, burden and adherence but not many studies have been conducted to explore it. To assess the medication complexity, burden, adherence and also determine the time taken for completing each burden, adherence and complexity questionnaire among type 2 diabetes mellitus patients. A cross-sectional observational pilot study was conducted among 50 type 2 diabetes mellitus patients for the period of 2 months (July –August 2023). Majority were females from age group 55-64 years under biguanides anti diabetic medication. Overall, the average medication count was 4.2 with MRCI score with high burden and moderate medication adherence. And participants took 32 minutes for completion of each questionnaire. The elaborated findings of medication regimen, burden and adherence to facilitate self-care for patients with type 2 diabetes mellitus and to attain the best possible results.

**Keywords:** Type 2 diabetes patients, Medication burden, Complexity, Adherence, Pilot study







## INTRODUCTION

Diabetes is a chronic condition that needs to be treated medically for a long time. When lifestyle changes are not enough to control blood sugar levels, patients are typically prescribed medications. People with type 2 diabetes mellitus (T2DM) frequently need to take multiple medications, and the complexity of these regimens increases as the condition worsens and complications develop[1-2]. The World Health Organization estimates that 77 million Indians over the age of 18 have type 2 diabetes, and another 25 million are prediabetics, indicating they have a higher chance of getting the disease in the near future. More than half of the population are unaware that they have diabetes, which can cause health issues if it is not identified and treated promptly. Heart attacks and strokes are two to three times more common in adults with diabetes. Neuropathy (nerve damage) in the feet increases the risk of infection, foot ulcers, and the eventual necessity for limb amputation when combined with decreased blood flow. Thus, a deeper comprehension of treatment profiles is necessary before appropriate interventions can be aimed at improving T2DM patients' medication-taking practices.[3,4] The Medication Regimen Complexity Index (MRCI), a validated measure, can be used to quantify the complexity of a medication regimen. The number of medications, recommended dosage forms, frequency of dosages, and administration instructions are among the medication aspects that determine the level of complexity of the regimen. By differentiating between regimens with the same number of medications but varying in complexity, the MRCI tool has proven to be a useful tool for classifying medication regimen complexity when compared to a simple medication count. subsequently, this tool was extended and verified to incorporate prescription drugs specific to a given ailment as well as additional prescription and over-the-counter (OTC) treatments. When patients are most at danger of not achieving desired results, the enlarged tool—known as patient-level MRCI—offers a superior viewpoint. The term "medication-related burden" (MRB) refers to a relatively new idea that focuses on the unpleasant experiences that come with receiving therapy.

It is a component of treatment burden that encompasses the cost of the drug as well as all other forms of healthcare interventions and the viewpoint of the patient regarding MRB. Medication-related burden can impact social functioning, psychological health, patient satisfaction, and quality of life in addition to causing non-adherence and unsatisfactory clinical results. Because they are bothered by their illness as well as their ever-expanding healthcare regimens, patients may suffer a lower quality of life as they devote more of their time, energy, and resources to maintaining well.[6-8] Patients who feel burdened may find it difficult to take their prescribed drugs and receive the care they need, but their burden may also have an impact on their health. Individuals who have multiple medical conditions and a heavy treatment load might not take their prescription drugs as directed. In order to understand how patients feel about their personal experiences and care outcomes, including the advantages and disadvantages of therapy, patient-reported experience measures and patient-reported outcome measures are essential. Based on the literature search, many studies were conducted in assessment of burden, adherence and MRCI, but failed to report the sensitive issue on time taken for completing each burden, adherence and MRCI questionnaire by the type 2 diabetes mellitus patients considering the patients valuable time. Therefore, as a part of PhD work, the study was aimed to assess the medication complexity, burden, adherence and also determine the time taken for completing each burden, adherence and complexity questionnaire among type 2 diabetes mellitus patients.[10,12]

## MATERIALS AND METHODS

A cross-sectional observational pilot study among 50 type 2 diabetes mellitus patients for the period of 2 months (July –August 2023). The study was approved by the institutional ethics committee. Every procedure used in this investigation that involved human participants complied with the 1964 Helsinki Declaration. Both male and female on age above 18 years in OP & IP departments with duration of type 2 diabetes more than one year were included in this study. Any chronic illness, type 1 and gestational diabetes mellitus, inability to communicate due to mental or physical disability were excluded from this study. Data were collected from patient files (MRCI) and by directly questioning the patients. The time is recorded individually for answering each questionnaires and noted. A variety





### Helen and Srinivasan

of prior literatures were explored in the development of the data gathering questionnaire. The information included the socio-demographic details (Age, Gender, Professional status, types of diabetes, duration of disease, smoking, Alcohol consumption, control of blood pressure levels, Concomitant diseases), Living with medicines version 3 questionnaire and morisky medication adherence scale -4.

#### Study Plan

##### Data collection tools

##### Medication complexity

Medication regimen complexity is measured by the validated 65-item MRCI, which takes into account the number of medications, dosage form, frequency of administration, and other instructions (such when to take the tablets, how they interact with meals and drinks, and whether to crush or break them). The three sections of the tool are as follows: section A addresses the method of administering medication, section B addresses the frequency of dosing, and section C addresses extra instructions. The three sections' results (A + B + C) are added to obtain a complexity index. The complexity of drug regimens was divided into three categories: low, moderate, and high. The tool's IQR recommendation serves as the basis for the cutoff point. There are three levels of complexity: low (<15), medium (16–20), and high (20 or more) MRCI complexity.

##### Medication burden

The burden associated with taking medications was measured using the 41-item Living with Medicines Questionnaire (LMQ). This measure included a 5-point Likert scale with the options (1) Strongly agree, (2) Agree, (3) Neutral, (4) Disagree, and (5) Strongly disagree. A composite score for each of the 41 items on the LMQ-3, with a possible range of 41 to 205, was used to get the overall score. Before the scores were calculated, all statements with negative wording were reverse coded. There were five categories used to categorize the level of medication-related burden: minimal (74–106), moderate (107–139), high (140–172), and extreme (173–205).

##### Treatment Adherence

The 4-item Morisky Medication Adherence Scale was used to measure treatment adherence. A 4-item self-report assessment of a patient's adherence to medicine is called the MMAS-4. Higher scores indicate more adherence. The overall score range is 0 to 4.

##### Statistical analysis

The data collected was presented on a spreadsheet using SPSS software program version 13. The frequency (count) for the specific variable and its percentage of occurrence within all patients were calculated.

## RESULTS

As shown in Table 1, from the total 50 patients, the majority were female (56%), age group 55-64 years (36%), literate (78%), employed (72%), were from lower-middle class (66%), takes healthy diet (40%) and majority were non-alcoholic and smoker (64 and 80%). In clinical characteristics, most of the respondents doesn't have comorbidities and diabetic complications (44% and 52%), 6-10 years of diabetes presence (60%), controlled diabetes (60%), more than two prescribed medications (58%), takes both tablet and injection medication form (42%) and 52% of respondents spends >5000 rupees for medication monthly. Equal number of patients were retrieved from private and government hospitals. All variables are statistically significant. Figure 1, shows percentage of the classes of anti-diabetic drugs treatment utilized among study participants. Among anti-diabetic medications, biguanides classes of drugs (58%) were mostly prescribed. Table 2, depicts the relationship between the treatment regimens and achieving adequate glycemic control (HbA1c  $\leq$  7.0%). Every model was executed independently and covariate-corrected. Increasing the number of medications taken (adjusted OR 0.88; 95% CI 0.82–0.94) and complexity of the regimen (adjusted OR 0.89; 95% CI 0.87–0.92) was related to a reduced chance of reaching a HbA1c  $\leq$  7.0% for patient-level assessment (other medications). Table 3 shows the overall LMQ (medication burden) score and adherence score





### Helen and Srinivasan

showed a significant high perceived burden and moderate adherence among respondents. Figure 2, represents the time taken by the participants such that for informed consent (10 minutes), sociodemographic and clinical characteristics (4 minutes), LMQ questionnaire (15 minutes) and MMAS questions (3 minutes). Totally the participants took 32 minutes for overall completion of the questions.

## DISCUSSION

About 90 to 95 percent of all cases of diabetes that are identified are type 2 diabetes, which makes up the majority of the diabetic cases in the study. About two-thirds of the individuals in this study took more than two drugs every day on average. More than 50% of the patient-level MRCI score was accounted for by the diabetes-specific MRCI. According to similar research conducted in Malaysia, during the course of the 3-month follow-up period, poor glycemic control was linked to high drug count, high regimen complexity, and low medication adherence. This study showed a modest rate of medication adherence, despite the significant number of patients with a high drug load. This observation could be explained by a number of factors. Firstly, it is plausible that the adherence seen in this study continues to be strong up until a particular drug burden threshold is reached, at which point it may begin to decrease. Previous research shown that a patient may only be able to regularly take a certain amount of prescription drugs as directed. The adherence measure is the second.[14]

For some patients, this restriction might exaggerate adherence to treatment. Finally, patients' health beliefs about efficient illness care may have a role in successful adherence. According to this health belief model, patients who think they are sick are probably going to go above and beyond to take their prescription drugs on time in order to stay well. Notably, taking medications as prescribed is a complicated behaviour. It can be affected by a patient's own beliefs, understanding about the importance of the prescription they are prescribed, as well as their personal traits and the ways in which they try to remember to take their medication as directed.[15,16] However, high pharmaceutical burden also raises the possibility of drug interactions and possibly improper medication use. Consequently, if feasible, attempts to reduce the burden associated with medicine should be taken into consideration. These include choosing drugs that address several underlying conditions, combining indications with a single medication, or using fixed-dose combination pharmaceuticals (FDC). This study's total MRCI score was identical to that of an earlier investigation that focused on T2DM patients and used similar criteria, only taking into account chronic drugs that had been filled for at least 90 days. In the current study, the MRCI related to diabetes accounted for more than 50% of the total MRCI score. Previous investigations yielded similar results, with the group with diabetes having a higher MRCI score than the group with hypertension, even though there was no difference in the mean number of drugs. This suggests that, to some extent, the complexity of the antidiabetic drug regimen is influenced by factors other than the total number of drugs taken. Oral and injectable antidiabetic regimens are also possible; adding insulin to the treatment plan raises the regimen's complexity score.

It has previously been shown that the MRCI tool can be used to assess the complexity of pharmacotherapy; however, there is currently conflicting data regarding the proper MRCI score cut-points that can be used to differentiate between different levels of regimen complexity.[18] Therefore, until the range of probable MRCI is determined, meaningful comparisons between research are challenging. Consistent with other research that focused on T2DM patients, the current study's results showed an inverse relationship between good glycemic control and the MRCI score. The fact that non-antidiabetic drugs including lipid-lowering agents and antihypertensive drugs accounted for about 45% of the patient level score should not be overlooked, though. While these medications have been shown to raise the patient-level MRCI score, there is a possibility that some of these medications have unintended effects on glucose levels. For example, it has been documented that even in people without diabetes, non-antidiabetic drugs such salicylates, beta-blockers, and angiotensin-converting enzyme inhibitors can cause medication-induced hypoglycemia.[19,20] As predicted, we discovered that improved glucose control was positively correlated with proper medication adherence. This aligns with findings from other research that demonstrated a positive correlation between increased adherence and better glycemic management. Reducing the frequency of





### Helen and Srinivasan

prescribed drugs is a feasible strategy that can be implemented to mitigate regimen complexity. Medication dosage simplification has been shown to significantly improve adherence, according to reports. For the majority of chronic illnesses, however, an increased drug load can be inevitable. [21] Thus, it is essential to regularly assess patients' pharmaceutical regimens to make sure that superfluous and redundant prescriptions are stopped. The findings of this study have to be considered within several limitations.

#### Study limitations

This study was limited, as it was a pilot, by a participant count that was not quite high enough to yield the anticipated magnitude of the effect. Increasing the sample size might boost statistical power, but it would also be wise to modify the design to reduce contamination and reactivity. This kind of study is very dependent on the information that participants offer and is subject to recollection bias.

### CONCLUSION

There was an inverse relationship found between medication adherence and success in achieving effective glycemic control, while high drug count and complex regimens were linked to decreased probabilities. Additionally, it appears from these data that the relationship between regimen complexity and glycemic control is probably mediated by medication adherence. In order to overcome the complexity that comes with prescribing medication, our study shown that MRCI can be used as an objective proxy. In this way, it can assist in clinical decision support by detecting patients with intricate medication schedules, who can subsequently undergo additional evaluation prior to corrective action being implemented. This study aimed to optimize the time management of consenting patients by highlighting the average time taken by each patient to complete each questionnaire. As, this pilot study is the part of the PhD research, the elaborated findings of medication regimen, burden, closer clinical monitoring and clinical interventions, understanding of prescribed medications will be implemented to facilitate self-care and enhance adherence in people with type 2 diabetes.

### REFERENCES

1. Advinha, A. M., de Oliveira-Martins, S., Mateus, V., Pajote, S. G., and Lopes, M. J. (2014). Medication Regimen Complexity in Institutionalized Elderly People in an Aging Society. *Int. J. Clin. Pharm.* 36 (4), 750–756. doi:10.1007/s11096-014-9963-4
2. Ahmad, N. S., Ramli, A., Islahudin, F., and Paraidathathu, T. (2013). Medication Adherence in Patients with Type 2 Diabetes Mellitus Treated at Primary Health Clinics in Malaysia. *Patient Prefer Adherence* 7, 525–530. doi:10.2147/ppa.s44698
3. Andrade, S. E., Kahler, K. H., Frech, F., and Chan, K. A. (2006). Methods for Evaluation of Medication Adherence and Persistence using Automated Databases. *Pharmacoepidemiol Drug Saf.* 15 (8), 565–574; discussion 575–567. doi:10.1002/pds.1230
4. Ayele, A. A., Tegegn, H. G., Ayele, T. A., and Ayalew, M. B. (2019). Medication Regimen Complexity and its Impact on Medication Adherence and Glycemic Control Among Patients with Type 2 Diabetes Mellitus in an Ethiopian General Hospital. *BMJ Open Diabetes Res. Care* 7 (1), e000685. doi:10.1136/bmjdr-2019-000685
5. Boye, K. S., Mody, R., Lage, M. J., Douglas, S., and Patel, H. (2020). Chronic Medication Burden and Complexity for US Patients with Type 2 Diabetes Treated with Glucose-Lowering Agents. *Diabetes Ther.* 11 (7), 1513–1525. doi:10.1007/s13300-020-00838-6
6. Claxton, A. J., Cramer, J., and Pierce, C. (2001). A Systematic Review of the Associations between Dose Regimens and Medication Compliance. *Clin. Ther.* 23 (8), 1296–1310. doi:10.1016/s0149-2918(01)80109-0
7. Coleman, C. I., Limone, B., Sobieraj, D. M., Lee, S., Roberts, M. S., Kaur, R., et al. (2012). Dosing Frequency and Medication Adherence in Chronic Disease. *J. Manag. Care Pharm.* 18 (7), 527–539. doi:10.18553/jmcp.2012.18.7.527





### Helen and Srinivasan

8. Ferreira, J. M., Galato, D., and Melo, A. C. (2015). Medication Regimen Complexity in Adults and the Elderly in a Primary Healthcare Setting: Determination of High and Low Complexities. *Pharm. Pract. (Granada)* 13 (4), 659. doi:10.18549/PharmPract.2015.04.659
9. George, J., Phun, Y. T., Bailey, M. J., Kong, D. C., and Stewart, K. (2004). Development and Validation of the Medication Regimen Complexity index. *Ann. Pharmacother.* 38 (9), 1369–1376. doi:10.1345/aph.1D479
10. Hasan, S. S., Kow, C. S., Verma, R. K., Ahmed, S. I., Mittal, P., and Chong, D. W. K. (2017). An Evaluation of Medication Appropriateness and Frailty Among Residents of Aged Care Homes in Malaysia: A Cross-Sectional Study. *Medicine (Baltimore)* 96 (35), e7929. doi:10.1097/md.00000000000007929
11. Ho, P. M., Rumsfeld, J. S., Masoudi, F. A., McClure, D. L., Plomondon, M. E., Steiner, J. F., et al. (2006). Effect of Medication Nonadherence on Hospitalization and Mortality Among Patients with Diabetes Mellitus. *Arch. Intern. Med.* 166 (17), 1836–1841. doi:10.1001/archinte.166.17.1836
12. Hussein, Z., Taher, S. W., Gilcharan Singh, H. K., and Chee Siew Swee, W. (2015). Diabetes Care in Malaysia: Problems, New Models, and Solutions. *Ann. Glob. Health* 81 (6), 851–862. doi:10.1016/j.aogh.2015.12.016
13. Ingersoll, K. S., and Cohen, J. (2008). The Impact of Medication Regimen Factors on Adherence to Chronic Treatment: a Review of Literature. *J. Behav. Med.* 31 (3), 213–224. doi:10.1007/s10865-007-9147-y
14. Institute for Public Health (2020). National Health and Morbidity Surevy (NHMS) 2019: Non-communicable Disease, Healthcare Demand, and Health Literacy - Key Findings. Selangor, Malaysia.
15. Lin, L. K., Sun, Y., Heng, B. H., Chew, D. E. K., and Chong, P. N. (2017). Medication Adherence and Glycemic Control Among Newly Diagnosed Diabetes Patients. *BMJ Open Diabetes Res. Care* 5 (1), e000429. doi:10.1136/bmjdr-2017-000429
16. Mafauzy, M., Zanariah, H., Nazeri, A., and Chan, S. P. (2016). DiabCare 2013: A Cross-Sectional Study of Hospital Based Diabetes Care Delivery and Prevention of Diabetes Related Complications in Malaysia. *Med. J. Malaysia* 71 (4), 177–185. <http://www.e-mjm.org/2016/v71n4/diabetes-care.pdf>
17. Mansur, N., Weiss, A., and Beloosesky, Y. (2012). Looking beyond Polypharmacy: Quantification of Medication Regimen Complexity in the Elderly. *Am. J. Geriatr. Pharmacother.* 10 (4), 223–229. doi:10.1016/j.amjopharm.2012.06.002
18. Ministry of Health Malaysia (2015). Malaysian Clinical Practice Guidelines Management of Type 2 Diabetes Mellitus. 5th Edition.
19. Ownby, R. L., Hertzog, C., Crocco, E., and Duara, R. (2006). Factors Related to Medication Adherence in Memory Disorder Clinic Patients. *Aging Ment. Health* 10 (4), 378–385. doi:10.1080/13607860500410011
20. Palleria, C., Di Paolo, A., Giofrè, C., Caglioti, C., Leuzzi, G., Siniscalchi, A., et al. (2013). Pharmacokinetic Drug-Drug Interaction and Their Implication in Clinical Management. *J. Res. Med. Sci.* 18 (7), 601–610.
21. Pantuzza, L. L., Ceccato, M. D. G. B., Silveira, M. R., Junqueira, L. M. R., and Reis, A. M. M. (2017). Association between Medication Regimen Complexity and Pharmacotherapy Adherence: a Systematic Review. *Eur. J. Clin. Pharmacol.* 73 (11), 1475–1489. doi:10.1007/s00228-017-2315-2
22. Pednekar, P. P., Ágh, T., Malmenäs, M., Raval, A. D., Bennett, B. M., Borah, B. J., et al. (2019). Methods for Measuring Multiple Medication Adherence: A Systematic Review-Report of the ISPOR Medication Adherence and Persistence Special Interest Group. *Value Health* 22 (2), 139–156. doi:10.1016/j.jval.2018.08.006

**Table 1. Socio-demographic and clinical characteristics**

Socio-demographic and clinical characteristics	Distribution(N)	Percentage(%)	P value	
Age	≤ 18-24	4	8	0.75
	25-34	5	10	
	35-44	6	12	
	45-54	7	14	
	55-64	18	36	





## Helen and Srinivasan

	≥65	10	20	
Gender	Male	22	44	0.12
	Female	28	56	
Educational status	Literate	39	78	0.19
	Illiterate	11	22	
Employment status	Empolyed	36	72	0.10
	Unemployed	14	28	
Socio-economic status	Lower	19	38	0.012
	Lower-middle	23	66	
	Upper-middle	7	14	
	Upper	1	2	
Lifestyle	Healthy diet	20	40	0.06
	Exercise diet	9	18	
	Healthy diet+Exercise	15	30	
	None	6	12	
Alcohol consumption	Yes	18	36	0.02
	No	32	64	
Cigaratte smoking	Yes	10	20	0.17
	No	40	80	
No.of comorbidity	None	22	44	0.22
	one	17	34	
	Two	11	22	
Duration of diabetes	≤ 5	8	16	0.92
	6-10	30	60	
	11-20	12	24	
No.of diabetes complication	None	26	52	0.76
	one	21	42	
	Two	3	6	
DM control status	Uncontrolled	20	40	0.20
	Controlled	30	60	
No.of prescribed medication	≤ 2	21	42	0.05
	>2	29	58	
Medication dosage form	Injection	5	10	0.16
	Tablet	18	36	
	Both Injection and tablet	21	42	
	Other	6	12	
Monthly cost of medication	<5000rs	24	48	0.03





**Helen and Srinivasan**

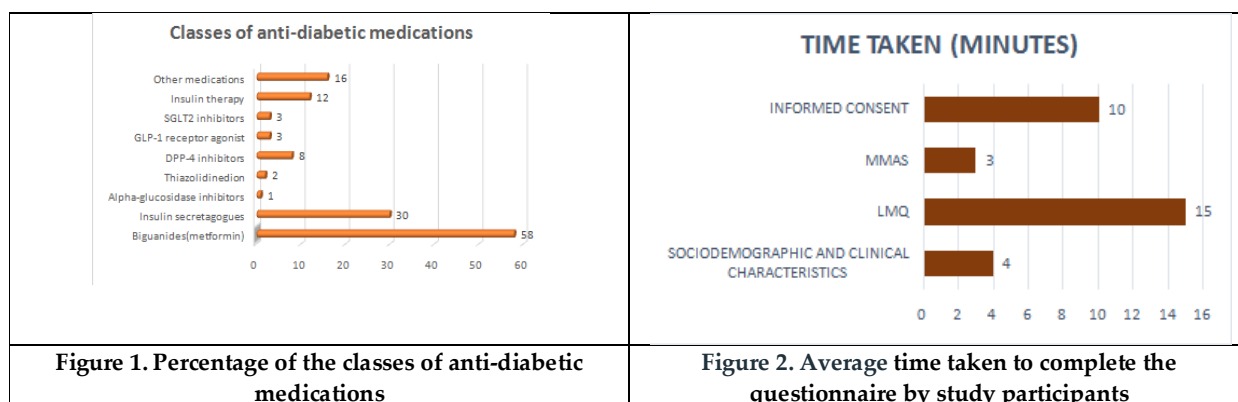
	>5000rs	26	52	
Paying for prescription	Yes	25	50	0.001
	No	25	50	

**Table 2. MRCI score among study participants**

Table 2. MRCI score among study participants MRCI SCORE	UNADJUSTED OR (95% CI)	ADJUSTED OR (95% CI)	P Value	R <sup>2</sup>
<b>Patient level</b>				
Medication count	0.92(0.87,0.96)	0.88(0.82,0.94)	<0.001	0.0862
MRCI Score	0.91(0.89,0.92)	0.89(0.87,0.92)	<0.001	0.1126
<b>Diabetes specific</b>				
Medication count	0.54(0.48,0.61)	0.59(0.52,0.66)	<0.001	0.1003
MRCI Score	0.68(0.66,0.71)	0.70(0.67,0.74)	<0.001	0.1900

**Table 3. LMQ and Adherence score**

VARIABLE	RANGE	FREQUENCY	(95% CI)	MEAN(SD)	MEDIAN(IQR)
LMQ OVERALL SCORE	41-205	-	-	124.3(15.365)	120(20)
MINIMAL BURDEN	74-106	11	12.7-10.8	-	-
MODERATE BURDEN	107-139	17	51.9-64.3	-	-
HIGH BURDEN	104-172	22	20.2-31.2	-	-
MMAS Score	-	50	11.26-23.25	2.16	2.287





## Analytical Solution of a Model of Tumor-Immune Interaction with Immune Checkpoint Inhibitor through Homotopy Perturbation Method

K.P.V.Preethi<sup>1</sup>, S.Pavithra<sup>2\*</sup> and R.Vanthana<sup>3</sup>

<sup>1</sup>Assistant Professor, Department of Mathematics, Saiva Bhanu Kshatriya College, Aruppukottai, Virudhunagar (Affiliated to Madurai Kamaraj University, Madurai) Tamil Nadu, India.

<sup>2</sup>Assistant Professor, Department of Mathematics, The Standard Fireworks, Rajaratnam College for Women, Sivakasi, Virudhunagar (Affiliated to Madurai Kamaraj University, Madurai) Tamil Nadu, India.

<sup>3</sup>Research Scholar, School of Mathematics, Madurai Kamaraj University, Madurai, Tamil Nadu, India.

Received: 22 Jan 2024

Revised: 09 Feb 2024

Accepted: 27 Apr 2024

### \*Address for Correspondence

**S.Pavithra**

Assistant Professor,  
Department of Mathematics,  
The Standard Fireworks, Rajaratnam College for Women,  
Sivakasi, Virudhunagar  
(Affiliated to Madurai Kamaraj University, Madurai)  
Tamil Nadu, India.  
Email: pavithra-mat@sfrcollege.edu.in



This is an Open Access Journal / article distributed under the terms of the **Creative Commons Attribution License** (CC BY-NC-ND 3.0) which permits unrestricted use, distribution, and reproduction in any medium, provided the original work is properly cited. All rights reserved.

### ABSTRACT

A mathematical model relating the interactions among malignant tumor cells, immune checkpoint inhibitor of CTLA-4, anti-tumor cytokines, and CD4<sup>+</sup> T cells inspecting the significance of immune checkpoints on the degradation of tumor are presented. The non-linear time dependent ordinary differential equations are solved analytically using New Homotopy Perturbation Method. The simple and closed form analytical expressions pertaining to the population malignant tumor cells, immune checkpoint inhibitor of CTLA-4, anti-tumor cytokines, and CD4<sup>+</sup> T cells are compared with the numerical results graphically. The compatibility between the analytical and numerical results shows that HPM is highly efficient in solving tumor immune interaction models. The achieved results are plausible to the entire domain of the solution.

**Keywords:** Mathematical Modeling, Immune checkpoint, Nonlinear initial value problem, Homotopy Perturbation Method.







## INTRODUCTION

Surgery, chemotherapy, and radiation therapy are the conventional treatment methods in case of malignant tumors. The use of a person's immune system to eradicate the cancer cells has been a promising approach in fighting cancer. Immunotherapy treatments are of two modalities. Cytokines and Bacillus Calmette Guérin (BCG) vaccine are injected to stimulate one's immune system where as the other is directly stimulate the immune system to fight cancers e.g., checkpoint inhibitors, adoptive cell transfer, monoclonal antibodies, and treatment vaccines. [1] Mathematical modeling of tumor-immune interactions is considered as a significant tool due to the complications of the tumor microenvironment. [2,3,4]. But these models can be employed to enhance the treatment procedure of cancer and the eradication of tumor development [5]. The model presented by Eftimie et al., showed the critical role of CD4+ T cells [6]. Instead of deriving a model which eliminates tumors through direct interactions with cytotoxic T cells, the tumor growth was suppressed by cytokine production aided to the . Later, Anderson et al. [2] analysed a tumor model along with continuous mono-immunotherapy. They pointed out that the tumor can be eradicated when cytokines dosage moves beyond the threshold value . Quezada et al. [7] demonstrated that transferring 50,000 CD4+ T cells acted as a catalyst to induce the initial regression of melanoma tumors but still failed to remove the tumor cells even after radiation therapy. Motivated by the work of [2,3,7], Jui-Ling Yu et al [8] derived a mathematical model to analyze the interactions between tumor cells and immune system using ordinary differentiation equations. Through continuous treatments, the effectiveness of immunotherapies for the development of tumor is also explored. With the advancement of nonlinear sciences, there has been an increasing interest of researchers in finding an effective solution to the complex problems arising in science and technology. The homotopy perturbation method (HPM) introduced by He [9,10] has been a versatile tool in the hands of researchers. A series of papers by He [11-14] outlined the validation of HPM by showing its effectiveness and accuracy for solving nonlinear partial and ordinary differential equations. To the best of our consciousness, there is no analytical expression constituting the population of malignant tumor cells, immune checkpoint inhibitor of CTLA-4, anti-tumor cytokines, and CD4+ T cells. Hence this paper is an attempt to estimate the approximate analytical expression for these populations by executing the new homotopy perturbation method.

### Mathematical formulation of the problem:

Recently Jui-Ling Yu et al [8] developed the mathematical model of tumor-immune interactions with an immune checkpoint inhibitor. The biological assumptions contributing to the development of the model are as follows:

1. The tumor cells growth in the absence of an immune response is logistic.
2. The CD4+ T indirectly kills tumor cells through cytokine.
3. The cancer cells activate CD4+ T cells are managed by cytokines.
4. CD4+ T cells secrete IFN- $\gamma$
5. On the surface of the CD4+ T cells, CTLA-4 are expressed.

The state variables of the tumor-immune interactions model:

- x: Tumor cell population.
- y: CD4+ T cell population
- z: IFN- $\gamma$  concentration.
- w: CTLA-4 protein population.

The model of tumor-immune interactions with an immune checkpoint inhibitor can be represented as: [8]

$$\frac{dx}{dt} = rx \left(1 - \frac{x}{k}\right) - \frac{\delta xz}{m+x} \quad (1)$$

$$\frac{dy}{dt} = \frac{\beta xz}{(x+\eta)(1+vw)} - ay \quad (2)$$





**Preethi et al.,**

$$\frac{dz}{dt} = \frac{\alpha xy}{1+bw} - \mu z \tag{3}$$

$$\frac{dw}{dt} = cy - dw \tag{4}$$

Where  $x(t)$  represents the Tumor cell population,  $y(t)$  represents the CD4<sup>+</sup> T cell population,  $z(t)$  represents the IFN- $\gamma$  concentration, and  $w(t)$  represents the CTLA-4 protein population. The evolution of tumor cell population depends on the growth rate of tumor and the removal of tumor cells by cytokines. Let  $r$  be the growth rate of tumor and  $k$  be the loading capacity of tumor.  $\delta$  is the tumor death rate killed by anti-tumor cytokines and  $m$  is the half-saturation constant of tumor death rate. CD4<sup>+</sup>T cells are T lymphocyte cells that suppress or regulate tumor cells by releasing T cell cytokines.  $\beta$  denotes the proliferation rate of Th cells and  $a$  denotes apoptosis rate of Th cells.  $\eta$  is half-saturation constant of T cells activation rate and  $v$  is the measure of inhibition of CTLA-4 on CD4<sup>+</sup> T cells. IFN- $\gamma$  are activated by tumor cell and secreted by activated CD4<sup>+</sup> T cells at  $\alpha$ . We denote IFN- $\gamma$  production rate as  $\alpha$ . The measure of inhibition of CTLA-4 on IFN- $\gamma$  is denoted by  $b$ .  $\mu$  denotes the decay rate of tumor-suppressing cytokines. CTLA-4 protein is a member of soluble proteins that are expressed by activated T cells and undergoes a natural decay with a constant rate  $d$ . The expression rate of CTLA-4 on a single CD4<sup>+</sup> T cell is denoted by  $c$  and  $d$  denotes the decay rate of CTLA-4.

**NOMENCLATURE**

Parameter	Description
$R$	The growth rate of tumor
$K$	Loading capacity of tumor
$\delta$	Tumor death rate killed by anti-tumor cytokines
$M$	Half-saturation constant of tumor death rate
$A$	Apoptosis rate of Th cells
$\beta$	Proliferation rate of Th cells
$\eta$	Half-saturation constant of T cells activation rate
$v$	The measure of inhibition of CTLA-4 on CD4 <sup>+</sup> T cells
$\alpha$	IFN- $\gamma$ production rate
$B$	The measure of inhibition of CTLA-4 on IFN- $\gamma$
$\mu$	Decay rate of tumor-suppressing cytokines
$C$	Expression rate of CTLA-4 on a single CD4 <sup>+</sup> T cell
$D$	Decay rate of CTLA-4

**Analytic expression of tumor-immune interactions with an immune checkpoint inhibitor: New Homotopy Perturbation Method**

Modeling the natural phenomena in science and engineering often leads to nonlinear problems. The solutions for these non-linear problems are more difficult than the linear ones. Hence a substantial amount of work has been devoted to find the solution of these equations analytically. Many methods such as Adomain ADM, VIM, HPM, HAM, HASTM, finite difference method and others have been adopted by researchers to solve the nonlinear differential equations. The advantage of NHPM[] over other analytical methods is its ability to reduce the difficulty of solving such nonlinear differential equations.

**Numerical Simulation**

New homotopy perturbation method is executed to find the analytical expressions of the non-linear differential time-dependent equations (1-4) for the given initial conditions. Numerical solutions were obtained by the function pde4 in Matlab software, a function of solving the initial and boundary value problems. The Matlab program is given in the appendix below. To check the efficiency of NHPM in solving the model, our analytical results are compared with the numerical results which is illustrated in the Figures 1-11.





Preethi et al.,

**Matlab/Scilab program to find the numerical solution of the eqns. (1)-(4):**

```
function main1
options= odeset('RelTol',1e-6,'Stats','on');
Xo = [20;10;10;40];
tspan = [0,1];
tic
[t,X] = ode45(@TestFunction,tspan,Xo,options);
toc
figure
hold on
%plot(t, X(:,1),'g')
%plot(t, X(:,2),'r')
%plot(t, X(:,3),'b')
%plot(t, X(:,4),'g')
return
function [dx_dt]=TestFunction(t,x)
%p=0.104;i=3;o=0.9999;q=60;g=0.1;h=0.69951;j=0.29;f=7.2511;s=1000;u=0.001;l=5;n=0;
e=0.031;
p=0.104;i=3;o=0.9999;q=60;g=0.095;h=0.69951;j=1.29;f=7.2511;s=1000;u=0.001;l=5;n=0;
e=0.031;
dx_dt(1)=(p*x(1)*(1-x(1)/i)-(o*x(1)*x(3))/(q+x(1)));
dx_dt(2)=(((j*x(1)*x(3))/((x(1)+s)*(1+u*x(4))))-(g*x(2)));
dx_dt(3)=(((f*x(1)*x(2))/(1+(h*x(4))))-(l*x(3)));
dx_dt(4)=(n*x(2)-(e*x(4)));
dx_dt = dx_dt';
return
```

**RESULTS AND DISCUSSION**

Fig.1 presents the plot of Tumor cell population  $x(t)$ ,  $CD4^+$  T cell population  $y(t)$ ,  $IFN-\gamma$  concentration  $z(t)$  and CTLA-4 protein population  $w(t)$  against time  $t$ . Fig. 2-4 shows the plot of tumor cells population  $x(t)$  against time  $t$ . Fig. 5-7 represents the plot of  $CD4^+$  T cell population  $y(t)$  against time  $t$ . Fig. 8-9 illustrates the plot of  $IFN-\gamma$  concentration  $z(t)$  against time  $t$ . Fig. 8-9 illustrates the plot of CTLA-4 protein population  $w(t)$  against time  $t$ . From, Fig. 2, it can be inferred that there is a steady decline in the tumor cell population when the loading capacity of the tumor cell decreases. Fig. 3 represents the degradation tumor cells even when the growth rate is higher. This is due to the indirection killing of tumor cells by  $CD4^+$  T cell through cytokines. From Fig. 4, it can be identified that the tumor cell cont increases when the rate of attack by cytokines is less. Fig. 5 illustrates that the tumor cells grow exponentially when there is no influence of external agent. The parameter  $a$  denotes the programmed cell death. i.e the death of cells that occur as a normal part of an organism's growth. Fig. 6 shows that the production of  $CD4^+$  T cells increases as the proliferation rate increases. These cells play a significant role by releasing cytokines. In Fig.7, it can be inferred that even when the proliferation rate is high,  $CD4^+$  T cell decreases as suppression rate of cytokines increases. Fig. 8 and 9 depicts that blockade of CTLA-4 protein leads to a significant production of  $IFN-\gamma$ . Fig. 10 presents the natural decay of CTLA-4 protein under the influence of the constant  $d$  (decay rate). Fig. 11 shows that there is a decline in of CTLA-4 protein when expression rate of CTLA-4 on a single  $CD4^+$  T cell increases as T helpers cells are killed by the apoptosis rate  $a$ .





Preethi et al.,

## CONCLUSION

A theoretical model outlining the tumor-immune interactions with an immune checkpoint inhibitor has been analysed. New Homotopy Perturbation method is executed to solve the non linear nonlinear time – dependent differential equations. An approximate analytical expression relating to the Tumor cell population  $x(t)$ ,  $CD4^+$  T cell population  $y(t)$ , IFN- $\gamma$  concentration  $z(t)$  and CTLA-4 protein population  $w(t)$  for various values of the parameters are obtained. Graphical illustration of the analytic solution with the numerical results are also presented. The illustration shows a good agreement between the analytical and numerical solutions owing to the fact that NHPM is highly reliable in solving tumor immune models.

## REFERENCES

1. <https://www.cancer.gov/about-cancer/treatment/types/immunotherapy> .
2. L. Anderson, S.R.J Jang, J.L. Yu, Qualitative behaviour of systems of tumor  $CD4^+$ cytokine interactions with treatments, *Math. Methods Appl. Sci.* 38 (2015) 4330- 4344.
3. X. Hu , S.R.J. Jang , Dynamics of tumor- $CD4$ -cytokine-host cells interactions with treatments, *Appl. Math. Comput.* 321 (2018) 700–720 .
4. D. Kirschner , J.C. Panetta , Modeling immunotherapy of the tumor-immune interaction, *J. Math. Biol.* 37 (1998) 235–252 .
5. J.M. Chrobak , H. Herrero , A mathematical model of induced cancer-adaptive immune system competition, *J. Biol. Syst.* 19 (03) (2011) 521–532 .
6. R. Efimie , et al ., Anti-tumour Th1 and Th2 immunity in the rejection of melanoma, *J. Theor. Biol.* 265 (2010) 467–480 .
7. S.A. Quezada, T.R. Simpson, K.S. Peggs, T.Merghoub, J.Vider, X.Fan, R. Blasberg, H. Yagita, P.Muranski, P.A. Antony, N.P. Restifo, J.P. Allison, Tumor-reactive  $CD4^+$  T cells develop cytotoxic activity and eradicate large established melanoma after transfer into lymphopenic hosts, *J. Exp. Med.* 207 (3) (2010) 637-650.
8. Jui-Ling Yu, Sophia R.-J. Jang, “A mathematical modelling of tumor-immune interactions with an immune checkpoint inhibitor”, *Applied Mathematics and Computation* 362 (2019).
9. J. He, Homotopy perturbation technique, *Comput. Methods Appl. Mech. Eng.* 178 (1999) 257–262, [https://doi.org/10.1016/S0045-7825\(99\)00018-3](https://doi.org/10.1016/S0045-7825(99)00018-3).
10. J.H. He, A coupling method of a homotopy technique and a perturbation technique for non-linear problems, *Int. J. Non Linear Mech.* 35 (2000) 37–43, [https://doi.org/10.1016/S0020-7462\(98\)00085-7](https://doi.org/10.1016/S0020-7462(98)00085-7).
11. J.H.He, “Application of homotopy perturbation method to non-linear wave equations”, *Chaos Soliton Fractals*, 26, pp. 695–700, 2005a.
12. J.H. He, “A coupling method of a homotopy technique and a perturbation technique for non -linear problems”, *Internat. J. Non-linear Mech.*, 35, pp. 37–43, 2000.
13. J.H. He, “Homotopy perturbation method: A new non-linear analytical technique”, *Appl. Math.Comput.*, 135, pp.73–79, 2003.
14. J.H.He, “The Homotopy perturbation method for non-linear oscillators with discontinuities , *Appl. Math. Comput.*, 151, pp.287–292, 2004a.
15. J.H. He, “New Homotopy perturbation technique”, *Comp. Meth. Appl. Mech. Engrg.*, 178 pp. 257–262, 1999.

### Appendix A: Basic concept of the homotopy perturbation method (HPM)

To explain this method, let us consider the following function:

$$D_0(u) - f(r) = 0, \quad r \in \Omega \quad (\text{A.1})$$

with the boundary condition of

$$B_0 \left( u, \frac{\partial u}{\partial n} \right) = 0, \quad r \in \Gamma \quad (\text{A.2})$$





**Preethi et al.,**

where  $D_0$  is a general differential operator,  $B_0$  is a boundary operator,  $f(r)$  is a known analytical function on and  $\Gamma$  is the boundary of the domain  $\Omega$ . In general, the operator  $D_0$  can be divided into a linear part  $L$  and a non-linear part  $N$ . The eqn. (3.1) can therefore be written as

$$L(u) + N(u) - f(r) = 0 \tag{A.3}$$

By the New homotopy technique, we construct a New homotopy  $v(r, p): \Omega \times [0,1] \rightarrow \mathfrak{R}$  that satisfies

$$H(v, p) = (1 - p)[L(v) - L(u_0)] + p[D_0(v) - f(r)] = 0. \tag{A.4}$$

$$H(v, p) = L(v) - L(u_0) + pL(u_0) + p[N(v) - f(r)] = 0. \tag{A.5}$$

Where  $p \in [0,1]$  is an embedding parameter, and  $u_0$  is an initial approximation of eqn. (3.1) that satisfies the boundary conditions. From eqns. (3.4) and (3.5), we have

$$H(v, 0) = L(v) - L(u_0) = 0 \tag{3.6}$$

$$H(v, 1) = D_0(v) - f(r) = 0 \tag{A.7}$$

When  $p=0$ , the eqns. (3.4) and (3.5) become linear equations. When  $p=1$ , they become non-linear equations. The process of changing  $p$  from zero to unity is that of  $L(v) - L(u_0) = 0$  to

$D_0(v) - f(r) = 0$ . We first use the embedding parameter  $p$  as a “small parameter” and assume that the solutions of eqns.(3.4) and (3.5) can be written as a power series in  $p$ :

$$v = v_0 + pv_1 + p^2v_2 + \dots \tag{A.8}$$

Setting  $p=1$  results in the approximate solution of the eqn.(3.1):

$$u = \lim_{p \rightarrow 1} v = v_0 + v_1 + v_2 + \dots \tag{A.9}$$

This is the basic idea of the HPM.

**Appendix B: Solution of the non-linear initial value problem using the New Homotopy perturbation method (NHPM)**

To find the solution of equation (1-4) we construct the New Homotopy as follows

$$(1 - p) \left[ \frac{dx}{dt} - rx \right] + p \left[ \frac{dx}{dt} - rx + \frac{rx^2}{k} + \frac{\delta xz}{(m+x_i)} \right] = 0 \tag{B.1}$$

$$(1 - p) \left[ \frac{dy}{dt} + ay \right] + p \left[ \frac{dy}{dt} - \frac{\beta xz}{(x_i + \eta)(1 + vw_i)} + ay \right] = 0 \tag{B.1}$$

$$(1 - p) \left[ \frac{dz}{dt} + \mu z \right] + p \left[ \frac{dz}{dt} - \frac{\alpha xy}{(1 + bw_i)} + \mu z \right] = 0 \tag{B.2}$$

$$(1 - p) \left[ \frac{dw}{dt} + dw \right] + p \left[ \frac{dw}{dt} - cy + dw \right] = 0 \tag{B.3}$$

Supposing the approximate solutions of Eq.(2.1-2.4) have the form

$$x = x_0 + px_1 + p^2x_2 + \dots \tag{B.4}$$

$$y = y_0 + py_1 + p^2y_2 + \dots \tag{B.5}$$

$$z = z_0 + pz_1 + p^2z_2 + \dots \tag{B.6}$$

$$w = w_0 + pw_1 + p^2w_2 + \dots \tag{B.7}$$

Substituting the Eq.(3.10,3.11,3.12,3.13) respectively into Eq.(2.1-2.4)





$$(1 - p) \left[ \frac{d(x_0 + px_1 + p^2x_2 + \dots)}{dt} - r(x_0 + px_1 + p^2x_2 + \dots) \right] + p \left[ \frac{d(x_0 + px_1 + p^2x_2 + \dots)}{dt} - r(x_0 + px_1 + p^2x_2 + \dots) + \frac{r(x_0^2 + px_1^2 + \dots)}{k} + \frac{\delta(x_0 + px_1 + p^2x_2 + \dots)(z_0 + pz_1 + p^2z_2 + \dots)}{(m + x_i)} \right] = 0 \tag{B.8}$$

$$(1 - p) \left[ \frac{d(y_0 + py_1 + p^2y_2 + \dots)}{dt} + a(y_0 + py_1 + p^2y_2 + \dots) \right] + p \left[ \frac{d(y_0 + py_1 + p^2y_2 + \dots)}{dt} - \frac{\beta(x_0 + px_1 + p^2x_2 + \dots)(z_0 + pz_1 + p^2z_2 + \dots)}{(x_i + \eta)(1 + vw_i)} + a(y_0 + py_1 + p^2y_2 + \dots) \right] = 0 \tag{B.9}$$

$$(1 - p) \left[ \frac{d(z_0 + pz_1 + p^2z_2 + \dots)}{dt} + \mu(z_0 + pz_1 + p^2z_2 + \dots) \right] + p \left[ \frac{d(z_0 + pz_1 + p^2z_2 + \dots)}{dt} - \frac{\alpha(x_0 + px_1 + p^2x_2 + \dots)(y_0 + py_1 + p^2y_2 + \dots)}{(1 + bw_i)} + \mu(z_0 + pz_1 + p^2z_2 + \dots) \right] = 0 \tag{B.10}$$

$$(1 - p) \left[ \frac{d(w_0 + pw_1 + p^2w_2 + \dots)}{dt} + d(w_0 + pw_1 + p^2w_2 + \dots) \right] + p \left[ \frac{d(w_0 + pw_1 + p^2w_2 + \dots)}{dt} - c(y_0 + py_1 + p^2y_2 + \dots) + d(w_0 + pw_1 + p^2w_2 + \dots) \right] = 0 \tag{B.11}$$

Equating the terms of Eq. (3.18,3.19,3.20,3.21) with the identical powers of p, we obtain

$$p^0: \frac{dx_0}{dt} - rx_0 \tag{B.22}$$

$$p^0: \frac{dy_0}{dt} + ay_0 \tag{B.23}$$

$$p^0: \frac{dz_0}{dt} + \mu z_0 \tag{B.24}$$

$$p^0: \frac{dw_0}{dt} + dw_0 \tag{B.25}$$

$$p^1: \frac{dx_1}{dt} - rx_1 + \frac{rx_0^2}{k} + \frac{\delta x_0 z_0}{(m + x_i)} = 0 \tag{B.26}$$

$$p^1: \frac{dy_1}{dt} + ay_1 - \frac{\beta x_0 z_0}{(x_i + \eta)(1 + vw_i)} = 0 \tag{B.27}$$

$$p^1: \frac{dz_1}{dt} + \mu z_1 - \frac{\alpha x_0 y_0}{(1 + bw_i)} = 0 \tag{B.28}$$

$$p^1: \frac{dw_1}{dt} + dw_1 - cy_0 = 0 \tag{B.29}$$

Tumor cell populations are given by

$$x(t) = x_i e^{rt} - \frac{rx_i^2 e^{2rt}}{kr} - \frac{\delta x_i z_i e^{(r-\mu)t}}{(m + x_i)(-\mu)} + \frac{rx_i^2 e^{rt}}{kr} + \frac{\delta x_i z_i e^{rt}}{(m + x_i)(-\mu)}$$

CD4<sup>+</sup> T cell populations are given by

$$y(t) = y_i e^{-at} + \frac{\beta x_i z_i e^{(r-\mu)t}}{(x_i + \eta)(1 + vw_i)(r - \mu + a)} - \frac{\beta x_i z_i e^{-at}}{(x_i + \eta)(1 + vw_i)(r - \mu + a)}$$

IFN- $\gamma$  concentrations are given by

$$z(t) = z_i e^{-\mu t} + \frac{\alpha x_i y_i e^{(r-a)t}}{(1 + bw_i)(r - a + \mu)} - \frac{\alpha x_i y_i e^{(-\mu)t}}{(1 + bw_i)(r - a + \mu)}$$

CTLA-4 protein populations are given by

$$w(t) = w_i e^{-dt} + \frac{cy_i e^{-at}}{(d - a)} - \frac{cy_i e^{-dt}}{(d - a)}$$



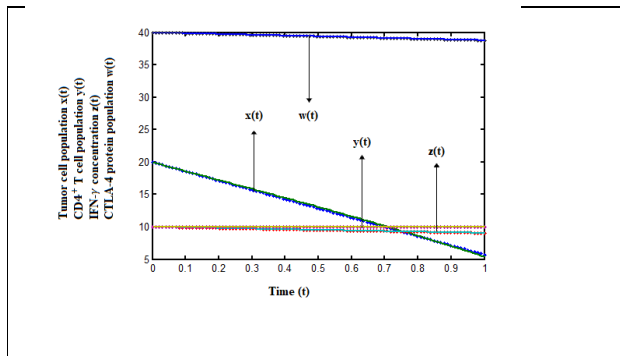


Figure 1: Illustration of analytical and numerical solutions for tumor cell population  $x(t)$  against time for Eq.(1-4) with the fixed values of the parameters  $r=0.104, k=3, \delta = 0.9999, \mu = 5, m=60$ .

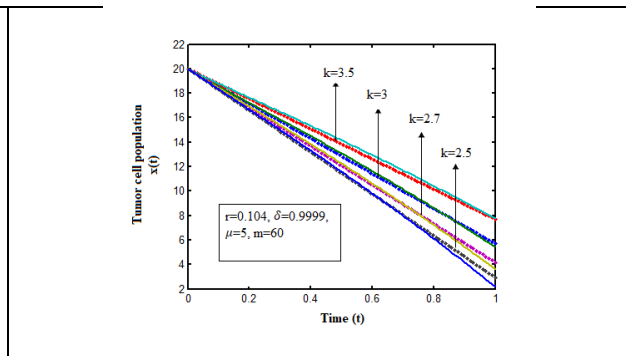


Figure 2: Illustration of analytical and numerical solutions of tumor cell population  $x(t)$  against time  $t$  for Eq.(1) with the fixed values of the parameters  $r=0.104, \delta = 0.9999, \mu = 5, m=60$  and varying  $k$ .

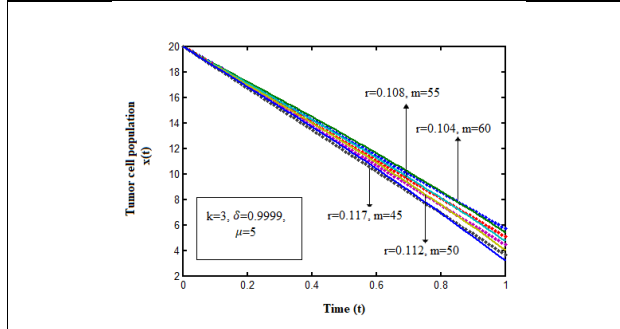


Figure 3: Illustration of analytical and numerical solutions of tumor cell population  $x(t)$  against time  $t$  for Eq.(1) with the fixed values of the  $k=3, \delta = 0.9999, \mu = 5$  and varying  $r$  and  $m$ .

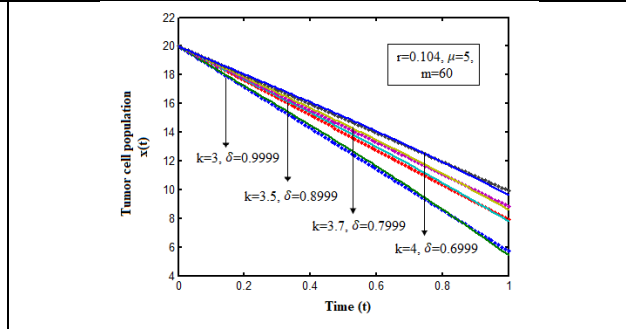


Figure 4: Illustration of analytical and numerical solutions of tumor cell population  $x(t)$  against time  $t$  for Eq.(1) with the fixed values of the  $r=0.104, \mu = 5, m=60$  and varying  $k$  and  $\delta$ .

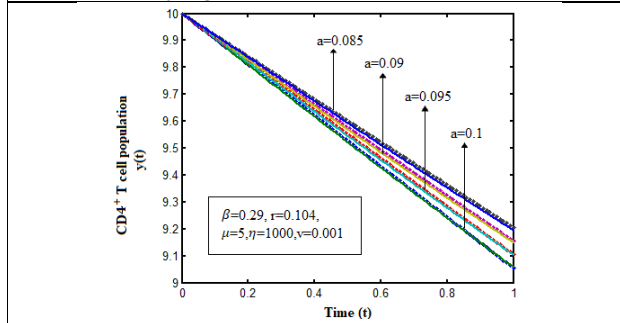


Figure 5: Illustration of analytical and numerical solutions of  $CD4^+$ T cell population  $y(t)$  against time  $t$  for Eq.(2) with the fixed values of the  $\beta = 0.29, r=0.104, \mu = 5, \eta = 1000, v=0.001$  and varying  $a$ .

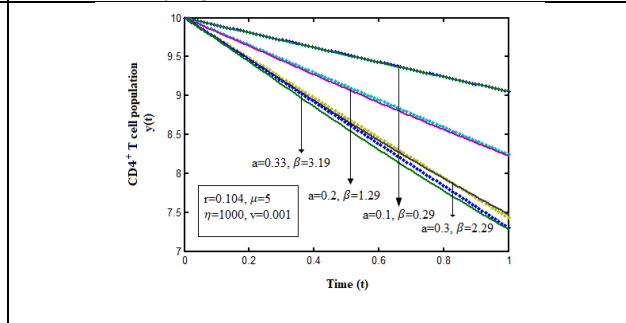


Figure 6: Illustration of analytical and numerical solutions of  $CD4^+$ T cell population  $y(t)$  against time  $t$  for Eq.(2) with the fixed values of the  $r=0.104, \mu = 5, \eta = 1000, v=0.001$  and varying  $a$  and  $\beta$ .





Preethi et al.,

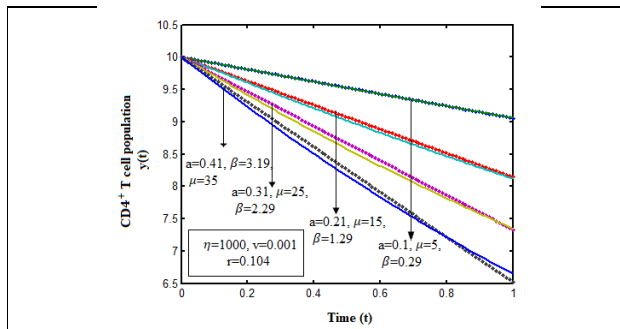


Figure 7: Illustration of analytical and numerical solutions of CD4<sup>+</sup>T cell population  $y(t)$  against time  $t$  for Eq.(2) with the fixed values of the  $r=0.104$ ,  $\eta = 1000$ ,  $v=0.001$  and varying  $a$ ,  $\mu$  and  $\beta$ .

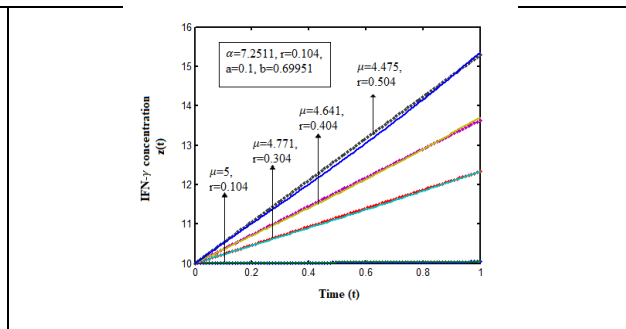


Figure 8: Illustration of analytical and numerical solutions of IFN- $\gamma$  concentration  $z(t)$  against time  $t$  for Eq.(3) with the fixed values of  $\alpha = 7.2511$ ,  $r=0.104$ ,  $a=0.1$ ,  $b=0.69951$ . and varying  $\mu$  and  $r$ .

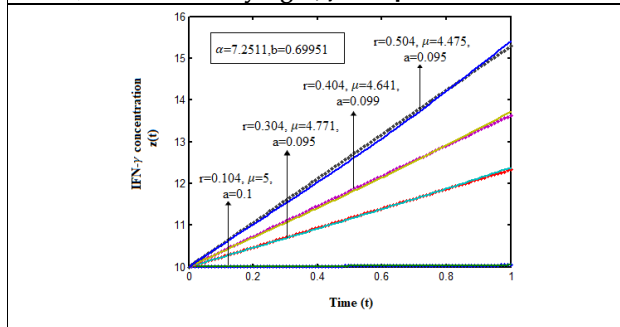


Figure 9: Illustration of analytical and numerical solutions of IFN- $\gamma$  concentration  $z(t)$  against time  $t$  for Eq.(3) with the fixed values of  $\alpha = 7.2511$ ,  $b=0.69951$  and varying  $\mu$ ,  $a$  and  $r$ .

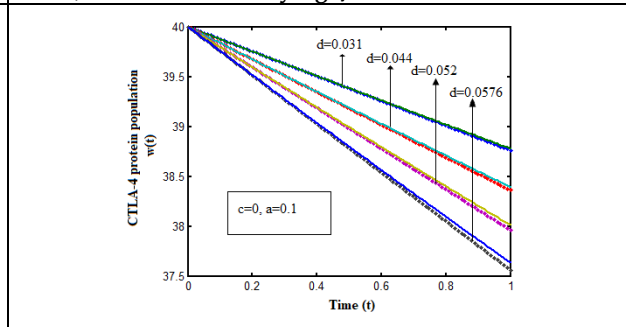


Figure 10: Illustration of analytical and numerical solutions of CTLA-4 protein population  $w(t)$  against time  $t$  for Eq.(4) with the fixed values of  $c=0.1$ ,  $a=0.1$  and varying  $d$ .

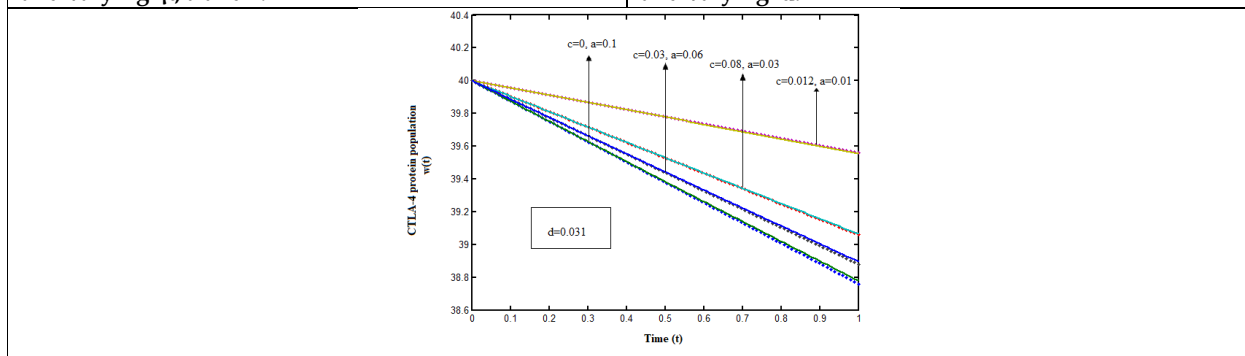


Figure 11: Illustration of analytical and numerical solutions of CTLA-4 protein population  $w(t)$  against time  $t$  for Eq.(4) with the fixed values of  $d=0.031$  and varying  $c$  and  $a$ .







## Empirical Study on Privileged Access Management and its Related Challenges in Industrial Scenario

K.R.Sumathi<sup>1\*</sup> and A.Aruljothi<sup>2</sup>

<sup>1</sup>Research Scholar, Department of Computer Science, Gobi Arts & Science College, Gobichettipalayam, (Affiliated to Bharathiar University) Coimbatore, Tamil Nadu, India.

<sup>2</sup>Associate Professor, Department of Computer Science, Gobi Arts & Science College, Gobichettipalayam, (Affiliated to Bharathiar University) Coimbatore, Tamil Nadu, India.

Received: 22 Jan 2024

Revised: 10 Apr 2024

Accepted: 10 May 2024

### \*Address for Correspondence

**K.R.Sumathi**

Research Scholar,  
Department of Computer Science,  
Gobi Arts & Science College, Gobichettipalayam,  
(Affiliated to Bharathiar University)  
Coimbatore, Tamil Nadu, India.



This is an Open Access Journal / article distributed under the terms of the **Creative Commons Attribution License** (CC BY-NC-ND 3.0) which permits unrestricted use, distribution, and reproduction in any medium, provided the original work is properly cited. All rights reserved.

### ABSTRACT

Every accomplishment intentional to preserve the client's network's usability and information or data integrity is painstaking a structure of network or connected systems security. Combination of different hardware's and multiple software technologies are incorporated. It goes subsequent to numerous threats. It thwarts intruders from receiving on the client's set of connections or from disseminating there. When businesses association their computers, specially designed systems and systems, issues with one customer may have a collision on the complete network. In spite of the numerous compensation of via networks, networking concepts increase the risk of safety measures tribulations like data or information loss, protection holes, and detrimental assaults which includes different kind of viruses and anonymous hackers. The client can obtain steps to diminish the jeopardy of unlawful admittance or destruction to their set of connections. It may not be practicable or cost-effective to entirely exterminate the entire risks, consequently doing an IT jeopardy evaluation is critical when considering what kind of steps to take. The cyber security part introduced the more than many strategies to maintain and safeguard the users from the attackers and their attacking methods by using different measures. The cyber security procedures and expertise are also known as Privileged Access Management, are used to implement be in charge of over prominent ("privileged") admittance and authorizations for clients, accounts, progressions, and systems right through an Information Technology atmosphere. Privileged Access Management supports organizations in plummeting their organization's assault surface and avoiding, or at the extremely slightest mitigating, the damage rooted by external attacks as well as internal negligence or delinquency.



**Sumathi and Aruljothi**

The possibility of implementing the Privileged Access Management and the impact of the Privileged Access Management in current world scenario is like a bird view for the user related threats. This paper deals with the Privileged Access Management adopting possibilities and its related challenges.

**Keywords:** Network Security, Cyber Security, Privileged Access Management, Risk Assessment, Information Technology Environment.

## INTRODUCTION

The COVID-19 epidemic outbreaks have inevitably increased the use of digitalized equipments nationwide while requiring territory lockdowns due to socioeconomic distance restrictions. Now, people and organisations must adjust to a new-fangled method of functioning and livelihood. Industries and most of the educational organizations are migrating to exertion online as a result of increased digitalization. Identity management and governance will be important. With the swift expansion of digital, workplace tracking and the issue of techno-stress will spread like wildfire [1]. Information technology (IT) is clearly improving an organization's capability to contend in the 21 st century's fiercely aggressive worldwide economy. However, effective and suitable IT governance is essential to the practical application of information technology. Businesses and educational institutions are shifting to working online as the world gets increasing digitally. Governance and control of identities are becoming more and more crucial. In result, efficient and suitable IT governance has a significant impact on how information technology is actually used [2].

The concept put out in this study is centered on controlling users privileged access when they are underneath the authority of a scheme or association. Given that safety measures are every organization's top priority, the echelon of safety measures features offered by the admittance managing system ought to be carefully planned in addition to configured in accordance with the time constraints [3]. Prior authors have focused mostly on risk analysis and the examination of information security components [4, 5]. This study spotlight on controlling the advantaged admittance via Active Directory Services (ADS) to offer any organization a reliable and enhanced method of managing identities. User security and privacy are frequently threatened by the stream of communications within and outer surface the company [6]. It is crucial to limit adversary assault and create a system that is capable of employ a structure and appropriate admittance between the authoritative clients [7]. Through the inclusion of the Identity Access Management (IAM) framework with Privileged Access Management (PAM), such as Active Directory, this document is optimized as a result of these technological advancements. To guarantee protected and acquiescent admittance to Information Technology resources, it is one of the main problems for organisations today is a extremely centralized Identity and Access Management (IAM) [8]. The efficient use of current compliance requirements is one of the main forces behind the integration of IAM services, infrastructures, and processes. Government administrations and organizations are increasingly and progressively establishing conformity necessities that be capable of only be regulated by standardized IAM measures, technologies and its related policies, when before merely a minute set of enforcement criterion and regulations desirable to exist adhered to.

Even while initially only relevant skill traits were important, the advantages of practice hastening throughout triumphant IAM projects are furthermore playing a progressively more significant responsibility for contemporary organisations. IAM tools may already successfully automate a large portion of client administration for endeavor applications, offering focused security analytics although facilitating cloud integration and government services. Role-based Access Control (RBAC) makes up the majority of the underlying access control model. By merging employee permissions and roles, RBAC boosts efficiency. Figure 01 explains Attribute Based Access Control (ABAC) Model. The ABAC is substantially more adaptable than RBAC and supports mapping and also coarse-grained admittance controls. Attribute Based Access Control checks the merits of people, things, or ecological factors against well-written regulations and approves or rejects admittance based on how those rules are put into practice.



**Sumathi and Aruljothi**

The figure two illustrates the Integrated Assessment Models (IAM). Compared to static jobs, IAM activities like hiring, firing, and moving people are simpler to subject to attribute-based policies. The range and reliability of these policies' intrinsic attribute values are critical components of ABAC models. As a result, organisations utilizing ABAC require a standardized method for preserving attribute data quality.

**REVIEW OF RELATED LITERATURE**

The literature study explains the necessity of outsourcing public sector employees, identity governance, and uniqueness administration frameworks in advanced teaching institutions. In order to comprehend the scaffold, corroboration, digital renovation, domination, and uniqueness administration, it strives to comprehend the key concerns and summaries the key idea of current challenges. Social media has developed into another potent platform because it is a major source of specific information. Consumers, businesses, and governments are losing billions of dollars as a result of identity fraud, as mentioned in. In, it is discussed how identity management affects socioeconomic inclusion. The authors also put up a theoretical foundation for digital identification.

While a charlatan utilizes a victim related identity or further confidential data or information stolen from a bank credit card and other or its related claims, criminals concentrate on new unethical enterprise. The formal usage and organization of a single uniqueness across every appliance domains is made possible by Identity and Access Management (IAM), which also provides security. Identity administration is vital to the security of cloud or online computing. The key issues with obtainable identity administration solutions, predominantly in communal cloud related environments, are data safety and compatibility. management affects socioeconomic inclusion. The authors also put up a theoretical foundation for digital identification.

While a charlatan utilizes a victim related identity or further confidential data or information stolen from a bank credit card and other or its related claims, criminals concentrate on new unethical enterprise. The formal usage and organization of a single uniqueness across every appliance domains is made possible by Identity and Access Management (IAM), which also provides security. Identity administration is vital to the security of cloud or online computing. The key issues with obtainable identity administration solutions, predominantly in communal cloud related environments, are data safety and compatibility.

Identity and access management solutions offer protected secret code and digital credential supervision, thereby reducing cloud-based hazards. IAM practices, IAM policies and how they are implemented and overarching access control models have all been the subject of numerous researches in recent years. For instance, RBAC is now used by hundreds of organisations as a stand-alone standard for managing information access. Based on this idea, authorizations are organized addicted to situations that are ultimately allocated to personnel. As a result, there is less need for bureaucratic overhead and a gradual rise in the number of jobs, which leaves little room for adaptation to changing circumstances.

**Existing Methodologies**

Mansour. et. al. This research methodology suggests a combined strategy that includes PAM progress as a limiting admittance organize mechanism for an Active Directory and IAM as an authentication tool. By using this technique, the government and corporate organizations' secure access policies are expanded so that they may monitor all activities and keep track of any attacks from enemies on the suggested system. The suggested approach may be a crucial means to safeguard sensitive commercial or government information against unlawful or adversarial attacks, which is for eternity demanding in several top association [9].

Eloff. et. al Information security implementation is a difficult, expensive, and time-consuming procedure. Information security is a multidisciplinary term that cuts across an, according to codes of practice for information security management. Information or data related infrastructures which are significantly fewer safe, with far extra



**Sumathi and Aruljothi**

recurrent and damaging safety measures breaches, may emerge from failing to handle all areas of information security in a well-structured and comprehensive manner. The idea of information security architecture was developed by information security professionals in response to the need for a comprehensive strategy for implementing information security. The issue is that there is currently no standardized, all-inclusive information security architecture. This research discussion provides a current overview of various distinct techniques that are all aimed at defining information security architecture [10].

Veiga. et. al. An organization's information security culture emerges as a result of specific organisational actions. Information security components are put into place by management, including technical security measures and regulations that affect how personnel interact with one another and how they conduct their jobs. Employees display various behaviors and form certain perceptions. Password sharing or reporting security incidents are two examples of actions that could help or endanger the security of information assets. The associations have to successfully govern information or data security by putting the entire indispensable information and data security components into position in regulate to instill a satisfactory intensity of information and data security society. A new complete information and data security supremacy agenda is created using the components of information security. Organisations can use the suggested governance structure to guarantee that they are overseeing information security from a comprehensive viewpoint, limiting jeopardy and fostering a tolerable degree of information and data security society [11].

Tudor. et. al. Tudor (2000) suggests a thorough and adaptable Information and Data Security Architecture strategy to safeguard an association's resources from dangers. To appraise and put controls in place to reduce such dangers, this approach emphasizes five essential principles, which are stated and are utilized to comprehend the hazard atmosphere in which organizations function. In regulate to guarantee that each association's secret data and information are protected appropriately, a focus on national rules is also made. The principles cover both process and technological aspects of meeting the security requirements of organisations [12].

**ISO/IEC**

The BS (British Standard) 7799, which was first released in three parts in 1995, is the source of ISO 27000. Information security best practises from the first section of BS 7799 were merged into ISO 17799 and added to the ISO 27000 series in 2000. The security procedures required to protect client data appropriately are described in ISO 27000. These principles are met in the actual world by ISO 27001. Businesses carry out the necessities distincted in ISO 27000 standards and utilize an ISO 27001 inspection to substantiate the competence of their ISMS. The Worldwide Organisation for Standardization (ISO) and also the International Electro technical Commission (IEC) jointly distribute the ISO/IEC 27000-series of information and data security standards, sometimes referred to as the "ISMS Family of Standards " or simply "ISO27K" [13].

**RESULTS AND DISCUSSIONS**

To specify every client's admittance controls for safety measures and protected, translucent tracking adjacent to the targeted adversarial assaults in the association, the purpose to optimise a crossbreed method, like an active directory, is very necessary. Organisations still require Active Directory to coalesce IAM with PAM in order to shield their susceptible data, despite the evolving cyber security risks. To avoid the erratic and perplexing behaviors employees engage in while accessing and reporting on their data, agencies are another reason for implementing these solutions. Using an integrated solution like Active Directory, organizations create a coordinated approach for the uniqueness of access. While PAM contains its superintendent controls with conveying the client's admittance control operation as a capability of Active Directory boundary method, IAM offers services by authenticating the specific user. The most recent approach is regimented to complete the assignment and effectively restrict admittance by the international superintendent via organisational procedures and regulations. By integrating several guidelines which that state the right system in terms of admittance to every appliance and network within the admittance apparatus with client



**Sumathi and Aruljothi**

privileges; the systems produce the desired results. This issue can be resolved, allowing organisations to consistently react to events and assist acquiescence through an incorporated execution of Identity and Access Management with Privileged Access Management. This be able to automate real-world use cases when managing privileged accounts is necessary. Table 01 shows how effective the suggested work is in comparison to the current information security components. The positive and negative percentages between the exiting methods were illustrated in Figure 03 and Figure 04.

**CONCLUSION**

In this study, every admittance administration factors recommended by various investigators in the precedent have been compared and identified. The suggested system integrates privileged access management and Active Directory collaboration. It is possible to realize that the framework methodologies discussed in this research article is additional constant and protected to grant effective admittance supervision for advantaged clients by comparing it to the earlier frameworks. The method mentioned in this context is examined for validity and security criteria. When compared to the outcomes of several access management security frameworks that have been used in the past, the suggested latest framework offers 86% more security. The framework offers greater competencies and advances than those implemented devoid of Active Directory because it is executed for a general information centre atmosphere utilizing Active Directory. The introduction of technology improvement throughout the world places a focus on intelligent control measures inside the organization that are well-organized and both business- and government-oriented. The suggested approach by one of the existing methodologies may be a crucial means to safeguard sensitive commercial or government information against illegal or adversarial assaults, which is for eternity challenging in several pinnacle associations. This study is merely an effort to develop a more digitalized cyber security system that is able to be applied to civic community and commercial organisations to build a convicted ecosystem for every association.

**REFERENCES**

1. A. Sharma, S. B. Borah and A. C. Moses, "Responses to COVID-19: The role of governance, healthcare infrastructure, and learning from past pandemics", *Journal of Business Research*, vol.122, no.06, 2021, 597–607.
2. N. Pandey and A. Pal, "Impact of digital surge during COVID-19 pandemic: A viewpoint on research and practice", *International Journal of Information Management*, vol.55, no.01, 2020, 01–05.
3. Y. Cao, Z. Huang, Y. Yu, C. Ke and Z. Wang, "A topology and risk-aware access control framework for cyber physical space", *Frontiers of Computer Science*, vol.14, no.04, 2020, 01–16.
4. Y. Maleh, M. Zaydi, A. Sahid and A. Ezzati, "Building a maturity framework for information security governance through an empirical study in organizations", *Research Anthology on Artificial Intelligence Applications in Security*, vol.01, 2021, 143–173.
5. S. AlGhamdi, K. T. Win and E. Vlahu-Gjorgievska, "Information security governance challenges and critical success factors: Systematic review," *Computers & Security*, vol.99, no.04, 2020, 01–39.
6. I. S. Bianchi and R. D. Sousa, "IT governance mechanisms in higher education". *Procedia: Computer Science*, vol.100, no.02, 2016, 941–946.
7. I. Indu, P. M. R. Anand and V. Bhaskar, "Identity and access management in cloud environment: Mechanisms and challenges", *Engineering Science and Technology, an International Journal*, vol.21, no.04, 2018, 574–588.
8. Reddy, C. S., Yookesh, T. L., & Kumar, E. B. (2022). A Study On Convergence Analysis Of Runge- Kutta Fehlberg Method To Solve Fuzzy Delay Differential Equations. *JOURNAL OF ALGEBRAIC STATISTICS*, 13(2), 2832-2838.
9. M. Bradford, J. B. Earp and S. Grabski, "Centralized end-to-end identity and access management and ERP systems: A multi-case analysis using the technology organization environment framework", *International Journal of Accounting Information Systems*, vol.15, no.02, 2014, 149–165, 2014.





**Sumathi and Aruljothi**

10. Mansour Hammoud Alruwies, Shailendra Mishra, Mohammed Abdul Rahman AlShehr, "Identity Governance Framework for Privileged Users", Computer Systems Science & Engineering, 2021, 01 – 11.
11. J. H. P. Eloff and M. M. Eloff, "Information security architecture," Computer Fraud & Security, vol.11, no.11, 2005, 10–16.
12. Yookesh, T. L., et al. &" Efficiency of iterative filtering method for solving Volterra fuzzy integral equations with a delay and material investigation."; Materials today: Proceedings 47 (2021): 6101-6104.
13. A. D. Veiga and J. H. Eloff, "An information security governance framework," Information Systems Management, vol.24, no.04, 2007, 361–372.
14. Tudor, J. K. "Information Security Architecture – An integrated approach to security in an organization", Boca Raton, FL: Auerbach, 2000.
15. ISO/IEC 27000-2018, [Online]. Available: <https://www.iso.org/obp/ui/#iso:std:iso-iec:27000:ed-5:v1:en>.

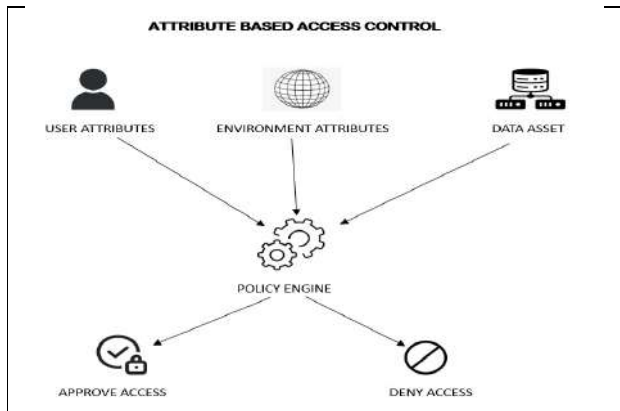
**Table.01.Comparison between different information security components**

S. No.	Information security component	Mansour. et. al	ISO/IEC	Eloff. et. al	Veiga. et. al.	Tudor. et. al
1.	Supremacy	A	NA	NA	NA	NA
2.	Safety Measures Strategy	A	A	NA	A	NA
3.	Management	A	A	A	A	A
4.	Security Association	A	A	A	A	A
5.	Strategy, Principles, and Rule	A	A	A	A	A
6.	Dimension Metrics &ROI	A	NA	A	A	NA
7.	Conformity and Observing	A	A	A	A	A
8.	Client Administration	A	A	NA	A	NA
9.	Instruction & Consciousness	A	A	NA	A	A
10.	Morals	A	A	A	NA	NA
11.	Isolation	A	A	NA	A	NA
12.	Conviction	A	A	NA	NA	Y
13.	Documentation	NA	NA	A	NA	NA
14.	Superlative Practice	A	A	A	A	A
15.	Asset Administration	A	A	A	NA	A
16.	Corporeal and Ecological Security	NA	A	A	A	A
17.	Practical Operations	A	A	A	A	A
18.	Scheme Attainment, Progress and Preservation Plan	A	A	A	A	NA
19.	Occurrence Managing Plan	A	A	NA	A	NA
20.	Industry Permanence Plan	A	A	NA	A	A
21.	Tragedy Revival Plan	A	NA	NA	A	A
22.	Hazard Appraisal Procedure and Plan	A	A	A	A	A
Number of components with A (Available) (%Converted into out of 10)		8.6%	8.1%	6.4%	7.2%	5.9%
Number of components with NA (Not Available) (%Converted into out of 10)		1.4%	1.9%	3.6%	2.8%	4.1%

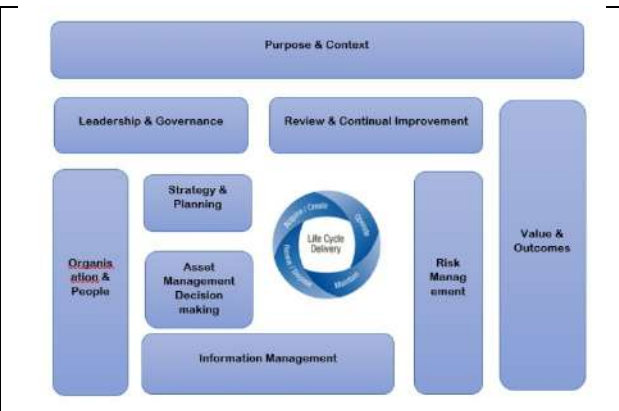




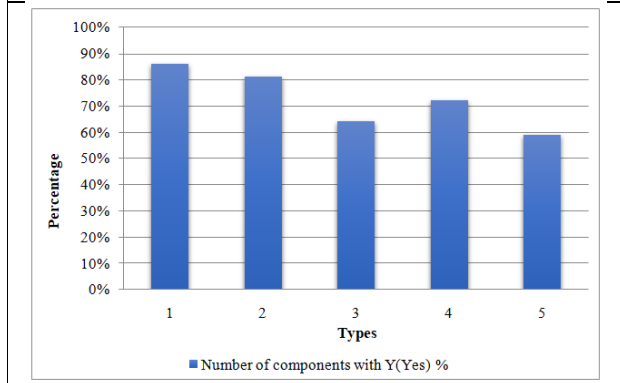
**Sumathi and Aruljothi**



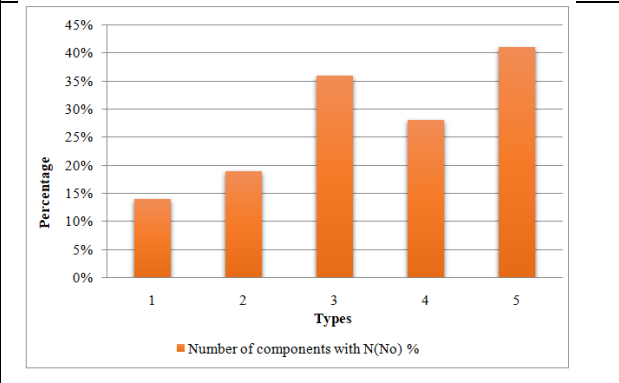
**Figure.01. Attribute Based Access Control (ABAC) Model**



**Figure.02. Integrated Assessment Models (IAM)**



**Figure.03. Comparison of different information security components with Positive percentage**



**Figure.04. Comparison of different information security components with Negative percentage**





## Effect of Edible Oil Coatings on Chemical and Sensory Attributes of *Citrus sinensis* cv. Malta under Ambient and Refrigerated Conditions

Manju Danu<sup>1\*</sup>, Suneeta Singh<sup>2</sup> and Anil Kumar Saxena<sup>3</sup>

<sup>1</sup>Student, Department of Horticulture, School of Agriculture Sciences, Shri Guru Ram Rai University, Uttarakhand, India.

<sup>2</sup>Associate Professor and Head, Department of Horticulture, School of Agriculture Sciences, Shri Guru Ram Rai University, Uttarakhand, India.

<sup>3</sup>Associate Professor, Department of Soil Science, School of Agricultural Sciences, Shri Guru Ram Rai University, Uttarakhand, India.

Received: 28 Jan 2024

Revised: 09 Feb 2024

Accepted: 26 Apr 2024

### \*Address for Correspondence

**Manju Danu**

Student,

Department of Horticulture,

School of Agriculture Sciences,

Shri Guru Ram Rai University,

Uttarakhand, India.

Email: mdanu156@gmail.com



This is an Open Access Journal / article distributed under the terms of the **Creative Commons Attribution License** (CC BY-NC-ND 3.0) which permits unrestricted use, distribution, and reproduction in any medium, provided the original work is properly cited. All rights reserved.

### ABSTRACT

An experiment was carried to assess the influence of various edible oil coatings on chemical and sensory quality of malta after 0,7,14 and 21 days of storage under ambient and refrigerated conditions. The experiment was conducted at Postharvest Technology laboratory of Department of Horticulture, School of Agricultural Sciences, Shri Guru Ram Rai University, Pathri Bagh, Dehradun, Uttarakhand during the year 2022-2023. The experiment consists of three replication and eleven treatments of different edible oil coatings. Results revealed that among various edible oil coatings, coconut oil coating (3%) under refrigerated temperature (T8) found to be the most suitable edible oil coating material for malta fruits in terms of chemical properties such as Total soluble solids (13.09 °Brix), TSS: Acid ratio (62.33), Fruit juice (48.0 ml), Juice (65.71%) as well as sensory attributes viz. Fruit Color (8.05), Fruit Taste (8.25), Fruit texture(8.25), Fruit Flavour(7.94) and Overall acceptability (7.96). Whereas, treatment T2 i.e. (Mustard oil coating @3% under ambient temperature) was found to be the most effective edible oil coating in terms of pH(3.82). However, treatment T10 (Almond oil coating @3% under refrigerated temperature) was recorded maximum titratable acidity (0.28%). Therefore, it can be concluded that edible coconut oil coating can be used to extend the chemical and sensory parameters of Malta.







Manju Danu et al.,

**Keywords:** Edible oil coating, Total soluble solids, titratable acidity Colour, Taste, Texture, Overall acceptability

## INTRODUCTION

Malta, a variety of sweet orange, scientifically known as *Citrus sinensis* (L.) Osbeck, is a significant seasonal citrus fruit popular in hills of Uttarakhand, India. The fruit is nutritious, abundant in vitamins, and loved because of its distinctive sweet-sour flavour. This fruit tree is frequently found in a dispersed fashion in home gardens and kitchen gardens, but it was unable to establish a strong position in urban or regional markets, which decreased its appeal as a commercial fruit crop. This fruit is sold in the Indian Himalayan states of Sikkim, Jammu & Kashmir, Himachal Pradesh and Uttarakhand [1]. Scientifically about Malta From the time of planting, it takes up to 5–6 years to enter the reproductive phase and grows as a shrub. This tree produces white flowers in March to May and in November to December, the fruits are plucked. During the warm winters, it's common to observe people in Uttarakhand's mountainous districts eating slices of Malta fruit marinated with homemade salt, sugar, honey, or occasionally cream. Studies have find out that this fruit contains 47 kcal energy, 0.94g protein, 0.12g fat, 2.4g dietary fibre, 53.2 mg vitamin C, 0.1mg iron, 14 mg phosphorus and 10 mg magnesium. This fruit is also consumed and used in many forms like juice, squash, candy, jam, essential oil, peel powder etc. Every 100 g of malta squash and ready to serve (RTS) drinks contain about total soluble solids (10°Brix), 88.4 g water, 0.6 g protein, 10.5 g carbohydrates, 0.12g fibers and 0.3g ash with 0.41% acidity [2]. Edible coatings is the thin layer of material which can be consumed and provide a barrier to oxygen, microbes of external source, moisture and solute movement for food. In edible coating a semi permeable barrier is provided and is aimed to extend shelf life by decreasing moisture and solute migration, gas exchange, oxidative reaction rates and respiration as well as to reduce physiological disorders on fresh cut fruits. Edible coatings are used for extension of shelf life of fruits and vegetables.

These can also be safely eaten as part of the product and do not add unfavourable properties to the food stuff. Among various postharvest treatments, the application of edible coating like oil, wax and chemical to fruits is receiving more attention as these coatings are capable of maintaining quality even in ordinary storage conditions [3]. Edible coating of fruits blocks the pores within the fruits, reduces respiration and creates a modified atmosphere which helps to improve postharvest quality [4]. Edible coatings reduce respiration, improve textural quality, helps to retain volatile flavor, reduce microbial growth and protect from deterioration [5]. Edible coatings maintain structural integrity and protect against mechanical damages [6]. Edible coatings improve the firmness and minimize the weight loss of mandarin as compared to uncoated [7]. Prolongation of shelf life and maintenance of the quality of mandarin fruit could be obtained by using different surface coatings than without using surface coatings [8]. Edible coatings or films increase the shelf life of fruits and vegetables and are environment friendly. In recent years, new edible films and coatings have been developed with the addition of various and edible herbs, antimicrobial compounds to preserve fresh fruits and vegetables. The populations consuming diets high in coconut oil show no adverse effects on the health of the population. Coconut oil has >90% saturated fatty acids, hence is less attractive to consumers. Saturated fat is one that has no unsaturation or double bonds and tends to be solid at room temperature. Coconut oil is rich in short and medium chain fatty acids. Shorter chain length allows fatty acids to be metabolized without use of the carnitine transport system. Coconut oil contains a high proportion of glycerides of lower chain fatty acids .The oil is highly stable towards atmospheric oxidation. The oil is characterized by a low iodine value high saponification value, high saturated fatty acids content and is a liquid at room temperatures of 27°C [9]. Olive oil sensory uniqueness as well as its important nutritional properties has been the favourite of Mediterranean countries consumers and now throughout the world. Diverse varieties of olive fruits due to the variations in composition and overall properties have shown different behaviours in terms of quality loss when subjected to different temperatures.[10] **Taluri et al., (2011)** Mustard oil can mean either the pressed oil used for pungent essential oil also known as volatile oil of mustard. The essential oil results from grinding mustard seed, mixing the grounds with





Manju Danu *et al.*,

water, and isolating the resulting volatile oil by distillation. It can also be produced by dry distillation of the seed. Walnuts contain kernels that have high content of glyceride oil. It varies widely (52-75%), depending on the variety, cultivation, place of growing and irrigation of walnut trees. Regarding the fatty acid composition unsaturated fatty acids are dominating oleic, linoleic and linolenic. Ratio of these acids determines the nutritional value of walnut oil. Monounsaturated fatty acids have a beneficial effect on human health [11]. Almonds from the Rosaceae family, have long been known as a source of essential nutrients; nowadays, they are in demand as a healthy food with increasing popularity for the general population and producers. Studies on the composition and characterization of almond macro- and micronutrients have shown that the nut has many nutritious ingredients such as fatty acids, lipids, amino acids, proteins, carbohydrates, vitamins and minerals, as well as secondary metabolites. Now a day's various chemicals are used to enhance the shelf life of fruits which is harmful for human health. However, some edible oil coating substances have enhanced their shelf life, reduce the spoilage and improved the fruit quality by delaying the senescence during storage. Therefore, the present study was done to find out the effect of various edible oil coating materials on chemical and sensory qualities of malta during storage.

## MATERIALS AND METHODS

### Experimental site

The experiment was performed from 1<sup>st</sup> December 2022 to 21<sup>st</sup> December 2022 in the Postharvest Technology laboratory of Department of Horticulture, School of Agricultural Sciences, Shri Guru Ram Rai University, Pathri Bagh, Dehradun, Uttarakhand, India. Geographically, the experimental site is located in between 29°58' and 31°2'30" North latitude and 77° 34'45" and 78°18'30" East longitudes.

### Experimental details and materials

The experiment was laid out in Completely Randomized Design (CRD) with three replications having eleven treatments in each replication. The malta fruits were collected from a local orchard of Dhar Payankoti village, District Tehri Garhwal, Uttarakhand (India). The fruits were harvested at a mature stage. Malta fruits were sorted out to eliminate bruised, damaged, misshaped and punctured ones. Selected fruits having good quality were individually coated with prepared concentration of different edible coating materials according to treatments with the help of cotton (Table 1). The treated fruits were allowed to dry in fresh air. Then malta were kept in the locally available tray in an open lab condition at ambient room conditions (18±2°C and 52.41±14.35% RH) and in refrigerator conditions at (5±2°C and 62.45±10.55% RH).

### Data collection

In this experiment the following parameters were studied:

#### Chemical attributes

##### Total soluble solids (°Brix)

The total soluble solids (TSS) were recorded in °Brix by using digital refractometer on the 0, 7, 14 & 21 days of storage.

##### pH

pH is the equilibrium measure of hydrogen ion concentration in a juice. It was measured with Digital pH meter. First pH meter was calibrated with the three standard buffer solution, after calibration, pH of juice was determined. The fruit juice prepared was used for pH measurement too and expressed as a unitless number.

##### Titrateable acidity (%)

The acidity was estimated as per titrimetric method [12]. A total of 10 ml of the clear juice of a fruit from each treatment was taken and titrated against standard 0.1 N of sodium hydroxide (NaOH) solution using





**Manju Danu et al.,**

phenolphthalein as an indicator. Then the titratable acidity of the fruit was expressed in percentage using the following formula:

$$\text{Acidity\%} = \frac{\text{Titre value} \times \text{Normality of alkali} \times \text{Equivalent weight of acid} \times \text{Volume made} \times 100}{\text{Volume of sample taken} \times \text{Weight of sample} \times 100}$$

#### Juice content (%)

The juice was extracted by squeezing manually. The volume of juice was measured (ml/fruit) with the help of a measuring cylinder. The average juice percentage per fruit was calculated by the following formula:

$$\text{Juice percentage} = \frac{\text{Juice Weight}}{\text{Fruit Weight}} \times 10$$

#### Juice (ml)

Juice after extraction was measured in the measuring cylinder and average was calculated in ml.

#### TSS: Acid ratio

This was done by simply dividing the amount of TSS result of every day to the Titratable acidity of the same day and data was pool for analysis.

$$\text{TSS: Acid ratio} = \frac{\text{Total soluble solids}}{\text{Titratable acidity}}$$

#### Sensory attributes

Sensory evaluation of malta was performed by 20 semi trained panelists. The 9-point hedonic scale and composite scoring tests were used to carry out sensory evaluation. They assessed malta in terms of Colour, Taste, Texture and Flavour properties. Overall acceptability score was calculated as average of the whole sensory attributes.

#### Statistical analysis

The edible oil coated fruits were evaluated by a panel of 20 semi-trained members using 9 point Hedonic scale for colour, taste, texture and overall acceptability i.e. like extremely 9, like very much 8, like moderately 7, like slightly 6, neither like nor dislike 5, dislike slightly 4, dislike moderately 3, dislike very much 2, dislike extremely 1 [13]. Statistical analysis of the data pertaining to the sensory evaluation of osmotically preserve fruits were analysed according to randomized block design [14] while, that on physico-chemical characteristics by factorial completely randomized design [15]. The values were compared at 5% level of significance.

## RESULTS AND DISCUSSION

The data were recorded at regular intervals on 0, 7, 14 and 21 days after treatment for chemical and sensory attributes of Malta.

#### Total Soluble Solids

The data recorded on Total soluble solids (TSS) at different intervals. The effect of edible oil coatings are presented in the Table 2 and Fig.1. As evident from table, during initial days observation shows the treatment differences were non-significant. After 7 days, the maximum TSS was recorded in treatment T8 (11.01°Brix) with coconut oil coating (3%) under refrigerated temperature followed by T9(9.89 °Brix) which was at par with treatments T6 (9.61 °Brix), T11 (9.49 °Brix) and T5(9.09 °Brix). The minimum TSS was recorded in T10(8.85 °Brix) with almond oil coating (3%) under refrigerated temperature. After 14 days interval, maximum TSS was recorded in treatment T8 (12.04 °Brix) with coconut oil coating (3%) under refrigerated temperature whereas minimum TSS was recorded under the treatment in T10( 9.09) with almond oil coating (3%) under refrigerated temperature. Finally after 21 Days, the TSS was recorded maximum in treatment T8 (13.09) which were at par with T4(.11.76), T3 (11.75) and T11 (11.65). However significance difference was observed with treatment in T6 (11.12), T9( 10.15) and T7(10.09).While minimum Total soluble Solids





Manju Danu et al.,

(TSS) was recorded under the treatment in T5 ( 9.50) with Almond oil coating (3%) under ambient temperature. The above findings are in line with the findings of [16].

#### pH

The observation of pH was recorded at 0, 7, 14 and 21 days interval. The effects of oil coatings on pH are presented in the Table 2 and Fig.2. As evident from table the different treatments did not show any marked variation in pH. During the whole observation shows the treatments were non- significant.

#### Titratable acidity (%)

The observation of titratable acidity was recorded at 0, 7, 14 and at 21 days interval. The effects of oil coatings on titratable acidity are presented in the Table 2. and Fig.3. As evident from table the different treatments did not show any marked variation in titratable acidity. During the whole observation shows the treatments were non- significant.

#### Fruit Juice (%)

The data recorded on fruit juice (%) at different intervals. The effect of edible oil coatings are presented in the Table 4 and Fig.4. The maximum fruit juice (%) was recorded in treatment T8 (65.71) which were at par with T5 (65.71) and T3 (64.38). While fruit juice (%) was minimum recorded under the treatment in T1 (57.69) without oil coating under ambient temperature. Fruit juice (%) was significantly affected in all days of interval with effect Coconut oil coating (3%) under refrigerated temperature. The percentage of juice content showed increase in all treatments during storage. Only coconut oil and kept in refrigerated temperature had gained gradual increment of juice content. Juice content is one of the important characters of mandarin oranges. Customers prefer those mandarin oranges which have more juice content and such mandarin oranges get high market price also. There is a decrease in the juice percentage of mandarin during the storage due to the moisture loss from the surface of fruits [15](Rokaya et al., 2016; Joshi et al., 2020). So to know the effect of different edible coatings on the juice content of the mandarin this parameter was observed. The above findings are in line with the findings of [17] in mandarin.

#### Juice (ml)

The observation of fruit juice (ml) was recorded at 0, 7, 14 and 21 days interval. The effects of oil coatings on juice in ml are presented in the Table 2 and Fig.5. As evident from table the different treatments did not show any marked variation in juice (ml). During the whole experiment, the treatments were non- significant effects of various edible oil coatings on fruit juice (ml).

#### TSS: Acid ratio

The data recorded on fruit TSS: Acid ratio are presented in the Table 3 and Fig. 6. The observation of fruit TSS : Acid ratio was recorded at 0, 7, 14 and 21 days interval. As evident from table, during initial days observation shows the treatment differences were non-significant. At 7 days maximum fruit TSS: Acid ratio was recorded in T8 (34.41) with Coconut oil coating (3%) under refrigerated temperature. The fruit TSS: Acid ratio in treatment T6 (28.26) with Walnut oil coating (3%) under ambient temperature and T7(27.33) with Mustard oil coating (3%) under refrigerated temperature were found in statistically at per whereas, minimum fruit TSS: Acid ratio was recorded in treatment T1 (29.32) Without oil coating under ambient temperature. In 14 days interval the maximum TSS: Acid ratio was recorded in treatment T8 (46.31) with Coconut oil coating (3%) under refrigerated temperature. Which was at par with treatments T11 (37.86) and T9 (36.33). The minimum TSS: Acid ratio was recorded under the Treatment in T1 (29.32) without oil coating under ambient temperature. In 21 Days, the TSS: Acid ratio was maximum in treatment T8 (62.33) which were at with T2 (52.27). However significance difference was observed with treatment in T4(49.00), T3 (48.96), and T10(42.29). While minimum TSS: Acid ratio was recorded under the treatment in T1 (36.52) without oil coating under ambient temperature. The above findings are in line with the findings of [18] in acid lime.





Manju Danu et al.,

#### **Fruit Color**

The observation of fruit color was recorded at 0, 7, 14 and 21 days interval. The data recorded on fruit color at different days of interval are presented in the Table 5. As evident from table, during initial days observation shows the treatment differences were non-significant. In 7 days interval the maximum Fruit color was recorded in treatment T8 (8.68) with Coconut oil coating (3%) under refrigerated temperature flowed by T9 (8.58). Which was at par with treatments T10(7.89) T11 (7.94), T2 (7.71) and T6 (7.34). The minimum Fruit color was recorded under the Treatment in T1 (5.54) with without oil coating under ambient temperature. In 14 days interval the maximum Fruit color was recorded in treatment T8 (7.92) with Coconut oil coating (3%) under refrigerated temperature flowed by T9(7.86). The minimum Fruit color was recorded under the Treatment in T1 (6.37) with without oil coating under ambient temperature. In 21 Days, the Fruit color was maximum in treatment T8 (8.05) which were at par with T9 (7.83) and T10 (7.77). T11 (7.38). However significance difference was observed with treatment in T7 (7.22), and T5 (7.05). While Fruit color was minimum recorded under the treatment in T1( 6.00) without oil coating under ambient temperature. Similar results were also reported by [19] in lemon.

#### **Fruit Taste**

In 7 days interval the maximum fruit taste was recorded in treatment T8 (8.73) with Coconut oil coating (3%) under refrigerated temperature flowed by T10 (8.66). Which was at par with treatments T4 (8.66) and T10 (8.04). The minimum fruit taste was recorded under the Treatment in T1 (5.77) with without oil coating under ambient temperature. In 14 days interval the maximum fruit taste was recorded in treatment T8 (8.05) with Coconut oil coating (3%) under refrigerated temperature which was equal at T10 (8.05). The minimum fruit taste was recorded under the Treatment in T1 (5.88) with without oil coating under ambient temperature. In 21 Days, the maximum fruit taste was recorded in treatment T8 (8.05) with Coconut oil coating (3%) under refrigerated temperature which was equal at T10 (8.05). The minimum fruit taste was recorded under the Treatment in T1 (5.88) with without oil coating under ambient temperature. The fruit taste was significantly affected by the Coating of Coconut oil coating (3%) under refrigerated temperature. Similar results were also reported by [20].

#### **Fruit texture**

In 7 days interval the maximum fruit texture was recorded in treatment T8 (8.37) with Coconut oil coating (3%) under refrigerated temperature flowed by T3 ( 8.14). Which was at par with treatments T5 (7.91), T7 (7.49) and T10 (7.34). The fruit texture was recorded under the Treatment in T1 (6.06) with without oil coating under ambient temperature. In 14 days and 21 Days, the maximum fruit texture was recorded in treatment T8 (8.25) with Coconut oil coating (3%) under refrigerated temperature flowed by T5( 8.05). The minimum fruit texture was recorded under the Treatment in T1( 6.5) with without oil coating under ambient temperature. The fruit texture was significantly affected by the coating of Coconut oil coating (3%) under refrigerated temperature. Similar results were also reported by [21].

#### **Fruit Flavour**

In 7 days interval the maximum fruit Flavor was recorded in treatment T8 (8.65) with Coconut oil coating (3%) under refrigerated temperature flowed by T7(8.60). Which was at par with treatments T10 (8.42) T4(7.61) and T9(7.34). The minimum fruit Flavour was recorded under the Treatment in T1 (5.82) with without oil coating under ambient temperature. In 14 days interval and 21 Days, the maximum fruit Flavour was recorded in treatment T8 (7.94) with Coconut oil coating (3%) under refrigerated temperature flowed by T9 (7.86). The minimum fruit Flavour was recorded under the Treatment in T1 (6.81) with without oil coating under ambient temperature. The fruit Flavour was significantly affected by the Coating of Coconut oil coating (3%) under refrigerated temperature. Similar results were also reported by [21].





Manju Danu et al.,

### Fruit Overall acceptability

In 7 days interval the maximum fruit Overall acceptability was recorded in treatment T8 (8.53) with Coconut oil coating (3%) under refrigerated temperature flowed by T6(8.06) and T5 (8.05). Which was at par with treatments T3 (7.99) T10 (7.79) and T11(7.32).The minimum fruit Overall acceptability was recorded under the Treatment in T1 (5.8) with without oil coating under ambient temperature. In 14 days interval and 21 Days, the maximum Overall acceptability was recorded in treatment T8 (7.9) with Coconut oil coating (3%) under refrigerated temperature flowed by T4 (7.81). The minimum fruit Overall acceptability was recorded under the Treatment in T1 (6.72) with without oil coating under ambient temperature. The Overall acceptability was significantly affected by the Coating of Coconut oil coating (3%) under refrigerated temperature. The above findings are in line with the findings of [22].

## CONCLUSION

It can be concluded that among various edible oil coatings, coconut oil coating (3%) under refrigerated temperature (T8) found to be the most efficient edible oil coating treatment in terms of Total soluble solids (°Brix), TSS: Acid ratio, Fruit juice (ml), Juice (%), Fruit color, Fruit taste, Fruit texture, Fruit flavour and Overall acceptability. Whereas, treatment T2 (Mustard oil coating @3% under ambient temperature) was found to be the most valuable edible oil coating treatment in terms of pH. However, treatment T10 (Almond oil coating @3% under refrigerated temperature) was found to be most effective in terms of Titratable Acidity (%). Therefore, it can be concluded that edible coconut oil coating can be used to retain the chemical and sensory qualities of Malta.

## REFERENCES

1. Shah NC. Citrus fruits in India- Part 1. 2014. The Scitech Journal, 1(12): 30- 36
2. Syed Amir Ashraf, University of Hail, Saudi Arabia M. Leonor Faleiro, 2022. University of Algarve, Portugal Saber Amiri, Urmia University, Iran Sajid Ali, Bahauddin Zakariya University, Pakistan Suriati L (2022) Nano Coating of Aloe-Gel Incorporation Additives to Maintain the Quality of Freshly Cut Fruits.
3. Bisen, A., Pandey, S., & Patel, N. 2012. Effect of skin coatings on prolonging shelf life of kagzi lime fruits (*Citrus aurantifolia* Swingle). Journal of Food Science and Technology, 49(6): 753–759. DOI: 10.1007/s13197-010-0214-y
4. Kader, A. 2005. Increasing food availability and reducing postharvest losses of fresh produce. Acta Horticulturae, 682: 2169–2176. DOI: 10.17660/ActaHortic.2005.682.296.
5. Mahfoudhi, N., Chouaibi, M., & Hamdi, S. 2014. Effectiveness of almond gum trees exudate as a novel edible coating for improving postharvest quality of tomato (*Solanum lycopersicum* L.) fruits. Food Science and Technology International, 20(1): 33–43. DOI: 10.1177/1082013212469617.
6. Dhall, R.K. 2013. Advances in edible coatings for fresh fruits and vegetables: A review. Critical Reviews in Food and Nutrition, 53: 435–450. DOI: 10.1080/10408398.2010.541568.
7. Navarro-Tarazaga, M.L.L., & Perez-Gago, M.B. 2006. Effect of edible coatings on quality of mandarins cv. Clemenules. Proceedings of the Florida State Horticultural Society. 119: 350–352.
8. Joshi, P., Ojha, B.R., and Kafle, A. 2020. Effect of Different Postharvest Treatments on Prolonging Shelf life of *Citrus reticulata* Blanco. Nepalese Horticulture, 14: 1–8. DOI: https://doi.org/10.3126/nh.v14i1.30603.
9. Saxena A, Singh A. 2014. Marketing of sweet orange (malta) in Uttarakhand. International Journal of Commerce and Business Management, 8(2): 290-295. Shah NC. Citrus fruits in India- Part 1.
10. Saki, M., ValizadehKaji, B., Abbasifar, A., & Shahrjerdi, I. 2019. Effect of chitosan coating combined with thymol essential oil on physicochemical and qualitative properties of fresh fig (*Ficus carica* L.) fruit during cold storage. Journal of Food Measurement and Characterization, 13(2).
11. Joshi P, Ojha B.P., & Kafle A. 2019. Effect of different postharvest treatments on prolonging shelf life and





**Manju Danu et al.,**

maintaining quality of mandarin (*Citrus reticulata* Blanco.) J. ofPharma and Phyto. Chem, SP5, 139-144.

12. S. Ranganna, "Handbook of analysis and quality control for fruit and vegetable products," 2nd edn, Tata McGraw-Hill Publication, New Delhi, 2009.
13. Amerine MA, Pangborn RM, Roessler EB. Principles of Sensory Evaluation of Food. Academic Press, London, 1965, pp. 5.
14. Mahony MO. Sensory evaluation of Food. In: Statistical methods and procedures. Marcel Dekker, Inc. New York, 1985.
15. Cochran WG, Cox GW. Experimental Designs. John Wiley & Sons, Inc., New York, 1967.
16. Singh, U.B. and Mohammed, S. 2016. Comparative efficacy of wax emulsion and rice starch on post-harvest shelf life of fully ripe guava fruits. Journal of Food Science Technology. 24(5):256-262.
17. Sharmin, M., M. Islam and M. Alim. 2016. Shelf life enhancement of papaya with aloe vera gel coating at ambient temperature. J. Ban Agril. Univ. 13(1): 131.
18. Nandane, A. S., R. K. Dave and T. V. R. Rao. 2016. Optimization of edible coating formulations for improving postharvest quality and shelf life of pear fruit using response surface methodology. J. Food Sci. and Tech. 54(1): 1–8
19. Kumar, P.; Sethi, S.; Sharma, R.R.; Srivastav, M.; Varghese, E. Effect of chitosan coating on postharvest life and quality of plum during storage at low temperature. *Sci. Hortic.* 2017, 226, 104–109.
20. Sharma, P.; Shehin, V.P.; Kaur, N.; Vyas, P. Application of edible coatings on fresh and minimally processed vegetables: A review. *Int. J. Veg. Sci.* 2019, 25, 295–314
21. Ncama, K.; Magwaza, L.S.; Mditshwa, A.; Tesfay, S.Z. Plant-based edible coatings for managing postharvest quality of fresh horticultural produce: A review. *Food Packag. Shelf Life* 2018, 16, 157–167.
22. Nawab, A.; Alam, F.; Hasnain, A. Mango kernel starch as a novel edible coating for enhancing shelf-life of tomato (*Solanum lycopersicum*) fruit. *Int. J. Biol. Macromol.* 2017, 103, 581–586.

**Table 1: Treatment combination**

Symbol	Treatment doses
T1	(Control) without oil coating + Ambient condition
T2	Mustard oil coating (3%) + Ambient condition
T3	Coconut oil coating (3%) + Ambient condition
T4	Olive oil coating (3%) + Ambient condition
T5	Almond oil coating (3%) + Ambient condition
T6	Walnut oil coating (3%) + Ambient condition
T7	Mustard oil coating (3%) + Refrigerated condition
T8	Coconut oil coating (3%) + Refrigerated condition
T9	Olive oil coating (3%) + Refrigerated condition
T10	Almond oil coating (3%) + Refrigerated condition
T11	Walnut oil coating (3%) + Refrigerated condition

**Table 2: Effect of various edible oil coatings on Total Soluble solids and pH at ambient temperature and Refrigerated temperature**

Symbol	Treatments	Total Soluble solids (°Brix)				pH			
		Days after Storage				Days after Storage			
		0	7	14	21	0	7	14	21





Manju Danu et al.,

T <sub>1</sub>	Without Oil + Ambient Temperature	8.7	9.09	9.89	10.86	2.860	3.17	3.41	3.76
T <sub>2</sub>	Mustard Oil + Ambient Temperature	8.2	8.99	9.15	11.50	2.820	3.21	3.45	3.82
T <sub>3</sub>	Coconut Oil + Ambient Temperature	8.27	8.95	9.36	11.75	2.750	3.22	3.51	3.81
T <sub>4</sub>	Olive Oil + Ambient Temperature	8.12	8.89	9.35	11.76	2.850	3.25	3.53	3.80
T <sub>5</sub>	Almond Oil + Ambient Temperature	8.09	9.09	9.24	9.50	2.890	3.21	3.51	3.76
T <sub>6</sub>	Walnut Oil + Ambient Temperature	8.02	9.61	10.02	11.12	2.930	3.18	3.52	3.81
T <sub>7</sub>	Mustard Oil + Refrigerated Temperature	8.49	9.02	9.99	10.09	2.940	3.23	3.51	3.82
T <sub>8</sub>	Coconut Oil + Refrigerated Temperature	8.69	11.01	12.04	13.09	2.830	3.2	3.45	3.78
T <sub>9</sub>	Olive Oil + Refrigerated Temperature	8.2	9.89	9.51	10.15	2.810	3.21	3.42	3.75
T <sub>10</sub>	Almond Oil + Refrigerated Temperature	7.85	8.85	9.09	9.86	2.830	3.22	3.45	3.81
T <sub>11</sub>	Walnut Oil + Refrigerated Temperature	8.67	9.49	10.60	11.65	2.910	3.18	3.41	3.78
S.Em±		0.26	0.12	0.28	0.09	0.083	0.04	0.06	0.08
C.D. @ 5%		NS	0.59	1.44	0.46	NS	NS	NS	NS

**Table 3: Effect of Various edible oil coatings on Titratable Acidity and TSS: Acid Ratio of Malta in ambient temperature and Refrigerated temperature**

Symbol	Treatments	Titratable Acidity (%)				TSS:Acid Ratio			
		Days after Storage				Days after Storage			
		0	7	14	21	0	7	14	21
T <sub>1</sub>	Without Oil + Ambient Temperature	0.41	0.377	0.27	0.217	19.15	23.29	29.72	36.52
T <sub>2</sub>	Mustard Oil + Ambient Temperature	0.40	0.363	0.28	0.227	20.00	25.69	31.55	52.27
T <sub>3</sub>	Coconut Oil + Ambient Temperature	0.43	0.370	0.28	0.247	18.80	24.86	31.20	48.96
T <sub>4</sub>	Olive Oil + Ambient Temperature	0.40	0.370	0.29	0.247	19.80	24.69	30.16	49.00
T <sub>5</sub>	Almond Oil + Ambient Temperature	0.46	0.363	0.29	0.257	17.21	25.97	29.81	38.00
T <sub>6</sub>	Walnut Oil + Ambient Temperature	0.40	0.357	0.29	0.287	19.56	28.26	31.31	39.71
T <sub>7</sub>	Mustard Oil + Refrigerated Temperature	0.39	0.350	0.29	0.237	21.23	27.33	31.22	43.87
T <sub>8</sub>	Coconut Oil + Refrigerated Temperature	0.38	0.343	0.27	0.217	22.28	34.41	46.31	62.33
T <sub>9</sub>	Olive Oil + Refrigerated Temperature	0.40	0.377	0.29	0.247	20.71	24.57	36.63	51.71
T <sub>10</sub>	Almond Oil + Refrigerated Temperature	0.40	0.383	0.29	0.277	20.00	26.73	29.72	42.29
T <sub>11</sub>	Walnut Oil + Refrigerated Temperature	0.38	0.343	0.28	0.227	22.23	29.66	37.86	52.95
S.Em±		0.02	0.018	0.01	0.013	0.58	0.50	0.59	0.72
C.D. @ 5%		NS	NS	NS	NS	NS	2.54	3.01	3.64







**Manju Danu et al.,**

**Table 4: Effect of various edible oil coatings on Juice (%) and Juice (ml) of malta fruits in ambient temperature and Refrigerated temperature**

Symbol	Treatments	Juice %				Juice (ml)			
		Days after Storage				Days after Storage			
		0	7	14	21	0	7	14	21
T <sub>1</sub>	Without Oil + Ambient Temperature	70.54	66.30	60.24	57.69	78	62	51	46.00
T <sub>2</sub>	Mustard Oil + Ambient Temperature	67.83	66.67	61.18	60.26	78	61	52	47.00
T <sub>3</sub>	Coconut Oil + Ambient Temperature	71.82	71.76	66.25	64.38	79	60	50	45.00
T <sub>4</sub>	Olive Oil + Ambient Temperature	69.09	68.89	61.45	61.33	79	61	53	47.00
T <sub>5</sub>	Almond Oil + Ambient Temperature	67.26	72.94	64.56	65.71	76	62	51	46.00
T <sub>6</sub>	Walnut Oil + Ambient Temperature	68.75	72.62	65.38	62.67	77	61	52	46.00
T <sub>7</sub>	Mustard Oil + Refrigerated Temperature	68.70	70.45	64.20	63.89	79	62	52	47.00
T <sub>8</sub>	Coconut Oil + Refrigerated Temperature	70.91	72.94	70.27	65.71	76	62	51	46.00
T <sub>9</sub>	Olive Oil + Refrigerated Temperature	67.83	66.30	60.47	60.00	78	61	52	48.00
T <sub>10</sub>	Almond Oil + Refrigerated Temperature	70.54	72.94	63.75	63.51	79	62	51	47.00
T <sub>11</sub>	Walnut Oil + Refrigerated Temperature	70.43	66.30	60.47	60.76	81	61	52	48.00
S.Em±		0.78	0.58	0.42	0.43	1	0.83	0.58	0.92
C.D. @ 5%		NS	2.96	2.12	2.17	NS	NS	NS	NS

**Table 5: Effect of various edible oil coatings on Color and Taste at ambient temperature and Refrigerated temperature**

Symbol	Treatments	Color				Taste			
		Days after Storage				Days after Storage			
		0	7	14	21	0	7	14	21
T <sub>1</sub>	Without Oil + Ambient Temperature	6.450	5.54	6.37	6	7.560	5.77	5.88	5.88
T <sub>2</sub>	Mustard Oil + Ambient Temperature	7.840	7.71	7.81	6.25	7.570	6.58	7.38	7.38
T <sub>3</sub>	Coconut Oil + Ambient Temperature	7.380	8.37	6.52	6.06	7.273	7.07	7.64	7.64
T <sub>4</sub>	Olive Oil + Ambient Temperature	6.270	6.61	6.97	6.81	7.690	8.50	7.33	7.33
T <sub>5</sub>	Almond Oil + Ambient Temperature	6.290	8.4	6.57	7.05	8.070	8.66	7.65	7.67
T <sub>6</sub>	Walnut Oil + Ambient Temperature	7.090	7.34	7.08	6.8	6.947	8.04	7.65	8.05
T <sub>7</sub>	Mustard Oil + Refrigerated Temperature	6.490	6.75	7.46	7.22	7.563	7.32	7.16	7.16
T <sub>8</sub>	Coconut Oil + Refrigerated Temperature	8.770	8.68	7.92	8.05	7.810	8.73	8.05	8.05
T <sub>9</sub>	Olive Oil + Refrigerated Temperature	8.230	8.58	7.86	7.83	7.623	6.19	7.26	7.26
T <sub>10</sub>	Almond Oil + Refrigerated Temperature	8.450	7.89	7.81	7.77	7.623	8.04	8.05	8.05
T <sub>11</sub>	Walnut Oil + Refrigerated Temperature	8.440	7.94	7.69	7.38	7.687	7.46	7.49	7.49
S.Em±		0.417	0.08	0.08	0.08	0.125	0.083	0.08	0.07
C.D. @ 5%		NS	0.41	0.41	0.42	NS	0.423	0.41	0.36





**Manju Danu et al.,**

**Table 6: Effect of various edible oil coatings on Texture and Flavor at ambient temperature and Refrigerated temperature**

Symbol	Treatments	Texture				Flavor			
		Days after Storage				Days after Storage			
		0	7	14	21	0	7	14	21
T <sub>1</sub>	Without Oil + Ambient Temperature	6.93	6.06	6.5	6.5	7.23	5.82	6.81	6.81
T <sub>2</sub>	Mustard Oil + Ambient Temperature	7.19	7.87	7.94	7.94	7.17	6.85	7.94	7.94
T <sub>3</sub>	Coconut Oil + Ambient Temperature	7.74	8.14	6.72	6.72	7.41	6.87	7.16	7.16
T <sub>4</sub>	Olive Oil + Ambient Temperature	7.7	7.5	7.92	7.92	8.04	7.61	7.06	7.06
T <sub>5</sub>	Almond Oil + Ambient Temperature	7.38	7.91	8.05	8.05	8.01	7.22	7.51	7.51
T <sub>6</sub>	Walnut Oil + Ambient Temperature	7.85	5.91	7.5	7.5	7.22	6.59	7.56	7.56
T <sub>7</sub>	Mustard Oil + Refrigerated Temperature	6.94	7.49	7.13	7.13	7.85	8.6	7.94	7.84
T <sub>8</sub>	Coconut Oil + Refrigerated Temperature	7.99	8.37	8.25	8.25	8.18	8.65	7.94	7.94
T <sub>9</sub>	Olive Oil + Refrigerated Temperature	7.86	6.53	7.16	7.16	7.66	7.34	7.86	7.86
T <sub>10</sub>	Almond Oil + Refrigerated Temperature	7.1	7.34	7.84	7.84	7.82	8.42	7.18	7.18
T <sub>11</sub>	Walnut Oil + Refrigerated Temperature	7.64	6.98	7.83	7.83	7.4	6.93	7.19	7.19
S.Em±		0.48	0.07	0.08	0.08	0.22	0.1	0.1	0.1
C.D. @ 5%		NS	0.36	0.42	0.42	NS	0.4	0.5	0.5

**Table 7: Effect of various edible oil coatings on overall acceptability of malta at ambient temperature and Refrigerated temperature**

Symbol	Treatments	Overall Acceptability			
		Days after Storage			
		0	7	14	21
T <sub>1</sub>	Without Oil + Ambient Temperature	7.72	5.8	6.72	6.72
T <sub>2</sub>	Mustard Oil + Ambient Temperature	7.44	7.7	7.38	7.38
T <sub>3</sub>	Coconut Oil + Ambient Temperature	7.33	7.99	6.89	6.89
T <sub>4</sub>	Olive Oil + Ambient Temperature	7.5	8.05	7.81	7.81
T <sub>5</sub>	Almond Oil + Ambient Temperature	7.43	8.06	7.64	7.64
T <sub>6</sub>	Walnut Oil + Ambient Temperature	7.07	6.68	7.28	7.28
T <sub>7</sub>	Mustard Oil + Refrigerated Temperature	7.65	7.1	7.35	7.35
T <sub>8</sub>	Coconut Oil + Refrigerated Temperature	8.24	8.53	7.96	7.96
T <sub>9</sub>	Olive Oil + Refrigerated Temperature	8.23	6.53	7.49	7.49
T <sub>10</sub>	Almond Oil + Refrigerated Temperature	7.68	7.79	7.53	7.53
T <sub>11</sub>	Walnut Oil + Refrigerated Temperature	7.86	7.32	7.47	7.47
S.Em±		0.40	0.07	0.08	0.08
C.D. @ 5%		NS	0.36	0.41	0.41





Manju Danu et al.,

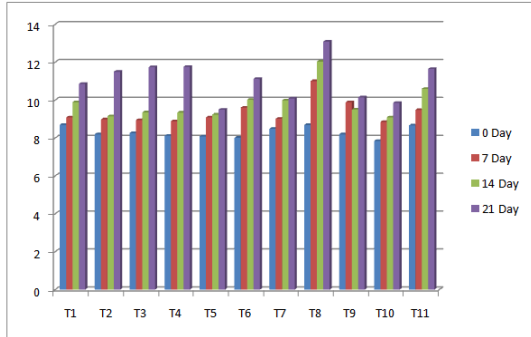


Fig 1: Effect of various edible oil coatings on Total Soluble solids at ambient temperature and Refrigerated temperature

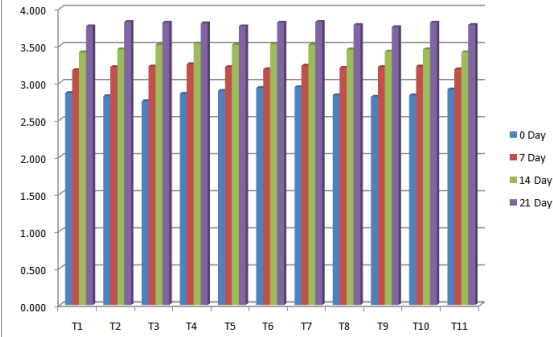


Fig 2: Effect of various edible oil coatings on pH at ambient temperature and Refrigerated temperature

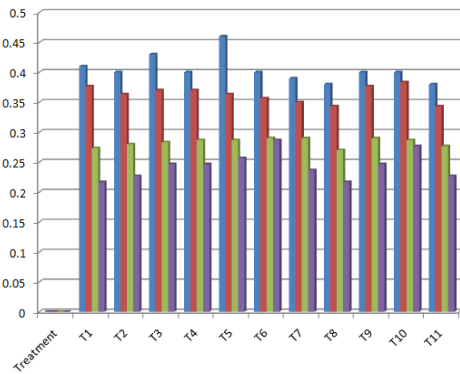


Fig 3: Effect of various edible oil coatings on Titratable Acidity at ambient temperature and Refrigerated temperature

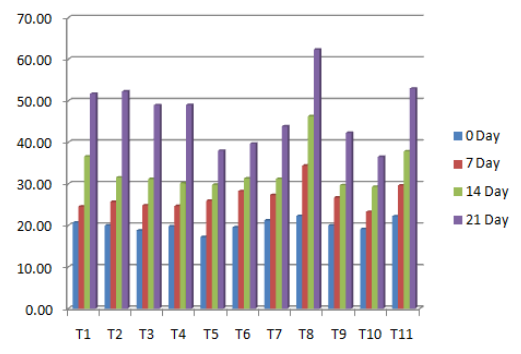


Fig 4: Effect of various edible oil coatings on TSS:Acid ratio at ambient temperature and Refrigerated temperature

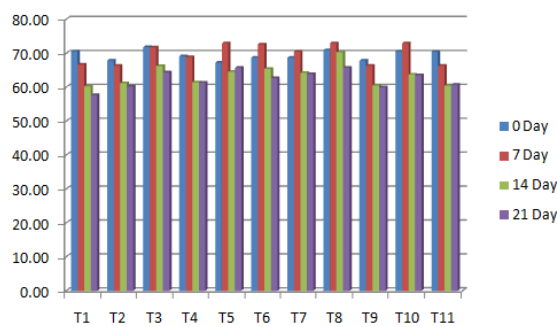


Fig 5: Effect of various edible oil coatings on Juice (%) ratio at ambient temperature and Refrigerated temperature

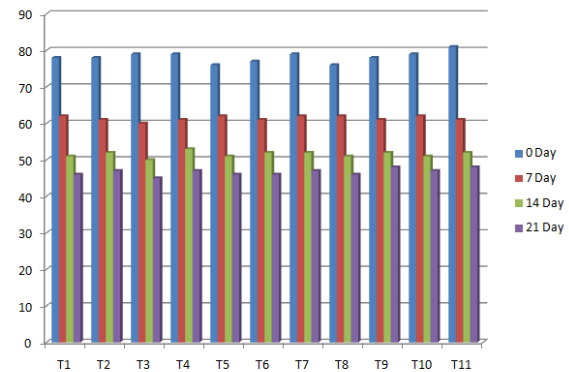


Fig 6: Effect of various edible oil coatings on Juice (ml) ratio at ambient temperature and Refrigerated temperature





## Carbon Capture by Biologically Mediated Way and Role of Carbonic Anhydrase : A Critical Review

Tamanna Deswal<sup>1</sup>, Shivani Narwal<sup>1</sup>, Azad Yadav<sup>1</sup> and Rajesh Dhankhar<sup>2\*</sup>

<sup>1</sup>Research Scholar, Department of Environmental Science, Maharshi Dayanand University, Rohtak, Haryana, India.

<sup>2</sup>Professor, Department of Environmental Science, Maharshi Dayanand University, Rohtak, Haryana, India.

Received: 13 Dec 2023

Revised: 10 Mar 2024

Accepted: 03 May 2024

### \*Address for Correspondence

**Rajesh Dhankhar**

Professor,

Department of Environmental Science,

Maharshi Dayanand University,

Rohtak, Haryana, India.

Email: rajeshdhankhar699@gmail.com

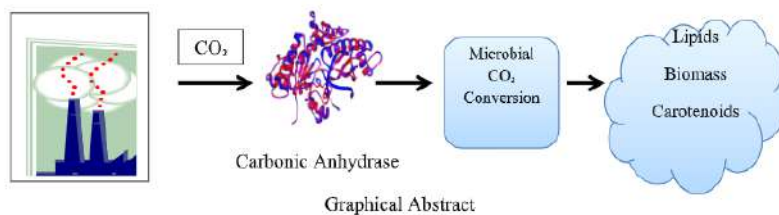


This is an Open Access Journal / article distributed under the terms of the **Creative Commons Attribution License (CC BY-NC-ND 3.0)** which permits unrestricted use, distribution, and reproduction in any medium, provided the original work is properly cited. All rights reserved.

### ABSTRACT

The increasing concentration of carbon dioxide (CO<sub>2</sub>) in the Earth's atmosphere has had a profound impact on the planet's balance. There is presently no approved technique or method for reducing CO<sub>2</sub> emissions, despite attempts being conducted on a global scale. To reduce CO<sub>2</sub> emissions, two primary strategies are being used, but in this present review we tried to focus on carbon capture via biological technique. The present study analyses i) the physiological processes of microalgae and focuses on their function in carbon capture, paying particular attention to the carbon concentration mechanism (CCM). ii) The RuBisCo ("Ribulose-1,5-bisphosphate carboxylase-oxygenase")-rich subcellular organelle known as the pyrenoid, which is an essential component of CCM in microalgae and vital role of Carbonic Anhydrase (CA) for CO<sub>2</sub> conversion into HCO<sub>3</sub><sup>-</sup> and its utilization by maintaining the pH in algal cells.iii) Also compare the economic viability of different CO<sub>2</sub> capture technologies with the help of their estimated cost.

**Keywords:** Biomass, Carbonic anhydrase, Climate change, Microalgae, RuBisCo



Tamanna Deswal *et al.*,

## INTRODUCTION

The increase in atmospheric carbon dioxide enhanced the risks associated with climate change by raising the atmospheric temperature. The level of carbon dioxide doubled, and the global temperature increased by over 2°C. CO<sub>2</sub> is a greenhouse gas that accounts for 68% of greenhouse gas emissions (GHGs) entering the atmosphere and contributes significantly to global warming [116]. The persistence of several animal and plant species, as well as people, is seriously threatened by climate change. Climate change has been made worse by the ongoing rise in release of various greenhouse gases, especially CO<sub>2</sub> (carbon dioxide), water vapor, CH<sub>4</sub> (methane), N<sub>2</sub>O (nitrous oxide) and fluorinated gases [39], [45]. Fossil fuel consumption is the main cause of the increase in GHG emissions, which are primarily attributed to human activities. The atmospheric CO<sub>2</sub> level on the planet has gone up from 313 ppm in 1960 to 411 ppm in 2020 [68]. A high atmospheric CO<sub>2</sub> concentration increases ocean water acidity, which has a severe negative impact on marine ecology [50]. Therefore, developing a suitable plan to lower or stabilize the atmospheric CO<sub>2</sub> level is urgently needed at this time. To reduce GHG emissions, many countries have ratified international agreements, such as the Paris Agreement (2015), Kyoto Protocol (1997), and COP26. These agreements aim to reduce CO<sub>2</sub> emissions, but there are two main strategies for lowering CO<sub>2</sub> emissions: (i) reducing the usage of fossil fuels while boosting the utilization of renewable energy sources; and (ii) CCS (“Carbon capture and storage”) through different chemical, biological, or physical techniques [105], [85]. CO<sub>2</sub> capture has three distinct technical advantages: Firstly, it lowers the atmospheric concentration of CO<sub>2</sub>; secondly, it lowers the release of CO<sub>2</sub> if CO<sub>2</sub> is to be taken from substantial static sources; and last, the CO<sub>2</sub> that is caught can be utilized as a feedstock or substrate to make chemicals and energy [28], [111]. Carbon dioxide storage and utilization can create new economic and career prospects in addition to these technical advantages.

Currently, there are numerous physical and chemical methods for capturing and storing carbon that are collectively known as CCS (Carbon capture and storage) methodologies as shown in Table 1. The three main steps of CCS are CO<sub>2</sub> capture, transit and storage. Large point sources, including power stations and cement mills, are used to capture CO<sub>2</sub>. The CO<sub>2</sub> capture and separation from different exhaust systems is done by the following processes: 1) Physical adsorption 2) Chemical absorption 3) Cryogenic distillation and 4) Membrane separation [30], [88]. Then, compressed CO<sub>2</sub> which is highly concentrated, shipped to storage locations [113]. After then, the collected CO<sub>2</sub> is deposited into reservoirs, which are oceanic and geological storage where it is directly injected deep into the ocean), aquifers, saline formations, or depleted oil and gas wells [63]. Despite the above-mentioned CCS’s impressive storage capacity, there are still a number of disadvantages, including costly operation and transit, the environmental risk of long-term CO<sub>2</sub> leakage, as well as other ambiguities [64], [26]. In addition, non-point, diffused emissions and small quantities of CO<sub>2</sub> cannot be trapped by CCS processes, they are only actually effective for trapping CO<sub>2</sub> from point sources producing large concentrations of CO<sub>2</sub> [83]. In addition to chemical and physical CCS, the biological pathway can be used to capture CO<sub>2</sub> through biological sinks: (i) forestation: afforestation, reforestation; cultivation of crops; and the subsequent valorization of biomass [28], [18]. (ii) Ocean fertilization: fertilizing the oceans with iron and other nutrients, which causes the phytoplankton to absorb more CO<sub>2</sub> [122].

(iii) Cultivation of microalgae [64].

One of the most significant and efficient carbon storage techniques in the world is biological carbon capture technology, particularly microalgal carbon dioxide fixation technology. Carbon dioxide fixation technology is long-term viable from an economic, environmental, and sustainability perspective [106]. The process of autotrophic organisms and plants converting CO<sub>2</sub> into carbon that is organic via photosynthesis to produce significant quantities of biomass is known as BCM or Biological carbon mitigation [111]. The primary emphasis of this review is on biological platforms, particularly on microalgae-based method. Microalgae are microscopic, single-celled photosynthetic organisms that belong to the group of algae. They are found in diverse aquatic environments, including freshwater, marine, and brackish water habitats. Microalgae are known for their ability to perform photosynthesis, using sunlight, carbon dioxide (CO<sub>2</sub>), and nutrients to produce organic matter and oxygen.





Tamanna Deswal et al.,

Microalgae contribute significantly to the oxygen in the atmosphere and absorb CO<sub>2</sub>, which is responsible for a substantial percentage (about 50%) of light harvesting process on Earth [22]. Biomass from algae produces a carbon-free, sustainable fuel source that is helpful to the environment by using carbon dioxide produced by human activities [93]. The efficiency of photosynthesis of microalgae typically ranges from 11 to 20%, which is higher than that of terrestrial plants (1-2%). During the exponential growth of a few algae species, their biomass was able to double in a span of three and a half hours. These microalgae are a fantastic option of organisms due to their advantages of higher carbon dioxide (flue gas) tolerance, low light intensity needs, environmental sustainability, and co-producing useful products [107], [48]. Microalgae hold significant potential for sustainable development and addressing environmental challenges. Their ability to photosynthesize, capture carbon dioxide, and their versatile applications make them a valuable resource for various sectors. Ongoing research is exploring ways to optimize microalgal cultivation, improve productivity, and harness their full potential for a range of applications.

### Carbon capture by Microalgae

Algae, both macro and micro-sized, are known for their efficiency in photosynthesis and their ability to incorporate CO<sub>2</sub> into biomass and energy. They are considered one of the most promising biofactories for carbon capture and utilization. Macroalgae, also known as seaweeds, have a high lipid content, making them suitable for direct extraction of oils that can be used in biodiesel production. These algae can be cultivated in coastal areas and have the advantage of fast growth rates. Micro-sized algae encompass a wide range of species, including diatoms, cyanobacteria, euglenoids, green algae, blue algae, red algae, brown algae, golden algae, and yellow algae. These microalgae have enormous potential for CO<sub>2</sub> fixation through enzymatic processes, primarily using the enzyme RuBisCo in the Calvin-Benson cycle.

The efficiency of micro-sized algae in fixing CO<sub>2</sub> varies among species, but they generally exhibit high rates of carbon dioxide absorption and conversion into biomass. As mentioned in literature, Approximately 1.84 kg of ambient carbon dioxide may be fixed by 1 kg of microalgae. This makes them valuable in the context of carbon capture and mitigation of greenhouse gas emissions. Furthermore, microalgae have additional benefits, such as their ability to grow in diverse environments, including saline or wastewater, which reduces the competition for arable land. They can also be cultivated using non-potable water sources, reducing the strain on freshwater resources. The potential of algae for CO<sub>2</sub> fixation and biofuel production has garnered significant attention in recent years. Research and development attempts are focused on optimizing algae cultivation techniques, improving lipid productivity, and developing cost-effective harvesting and processing methods. Fig 1 shows the four most significant groups of algae in terms of abundance [55].

By harnessing the capabilities of algae as photosynthetic biofactories, there is great potential to not only capture and utilize CO<sub>2</sub> but also to generate renewable energy sources such as biodiesel. However, further advancements in technology, scalability, and economic viability are necessary to realize the full potential of algae-based carbon capture and utilization systems. *Anabaena* affix 1.46 g/L/d of CO<sub>2</sub>, whereas *Chlorella vulgaris* affix 6.24 g/L/d of CO<sub>2</sub>. Bioenergy and biomass are created using CO<sub>2</sub> [19]. Growing these algae in close proximity to the sources of emissions can primarily lower increased CO<sub>2</sub> levels and generate vast amounts of biofuels and biomass [18]. The elements that should be taken into account before cultivating practises to acquire the greatest output are the choice of algae species, appropriate growth parameters, and suitable feedstock [36]. The ideal algal species should have the qualities listed below to maximise CO<sub>2</sub> biofixation and yield. Both the rate of integration and the capacity to collect carbon should be quite high. It should be able to withstand extreme CO<sub>2</sub> stress, use few nutrients appropriately, and be resilient to changes in temperature and H<sup>+</sup>, OH factors [1]. Table 2 shows the different algal strains that have been studied for carbon dioxide storage.

Microalgae play a significant role in carbon storage due to their ability to capture and store carbon dioxide (CO<sub>2</sub>) through photosynthesis. Here's how microalgae contribute to carbon storage:

1. Photosynthetic Carbon Fixation: Microalgae use photosynthesis to convert Carbon dioxide into organic compounds, mainly carbohydrates, lipids, and proteins. During light harvesting process, microalgae use sun





**Tamanna Deswalet al.,**

- light to convert CO<sub>2</sub> and water into glucose and oxygen. The captured carbon is then used to build cellular biomass.
2. **Biomass Accumulation:** As microalgae continue to photosynthesize and grow, they accumulate biomass, incorporating carbon from CO<sub>2</sub> into their cellular structures. This biomass represents a long-term carbon storage.
  3. **Carbon Storage in Lipids:** Some microalgae have the capability to produce high amounts of lipids or oils, which can serve as a significant carbon sink. These lipids can be extracted and processed for the production of biofuels, providing a renewable energy source while simultaneously carbon capture.
  4. **Carbon Transfer in Food Chains:** Microalgae are primary producers at the base of aquatic food chains. When consumed by higher trophic levels such as zooplankton, fish, or shellfish, the carbon stored in microalgal biomass is transferred and stored in their tissues. This can lead to indirect carbon storage in higher-level organisms.
  5. **Sedimentation and Burial:** As microalgae reach the end of their life cycle or experience cell death, their biomass can sink and be deposited in sediments or the ocean floor. Over time, these sediments can bury and store carbon for extended periods, contributing to long-term carbon storage.
  6. **Carbonate Precipitation:** Some microalgae, particularly coccolithophores, have the ability to form calcium carbonate (CaCO<sub>3</sub>) shells or plates. These calcium carbonate structures, when deposited in sediments or oceanic environments, contribute to the long-term storage of carbon.

It is important to note that the effectiveness of microalgae as carbon sequestrers rely on factors like microalgal species, growth situations, nutrient availability, and harvesting strategies. Additionally, the harvested biomass and derived products, such as biofuels, can have different carbon storage potentials depending on their utilization and fate after their use.

#### Sources of Microalgae

Microalgae can be found in various natural and man-made environments. Here are some common sources of microalgae as shown in Fig 2. It's important to note that the specific sources and species of microalgae may vary depending on geographical location, environmental conditions, and intended applications. Different microalgal strains are used for specific purposes, such as Carbon capture, biofuel production, bioremediation, food supplements, and pharmaceuticals as shown in Fig 3.

#### Physiochemical mechanism of Microalgae for Carbon capture

Microalgae are small organisms that live in marine and freshwater habitats. They are unicellular creatures that can live alone or in communities. They can be as little as a few micrometers (m) or as large as a few hundred micrometers, according to the species. They lack roots, stems, and leaves, in contrast to larger plants. They have the photosynthetic capacity using the CO<sub>2</sub> (greenhouse gas) for its photoautotrophic growth. They are known to generate nearly half of the oxygen in the atmosphere. The diversity of microalgae is enormous, and they are a nearly unexplored resource. In several distinct genera, it is thought that there are between 200,000 and 800,000 species, of which only 50,000 have been described. It has been scientifically determined that over 15,000 new chemicals derived from algal biomass [15]. The majority species of microalgae generate specific products such as toxins, peptides, carotenoids, fatty acids, sterols and antioxidants. Microalgal species stores all the carbons in the cell in the form of starch, lipids and proteins. Therefore microalgae is also a good option for producing biofuels. However, few species of microalgae have heterotrophic metabolism and have the ability to survive in dark conditions. Under specific circumstances, some strains of algae have mixotrophically growth. Because of the ability of microalgae to store the organic carbons that are present in wastewater and can eventually exhale to the atmosphere if decomposed by bacteria, the potential of microalgae to spread mixotrophically or heterotrophically is significant and dominating.

#### Photoautotrophic metabolism

A vast number of microalgae are photoautotrophs, converting CO<sub>2</sub> into carbohydrates through photosynthesis with inorganic carbon and light. Algal growth fix CO<sub>2</sub> through the Calvin-Benson cycle as shown in Fig 4, where the chemical Rubisco assumes a key part in changing over CO<sub>2</sub> into natural mixtures [72], [74]. The photosynthetic reaction that occurs in microalgae can be classified into 2 groups: the light reaction and the dark reaction. Light





Tamanna Deswalet al.,

drives the first phase of photosynthesis, during which  $\text{NADP}^+$  and ADP are transformed into energy-storing NADPH and ATP molecules [16]. The Calvin–Benson cycle is used in the second phase, or dark phase, to fix  $\text{CO}_2$  and assimilate it into organic compounds (glucose) produced in the first phase using NADPH and ATP [10]. Here, RuBisCo (Ribulosebiphosphate carboxylase/oxygenase) assumes a critical part in the storage of  $\text{CO}_2$  [102], [121].  $\text{CO}_2$  is transformed into 3-phosphoglycerate by Rubisco. However, Rubisco is not a good  $\text{CO}_2$  fixer because of its weak  $\text{CO}_2$  binding due to its oxygenase nature [102], [121]. After that, the production of carbohydrates involves these phosphoglycerates. Moreover, these phosphoglycerates are for most part used to recover RuBP, which is then utilized to proceed

with the carbon-fixing cycle. Phosphoglycolate, which is produced by RuBisCo's oxygenase activity, hinders activity of RuBisCo's carboxylase. Utilizing ATP and releasing Carbon dioxide, the phosphoglycolate is further transformed into phosphoglycerate (3-PGA). This response is known as photorespiration, in which  $\text{O}_2$  is used and  $\text{CO}_2$  is delivered [14]. Therefore, photorespiration consumes C and energy, which eventually reduces the output of light harvesting process. However, the oxygenase activity of Rubisco is bolstered by the fact that the concentration of  $\text{O}_2$  in the atmosphere is typically still higher than that of  $\text{CO}_2$  in the atmosphere. Microalgae have developed carbon concentrating mechanisms (CCMs) to improve  $\text{CO}_2$  concentrations within Rubisco's range to combat this situation [78], [101].

#### Heterotrophic metabolism

Organic carbon is required for heterotrophic metabolism, which can occur with or without solar energy. Although microalgae primarily use photoautotrophic growth, there are situations where a few microalgae can develop by means of heterotrophic digestion under dull or dim-light circumstances, that is inadequate for autotrophic digestion. These specific algae heterotrophically metabolise a large number of sources of organic carbon in these dim light settings [69], [76], [115]. The pentose phosphate pathway (PPP) is followed by this metabolism, which uses organic carbons from acetate, lactate, glucose, and glycerol. It also makes use of a range of enzymes that are involved in respiration, anabolic and catabolic metabolism, phosphorylation, transport, and other processes [37]. Photoheterotrophy, on the contrary, is the process by which heterotrophy can take place in the presence of light in a small number of algal strains [44]. The cultivation of heterotrophic microalgae has the following characteristics: (i) a comparably higher capacity to absorb light and grow; (ii) a rapid rate of growth; what's more (iii) the ability to use different sorts of assets of natural carbon sources [76]. Many microalgal variants have been studied for the generation of biomass and different key metabolites under heterotrophic conditions utilising glucose as a carbon source [89], [125].

#### Mixotrophic metabolism

Mixotrophic metabolism involves the simultaneous utilization of autotrophic photosynthesis and heterotrophic absorption. This digestion can be viewed as a subordinate of the heterotrophic digestion as both  $\text{CO}_2$  and natural carbon are utilized simultaneously. The highest glucose utilisation is achieved through mixotrophic metabolism, which also involves respiration and photosynthesis [65]. Mixotrophic metabolism can therefore utilize both inorganic and organic carbon, resulting in a high biomass production [75], [118]. The natural carbon is caught by means of vigorous breath, though inorganic carbon is consumed through photosynthesis [41]. In comparison to autotrophic or heterotrophic cultivations, mixotrophic microalgae cultivation yields more cells per unit of energy input [126]. Moreover, mixotrophic digestion shows a lower energy-change productivity contrasted with heterotrophic digestion [126]. Be that as it may, both these mechanism safeguard the significant colors and photosynthetic carotenoids under sun powered illumination [13], [27]. Mixotrophic cultivation has some profits over photoautotrophic cultivation, like a faster rate of development, fewer development cycles, a negligible decrease in biomass in the dim light, and overall higher biomass yields [61], [86]. Contrarily, mixotrophic metabolisms have several disadvantages of their own, such as the vulnerability to invasive heterotrophic bacteria in bare pond settings and the cost, which is considerable owing to the high need for organic carbon supplies [87]. Additionally, the mixotrophic mechanism faces another obstacle when trying to strike a balance between the two types of metabolisms. Besides, adjusting two sorts of digestion systems is one more test for the mixotrophic mechanism.







Tamanna Deswalet al.,

**Mechanism of CCM (Carbon Concentration Mechanism)**

The aquatic photosynthetic microorganisms account for half of the world's photosynthesis [29]. At pH levels above 7 and temperatures below 30°C,  $\text{HCO}_3^-$  is the primary form of Carbon dioxide in  $\text{H}_2\text{O}$ . One advantage of amphibian capture of carbon is that the non-gaseous form of Carbon dioxide,  $\text{HCO}_3^-$ , directly supports growth of algae and formation of biomass. However, when it comes to obtaining  $\text{CO}_2$  from the atmosphere, these aquatic microorganisms face both benefits and drawbacks. One significant challenge they encounter is the slow and low-affinity nature of the enzyme RuBisCO, which is responsible for  $\text{CO}_2$  assimilation. RuBisCO can only utilize up to 25% of its catalytic activity at ambient  $\text{CO}_2$  levels because the concentration of broken down Carbon dioxide is lower than the  $K_m$  (Michaelis constant) of RuBisCO. Higher levels of Oxygen compete with Carbon dioxide during the catalytic process. These organisms observe significant variations in inorganic carbon levels ( $\text{CO}_2$  and  $\text{HCO}_3^-$ ), which influence the pH of the surrounding environment and consequently affect the presence of  $\text{CO}_2$  and  $\text{HCO}_3^-$  for light harvesting process. In an acidic pH environment,  $\text{CO}_2$  is the predominant form of inorganic carbon, whereas in an alkaline pH environment,  $\text{HCO}_3^-$  is the prevalent form [11], [35]. As a result, aquatic photosynthetic microorganisms that contain chlorophyll have been able to overcome obstacles and survive at low concentration of carbon dioxide thanks to the development of CCM. It has been accounted that there are 3 sorts of CCM's in nature [78]

**$\text{C}_4$  mechanism:** As the first completely stated photosynthetic carbon concentrating mechanism (CCM), the  $\text{C}_4$  mechanism is largely seen in higher plants. Phosphoenolpyruvate carboxylase fixes  $\text{CO}_2$  through this method, resulting in the creation of a four-carbon acid. This four-carbon acid is subsequently transferred and decarboxylated, giving RuBisCO, the Calvin cycle enzyme, a larger quantity of  $\text{CO}_2$  [94], [101].

**Inorganic carbon active transportation:** The previously described carbon concentrating mechanism (CCM) in cyanobacteria has been thoroughly investigated. The CCM of cyanobacteria is clearly characterised and involves active absorption of both  $\text{CO}_2$  and  $\text{HCO}_3^-$  species, which is made possible by specific cells termed carboxysomes. These intracellular microcompartments are essential to the cyanobacteria's CCM[9], [91].

**Concentration of  $\text{CO}_2$  rising around the RuBisCO enzyme:** This type of carbon concentrating mechanism (CCM) relies on the establishment of pH gradients over the chloroplast and thylakoid membranes, and it is predominantly present in eukaryotic algae. In the existence of light, the stroma of chloroplast maintains 8 pH, while the lumen of thylakoid has 4-5 pH, resulting in a significant pH difference over the membrane of thylakoid. Due to this pH gradient, bicarbonate is the predominant inorganic carbon ( $\text{C}_i$ ) species in the stroma of chloroplast, while  $\text{CO}_2$  remains in the primary form in the lumen of thylakoid. Any  $\text{HCO}_3^-$  that enters the lumen of thylakoid is rapidly changed into  $\text{CO}_2$  through the action of a carbonic anhydrase (CA) enzyme present in the lumen of thylakoid, thus increasing the accessibility of Carbon dioxide to RuBisCO. This conversion process from  $\text{HCO}_3^-$  to  $\text{CO}_2$  was proposed by Pronina and Semenenko[92].

The processes through which algae can store  $\text{CO}_2$  are listed in Table 3. They vary from biophysical processes that either involve the active transport of DIC across one or more cellular membranes or the localised enhancement of external concentration of  $\text{CO}_2$  by acidification of the external medium to biochemical  $\text{C}_4$  and CAM mechanisms that involve additional DIC (Dissolved Inorganic Carbon) fixation in addition to that by RuBisCO.

**CA (Carbonic Anhydrase)**

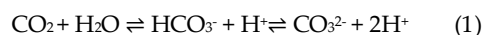
CA is an enzyme that catalyzes the reversible interconversion of  $\text{CO}_2$  and  $\text{H}_2\text{O}$  (water) into  $\text{HCO}_3^-$  (bicarbonate ion) and  $\text{H}^+$  (hydrogen ion). It plays an important part in different physiological processes which includes  $\text{CO}_2$  transport, pH regulation, and bicarbonate ion production. The primary objective of the enzyme carbonic anhydrase is to speed up the  $\text{CO}_2$  and water reaction, which is quite sluggish without it. By facilitating this reaction, CA helps maintain the balance of  $\text{CO}_2$  and  $\text{HCO}_3^-$  in biological systems. There are several isotypes of CA, which are found in various tissues and have specific functions. Carbonic anhydrase is present in various organisms, including mammals, plants, and bacteria. In mammals, carbonic anhydrase is found in RBCs, where it assists in the transport of  $\text{CO}_2$  from tissues to the lungs for elimination. It also takes part in the regulation of acid-base balance in the body by participating in the





**Tamanna Deswal et al.,**

transformation of CO<sub>2</sub> and H<sub>2</sub>O into HCO<sub>3</sub><sup>-</sup> and H<sup>+</sup> ions. Carbonic Anhydrase is a Zn-containing enzyme that aids in Carbon dioxide fixation via a nucleophilic assault by an ion of hydroxide attached to a Zn atom. This is followed by the ionisation of the water molecule coupled to zinc, which regenerates the active site, and the removal of a proton from the active site, as shown in Eq. (1) [101]. As a result, CA's take part in fixation of carbon which converts HCO<sub>3</sub><sup>-</sup> to CO<sub>2</sub>, which serves as a substrate for RuBisCO, the main enzyme for fixation of carbon in algae and plants.

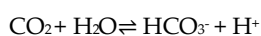


In plants, carbonic anhydrase is involved in photosynthesis. It helps convert CO<sub>2</sub> into HCO<sub>3</sub><sup>-</sup> in the chloroplasts, allowing for efficient carbon fixation and subsequent synthesis of sugars. In addition to its physiological roles, carbonic anhydrase has been the subject of research for various applications, including the development of drugs for conditions such as glaucoma, epilepsy, and cancer. Overall, carbonic anhydrase is an important enzyme involved in carbon dioxide metabolism and pH regulation in biological systems, playing a vital role in maintaining homeostasis. The five types of carbonic anhydrase and their characteristics are described in table 4.

### Role of CA in CCM

CA (Carbonic anhydrase) plays a crucial role in carbon storage in microalgae by facilitating the interconversion of CO<sub>2</sub> (carbon dioxide) and HCO<sub>3</sub><sup>-</sup> (bicarbonate) ions as shown in Fig 5. Here's a brief overview of the role of CA in carbon capture in microalgae:

1. Conversion of CO<sub>2</sub> to HCO<sub>3</sub><sup>-</sup>: CA catalyzes the reversible hydration of Carbon dioxide to form HCO<sub>3</sub><sup>-</sup>. This reaction is represented as:



The enzyme carbonic anhydrase accelerates the hydration reaction, allowing the efficient conversion of CO<sub>2</sub> to bicarbonate ions within microalgal cells.

2. Bicarbonate Utilization: Bicarbonate ions are an essential carbon source for microalgae. They are actively transported into the cells through specific transporters. Inside the cells, bicarbonate is further utilized by carbonic anhydrase for various metabolic processes, including photosynthesis.
3. Enhancement of CO<sub>2</sub> Concentration: By catalyzing the conversion of CO<sub>2</sub> to bicarbonate ions, carbonic anhydrase helps maintain a high concentration of CO<sub>2</sub> in the vicinity of the photosynthetic enzyme, RuBisCo (ribulose-1,5-bisphosphate carboxylase/oxygenase). This high Carbon dioxide concentration facilitates the fixation of Carbon dioxide by RuBisCo, increasing the efficiency of light harvesting process.
4. pH Regulation: Carbonic anhydrase also plays a role in pH regulation within microalgal cells. The conversion of CO<sub>2</sub> to bicarbonate ions helps buffer the pH by consuming excess H<sup>+</sup> ions produced during metabolic processes. This pH regulation is important for maintaining optimal enzymatic activities and overall cell function.

By facilitating the conversion of CO<sub>2</sub> to bicarbonate ions and maintaining an optimal carbon concentration, carbonic anhydrase enables microalgae to efficiently capture and utilize CO<sub>2</sub> for growth and photosynthesis. This contributes to the storage of CO<sub>2</sub> from the environment, aiding in the mitigation of greenhouse gas ejection and storage of carbon in microalgal biomass.

### Mechanism of CA

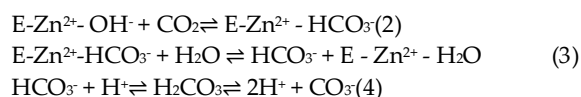
The mechanism of CA involves a Zinc ion (Zn<sup>2+</sup>) at the active site, which is coordinated with 3 residues of histidine (His) in the enzyme's active site as shown in figure 6. Histidine side chains control three places on a Zn prosthetic group in the Carbonic Anhydrase enzyme. The CO<sub>2</sub> gets closer to OH group which is attached to Zn<sup>2+</sup> by the Enzyme's "E" active site which contain a particular space for Carbon dioxide. This causes the attack of OH<sup>-</sup> which is electron rich in nature to CO<sub>2</sub> for HCO<sub>3</sub><sup>-</sup> molecule formation. In many cases, the CO<sub>2</sub> molecule which is found in hydrophobic pocket is attacked by the Zn-OH<sup>-</sup> for the formation of Zn bound bicarbonate ion (Eq. (2)). The H<sub>2</sub>O





**Tamanna Deswal et al.,**

molecule replace the  $\text{HCO}_3^-$  which is bound with the Zinc, release bicarbonate ion (Eq. (3)). The bicarbonate ion present in the solution can procure an Hydrogen ion to form carbonic acid or dropping the Hydrogen ion to form carbonate ion (Eq. (4)). The methods of CA-catalyzed mediation for better  $\text{CO}_2$  collection, conversion, and utilisation are summarised in Table 5.



### Factors affecting Carbon capture in Microalgae

Carbon capture in microalgae, which are microscopic photosynthetic organisms, can be influenced by various factors. Here are some key factors that can affect carbon capture in microalgae:

**7.1 Light Availability:** Microalgae require sufficient light for photosynthesis, which is the procedure by which they convert  $\text{CO}_2$  into organic matter, including carbohydrates and lipids. Light intensity, duration, and quality (wavelength) can affect the rate of photosynthesis and, consequently, carbon capture in microalgae. The photosynthesis reaction comprises two phases: the light-dependent reaction and the light-independent reaction. The photon molecules are transformed into the biological substance in NADPH and ATP by a light-dependent process. When RuBisCo is present, it is employed to fix or sequester carbon in the Calvin-Benson cycle [67]. As a outcome, the Calvin-Benson cycle of C capture in microalgae requires optimal irradiance [76]. The rate of photosynthetic activity changes as a result of low and high light intensity. Microalgae often enhance their light-capturing mechanisms (chlorophylls) as effectively as feasible when there is minimal light energy. Instead, strong light intensities change PS II's acceptor-side activity and prevent electrons from moving from  $\text{QA}^-$  to  $\text{QB}^-$ . As a result, more charge recombination occurs, which encourages the creation of P680, which combines with oxygen to create singlet oxygen [4]. Microalgae utilise light energy through the processes of photoacclimation and photo-limitation, two well-known phenomena [90]. The steady loss of photosynthetic pigments (mostly chlorophylls a and b) in reciprocation to higher irradiation was described as the photoacclimation notion. If the pigment content of cells rises, it's probable that certain cells won't have access to photon molecules and will need to develop a larger photosynthetic apparatus. Singlet oxygen's extremely reactive nature led to oxidative loss in the Photosystem II. It is well known that reduced photosynthetic rates and, subsequently, low C fixation and biomass production under high light stress are caused by oxidative stress brought on by singlet oxygen or ROS (reactive oxygen species) [31], [103].

**Nutrient Availability:** Microalgae need important nutrients such as N, P and micronutrients for growth and photosynthesis. The accessibility and stability of these nutrients can impact the productivity and carbon storage capacity of microalgae. Nutrient limitation or excess can influence the growth rate and lipid production, which affects carbon storage.

**Carbon Dioxide Concentration:** Microalgae use  $\text{CO}_2$  as a carbon source for photosynthesis. Higher concentrations of  $\text{CO}_2$  in the growth environment can stimulate photosynthesis and carbon storage in microalgae. Therefore, the availability of  $\text{CO}_2$ , either naturally or through enhanced supply, can impact their carbon capture potential. According to a study, *Chlorella vulgaris* grows best at 5% (v/v)  $\text{CO}_2$  concentrations and is inhibited at 15% (v/v)  $\text{CO}_2$  concentrations (Yun et al., 1997). In general, acidification in the chloroplast stroma area inhibits the development of microalgae at high  $\text{CO}_2$  concentrations by inactivating the Calvin-Benson cycle's essential enzymes [109].

**Temperature:** Temperature plays a critical role in the growth and metabolic activities of microalgae. Optimal temperatures promote photosynthesis, growth, and carbon fixation, leading to increased carbon storage. However, extreme temperatures outside the optimal range can inhibit microalgal growth and reduce their carbon storage capacity. The activity of the enzyme Carboxylase and Rubisco, which is crucial for photosynthesis and photorespiration, is decreased by a low temperature, which hinders the mechanism of capture of carbon in algae.



**Tamanna Deswal et al.,**

Similar to humans, microalgae experience photorespiration and metabolic activity changes at extremely high temperatures [81]. An rise in temperature causes a decrease in CO<sub>2</sub> solubility in the liquid media used to cultivate algae, and these two variables are inversely related.

**pH and Carbonate Chemistry:** pH and carbonate chemistry of the growth medium influence the availability of dissolved inorganic carbon (DIC) forms, including CO<sub>2</sub>, bicarbonate (HCO<sub>3</sub><sup>-</sup>), and carbonate (CO<sub>3</sub><sup>2-</sup>) ions. The balance of these forms can affect the efficiency of carbon uptake/capture in microalgae. Except for certain cyanobacteria, microalgal culture primarily exhibits optimal growth in the pH ranges of 6.5 to 8.5. However, an alkaline (high) pH is advantageous for CO<sub>2</sub> absorption since it rises the amount of free CO<sub>2</sub> in the culture medium, which encourages the algal development that can withstand high CO<sub>2</sub> concentrations [5]. According to a recent study, pH has no notable impact on C absorption below 9.52 millimol/L and pH 10.6-7.0; however, above that concentration, pH significantly affects carbon absorption [127]. The inorganic cultivation medium often uses bicarbonate (HCO<sub>3</sub><sup>-</sup>) as a carbon source. By converting HCO<sub>3</sub><sup>-</sup> into OH<sup>-</sup>, carbonic anhydrase raises pH levels and changes the balance of various inorganic carbon (Ci) species.

**Strain Selection:** Different species and strains of microalgae exhibit variations in their growth rates, lipid content, and carbon capture capacities. Selecting high-productivity strains that are efficient at carbon capture can enhance the overall carbon storage potential of microalgae. According to reports, microalgae may grow in a range of 5 to 40°C, with 0 to 30°C being the ideal temperature [2].

**Culture Conditions:** Factors such as mixing/agitation, culture density, aeration, and availability of trace elements can impact microalgal growth, photosynthesis, and carbon capture. Optimizing culture conditions to provide a favourable environment for microalgae can enhance their carbon storage performance. Understanding and manipulating these factors can help optimize microalgal growth and maximize their carbon storage potential. It is important to note that various factors interact and may have trade-offs, necessitating a balanced approach in managing microalgal carbon storage systems.

**Analyses of various CO<sub>2</sub> capture technologies' for economic viability**

Economic considerations play a crucial role in assessing the viability of different CO<sub>2</sub> capture technologies. Several factors are taken into account when evaluating the economics of these technologies: Capital costs, operating costs, CO<sub>2</sub> capture efficiency, CO<sub>2</sub> utilization and storage, Scalability, Regulatory and policy environment. Some chemical, physical, and algal approaches' projected costs are shown in Table 6 based on published research. The challenges and costs associated with various CO<sub>2</sub> capture and storage methods, including chemical reaction-based methods using substances like monoethanolamine (MEA), amine and potassium hydroxide (KOH). These methods require multiple steps and involve the use of strong chemical reagents. They also require significant energy amount for separation, transportation and storage of CO<sub>2</sub>, often requiring high temperatures and pressures for the regeneration process. The estimated price for separation and compression of CO<sub>2</sub>, for transportation purposes is around \$30-50 per ton of Carbon dioxide. The costs of storage and transportation are approximate to be \$1-3 per ton of CO<sub>2</sub>, respectively. However, these costs can vary depending on factors such as the CO<sub>2</sub> content in the waste gas and the actual industrial flue gas, which typically has relatively low CO<sub>2</sub> content (10-20%). The lower CO<sub>2</sub> content, the higher the costs of gathering and capture. A broad techno-economic scrutiny of CO<sub>2</sub> capture using scrubbing of amine and found that the capture costs were approximately \$55 per ton [56]. Additionally, the costs of Carbon dioxide capture are also influenced by the capacity of the power plant, which corresponds to the CO<sub>2</sub> production capacity.

As examples of physical carbon trapping systems, deep ocean injection and subterranean storage are proposed. Due to the potential for leakage during storage and transportation, these techniques can only significantly slow down the emission of CO<sub>2</sub> and are therefore neither ecologically beneficial nor sustainable. Similar restrictions apply to physical adsorption systems utilising activated carbon, zeolite, Calcium oxide and MOFs (metal-organic frameworks), where the stored CO<sub>2</sub> is not acceptable for use. The CaO-based calcium looping method has comparatively modest collection costs, costing around \$20 per tonne of CO<sub>2</sub>[70].





Tamanna Deswal et al.,

When compared to chemical and physical approaches, the price of microalgae-based mitigation of Carbon dioxide are often greater, especially when paired with the generation of biofuel. Without value-added use, CO<sub>2</sub> storage by algal biomass accumulation is economically disadvantageous. The CO<sub>2</sub> absorption, energy input/output, expenses, and income were all examined in a study by Ventura et al. (2013) that looked at several scenarios combining microalgae-based Carbon dioxide storage with alternative production of bioenergy methods (such as biodiesel, biogas, and syngas).

## CONCLUSION

Microalgae have high efficiency for carbon fixation and its biomass growth, making them suitable for carbon capture. They can assimilate both organic and inorganic carbon from point and non-point sources, making them adaptable for different carbon sources. Microalgae have better efficiency in light harvesting process because they use sunlight to affix Carbon dioxide and store it in their organelles. They have created a Carbon Concentrating Mechanism comprised of Carbonic Anhydrase that aids in collection as well as absorbing ambient CO<sub>2</sub> and turning it into biomass for further utilization by maintaining the pH in the algal cells. Various areas of technology development are necessary for the commercialization of microalgae-based carbon capture. This includes addressing sources of carbon with various chemical forms and distribution traits, masking and genetically modified high-performance strains, application of waste gases from industries, figuring out the process of carbon fixation by microalgae-based method, enhancing the transfer of Carbon dioxide and desorption of O<sub>2</sub>, optimizing production processes, efficient microalgae harvesting and conversion technologies and the evolution of higher quality goods. Techno-economic study employing production facilities of a realistic scale is essential to determining the economic feasibility of microalgae-based technologies. Understanding and improving the economic feasibility will help determine the cost-effectiveness and potential profitability of these microalgal based technologies. Technologies for reducing carbon emissions based on microalgae can be developed and extensively used, providing considerable economic and environmental advantages in the near future for carbon sequestration and to reduce greenhouse gases emission.

### Declaration of Interest

The authors declare that they have no known competing financial interests or personal relationship that may seem to have affect the work present in this study.

## REFERENCES

1. AbdRahaman, M. S., Cheng, L. H., Xu, X. H., Zhang, L., & Chen, H. L. (2011). A review of carbon dioxide capture and utilization by membrane integrated microalgal cultivation processes. *Renewable and Sustainable Energy Reviews*, 15(8), 4002-4012. <https://doi.org/10.1016/j.rser.2011.07.031>
2. Al Jabri, H., Taleb, A., Touchard, R., Saadaoui, I., Goetz, V., & Pruvost, J. (2021). Cultivating microalgae in desert conditions: Evaluation of the effect of light-temperature summer conditions on the growth and metabolism of *Nannochloropsis* QU130. *Applied Sciences*, 11(9), 3799.
3. Alvizo, O., Nguyen, L. J., Savile, C. K., Bresson, J. A., Lakhapatri, S. L., Solis, E. O., ... & Lalonde, J. J. (2014). Directed evolution of an ultrastable carbonic anhydrase for highly efficient carbon capture from flue gas. *Proceedings of the National Academy of Sciences*, 111(46), 16436-16441. <https://doi.org/10.1073/pnas.1411461111>
4. Aro, E. M., Virgin, I., & Andersson, B. (1993). Photoinhibition of photosystem II. Inactivation, protein damage and turnover. *Biochimica et Biophysica Acta (BBA)-Bioenergetics*, 1143(2), 113-134.
5. Azov, Y. (1982). Effect of pH on inorganic carbon uptake in algal cultures. *Applied and environmental microbiology*, 43(6), 1300-1306.
6. Badger, M. R., & Price, G. D. (2003). CO<sub>2</sub> concentrating mechanisms in cyanobacteria: molecular components, their diversity and evolution. *Journal of experimental botany*, 54(383), 609-622.





## Tamanna Deswalet al.,

7. Badger, M. R., Andrews, T. J., Whitney, S. M., Ludwig, M., Yellowlees, D. C., Leggat, W., & Price, G. D. (1998). The diversity and coevolution of Rubisco, plastids, pyrenoids, and chloroplast-based CO<sub>2</sub>-concentrating mechanisms in algae. *Canadian Journal of Botany*, 76(6), 1052-1071. <https://doi.org/10.1139/b98-074>
8. Badger, M. R., Hanson, D., & Price, G. D. (2002). Evolution and diversity of CO<sub>2</sub> concentrating mechanisms in cyanobacteria. *Functional Plant Biology*, 29(3), 161-173.
9. Badger, M. R., Price, G. D., Long, B. M., & Woodger, F. J. (2006). The environmental plasticity and ecological genomics of the cyanobacterial CO<sub>2</sub> concentrating mechanism. *Journal of experimental botany*, 57(2), 249-265. <https://doi.org/10.1093/jxb/eri286>
10. Bassham, J. A., Benson, A. A., Kay, L. D., Harris, A. Z., Wilson, A. T., & Calvin, M. (1954). The path of carbon in photosynthesis. XXI. The cyclic regeneration of carbon dioxide acceptor1. *Journal of the American chemical society*, 76(7), 1760-1770. <https://doi.org/10.1021/ja01636a012>
11. Beardall, J. (1981). CO<sub>2</sub> ACCUMULATION BY CHLORELLA SACCHAROPHILA (CHLOROPHYCEAE) AT LOW EXTERNAL pH: EVIDENCE FOR ACTIVE TRANSPORT OF INORGANIC CARBON AT THE CHLOROPLAST ENVELOPE 1. *Journal of Phycology*, 17(4), 371-373. <https://doi.org/10.1111/j.1529-8817.1981.tb00864.x>
12. Beedlow, P. A., Tingey, D. T., Phillips, D. L., Hogsett, W. E., & Olszyk, D. M. (2004). Rising atmospheric CO<sub>2</sub> and carbon sequestration in forests. *Frontiers in Ecology and the Environment*, 2(6), 315-322. [https://doi.org/10.1890/1540-9295\(2004\)002\[0315:RACACS\]2.0.CO;2](https://doi.org/10.1890/1540-9295(2004)002[0315:RACACS]2.0.CO;2)
13. Bhatnagar, A., Chinnasamy, S., Singh, M., & Das, K. C. (2011). Renewable biomass production by mixotrophic algae in the presence of various carbon sources and wastewaters. *Applied energy*, 88(10), 3425-3431. <https://doi.org/10.1016/j.apenergy.2010.12.064>
14. Bowes, G., Ogren, W. L., & Hageman, R. H. (1971). Phosphoglycolate production catalyzed by ribulosediphosphate carboxylase. *Biochemical and biophysical research communications*, 45(3), 716-722. [https://doi.org/10.1016/0006-291X\(71\)90475-X](https://doi.org/10.1016/0006-291X(71)90475-X)
15. Cardozo, K. H., Guaratini, T., Barros, M. P., Falcão, V. R., Tonon, A. P., Lopes, N. P., ... & Pinto, E. (2007). Metabolites from algae with economical impact. *Comparative Biochemistry and Physiology Part C: Toxicology & Pharmacology*, 146(1-2), 60-78. <https://doi.org/10.1016/j.cbpc.2006.05.007>
16. Carvalho, A. P., Silva, S. O., Baptista, J. M., & Malcata, F. X. (2011). Light requirements in microalgal photobioreactors: an overview of biophotonic aspects. *Applied microbiology and biotechnology*, 89, 1275-1288. <https://doi.org/10.1007/s00253-010-3047-8>
17. Cassia R., Nocioni M., Correa-Aragunde N., Lamattina L., (2018). Climate Change and the Impact of Greenhouse Gasses: CO<sub>2</sub> and NO, Friends and Foes of Plant Oxidative Stress. *Frontiers in Plant Science*, 9: 273. <https://doi.org/10.3389/fpls.2018.00273>
18. Cheah, W. Y., Show, P. L., Chang, J. S., Ling, T. C., & Juan, J. C. (2015). Biosequestration of atmospheric CO<sub>2</sub> and flue gas-containing CO<sub>2</sub> by microalgae. *Bioresource technology*, 184, 190-201. <https://doi.org/10.1016/j.biortech.2014.11.026>
19. Chen, P., Min, M., Chen, Y., Wang, L., Li, Y., Chen, Q., ... & Ruan, R. (2010). Review of biological and engineering aspects of algae to fuels approach. *International Journal of Agricultural and Biological Engineering*, 2(4), 1-30. DOI: 10.3965/j.issn.1934-6344.2009.04.001-030
20. Cole, I. S., Corrigan, P., Sim, S., & Biribilis, N. (2011). Corrosion of pipelines used for CO<sub>2</sub> transport in CCS: Is it a real problem?. *International Journal of Greenhouse Gas Control*, 5(4), 749-756. <https://doi.org/10.1016/j.ijggc.2011.05.010>
21. Colman, B., Huertas, I. E., Bhatti, S., & Dason, J. S. (2002). The diversity of inorganic carbon acquisition mechanisms in eukaryotic microalgae. *Functional Plant Biology*, 29(3), 261-270.
22. Cuellar-Bermudez S.P., Garcia-Perez J.S., Rittmann B.E., Parra-Saldivar R., (2015). Photosynthetic bioenergy utilizing CO<sub>2</sub>: an approach on flue gases utilization for third generation biofuels. *Journal of Cleaner Production*, 98: 53-65.
23. De Morais, M. G., & Costa, J. A. V. (2007). Biofixation of carbon dioxide by *Spirulina* sp. and *Scenedesmus obliquus* cultivated in a three-stage serial tubular photobioreactor. *Journal of biotechnology*, 129(3), 439-445. <https://doi.org/10.1016/j.jbiotec.2007.01.009>





## Tamanna Deswalet al.,

24. deMorais, M. G., & Costa, J. A. V. (2007). Isolation and selection of microalgae from coal fired thermoelectric power plant for biofixation of carbon dioxide. *Energy Conversion and Management*, 48(7), 2169-2173. <https://doi.org/10.1016/j.enconman.2006.12.011>
25. de Oliveira, C. Y. B., Viegas, T. L., da Silva, M. F. O., Fracalossi, D. M., Lopes, R. G., & Derner, R. B. (2020). Effect of trace metals on growth performance and accumulation of lipids, proteins, and carbohydrates on the green microalga *Scenedesmus obliquus*. *Aquaculture International*, 28(4), 1435-1444.
26. De Silva, G. P. D., Ranjith, P. G., & Perera, M. S. A. (2015). Geochemical aspects of CO<sub>2</sub> sequestration in deep saline aquifers: A review. *Fuel*, 155, 128-143. <https://doi.org/10.1016/j.fuel.2015.03.045>
27. Del Campo, J. A., García-González, M., & Guerrero, M. G. (2007). Outdoor cultivation of microalgae for carotenoid production: current state and perspectives. *Applied microbiology and biotechnology*, 74, 1163-1174. <https://doi.org/10.1007/s00253-007-0844-9>
28. Farrelly, D. J., Everard, C. D., Fagan, C. C., & McDonnell, K. P. (2013). Carbon sequestration and the role of biological carbon mitigation: a review. *Renewable and sustainable energy reviews*, 21, 712-727. <https://doi.org/10.1016/j.rser.2012.12.038>
29. Field, C. B., Behrenfeld, M. J., Randerson, J. T., & Falkowski, P. (1998). Primary production of the biosphere: integrating terrestrial and oceanic components. *science*, 281(5374), 237-240. DOI: 10.1126/science.281.5374.237
30. Figueroa, J. D., Fout, T., Plasynski, S., McIlvried, H., & Srivastava, R. D. (2008). Advances in CO<sub>2</sub> capture technology—the US Department of Energy's Carbon Sequestration Program. *International journal of greenhouse gas control*, 2(1), 9-20.
31. Foyer, C. H., & Shigeoka, S. (2011). Understanding oxidative stress and antioxidant functions to enhance photosynthesis. *Plant physiology*, 155(1), 93-100.
32. Fradette, S., Gingras, J., Carley, J., Kelly, G. R., & Ceperkovic, O. (2019). *U.S. Patent*
33. Fu, Y., Jiang, Y. B., Dunphy, D., Xiong, H., Coker, E., Chou, S. S., ...& Brinker, C. J. (2018). Ultra-thin enzymatic liquid membrane for CO<sub>2</sub> separation and capture. *Nature communications*, 9(1), 990. <https://doi.org/10.1038/s41467-018-03285-x>
34. García-Camacho, F., Sánchez-Mirón, A., Molina-Grima, E., Camacho-Rubio, F., & Merchuck, J. C. (2012). A mechanistic model of photosynthesis in microalgae including photoacclimation dynamics. *Journal of theoretical biology*, 304, 1-15.
35. GEHL, K. A., Cook, C. M., & Colman, B. (1987). The effect of external pH on the apparent CO<sub>2</sub> affinity of *Chlorella saccharophila*. *Journal of experimental botany*, 38(7), 1203-1210. <https://doi.org/10.1093/jxb/38.7.1203>
36. Ghorbani, A., Rahimpour, H. R., Ghasemi, Y., Zoughi, S., & Rahimpour, M. R. (2014). A review of carbon capture and sequestration in Iran: microalgal biofixation potential in Iran. *Renewable and Sustainable Energy Reviews*, 35, 73-100. <https://doi.org/10.1016/j.rser.2014.03.013>
37. Giordano, M., Beardall, J., & Raven, J. A. (2005). CO<sub>2</sub> concentrating mechanisms in algae: mechanisms, environmental modulation, and evolution. *Annu. Rev. Plant Biol.*, 56, 99-131. <https://doi.org/10.1146/annurev.arplant.56.032604.144052>
38. Gomez-Villa, H., Voltolina, D., Nieves, M., & Pina, P. (2005). Biomass production and nutrient budget in outdoor cultures of *Scenedesmus obliquus* (Chlorophyceae) in artificial wastewater, under the winter and summer conditions of Mazatlan, Sinaloa, Mexico. *Vie et Milieu/Life & Environment*, 121-126.
39. Hansen, J., Sato, M., Ruedy, R., Lacis, A., & Oinas, V. (2000). Global warming in the twenty-first century: An alternative scenario. *Proceedings of the National Academy of Sciences*, 97(18), 9875-9880. <https://doi.org/10.1073/pnas.170278997>
40. Ho, S. H., Chen, C. Y., Lee, D. J., & Chang, J. S. (2011). Perspectives on microalgal CO<sub>2</sub>-emission mitigation systems—a review. *Biotechnology advances*, 29(2), 189-198. <https://doi.org/10.1016/j.biotechadv.2010.11.001>
41. Hu, B., Min, M., Zhou, W., Li, Y., Mohr, M., Cheng, Y., ...& Ruan, R. (2012). Influence of exogenous CO<sub>2</sub> on biomass and lipid accumulation of microalgae *Auxenochlorella protothecoides* cultivated in concentrated municipal wastewater. *Applied biochemistry and biotechnology*, 166, 1661-1673. <https://doi.org/10.1007/s12010-012-9566-2>





Tamanna Deswalet al.,

42. Hunt, A. J., Sin, E. H., Marriott, R., & Clark, J. H. (2010). Generation, capture, and utilization of industrial carbon dioxide. *ChemSusChem: Chemistry & Sustainability Energy & Materials*, 3(3), 306-322. <https://doi.org/10.1002/cssc.200900169>
43. Huntley, M. E., & Redalje, D. G. (2007). CO<sub>2</sub> mitigation and renewable oil from photosynthetic microbes: a new appraisal. *Mitigation and adaptation strategies for global change*, 12, 573-608. <https://doi.org/10.1007/s11027-006-7304-1>
44. Ingram, L. O., Calder, J. A., Van Baalen, C., Plucker, F. E., & Parker, P. L. (1973). Role of reduced exogenous organic compounds in the physiology of the blue-green bacteria (algae): photoheterotrophic growth of a "heterotrophic" blue-green bacterium. *Journal of Bacteriology*, 114(2), 695-700.
45. IPCC. Special Report on Emissions Scenarios: A Special Report of Working Group III of the Intergovernmental Panel on Climate Change; Cambridge University Press: New York, NY, USA, 2014; ISBN 92-9169-1135.
46. Iwasaki, I., Hu, Q., Kurano, N., & Miyachi, S. (1998). Effect of extremely high-CO<sub>2</sub> stress on energy distribution between photosystem I and photosystem II in a 'high-CO<sub>2</sub>' tolerant green alga, *Chlorococum littorale* and the intolerant green alga *Stichococcus bacillaris*. *Journal of Photochemistry and Photobiology B: Biology*, 44(3), 184-190. [https://doi.org/10.1016/S1011-1344\(98\)00140-7](https://doi.org/10.1016/S1011-1344(98)00140-7)
47. Jacob-Lopes, E., Scoparo, C. H. G., Lacerda, L. M. C. F., & Franco, T. T. (2009). Effect of light cycles (night/day) on CO<sub>2</sub> fixation and biomass production by microalgae in photobioreactors. *Chemical Engineering and Processing: Process Intensification*, 48(1), 306-310. <https://doi.org/10.1016/j.cep.2008.04.007>
48. Jaiswal K.K., Banerjee I., Singh D., Sajwan P., Chhetri V., (2020a). Ecological stress stimulus to improve microalgae biofuel generation: a review. *Octa Journal of Biosciences*, 8 (1): 48–54.
49. Johnston, A. M., Raven, J. A., Beardall, J., & Leegood, R. C. (2001). Photosynthesis in a marine diatom. *Nature*, 412(6842), 40-41.
50. Joint, I., Doney, S. C., & Karl, D. M. (2011). Will ocean acidification affect marine microbes?. *The ISME journal*, 5(1), 1-7.
51. Jun, S. H., Yang, J., Jeon, H., Kim, H. S., Pack, S. P., Jin, E., & Kim, J. (2020). Stabilized and immobilized carbonic anhydrase on electrospun nanofibers for enzymatic CO<sub>2</sub> conversion and utilization in expedited microalgal growth. *Environmental Science & Technology*, 54(2), 1223-1231. <https://doi.org/10.1021/acs.est.9b05284>
52. Kadam, K. L. (1997). Power plant flue gas as a source of CO<sub>2</sub> for microalgae cultivation: economic impact of different process options. *Energy Conversion and Management*, 38, S505-S510. [https://doi.org/10.1016/S0196-8904\(96\)00318-4](https://doi.org/10.1016/S0196-8904(96)00318-4)
53. Kaplan, A., & Reinhold, L. (1999). CO<sub>2</sub> concentrating mechanisms in photosynthetic microorganisms. *Annual review of plant biology*, 50(1), 539-570.
54. Keeley, J. E., & Rundel, P. W. (2003). Evolution of CAM and C<sub>4</sub> carbon-concentrating mechanisms. *International journal of plant sciences*, 164(S3), S55-S77.
55. Khan, S. A., Hussain, M. Z., Prasad, S., & Banerjee, U. C. (2009). Prospects of biodiesel production from microalgae in India. *Renewable and sustainable energy reviews*, 13(9), 2361-2372. <https://doi.org/10.1016/j.rser.2009.04.005>
56. Kierzkowska, A. M., Pacciani, R., & Müller, C. R. (2013). CaO-based CO<sub>2</sub> sorbents: from fundamentals to the development of new, highly effective materials. *ChemSusChem*, 6(7), 1130-1148. <https://doi.org/10.1002/cssc.201300178>
57. Kim, H. S., Hong, S. G., Woo, K. M., TeijeiroSeijas, V., Kim, S., Lee, J., & Kim, J. (2018). Precipitation-based nanoscale enzyme reactor with improved loading, stability, and mass transfer for enzymatic CO<sub>2</sub> conversion and utilization. *ACS Catalysis*, 8(7), 6526-6536. <https://doi.org/10.1021/acscatal.8b00606>
58. Kishimoto, M., Okakura, T., Nagashima, H., Minowa, T., Yokoyama, S. Y., & Yamaberi, K. (1994). CO<sub>2</sub> fixation and oil production using micro-algae. *Journal of Fermentation and Bioengineering*, 78(6), 479-482. [https://doi.org/10.1016/0922-338X\(94\)90052-3](https://doi.org/10.1016/0922-338X(94)90052-3)
59. Kita, J., & Ohsumi, T. (2004). Perspectives on biological research for CO<sub>2</sub> ocean sequestration. *Journal of oceanography*, 60, 695-703. <https://doi.org/10.1007/s10872-004-5762-1>







## Tamanna Deswal et al.,

60. Kittel, J., Idem, R., Gelowitz, D., Tontiwachwuthikul, P., Parrain, G., & Bonnaeu, A. (2009). Corrosion in MEA units for CO<sub>2</sub> capture: pilot plant studies. *Energy Procedia*, 1(1), 791-797. <https://doi.org/10.1016/j.egypro.2009.01.105>
61. Kong, W. B., Song, H., Hua, S. F., Yang, H., Yang, Q., & Xia, C. G. (2012). Enhancement of biomass and hydrocarbon productivities of *Botryococcus braunii* by mixotrophic cultivation and its application in brewery wastewater treatment. *African Journal of Microbiology Research*, 6(7), 1489-1496. DOI: 10.5897/AJMR11.1349
62. Kumar, A., Yuan, X., Sahu, A. K., Dewulf, J., Ergas, S. J., & Van Langenhove, H. (2010). A hollow fiber membrane photo-bioreactor for CO<sub>2</sub> sequestration from combustion gas coupled with wastewater treatment: a process engineering approach. *Journal of Chemical Technology & Biotechnology*, 85(3), 387-394. <https://doi.org/10.1002/jctb.2332>
63. Lackner, K. S. (2003). A guide to CO<sub>2</sub> sequestration. *Science*, 300(5626), 1677-1678.
64. Lam, M. K., Lee, K. T., & Mohamed, A. R. (2012). Current status and challenges on microalgae-based carbon capture. *International Journal of Greenhouse gas control*, 10, 456-469. <https://doi.org/10.1016/j.ijggc.2012.07.010>
65. Lee, Y. (2004). Algal nutrition: heterotrophic carbon nutrition. *Handbook of microalgal culture: Biotechnology and Applied Phycology*, 116-124.
66. Li, G., Xiao, P., Webley, P., Zhang, J., Singh, R., & Marshall, M. (2008). Capture of CO<sub>2</sub> from high humidity flue gas by vacuum swing adsorption with zeolite 13X. *Adsorption*, 14, 415-422. <https://doi.org/10.1007/s10450-007-9100-y>
67. Liang, F., Lindberg, P., & Lindblad, P. (2018). Engineering photoautotrophic carbon fixation for enhanced growth and productivity. *Sustainable Energy & Fuels*, 2(12), 2583-2600. DOI: 10.1039/C8SE00281A
68. Lindsey, R. Climate Change: Atmospheric Carbon Dioxide; National Oceanic and Atmospheric Administration: Copenhagen, Denmark, 2020.
69. Lowrey, J., Armenta, R. E., & Brooks, M. S. (2016). Nutrient and media recycling in heterotrophic microalgae cultures. *Applied microbiology and biotechnology*, 100, 1061-1075. <https://doi.org/10.1007/s00253-015-7138-4>
70. MacKenzie, A., Granatstein, D. L., Anthony, E. J., & Abanades, J. C. (2007). Economics of CO<sub>2</sub> capture using the calcium cycle with a pressurized fluidized bed combustor. *Energy & fuels*, 21(2), 920-926. <https://doi.org/10.1021/ef0603378>
71. Martínez, L., Redondas, V., García, A. I., & Morán, A. (2011). Optimization of growth operational conditions for CO<sub>2</sub> biofixation by native *Synechocystis* sp. *Journal of Chemical Technology & Biotechnology*, 86(5), 681-690. <https://doi.org/10.1002/jctb.2568>
72. Matito-Martos, I., Sepulveda, C., Gomez, C., Acién, G., Perez-Carbajo, J., Delgado, J. A., ... & Anta, J. A. (2021). Potential of CO<sub>2</sub> capture from flue gases by physicochemical and biological methods: A comparative study. *Chemical Engineering Journal*, 417, 128020. <https://doi.org/10.1016/j.cej.2020.128020>
73. Miao, X., & Wu, Q. (2004). High yield bio-oil production from fast pyrolysis by metabolic controlling of *Chlorella protothecoides*. *Journal of biotechnology*, 110(1), 85-93. <https://doi.org/10.1016/j.jbiotec.2004.01.013>
74. Min, M., Hu, B., Zhou, W., Li, Y., Chen, P., & Ruan, R. (2012). Mutual influence of light and CO<sub>2</sub> on carbon sequestration via cultivating mixotrophic alga *Auxenochlorella protothecoides* UMN280 in an organic carbon-rich wastewater. *Journal of applied phycology*, 24, 1099-1105. <https://doi.org/10.1007/s10811-011-9739-3>
75. Mohan, S. V., & Devi, M. P. (2014). Salinity stress induced lipid synthesis to harness biodiesel during dual mode cultivation of mixotrophic microalgae. *Bioresource technology*, 165, 288-294. <https://doi.org/10.1016/j.biortech.2014.02.103>
76. Morales-Sánchez, D., Martínez-Rodríguez, O. A., Kyndt, J., & Martínez, A. (2015). Heterotrophic growth of microalgae: metabolic aspects. *World Journal of Microbiology and Biotechnology*, 31, 1-9. <https://doi.org/10.1007/s11274-014-1773-2>
77. Morel, F. M., Cox, E. H., Kraepiel, A. M., Lane, T. W., Milligan, A. J., Schaperdorth, I., ... & Tortell, P. D. (2002). Acquisition of inorganic carbon by the marine diatom *Thalassiosira weissflogii*. *Functional plant biology*, 29(3), 301-308.
78. Moroney, J. V., Jungnick, N., DiMario, R. J., & Longstreth, D. J. (2013). Photorespiration and carbon concentrating mechanisms: two adaptations to high O<sub>2</sub>, low CO<sub>2</sub> conditions. *Photosynthesis research*, 117, 121-131. <https://doi.org/10.1007/s1120-013-9865-7>





## Tamanna Deswalet al.,

79. Murakami, M., & Ikenouchi, M. (1997). The biological CO<sub>2</sub> fixation and utilization project by rite (2)—Screening and breeding of microalgae with high capability in fixing CO<sub>2</sub>—. *Energy Conversion and Management*, 38, S493-S497. [https://doi.org/10.1016/S0196-8904\(96\)00316-0](https://doi.org/10.1016/S0196-8904(96)00316-0)
80. Negoro, M., Shioji, N., Miyamoto, K., & Micira, Y. (1991). Growth of microalgae in high CO<sub>2</sub> gas and effects of SO<sub>x</sub> and NO<sub>x</sub>. *Applied biochemistry and biotechnology*, 28, 877-886. <https://doi.org/10.1007/BF02922657>
81. Nianjun, X., & Xuecheng, Z. (2001). Effect of temperature, light intensity and pH on the growth and fatty acid compositions of *Ellipsoidion* sp. *Journal of Ocean University of Qingdao*, 31(4), 541-547.
82. Norsker, N. H., Barbosa, M. J., Vermuë, M. H., & Wijffels, R. H. (2011). Microalgal production—a close look at the economics. *Biotechnology advances*, 29(1), 24-27. <https://doi.org/10.1016/j.biotechadv.2010.08.005>
83. Nouha, K., John, R. P., Yan, S., Tyagi, R. D., Surampalli, R. Y., & Zhang, T. C. (2015). Carbon capture and sequestration: biological technologies. *Carbon Capture and Storage: Physical, Chemical, and Biological Methods*, 65-111.
84. Olajire, A. A. (2013). A review of mineral carbonation technology in sequestration of CO<sub>2</sub>. *Journal of Petroleum Science and Engineering*, 109, 364-392. <https://doi.org/10.1016/j.petrol.2013.03.013>
85. Osman, A. I., Hefny, M., Abdel Maksoud, M. I. A., Elgarahy, A. M., & Rooney, D. W. (2021). Recent advances in carbon capture storage and utilisation technologies: a review. *Environmental Chemistry Letters*, 19(2), 797-849. <https://doi.org/10.1007/s10311-020-01133-3>
86. Park, K. C., Whitney, C., McNichol, J. C., Dickinson, K. E., MacQuarrie, S., Skrupski, B. P., ...& McGinn, P. J. (2012). Mixotrophic and photoautotrophic cultivation of 14 microalgae isolates from Saskatchewan, Canada: potential applications for wastewater remediation for biofuel production. *Journal of Applied Phycology*, 24, 339-348. <https://doi.org/10.1007/s10811-011-9772-2>
87. Patel, A. K., Choi, Y. Y., & Sim, S. J. (2020). Emerging prospects of mixotrophic microalgae: Way forward to sustainable bioprocess for environmental remediation and cost-effective biofuels. *Bioresource Technology*, 300, 122741. <https://doi.org/10.1016/j.biortech.2020.122741>
88. Pires, J. C. M., Martins, F. G., Alvim-Ferraz, M. C. M., & Simões, M. (2011). Recent developments on carbon capture and storage: An overview. *Chemical engineering research and design*, 89(9), 1446-1460. <https://doi.org/10.1016/j.cherd.2011.01.028>
89. Pleissner, D., Lam, W. C., Sun, Z., & Lin, C. S. K. (2013). Food waste as nutrient source in heterotrophic microalgae cultivation. *Bioresource technology*, 137, 139-146. <https://doi.org/10.1016/j.biortech.2013.03.088>
90. Pniewski, F., & Piasecka-Jędrzejak, I. (2020). Photoacclimation to constant and changing light conditions in a benthic diatom. *Frontiers in Marine Science*, 7, 381.
91. Price, G. D., & Badger, M. R. (1989). Isolation and characterization of high CO<sub>2</sub>-requiring-mutants of the cyanobacterium *Synechococcus* PCC7942: two phenotypes that accumulate inorganic carbon but are apparently unable to generate CO<sub>2</sub> within the carboxysome. *Plant physiology*, 91(2), 514-525. <https://doi.org/10.1104/pp.91.2.514>
92. Pronina, N. A., & Semenenko, V. E. (1990). Membrane-bound carbonic anhydrase takes part in CO<sub>2</sub> concentration in algae cells. In *Current Research in Photosynthesis: Proceedings of the VIIIth International Conference on Photosynthesis Stockholm, Sweden, August 6–11, 1989* (pp. 3283-3286). Dordrecht: Springer Netherlands. [https://doi.org/10.1007/978-94-009-0511-5\\_739](https://doi.org/10.1007/978-94-009-0511-5_739)
93. Rahman F.A., Aziz M.M.A., Saidur R., Bakar W.A.W.A., Hainin M.R., Putrajaya R., Hassan N.A., (2017). Pollution to solution: Capture and sequestration of carbon dioxide (CO<sub>2</sub>) and its utilization as a renewable energy source for a sustainable future. *Renewable and Sustainable Energy Reviews*, 71: 112-126. <https://doi.org/10.1016/j.rser.2017.01.011>
94. Raven, J. A. (2003). Inorganic carbon concentrating mechanisms in relation to the biology of algae. *Photosynthesis Research*, 77, 155-171. <https://doi.org/10.1023/A:1025877902752>
95. Reinfelder, J. R., Kraepiel, A. M., & Morel, F. M. (2000). Unicellular C<sub>4</sub> photosynthesis in a marine diatom. *Nature*, 407(6807), 996-999.
96. Reinfelder, J. R., Milligan, A. J., & Morel, F. M. (2004). The role of the C<sub>4</sub> pathway in carbon accumulation and fixation in a marine diatom. *Plant Physiology*, 135(4), 2106-2111.





## Tamanna Deswalet al.,

97. Ryan, C., Hartley, A., Browning, B., Garvin, C., Greene, N., & Steger, C. (2009). Cultivating clean energy. *The promise of algae biofuels*. Springer, Singapore, 1-65.
98. Ryu, H. J., Oh, K. K., & Kim, Y. S. (2009). Optimization of the influential factors for the improvement of CO<sub>2</sub> utilization efficiency and CO<sub>2</sub> mass transfer rate. *Journal of Industrial and engineering chemistry*, 15(4), 471-475. <https://doi.org/10.1016/j.jiec.2008.12.012>
99. Sakai, N., Sakamoto, Y., Kishimoto, N., Chihara, M., & Karube, I. (1995). Chlorella strains from hot springs tolerant to high temperature and high CO<sub>2</sub>. *Energy Conversion and Management*, 36(6-9), 693-696. [https://doi.org/10.1016/0196-8904\(95\)00100-R](https://doi.org/10.1016/0196-8904(95)00100-R)
100. Salek, S. S., Kleerebezem, R., Jonkers, H. M., Witkamp, G. J., & Van Loosdrecht, M. C. (2013). Mineral CO<sub>2</sub> sequestration by environmental biotechnological processes. *Trends in biotechnology*, 31(3), 139-146. <https://doi.org/10.1016/j.tibtech.2013.01.005>
101. Sayre, R. (2010). Microalgae: the potential for carbon capture. *Bioscience*, 60(9), 722-727. <https://doi.org/10.1525/bio.2010.60.9.9>
102. Schloss, J. V. (2002). Oxygen toxicity from plants to people. *Planta*, 216, 38-43. <https://doi.org/10.1007/s00425-002-0905-3>
103. Sharma, P., Jha, A. B., Dubey, R. S., & Pessarakli, M. (2012). Reactive oxygen species, oxidative damage, and antioxidative defense mechanism in plants under stressful conditions. *Journal of botany*, 2012.
104. Sheehan, J., Dunahay, T., Benemann, J., & Roessler, P. (1998). A look back at the US Department of Energy's aquatic species program: biodiesel from algae. *National Renewable Energy Laboratory*, 328, 1-294.
105. Shreyash, N.; Sonker, M.; Bajpai, S.; Tiwary, S.K.; Khan, M.A. The Review of Carbon Capture-Storage Technologies and Developing Fuel Cells for Enhancing Utilization. *Energies* 2021, 14, 4978. <https://doi.org/10.3390/en14164978>
106. Sialve B, Bernet N, Bernard O. Anaerobic digestion of microalgae as a necessary step to make microalgal biodiesel sustainable. *Biotechnol Adv* 2009;27(4):409–16.
107. Singh U.B., Ahluwalia A.S., (2013). Microalgae: a promising tool for carbon sequestration. *Mitigation and Adaptation Strategies for Global Change*, 18(1): 73-95.
108. Singh, J., Tripathi, R., & Thakur, I. S. (2014). Characterization of endolithic cyanobacterial strain, *Leptolyngbya* sp. ISTCY101, for prospective recycling of CO<sub>2</sub> and biodiesel production. *Bioresource technology*, 166, 345-352. <https://doi.org/10.1016/j.biortech.2014.05.055>
109. Solovchenko, A., & Khozin-Goldberg, I. (2013). High-CO<sub>2</sub> tolerance in microalgae: possible mechanisms and implications for biotechnology and bioremediation. *Biotechnology letters*, 35, 1745-1752.
110. Srikanth, S., Alvarez-Gallego, Y., Vanbroekhoven, K., & Pant, D. (2017). Enzymatic electrosynthesis of formic acid through carbon dioxide reduction in a bioelectrochemical system: effect of immobilization and carbonic anhydrase addition. *ChemPhysChem*, 18(22), 3174-3181. <https://doi.org/10.1002/cphc.201700017>
111. Stepan, D. J., Shockey, R. E., Moe, T. A., & Dorn, R. (2002). Carbon dioxide sequestering using microalgal systems. Univ. of North Dakota, Grand Forks, ND (United States). <https://doi.org/10.2172/882000>
112. Sung, K. D., Lee, J. S., Shin, C. S., & Park, S. C. (1999). Isolation of a new highly CO<sub>2</sub> tolerant fresh water microalga *Chlorella* sp. KR-1. *Renewable energy*, 16(1-4), 1019-1022. [https://doi.org/10.1016/S0960-1481\(98\)00362-0](https://doi.org/10.1016/S0960-1481(98)00362-0)
113. Svensson, R., Odenberger, M., Johnsson, F., & Strömberg, L. (2004). Transportation systems for CO<sub>2</sub>—application to carbon capture and storage. *Energy conversion and management*, 45(15-16), 2343-2353. <https://doi.org/10.1016/j.enconman.2003.11.022>
114. Sydney, E. B., Sturm, W., de Carvalho, J. C., Thomaz-Soccol, V., Larroche, C., Pandey, A., & Soccol, C. R. (2010). Potential carbon dioxide fixation by industrially important microalgae. *Bioresource technology*, 101(15), 5892-5896. <https://doi.org/10.1016/j.biortech.2010.02.088>
115. Tuchman, N. C., Schollett, M. A., Rier, S. T., & Geddes, P. (2006). Differential heterotrophic utilization of organic compounds by diatoms and bacteria under light and dark conditions. *Advances in algal biology: A commemoration of the work of Rex Lowe*, 167-177. [https://doi.org/10.1007/1-4020-5070-4\\_12](https://doi.org/10.1007/1-4020-5070-4_12)
116. Usui N, Ikenouchi M. The biological CO<sub>2</sub> fixation and utilization project by RITE (1) Highly-effective photobioreactor system. *Energy Convers Manag* 1997;38:S487–S492. [https://doi.org/10.1016/S0196-8904\(96\)00315-9](https://doi.org/10.1016/S0196-8904(96)00315-9)





## Tamanna Deswal et al.,

117. Ventura J-RS, Yang B, Lee Y-W, Lee K, Jahng D. Life cycle analyses of CO<sub>2</sub>, energy, and cost for four different routes of microalgal bioenergy conversion. *Bioresource Technology*. 2013;137:302–10.
118. Wang, J., Yang, H., & Wang, F. (2014). Mixotrophic cultivation of microalgae for biodiesel production: status and prospects. *Applied biochemistry and biotechnology*, 172, 3307-3329. <https://doi.org/10.1007/s12010-014-0729-1>
119. Wang, L., & Shevlin, P. B. (1996). 212 th ACS National Meeting. *Reports of Division of Medicinal Chemistry*(Orlando), 002.
120. White, C. M., Strazisar, B. R., Granite, E. J., Hoffman, J. S., Pennline, H. W., & Air & Waste Management Association (2003). Separation and capture of CO<sub>2</sub> from large stationary sources and sequestration in geological formations—coalbeds and deep saline aquifers. *Journal of the Air & Waste Management Association (1995)*, 53(6), 645–715. <https://doi.org/10.1080/10473289.2003.10466206>
121. Williams, P. J. L. B., & Laurens, L. M. (2010). Microalgae as biodiesel & biomass feedstocks: Review & analysis of the biochemistry, energetics & economics. *Energy & environmental science*, 3(5), 554-590. <https://doi.org/10.1039/B924978H>
122. Williamson, P., Wallace, D. W., Law, C. S., Boyd, P. W., Collos, Y., Croot, P., ... & Vivian, C. (2012). Ocean fertilization for geoengineering: a review of effectiveness, environmental impacts and emerging governance. *Process Safety and Environmental Protection*, 90(6), 475-488. <https://doi.org/10.1016/j.psep.2012.10.007>
123. Winter, K., & Smith, J. A. C. (Eds.). (2012). *Crassulacean acid metabolism: biochemistry, ecophysiology and evolution* (Vol. 114). Springer Science & Business Media.
124. Xiong, W., Gao, C., Yan, D., Wu, C., & Wu, Q. (2010). Double CO<sub>2</sub> fixation in photosynthesis–fermentation model enhances algal lipid synthesis for biodiesel production. *Bioresource technology*, 101(7), 2287-2293. <https://doi.org/10.1016/j.biortech.2009.11.041>
125. Yan, D., Lu, Y., Chen, Y. F., & Wu, Q. (2011). Waste molasses alone displaces glucose-based medium for microalgal fermentation towards cost-saving biodiesel production. *Bioresource technology*, 102(11), 6487-6493. <https://doi.org/10.1016/j.biortech.2011.03.036>
126. Yang, C., Hua, Q., & Shimizu, K. (2000). Energetics and carbon metabolism during growth of microalgal cells under photoautotrophic, mixotrophic and cyclic light-autotrophic/dark-heterotrophic conditions. *Biochemical engineering journal*, 6(2), 87-102. [https://doi.org/10.1016/S1369-703X\(00\)00080-2](https://doi.org/10.1016/S1369-703X(00)00080-2)
127. Yin, D., Wang, Z., Wen, X., Ding, Y., Hou, X., Geng, Y., & Li, Y. (2019). Effects of carbon concentration, pH, and bubbling depth on carbon dioxide absorption ratio in microalgae medium. *Environmental Science and Pollution Research*, 26, 32902-32910.
128. You, S. K., Ko, Y. J., Shin, S. K., Hwang, D. H., Kang, D. H., Park, H. M., & Han, S. O. (2020). Enhanced CO<sub>2</sub> fixation and lipid production of *Chlorella vulgaris* through the carbonic anhydrase complex. *Bioresource technology*, 318, 124072. <https://doi.org/10.1016/j.biortech.2020.124072>
129. Yu, S., Lv, P., Xue, P., Wang, K., Yang, Q., Zhou, J., ...& Tan, T. (2021). Light-driven enzymatic nanosystem for highly selective production of formic acid from CO<sub>2</sub>. *Chemical Engineering Journal*, 420, 127649. <https://doi.org/10.1016/j.cej.2020.127649>
130. Yue, L., & Chen, W. (2005). Isolation and determination of cultural characteristics of a new highly CO<sub>2</sub> tolerant fresh water microalgae. *Energy conversion and management*, 46(11-12), 1868-1876. <https://doi.org/10.1016/j.enconman.2004.10.010>
131. Yun, Y. S., Lee, S. B., Park, J. M., Lee, C. I., & Yang, J. W. (1997). Carbon dioxide fixation by algal cultivation using wastewater nutrients. *Journal of Chemical Technology & Biotechnology: International Research in Process, Environmental and Clean Technology*, 69(4), 451-455.
132. Zhou, W., Wang, J., Chen, P., Ji, C., Kang, Q., Lu, B., ...& Ruan, R. (2017). Bio-mitigation of carbon dioxide using microalgal systems: Advances and perspectives. *Renewable and Sustainable Energy Reviews*, 76, 1163-1175. <https://doi.org/10.1016/j.rser.2017.03.065>
133. deMorais, M. G., & Costa, J. A. V. (2007). Isolation and selection of microalgae from coal fired thermoelectric power plant for biofixation of carbon dioxide. *Energy Conversion and Management*, 48(7), 2169-2173. <https://doi.org/10.1016/j.enconman.2006.12.011>





**Tamanna Deswal et al.,**

**Table 1. Comparison of CO<sub>2</sub> capture strategies.**

Classification	Approach	Procedure	Advantages	Disadvantages	References
1. Chemical	Chemical absorption	Formation of carbonates or bicarbonates by neutralization of carbonic acid.	<ul style="list-style-type: none"> <li>• Secure and long term storage.</li> <li>• Solubility of CO<sub>2</sub> is high.</li> </ul>	<ul style="list-style-type: none"> <li>• Requirement of large size equipment.</li> <li>• Energy requirement is high.</li> </ul>	[20], [60]
	Mineral carbonation	Formation of stable carbonates via the reaction of CO <sub>2</sub> with metal oxides.	<ul style="list-style-type: none"> <li>• Permanent and safe storage.</li> <li>• After storage, stable carbonates are utilized.</li> </ul>	<ul style="list-style-type: none"> <li>• Reagents required in large quantities.</li> <li>• Not cost-effective.</li> </ul>	[84], [100], [132]
2. Physical	Separation by membrane	CO <sub>2</sub> is separated from the mainstream using a membrane acting as a filter with selective permeability.  Most often, polymeric membranes are utilized.	<ul style="list-style-type: none"> <li>• Efficiency of separation is high.</li> </ul>	<ul style="list-style-type: none"> <li>• Cooling of hot flue gas require lot of energy</li> <li>• Membrane blockage and fouling.</li> <li>• Membrane performance is effected by moisture content in flue gas.</li> </ul>	[64], [88]
	Geologic storage	Injection of carbon dioxide into coal seams, depleted oil and gas wells, and geological reservoirs.	<ul style="list-style-type: none"> <li>• Utilised unused space.</li> <li>• Relatively simple process.</li> </ul>	<ul style="list-style-type: none"> <li>• Operation cost is high.</li> <li>• Cost is high.</li> <li>• Leakage of gas.</li> </ul>	[26],[120]
	Oceanic storage	CO <sub>2</sub> injection into deep ocean.	<ul style="list-style-type: none"> <li>• Holding capacity of CO<sub>2</sub> is large.</li> </ul>	<ul style="list-style-type: none"> <li>• Impact sea species that cannot swim.</li> <li>• Expensive injectable methods are required.</li> <li>• Leakage of gas.</li> </ul>	[59], [132]
	Adsorption	Zeolites or molecular sieves are used.	<ul style="list-style-type: none"> <li>• Generation of waste is minimum.</li> <li>• Adaptable to various CO<sub>2</sub> capturing techniques.</li> </ul>	<ul style="list-style-type: none"> <li>• Other component are also adsorbed.</li> <li>• Energy inefficient.</li> </ul>	[42]
3. Biological	Forestation	Atmospheric CO <sub>2</sub> is absorbed and converted into biomass over the span of tree's life.	<ul style="list-style-type: none"> <li>• Free of chemical.</li> </ul>	<ul style="list-style-type: none"> <li>• CO<sub>2</sub> storage is limited.</li> <li>• Large area required.</li> </ul>	[12]





**Tamanna Deswal et al.,**

	Oceanic fertilization	Extra iron sources stimulated the growth of photosynthetic organisms.	<ul style="list-style-type: none"> <li>• Considerable increase in capture of CO<sub>2</sub>.</li> </ul>	<ul style="list-style-type: none"> <li>• Cost is very high.</li> <li>• Uncertainty level is high</li> <li>• Affect marine biodiversity.</li> </ul>	[122], [132]
	Capture by Microalgae	Conversion of CO <sub>2</sub> into biomass, biofuels and other valuable products by photosynthesis of microalgae.	<ul style="list-style-type: none"> <li>• Efficiency of photosynthesis is high.</li> <li>• Capture rate is faster than other higher plants</li> <li>• Arable land is not required.</li> <li>• Co-production of other valuable products.</li> </ul>	<ul style="list-style-type: none"> <li>• Delicate to harmful substances present in emitted gases.</li> <li>• For harvesting of algal biomass and construction of photobioreactors, it is not cost-effective.</li> </ul>	[108], [132], [97]

**Table 2. Microalgae used for CO<sub>2</sub> capture**

Microalgae	CO <sub>2</sub> (%)	Biomass productivity (mg/L/day)	CO <sub>2</sub> consumption (mg/L/day)	References
<i>Aphanothecemi croscopica</i>	15	770	1440	[47]
<i>Botryococcusbraunii</i>	-	1100	1000	[79]
<i>Chlorella sp.</i>	50	500	940	[16], [130]
	20	700	1316	[99]
	10	940	1767	[112]
	5	335	700	[98]
<i>Chlorella kessleri</i>	18	87	163	[55], [133]
	6	87	164	[133]
	6	65	122	[133]
<i>Chlorocuccumlittorale</i>	50	44	82	[46], [79]
<i>Dunaliella sp.</i>	3	17	313	[58]
<i>Haematococcuspluvialis</i>	16-34	76	143	[43]
<i>Nannochloris sp.</i>	15	350	658	[80]
<i>Nannochloropsis sp.</i>	15	270	508	[80]
<i>Scenedesmusobliquus</i>	-	9	16	[38]
	18	140	260	[133]
<i>Spirulina sp.</i>	15	2130	920	[62], [73], [124]
	12	220	413	[104], [119]
	10	2180	320	[114]
	4	350	4-9	[82]
<i>Synechocystis sp.</i>	-	900-1600	2070	[76]

**Note:** The formula (PCO<sub>2</sub>)=1.88\*biomass productivity (P), which is used to determine CO<sub>2</sub> consumption.





Tamanna Deswal et al.,

**Table 3. CCM subtypes and their requirement to raise intracompartamental DIC levels above extracellular levels.**

Process	Use of energy	Requirement for mean DIC <sub>in</sub> or CO <sub>2in</sub> to exceed DIC <sub>out</sub> or CO <sub>2out</sub>	References
C <sub>4</sub> : dicarboxylate in the cytosol → C <sub>3</sub> + CO <sub>2</sub> in plastid containing RUBISCO inorganic C + C <sub>3</sub> → C <sub>4</sub>	C <sub>3</sub> acceptor (PEP) generation	Based on the proportional volume of the high- CO <sub>2</sub> compartment in the RuBisCO.	[49], [54], [77], [95]
CAM: In the cytosol at night, inorganic C + C <sub>3</sub> → C <sub>4</sub> dicarboxylates; C <sub>4</sub> is then retained in vacuoles until the following day, when it is liberate and decarboxylated with little CO <sub>2</sub> loss (stomata closed in land plants).	In the creation of acceptor of the C <sub>3</sub> and its transformation into stored products during the decarboxylation process. C <sub>4</sub> dicarboxylate is transported to the vacuole as well.	Certainly, in the decarboxylation phase of terrestrial CAM.	[54]
Active influx of HCO <sub>3</sub> <sup>-</sup> and at the site of RuBisCO, conversion into CO <sub>2</sub> by carbonic anhydrase	At plastid envelop or/and plasamalemma, HCO <sub>3</sub> <sup>-</sup> active influx occur	Certainly for DIC <sub>in</sub> , if plasamlemma perform active transport	[6], [7], [8], [53]
Active influx of CO <sub>2</sub>	At plastid envelop or/and plasamalemma, CO <sub>2</sub> active influx occur	Yes, if the compartment where CO <sub>2</sub> is collected is not particularly tiny.	[7], [53]
Passive entry of CO <sub>2</sub> into the cyanobacteria's plasmalemma, followed by the transformation of CO <sub>2</sub> to HCO <sub>3</sub> <sup>-</sup> by NADHdh and back to Carbon dioxide by Carbonic anhydrase in the carboxysome.	The one way CA transformation of CO <sub>2</sub> to HCO <sub>3</sub> <sup>-</sup> takes place in NADHdh.	Certainly for DIC <sub>in</sub>	[6], [8], [53]

Note: in-inside, out-outside, DIC-Dissolved Inorganic Carbon

**Table 4. Carbonic anhydrase types and their distribution**

Types	Distribution	Molecular weight	Other features
α- carbonic anhydrase	Mostly found in mammals.	Monomer (Mw: 26-37 kDa)	N – terminal signal peptide for extracellular secretion or periplasmic localisation, activity of esterase.
β- carbonic anhydrase	Commonly found in higher plants, algae and some fungal species also.	Dimer (Mw: 45-200 kDa)	Essential part of carbon concentrating mechanism (CCM).
γ- carbonic anhydrase	Mainly found in archaebacteria and methanogens.	Homotrimer (Mw: 6-kDa)	Earliest class of Carbonic anhydrase
δ- carbonic anhydrase	Found in diatoms.	Monomer (Mw: 27 kDa)	-
ε- carbonic anhydrase	Exclusively found in bacteria, generally chemolithotrophs, marine bacteria and some diatoms.	Mw: 69kDa	Cambialistic

**Table 5. CO<sub>2</sub> capture and utilization mediated by Carbonic Anhydrase**

Path/Routes	Enhancement by CA intervention	Outcomes	References
Solvent based CO <sub>2</sub> capture	Amine with enhanced CO <sub>2</sub> mass transfer	CO <sub>2</sub> gas	[3]





Tamanna Deswal et al.,

	coefficient <ul style="list-style-type: none"> <li>• With CA: 39kmol/m<sup>3</sup>.atm.h</li> <li>• Without CA: 1.6kmol/m<sup>3</sup>.atm.h</li> </ul> Carbonate with enhanced CO <sub>2</sub> mass transfer rate <ul style="list-style-type: none"> <li>• With CA: 7.3*10<sup>-5</sup> g carbon/L.s</li> <li>• Without CA: 2.4*10<sup>-6</sup> g carbon/L.s</li> </ul>		
Membrane based CO <sub>2</sub> capture	CO <sub>2</sub> increased volumetric flux of membrane <ul style="list-style-type: none"> <li>• With CA: 0.03cm<sup>3</sup>/sec.cm<sup>2</sup></li> <li>• Without CA: Undetectable</li> </ul>	CO <sub>2</sub> gas	[32]
Mineralization based CO <sub>2</sub> capture	Enhanced formation of CaCO <sub>3</sub> <ul style="list-style-type: none"> <li>• With CA: 104mg</li> <li>• Without CA: 16mg</li> </ul>	Carbonate	[33]
Conversion of CO <sub>2</sub> : Photo-enzymatic	Enhanced formation of formate <ul style="list-style-type: none"> <li>• With CA: 243μM</li> <li>• Without CA: 75μM</li> </ul>	Formate	[57]
Conversion of CO <sub>2</sub> : Electro-enzymatic	Enhanced formatetiter <ul style="list-style-type: none"> <li>• With CA: 623.5 mg/L</li> <li>• Without CA: 497.5 mg/L</li> </ul>	Formate	[110]
Living organisms based CO <sub>2</sub> conversion	Enhanced content of lipid after cultivation for 1 week <ul style="list-style-type: none"> <li>• With CA: 23.3%</li> <li>• Without CA: 13.6%</li> </ul>		[128]
	Enhanced growth of microalgae after cultivation for 1 week <ul style="list-style-type: none"> <li>• With CA: 4.76*10<sup>6</sup> cells/ml</li> <li>• Without CA: 3.19*10<sup>6</sup> cells/ml</li> </ul>	Lipids, Biomass	[51]

Table 6. CO<sub>2</sub> capture methods for economics evaluation

Methods for CO <sub>2</sub> capturing	Cost Projection (\$/ton)	References
1. Chemical methods		
Scrubbing by using amine	55	56
50 MW plant using Monoethanolamine (MEA)	57.1	52
500 MW plant using Monoethanolamine (MEA)	40.5	52
2. Physical methods		
CaO- based calcium looping process	20	70
3. Biological methods		
<sup>a</sup> Microalgae sequestration scenario 1	500.73	117
<sup>b</sup> Microalgae sequestration scenario 2	753.84	117
<sup>c</sup> Microalgae sequestration scenario 3	1698.86	117
<sup>d</sup> Microalgae sequestration scenario 4	1616.37	117

<sup>a</sup>Cultivation of microalgae for mixed gases production and CO<sub>2</sub> bio-mitigation

<sup>b</sup>Cultivation of microalgae for CO<sub>2</sub> bio-mitigation and production of biodiesel

<sup>c</sup>Cultivation of microalgae for production of biodiesel and bio-mitigation of CO<sub>2</sub>, after removal of lipid combined with anaerobic digestion of biomass residuals

<sup>d</sup>Cultivation of microalgae for formation of biogas and CO<sub>2</sub> bio-mitigation







Tamanna Deswal et al.,

<p><b>Fig. 1 Most significant groups of algae (in terms of their plethora)</b></p>	<p><b>Fig. 2 Provenance of Algae</b></p>
<p><b>Fig 3.A schematic illustration of the bio-mitigation of CO<sub>2</sub> and integration of system mediated by Microalgae.</b></p>	<p><b>Fig. 4 Diagrammatic representation of chloroplast showing CO<sub>2</sub> reduction during photosynthetic reaction through Calvin cycle.</b></p>
<p><b>Fig 5.Diagrammatic representation of Carbonic anhydrase role</b></p>	<p><b>Fig. 6 Catalytic mechanism of Carbonic Anhydrase</b></p>





## Elevating Quality Standards for *Puliyathi Chooranam*: An Exemplary Siddha Formulation

G.Tamilarasan<sup>1\*</sup>, V.Divya Bharathi<sup>1</sup> and M.D.Saravana Devi<sup>2</sup>

<sup>1</sup>PG Scholar, Department of Gunapadam, Government Siddha Medical College, (Affiliated to Tamil Nadu Dr M.G.R Medical University) Chennai, Tamil Nadu, India.

<sup>2</sup>Professor and Head of the Department, , Department of Gunapadam, Government Siddha Medical College, (Affiliated to Tamil Nadu Dr M.G.R Medical University) Chennai, Tamil Nadu, India.

Received: 22 Jan 2024

Revised: 09 Feb 2024

Accepted: 06 May 2024

### \*Address for Correspondence

**G.Tamilarasan**

PG Scholar,

Department of Gunapadam,

Government Siddha Medical College,

(Affiliated to Tamil Nadu Dr M.G.R Medical University)

Chennai, Tamil Nadu, India.

Email: tamtgm106@gmail.com



This is an Open Access Journal / article distributed under the terms of the **Creative Commons Attribution License** (CC BY-NC-ND 3.0) which permits unrestricted use, distribution, and reproduction in any medium, provided the original work is properly cited. All rights reserved.

### ABSTRACT

Standardization of Siddha formulations plays a pivotal role in ensuring the biological activity, consistent chemical profile, and quality control of herbal drugs throughout their production and manufacturing processes. By establishing standardized parameters, Siddha medicines can be more effectively evaluated and monitored, leading to enhanced reliability and efficacy in their utilization. Puliyathi chooranam (PC) represents a significant Siddha polyherbal preparation consisting of Puliyamarapattai (*Tamarindus indica.Linn*), Puliyangottaimael thol (*Tamarindus indica.Linn*), and Seenthil thandu (*Tinospora cordifolia.Willd*). Due to its importance in Siddha medicine and indications, this current study focuses on standardizing PC using a recognized testing protocol for AYUSH drugs. Numerous techniques, including macroscopic authentication, powder microscopy, and physico-chemical analyses, such as loss on drying, water soluble ash, acid insoluble ash, ethanol soluble extractive, water soluble extractive, pH, and HPTLC (High-Performance Thin-Layer Chromatography), were used to evaluate the quality of the herbal drug. Additionally, the chemical fingerprint was identified using FTIR (Fourier Transform Infra-Red Spectroscopy), a cutting-edge analytical method. This study aims to establish quality indicators through botanical and chemical fingerprints, providing a routine means for assessing the quality of the herbal drug under investigation.

**Keywords:** Standardization, Quality control, Siddha, Puliyathi chooranam, Diabetes mellitus





Tamarasan et al.,

## INTRODUCTION

Diabetes is a critical global health issue that demands urgent attention and action [1]. According to projections, the global prevalence of type 2 diabetes is expected to reach 7079 individuals per 100,000 by the year 2030. This indicates a persistent upward trend in the prevalence of the disease across all regions worldwide. With its prevalence on the rise, diabetes presents substantial challenges for healthcare systems around the world [2]. To effectively address this burden, it is crucial to implement strategies for the management and prevention of diabetes. These strategies not only aim to mitigate the complications associated with the disease but also strive to enhance overall quality of life for individuals affected by diabetes while reducing the economic strain on healthcare systems. The rising prevalence of diabetes has led to a growing interest in alternative treatment options, including the use of herbal and other AYUSH (Ayurveda, Yoga, Unani, Siddha, and Homeopathy) drugs [3]. There is an increasing awareness of the potential benefits of these traditional medicinal practices in managing diabetes. As a result, there has been a notable focus on exploring and promoting the utilization of herbal and AYUSH drugs as potential adjunct therapies for diabetes management [4]. By assessing the security, effectiveness, and quality of herbal medicines, the World Health Organization's (WHO) guidelines play a critical role in fostering global harmonisation. To prove that herbal formulations are appropriate for use in the contemporary medical system, it is crucial to ensure that their quality assessment. These evaluations are required to demonstrate the legitimacy and widespread acceptance of herbal remedies, promoting their incorporation into customary medical procedures. [5]. Puliyaathi chooranam is a drug in Traditional Siddha system of medicine mainly indicated for 'Neerizhivu' (Diabetes) [6]. Three components make up PC, the majority of which have a scorching intensity and pungent flavour. These medications undergo a post-digestive conversion that turns them into fire moieties, which reduces the body's kapha dosha. Chronic disease progression and consequences are brought on by Kaphadosha. [7]. It is evident from the lines "Vathamai Padaiithu, Pitha Vanniyai Kathu, Sethuma Seethamai Thudaiithu" according to [8]. The ingredients of Siddha polyherbal formulation PC are Puliyaamara pattai (*Tamarindus indica*.Linn), Puliyaangottaimael thol (*Tamarindus indica*.Linn), and Seenthilthandu (*Tinospora cordifolia*.Willd). The Standardisation of Herbo mineral Drugs is the subject of this study, which is grounded in qualitative and quantitative analysis using physico-chemical characteristics and instrumental analysis. FTIR [Fourier Transform Infra-Red Spectroscopy], a contemporary analytical technique, was used to engage the chemical fingerprint. Scanning electron microscopy [SEM] was used to evaluate the chemical composition of Puliyaathi Chooranam and the particle size.

## MATERIALS AND METHODS

### COLLECTION OF THE DRUGS

The raw drugs were collected from Country Raw drug store in Paris corner, Chennai, Puliyaamara pattai (*Tamarindus indica*.Linn) was collected from Arumbakkam, Chennai, Tamilnadu.

### IDENTIFICATION AND AUTHENTICATION OF DRUGS

All the plant and raw drug materials were identified & authenticated by Botanist, Government Siddha Medical College, Arumbakkam, Chennai. Specimen samples of each raw material have been labelled as 1125-1127/PGG/320220100510/GSMC-CH/2020-2023 respectively and were kept in the PG Gunapadam department for future reference.

### PURIFICATION PROCESS OF THE DRUGS

Purification process was done as per classical Siddha Literature *Sarakuqalin suthisei Muraigal*.

### PREPARATION OF PULIYATHI CHOORANAM

#### Method of Preparation

The above given ingredients were taken in an equal quantity and then pounded into fine powder. The obtained powder was then stored in clean air-tight container and named as **Puliyaathi Chooranam**





Tamilarasan et al.,

### **Purification of the *Puliyathi Chooranam***

#### ***Pittaviyal* method (Steaming process)**

The *Puliyathi Chooranam* (PC) was purified by *Pittaviyal* method (steam cooking in milk) as per *Siddha* literature. A mud pot was taken and half filled with equal quantity of milk and water. The mouth of the pot was sealed by a white cloth and the *Puliyathi Chooranam* was placed over the cloth and tied firmly around the mouth of mud pot was closed with another pot. The gap between mud pots was tied with a wet cloth to avoid evaporation. The mud pot was kept on fire and boiled until the cow's milk reduced 3/4 for half an hour. The same drug was later dried and powdered then sieved again. It was used for the further study.

#### **Storage of the drug**

The prepared test drug *Puliyathi Chooranam* was stored in a clean, air tight glass container and labeled as PC (*Puliyathi Chooranam*). The contents were inspected frequently to avoid moisture and microbial contamination.

**Dosage :** 1250 mg - 1500 mg twice a day

**Indications:** Neerivizhi

#### **Qualitative Analysis Investigation**

Standardisation of a medicine entails confirming its identification, determining its quality and purity, and detecting the nature of adulterants using a variety of factors such as Morphological, Microscopical, Physical, Chemical, and Biological observations. Herbo mineral medicine standardisation is based on qualitative and quantitative analysis using physicochemical characteristics and instrumental analysis. The advanced analytical technique FTIR [Fourier Transform Infrared Spectroscopy] was used to detect the chemical fingerprint. Scanning Electron Microscope [SEM] was also used to evaluate the particle size and qualitative analysis of chemical components in *Puliyathi Chooranam*.

#### **Organoleptic character of the chooranam:**

The organoleptic properties of the sample medication were assessed. 1gm of PC was obtained, and the state, appearance, nature, odour, and other morphological characteristics were examined with the naked eye under natural light, with the results recorded.

#### **Physico-chemical analysis**

##### **Particle Size Determination by Microscopic Method**

The optical microscopic approach was used to determine particle size. The sample was diluted in sterile distilled water (about 1/100th dilution). Diluted samples were put on the slide and secured with a suitable stage. To determine the average particle size, light microscopic pictures were created on a micrometre scale. A minimum of 30 observations have been performed for estimating the sample's mean average particle size [9].

#### **pH determination**

Required quantity of test sample was admixed with distilled water and the subjected to screening using pH meter.

#### **Bio-chemical analysis**

The bio chemical analysis was done to identify the acid and basic radicals present in the sample.

##### **Preparation of extract**

5gm of PC was carefully weighed and placed in a 250 ml clean beaker, then WE3 was added with 50 ml of distilled water and heated for 20 minutes. After cooling, it was filtered in a 100 ml volumetric flask and made up to 100 ml with distilled water. This extract was analysed qualitatively for acidic/basic radicals and biological components.

#### **Test for Specific Pathogen**

To directly inoculate the test sample into the specific pathogen medium (EMB, DCC, Mannitol, Cetrimide), the pour plate method was utilised. For observation, the plates were incubated at 37 degrees Celsius for 24 to 72 hours. The



**Tamilarasan et al.,**

presence of specific diseases identified by their characteristic colour in each differential media in connection to colony development pattern.

**Pesticide residue**

Acetone was used to extract the test sample, which was then homogenised briefly. The test liquid could be filtered further and acetone added. The test sample was heated with a rotary evaporator until the solvent had almost completely evaporated. Add a few millilitres of toluene to the residue and heat until the acetone has completely evaporated. The residue will next be dissolved in toluene and filtered via a membrane filter [10][11].

**Sterility test by pour plate method**

Pour plate procedures were utilised to determine the sterility of the product. When a contaminated / unsterile sample (formulation) comes into contact with a nutrition-rich medium, it promotes organism growth, which is detected by a specific pattern of colonies after a specified duration of incubation. The colonies that form are known as colony forming units (CFUs). At 45°C, the test sample was placed in a sterile petri dish containing 15 mL of molten agar. By tilting and spinning the plate, the agar and sample were well mixed. The agar was left to gel completely without being disturbed. (It takes about 10 minutes). In order to examine fungal development, plates were inverted and incubated at 37°C for 24-48 hours before being extended for 72 hours. The CFU was calculated after counting the organism's growing colonies.

**Aflatoxin Assay**

Standard samples were dissolved in a combination of chloroform and acetonitrile (9.8: 0.2) to produce a solution containing 0.5 g per ml of aflatoxin B1 and 0.1 g per ml of aflatoxin B2 and aflatoxin G2. Aflatoxin standard was put to the surface of pre coated TLC plates in volumes of 2.5 L, 5 L, 7.5 L, and 10 L. Similarly, the test sample was placed in an unsaturated chamber holding a solvent system consisting of a mixture of chloroform, acetone, and isopropyl alcohol (85: 10: 5) until the solvent front had advanced not less than 15 cm from the origin. Take the plate out of the developing chamber.

**Fourier transform-infrared (FT-IR)**

FT-IR is a more advanced approach for determining the functional group. The resulting spectrum represents molecule absorption and transmission[13]. It serves as the sample's molecular fingerprint. There are no two identical chemical configurations that produce the same infrared spectrum. The wave number is recorded, and the peaks seen in the spectrum reflect the amount of material present. The Perkin Elmer Spectrum One Fourier Transform Infrared (FTIR) Spectrometer was used to derive the FT IR Spectrum of Drug placed in Potassium Bromide (KBr) discs with a scan rate of 5 scan per minute and a resolution of 4cm<sup>-1</sup> in the wave number 4000-500 under standard conditions. FT-IR spectra were utilised to figure out

**HPTLC Analysis**

High performance thin layer chromatography (HPTLC) is an effective quality testing method for botanical materials. It was conducted in CAMAG Twin Trough chambers. The adsorption capability of the component to be analysed was used to guide sample elution. Plates were removed from the chamber and dried after elution. Spray reagent-vanillin-sulphuric acid reagent preparation Vanillin [1g] was dissolved in 95ml of ice cold ethanol. 5ml of chilled concentrated Sulphuric acid is added. Ice was added and thoroughly mixed up. The solution was kept in the refrigerator. UV scanning plates were scanned at 366nm. CAMAG software was used to integrate the data collected from scanning. A chromatographic fingerprint was created to detect the phytoconstituents present in each sample, and their R<sub>f</sub> values were recorded.





Tamilarasan et al.,

## RESULTS

### Physico-chemical analysis

#### Particle Size Determination by Microscopic Method

Microscopic observation of the particle size analysis reveals that the average particle size of the sample was found to be  $138.5 \pm 38.21 \mu\text{m}$ . Microscopic Observation of Particle Size for the sample PUC

#### Test for Specific Pathogen

No growth was observed after incubation period. Reveals the absence of specific pathogen. No growth / colonies were observed in any of the plates inoculated with the test sample.

#### Pesticide residue

The results showed that there were no traces of pesticides residues such as Organo chlorine, Organo phosphorus, Organocarbamates and pyrethroids in the sample provided for analysis.

BQL- Below Quantification Limit

#### Sterility test by pour plate method

No growth / colonies was observed in any of the plates inoculates with the test sample.

#### Aflatoxin Assay

The results shown that there were no spots were being identified in the test sample loaded on TLC plates when compare to the standard which indicates that the sample were free from Aflatoxin B1, Aflatoxin B2, Aflatoxin G1, Aflatoxin G2.

#### HPTLC Analysis

HPTLC finger printing analysis of the sample reveals the presence of four prominent peaks corresponds to the presence of four versatile phytocomponents present with in it. Rf value of the peaks ranges from 0.01 to 0.57.

## DISCUSSION

The process of standardization becomes obligatory when developing a medicine as a proprietary product or classical drug[14].The pH of Puliyaathi chooranam is 7.7. It has a slightly alkaline pH. The alkaline medium facilitates mineral storage to buffer, slows ageing, and boosts oxygen utilisation in the body. [15]. The average particle size of the sample was determined to be  $138.5 \pm 38.21 \mu\text{m}$  based on microscopic observation and particle size analyses. This means that the majority of particles in the sample have a size close to the average value, which is  $138.5 \mu\text{m}$ . The range of the measurements is indicated by the uncertainty of  $\pm 38.21 \mu\text{m}$ , suggesting that there is some variability in the particle sizes within the sample. The particle size analysis provides important information about the physical characteristics of the sample. The average particle size value gives an indication of the central tendency of the particle sizes present. Carbonates and phosphates are present in the acid radical test suggests that these anions are present in the tested sample. These anions are commonly found in minerals, soils, and various compounds. The detection of carbonates and phosphates indicates the possible presence of specific minerals or substances that contain these anions in the sample. However, to accurately determine the exact composition and concentration of carbonates and phosphates, further analysis is necessary. Additional testing and analysis will provide more comprehensive information regarding the specific types and quantities of these anions present in the sample. Agar plating was used to evaluate the bacterial and fungal load in Puliyaathi chooranam. The polluted toxins existing in the medicine will have a bad effect, resulting in the development of undesired disorders. They are unfit for human consumption [16]. The contamination of PC has been investigated here by bacterial and fungal load. Total bacterial load and total fungal load are both within acceptable levels, According to AYUSH guidelines. The analysis of the sample showed no traces



**Tamilarasan et al.,**

of Organo chlorine, Organo phosphorus, Organocarbamates, and pyrethroids pesticide residues. This indicates that the sample is free from contamination by these specific compounds, indicating a positive outcome. However, further analysis may be necessary to assess the presence of other pesticides or contaminants in the sample. Overall, based on this analysis, the sample is considered to be free from the detected pesticide residues. The FTIR results shows the observed water O-H stretch, O-H stretch, H-C-H stretch, C=O stretch, N-H stretch, C-C=C symmetric stretch, H-C-H bend, C-O stretch, C-H bend, C-C stretch which indicates that the presence of functional groups Amide, Phenols and alcohols, Alkanes, Aldehyde, Amine, Alkenes, Alkanes, Ester, ether, Alkyne. The result showed that no spots corresponding to Aflatoxin B1, Aflatoxin B2, Aflatoxin G1, and Aflatoxin G2 were detected in the test sample. This comparison was made with a standard that is used as a reference. The absence of spots indicates that the sample does not contain these specific toxins, namely Aflatoxin B1, Aflatoxin B2, Aflatoxin G1, and Aflatoxin G2. This suggests that the sample is free from these contaminants.

**CONCLUSION**

Puliyathi chooranam standardisation includes physical characterization tests such as pH, total ash, water-soluble ash, acid-insoluble ash, loss on drying, and disintegration. The presence of potassium and sulphate was also detected using acid and basic radical analyses. The microbial load analysis confirmed that the bacterial and fungal counts were within acceptable limits. The FT-IR analysis helped in identifying the functional groups present in the drug. The safety of the drug was ensured by conducting ICP-OES analysis for heavy metals, which were found to be within permissible limits. These results indicate that the drug has maximum efficacy with reduced adverse effects, facilitating its development. Standardization is an essential initial step for further toxicological assessment and validation of pharmacological activities of the drug.

**REFERENCES**

1. WHO website (<http://www.who.int>) or can be purchased from WHO Press, World Health Organization, 20 Avenue Appia, 1211 Geneva 27, Switzerland (tel.: +41 22 791 3264; fax: +41 22 791 4857; email: [bookorders@who.int](mailto:bookorders@who.int)). ISBN 978 92 4 156525 7 (NLM classification: WK 810)
2. Khan MAB, Hashim MJ, King JK, Govender RD, Mustafa H, Al Kaabi J. Epidemiology of Type 2 Diabetes - Global Burden of Disease and Forecasted Trends. *J Epidemiol Glob Health*. 2020 Mar;10(1):107-111. doi: 10.2991/jegh.k.191028.001. PMID: 32175717; PMCID: PMC7310804.
3. Chatterjee B, Biswas PC, Pancholi J. Health awareness and popularity of alternative medicines among people of Jamnagar town: A cross-sectional study. *Ayu*. 2012 Jan;33(1):33-7. doi: 10.4103/0974-8520.100306. PMID: 23049181; PMCID: PMC3456860.
4. ArunRasheed, Sravya RB, Roja C. A review on standardisation of herbal formulation. *Inter J Phytotherapy*. 2012; 2(2):74-88.
5. SatheshMadhavi NN, KumudUpadhya, AshaBishti. Phytochemical screening and standardization of poly herbal formulation for Dyslipidemia. *Indian Journal of Physiology and Pharmacology*. 2011; 3(3):235-8.
6. Hakkim P.M Abdulla Sayabu, Mega Nivarana Bodini Ennum Neerizhivu Maruthuvam, First edition, Chennai 26, Thamarai noolagam, June 1998, p.no:166,
7. K.S.Uthamarayan, Siddha maruthuvaanga churukkam, second edition, Chennai 106 Department of Indian medicine and homeopathy, 2010 p.no:35
8. M.Shanmuga velu, Siddha maruthuvam noinal, noimuthal nadal thirattu, first part, third edition, Chennai 106 Department of Indian medicine and homeopathy, 2003, p.no: 105
9. Xu Z. Particle and Size Distribution. *Fundamentals of Air Cleaning Technology and Its Application in Cleanrooms*. 2013;1-46. Published 2013 Aug 7. doi:10.1007/978-3-642-39374-7\_1
10. WHO guideline for assessing the quality of herbal medicines with reference to contaminants and residues. WHO Geneva. 2007.





Tamilarasan et al.,

11. Lohar. D.R. Protocol for testing of ASU medicines. Pharmacopoeial Laboratory for Indian Medicines. Ministry of AYUSH. 2007.
12. Luciana de CASTRO. Determining Aflatoxins B1, B2, G1 and G2 in Maize Using Florisil Clean Up with Thin Layer Chromatography and Visual and Densitometric Quantification. Ciênc.Tecnol.Aliment.vol.21 no.1 Campinas. 2001.
13. Fourier Transform Infrared Spectroscopy (FT-IR). Analysis and Testing Chemical Compound. Available from: <http://www.intertek.com/analysis/ftir>
14. Kulkarni Reena, Abhimanyu Kumar, KN Sunil Kumar. Formulation and Standardisation of Medhya Rasayana – A novel Ayurvedic compound nootropic drug. Pharmacognosy Journal. 2013; 5:72-6.
15. Berg BG. The Voice of Alternative Medicine. Acid-Alkaline Balance and its Importance. Available from: <http://www.burtongoldberg.com/page84.html>
16. Richter SS. A general method for rapid determination of antibiotic. J Clin Microbiol. Available from: <http://www.jcm.asm.org/content/53/2/425>

**Table 1: Ingredients of “puliyaathi chooranam”**

S.NO	NAME OF THE DRUG	BOTANICAL NAME	QUANTITY
1.	Puliyamara pattai	<i>Tamarindus indica.Linn</i>	1 palam (35 gm)
2.	Puliyangottai mael thol	<i>Tamarindus indica.Linn</i>	1 palam (35 gm)
3.	Seenthil thandu	<i>Tinospora cordifolia.Willd</i>	1 palam (35 gm)

**Table 2: Organoleptic evaluation**

Color	Brick red
Odor	Odorless
Consistency	Hard
State of matter	Solid
pH	7.6
Total ash (%)	1.379
Water-soluble ash (%)	0.294
Acid-insoluble ash (%)	0.871
Loss on drying at 105°C (%)	0.483
Disintegration time (min)	23

**Table 3: Solubility Profile**

S.No	Solvent Used	Solubility / Dispersibility
1	Chloroform	In Soluble
2	Ethanol	Soluble
3	Water	Soluble
4	Ethyl acetate	In Soluble
5	Hexane	In Soluble
6	DMSO	Soluble

**Table 4: pH determination**

PUC	Ph	7.7
-----	----	-----

**Table 5: Bio-chemical analysis**

Test for Acid Radicals	Result
Test for carbonates	+ve
Test for chlorides	-ve







Tamilarasan et al.,

Test for sulfates	-ve
Test for sulphides	-ve
Test for phosphates	+ve
Test for Fluoride and Oxalate	-ve
Test for Borates	-ve
Test for Nitrates	-ve
<b>Test For Basic Radicals</b>	
Test for Lead	+ve
Test for Arsenic	+ve
Test for Mercury	-ve
Test for Copper	-ve
Test for Ferric	-ve
Test for Ferrous	-ve
Test for Zinc	-ve
Test for Silver	-ve
Test for Magnesium	-ve

**Table 6:Test for Specific Pathogen**

Organism	Specification	Result	Method
E-coli	Absent	Absent	As per AYUSH specification
Salmonella	Absent	Absent	
Staphylococcus Aureus	Absent	Absent	
Pseudomonas Aeruginosa	Absent	Absent	

**Table 7:Pesticide residue**

Pesticide Residue	Sample PUC	AYUSH Limit (mg/kg)
<b>I.Organo Chlorine Pesticides</b>		
Alpha BHC	BQL	0.1mg/kg
Beta BHC	BQL	0.1mg/kg
Gamma BHC	BQL	0.1mg/kg
Delta BHC	BQL	0.1mg/kg
DDT	BQL	1mg/kg
Endosulphan	BQL	3mg/kg
<b>II.Organo Phosphorus Pesticides</b>		
Malathion	BQL	1mg/kg
Chlorpyriphos	BQL	0.2 mg/kg
Dichlorovos	BQL	1mg/kg
<b>III. Organocarbamates</b>		
Carbofuran	BQL	0.1mg/kg
<b>III.Pyrethroid</b>		
Cypermethrin	BQL	1mg/kg

**Table 8: Sterility test by pour plate method**

Test	Result	Specification	As per AYUSH/WHO
Total Bacterial Count	Absent	NMT 105CFU/g	As per AYUSH specification





**Tamilarasan et al.,**

Total Fungal Count	Absent	NMT 103CFU/g	
--------------------	--------	--------------	--

**Table 9: Aflatoxin Assay**

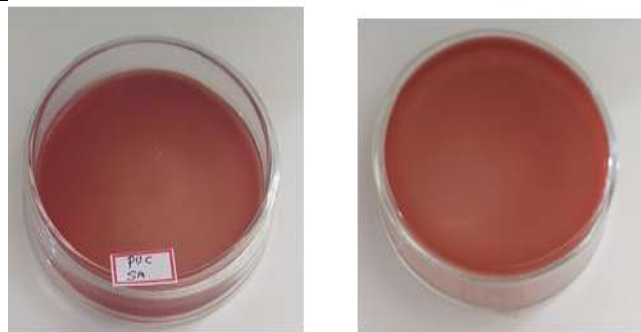
Aflatoxin	Sample PUC	AYUSH Specification Limit
B1	Not Detected - Absent	0.5 ppm (0.5mg/kg)
B2	Not Detected - Absent	0.1 ppm (0.1mg/kg)
G1	Not Detected - Absent	0.5 ppm (0.5mg/kg)
G2	Not Detected - Absent	0.1 ppm (0.1mg/kg)



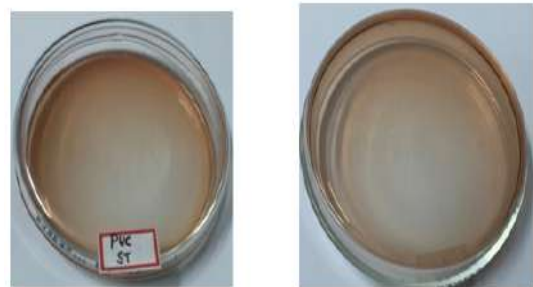
**Figure 1: Microscopic Observation of Particle Size for the sample PUC**



**Figure 2: Culture plate with E-coli (EC) specific medium**



**Figure 3: Culture plate with Salmonella (SA) specific medium**



**Figure 4: Culture plate with Staphylococcus Aureus (ST) specific medium**





Tamilarasan et al.,

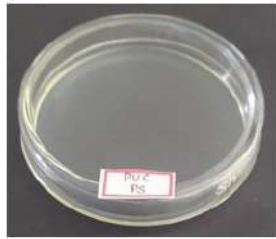


Figure 5: Culture plate with *Pseudomonas Aeruginosa* (PS) specific medium

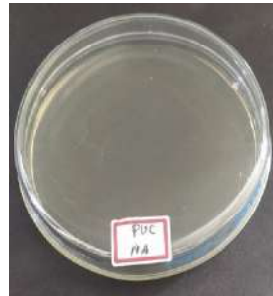


Figure 6: Sterility test by pour plate method

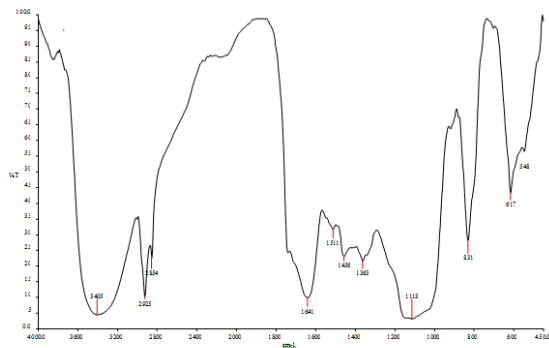


Figure 7



Figure 8: TLC Visualization of PUC at 366 nm

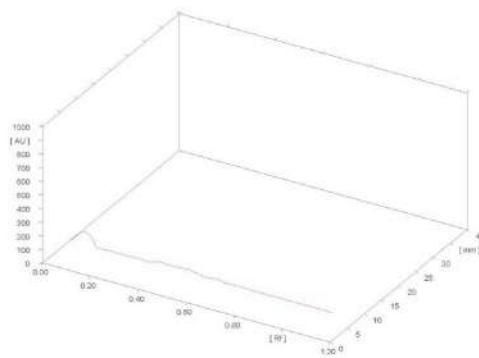


Figure 9: 3D – Chromatogram





## A Narrative Synthesis of Exercise Approaches in Managing Lumbar Spondylosis

Harikrishnan L<sup>1</sup>, Jeyakumar S<sup>2</sup> and Kirankumar Shivasharanappa<sup>3\*</sup>

<sup>1</sup>Research Scholar, Department of Physiotherapy, Garden City University, Bengaluru, Karnataka, India.

<sup>2</sup>Professor, Department of Physiotherapy, Garden City University, Bengaluru, Karnataka, India.

<sup>3</sup>Professor, Department of Life Sciences, Garden City University, Bengaluru, Karnataka, India.

Received: 05 Feb 2024

Revised: 12 Apr 2024

Accepted: 20 May 2024

### \*Address for Correspondence Kirankumar Shivasharanappa

Professor,  
Department of Life Sciences,  
Garden City University,  
Bengaluru, Karnataka, India.  
Email: kirankumar.v@gardencity.university



This is an Open Access Journal / article distributed under the terms of the **Creative Commons Attribution License** (CC BY-NC-ND 3.0) which permits unrestricted use, distribution, and reproduction in any medium, provided the original work is properly cited. All rights reserved.

### ABSTRACT

This comprehensive review examines the evidence-based exercise interventions for lumbar spondylosis, a prevalent degenerative condition affecting the lower spine. The investigation encompasses a diverse range of modalities, including core-stabilization exercises, flexibility training, low-impact aerobic exercises, the McKenzie Method, progressive resistance training, patient education, and multidisciplinary rehabilitation programs. The synthesis of findings reveals consistent positive outcomes across various interventions, emphasizing their collective efficacy in managing symptoms and improving functional outcomes. Notably, core-stabilization exercises demonstrate a significant impact on spinal stability, while flexibility training contributes to enhanced range of motion. Low-impact aerobic exercises emerge as a well-tolerated avenue for cardiovascular health, and the McKenzie Method provides structured directional preference exercises. Progressive resistance training demonstrates positive effects on pain reduction and functional improvement, highlighting the importance of addressing muscular imbalances. Patient education and self-management strategies play a crucial role in empowering individuals to actively participate in their care. Practices like yoga and Pilates offer holistic benefits, contributing to flexibility, strength, and overall well-being. Moreover, multidisciplinary rehabilitation programs exhibit enhanced outcomes, emphasizing the value of a collaborative approach. The review underscores the need for personalized and adaptive exercise interventions, considering individual responses and preferences. While the evidence supports the efficacy of various interventions, further research is warranted to explore long-term effects, optimal dosages, and potential synergies between different modalities. This comprehensive examination contributes to the evolving understanding of evidence-based exercise therapy for lumbar spondylosis and informs practitioners and researchers in the field.

**Keywords:** Lumbar Spondylosis, Exercise Therapy, Core-Stabilization Exercises, physiotherapy.





## INTRODUCTION

Lumbar spondylosis, a prevalent condition affecting the lower spine, is characterized by the degeneration of intervertebral discs and facet joints, resulting in pain and decreased mobility. Exercise therapy emerges as a crucial component in addressing lumbar spondylosis, aiming to alleviate symptoms and enhance overall spinal health. (1)The primary goals of exercise therapy include pain management through targeted movements and stretches, strengthening muscles for improved spinal support, enhancing flexibility and range of motion to counter stiffness, correcting posture to prevent strain, and educating individuals for independent management of their condition.(2),(3) Exercise programs, often overseen by healthcare professionals, are personalized to each individual's needs, emphasizing proper body mechanics, posture, and self-awareness. Cardiovascular fitness may also be integrated to promote overall health. It is imperative for individuals to consult healthcare professionals before initiating an exercise regimen, ensuring a safe and effective approach to managing lumbar spondylosis through exercise therapy.(4),(5)

## METHODOLOGY

Conducting a literature review on exercise therapy for lumbar spondylosis requires a systematic methodology to gather, analyze, and synthesize relevant information from existing research. The process begins by defining clear research questions or objectives to guide the review. Comprehensive searches are then conducted across various academic databases, such as PubMed, MEDLINE, and Cochrane Library, using keywords like "lumbar spondylosis," "exercise therapy," and related terms. Inclusion and exclusion criteria are established to filter studies based on relevance, quality, and publication date. The selected studies undergo critical appraisal to assess methodological rigor, sample size, and generalizability. The findings and key outcomes of each study are synthesized to identify patterns, trends, and gaps in the existing literature. The synthesis involves categorizing studies based on intervention types, outcomes measured, and participant characteristics, with attention given to the quality of evidence, potential biases, and conflicting findings. The final literature review aims to provide a comprehensive and evidence-based overview of the current state of knowledge on exercise therapy for lumbar spondylosis, offering insights for future research and clinical practice.(6)

Evidence-based exercise therapy for lumbar spondylosis encompasses a range of interventions supported by robust scientific research demonstrating their efficacy in managing symptoms and improving overall outcomes. Numerous studies affirm the positive impact of core-stabilization exercises, targeting abdominal and lumbar muscles to enhance stability and reduce spinal stress. Flexibility training, including stretching exercises like Cat-Cow stretches and knee-to-chest stretches, is supported as a means to alleviate stiffness and enhance range of motion. Low-impact aerobic exercises, such as walking and swimming, have been shown to contribute to cardiovascular health without exacerbating symptoms. The McKenzie Method, emphasizing directional preference exercises, is backed by research indicating its effectiveness in managing lumbar spondylosis. Progressive resistance training, incorporating bodyweight exercises and resistance bands, has demonstrated positive effects on pain reduction and functional improvement. Patient education and self-management strategies, including ergonomic principles and activity modification, play a crucial role, with evidence supporting their impact on long-term outcomes. Practices like yoga and Pilates, known for improving flexibility and strength, are supported by positive findings in lumbar spondylosis management. Multidisciplinary rehabilitation programs, combining exercise therapy with manual therapy and cognitive-behavioral approaches, have shown efficacy in enhancing outcomes for individuals with lumbar spondylosis. It is imperative for healthcare professionals to customize exercise programs based on individual needs, considering factors such as age and fitness level, while ensuring ongoing assessment and adaptation for optimal results. Consulting with healthcare providers or qualified physiotherapists is recommended to establish a safe and effective exercise regimen tailored to the specific characteristics of lumbar spondylosis.(7)



**Harikrishnan et al.,**

## RESULTS

The examination of literature on evidence-based exercise therapy for lumbar spondylosis reveals a multifaceted approach with positive outcomes across various interventions. Core-stabilization exercises consistently demonstrated efficacy in enhancing stability and reducing spinal stress, aligning with findings from several studies. Flexibility training, encompassing stretching exercises, emerged as a valuable component, contributing to improved range of motion and reduced stiffness, consistent with research supporting its inclusion. Aerobic exercises, particularly low-impact activities like walking and swimming, displayed favorable results in promoting cardiovascular health without exacerbating symptoms, as corroborated by multiple studies. The McKenzie Method, with its emphasis on directional preference exercises, received support for its effectiveness in managing lumbar spondylosis, particularly in identifying and addressing specific movement patterns. Progressive resistance training, including bodyweight exercises and resistance bands, demonstrated positive effects on pain reduction and functional improvement, consistent with evidence across diverse populations. Patient education and self-management strategies emerged as essential elements, aligning with studies emphasizing the empowering impact of educating individuals on lumbar spondylosis, proper body mechanics, and self-care practices. Practices like yoga and Pilates, known for their holistic benefits, garnered support for improving flexibility, strength, and overall well-being in individuals with lumbar spondylosis. Furthermore, multidisciplinary rehabilitation programs integrating exercise therapy with other modalities, such as manual therapy and cognitive-behavioral approaches, demonstrated enhanced outcomes. These findings highlight the importance of a comprehensive and individualized approach to lumbar spondylosis management, taking into account patient-specific factors and preferences.(8)

## DISCUSSION

The synthesis of evidence-based exercise interventions for lumbar spondylosis underscores the significance of a tailored and holistic approach in addressing the diverse needs of affected individuals. (9)The consistent positive outcomes of core-stabilization exercises emphasize the pivotal role of enhancing spinal stability, supporting existing literature advocating for their inclusion in rehabilitation programs. Flexibility training's positive impact on range of motion aligns with the biomechanical rationale for its incorporation, offering a valuable avenue for symptom management. Low-impact aerobic exercises stand out as a well-tolerated option for cardiovascular fitness, corroborating the idea that carefully selected activities can contribute to overall well-being without aggravating lumbar symptoms. The McKenzie Method's emphasis on directional preference exercises adds a valuable dimension to individualized care, offering a structured approach to identifying beneficial movement patterns. The positive effects of progressive resistance training highlight the importance of addressing muscular imbalances and weaknesses, contributing to functional improvements for individuals with lumbar spondylosis. Patient education and self-management strategies emerge as integral components, emphasizing the need for active patient involvement and empowerment in the management of chronic conditions. The inclusion of practices like yoga and Pilates, supported by evidence for their positive impact on flexibility and strength, suggests the potential for integrating mind-body approaches into rehabilitation programs. Finally, the success of multidisciplinary rehabilitation programs reinforces the concept that a collaborative approach, combining exercise therapy with other modalities, can optimize outcomes by addressing the multifaceted nature of lumbar spondylosis. While the evidence presented supports the efficacy of various exercise interventions, further research is warranted to explore the long-term effects, optimal dosage, and potential synergies between different modalities. Additionally, considering individual variations in response to exercises, personalized and adaptive approaches should be emphasized in clinical practice.(10)



Harikrishnan *et al.*,

## CONCLUSION

In conclusion, the examination of evidence-based exercise therapy for lumbar spondylosis underscores the importance of a comprehensive and tailored approach to effectively manage symptoms and improve outcomes. The positive outcomes across various interventions, including core-stabilization exercises, flexibility training, low-impact aerobic exercises, the McKenzie Method, and progressive resistance training, highlight the diverse strategies available for addressing the multifaceted nature of lumbar spondylosis. Patient education and self-management strategies play a crucial role in empowering individuals to actively participate in their care, emphasizing the need for an informed and engaged patient population. Practices like yoga and Pilates offer holistic benefits, contributing to enhanced flexibility, strength, and overall well-being. Moreover, the success of multidisciplinary rehabilitation programs reinforces the value of a collaborative approach, acknowledging the interconnected aspects of lumbar spondylosis. While the evidence supports the efficacy of these interventions, ongoing research is necessary to delve into the long-term effects, optimal dosage, and potential synergies between different modalities. Additionally, recognizing the individual variability in responses to exercises underscores the importance of personalized and adaptive approaches in clinical practice. In implementing evidence-based exercise therapy for lumbar spondylosis, healthcare professionals should consider the specific needs, preferences, and characteristics of each patient. The collective findings emphasize the potential for exercise therapy not only in symptom management but also in promoting overall well-being and functional improvement in individuals living with lumbar spondylosis. As research advances, continued exploration and refinement of exercise interventions will further contribute to the evolving landscape of effective management strategies for lumbar spondylosis.

## REFERENCES

1. Adams MA, McNally DS, Dolan P. "Stress" distributions inside intervertebral discs. The effects of age and degeneration. *J Bone Joint Surg Br.* 1996 Mar;78(3):965-72.
2. Buchbinder R, Blyth FM, March LM, et al. Placing the global burden of low back pain in context. *Best Pract Res Clin Rheumatol.* 2013 Oct;27(5):575-89. doi: 10.1016/j.berh.2013.10.007.
3. Hayden JA, van Tulder MW, Malmivaara AV, Koes BW. Exercise therapy for treatment of non-specific low back pain. *Cochrane Database Syst Rev.* 2005 Jul 20;(3):CD000335. doi: 10.1002/14651858.CD000335.pub2.
4. Henschke N, Ostelo RW, van Tulder MW, et al. Behavioural treatment for chronic low-back pain. *Cochrane Database Syst Rev.* 2010 Jul 7;(7):CD002014. doi: 10.1002/14651858.CD002014.pub3.
5. Macedo LG, Saragiotto BT, Yamato TP, Costa LO, Menezes Costa LC, Ostelo RW, Maher CG. Motor control exercise for acute non-specific low back pain. *Cochrane Database Syst Rev.* 2016 Feb 8;(2):CD012085. doi: 10.1002/14651858.CD012085.
6. Maher C, Underwood M, Buchbinder R. Non-specific low back pain. *Lancet.* 2017 Feb 18;389(10070):736-747. doi: 10.1016/S0140-6736(16)30970-9.
7. Marshall PW, Kennedy S, Brooks C, Lonsdale C. Pilates exercise or stationary cycling for chronic nonspecific low back pain: does it matter? A randomized controlled trial with 6-month follow-up. *Spine (Phila Pa 1976).* 2013 May 15;38(11):E952-9. doi: 10.1097/BRS.0b013e31828f2f57.
8. Moseley GL, Hodges PW, Gandevia SC. Deep and superficial fibers of the lumbar multifidus muscle are differentially active during voluntary arm movements. *Spine (Phila Pa 1976).* 2002 May 15;27(10):E29-36. doi: 10.1097/00007632-200205150-00004.
9. O'Sullivan K, O'Sullivan L, Campbell A, O'Sullivan P. Cognitive functional therapy for disabling nonspecific chronic low back pain: multiple case-cohort study. *Phys Ther.* 2015 Apr;95(4):470-82. doi: 10.2522/ptj.20130573.
10. Van Middelkoop M, Rubinstein SM, Kuijpers T, Verhagen AP, Ostelo R, Koes BW, van Tulder MW.
11. A systematic review on the effectiveness of physical and rehabilitation interventions for chronic non-specific low back pain. *Eur Spine J.* 2011 Jan;20(1):19-39. doi: 10.1007/s00586-010-1518-3.





## On Weak Forms of $(1,2)^*$ - $\gamma$ -Open Sets and Some New Separation Axioms

R.Bhavani \* and S.Andal

Associate Professor, PG and Research Department of Mathematics, Mannar Thirumalai Naicker College, (Affiliated to Madurai Kamaraj University) Madurai, Tamil Nadu, India.

Received: 22 Apr 2024

Revised: 25 Apr 2024

Accepted: 30 Apr 2024

### \*Address for Correspondence

**R.Bhavani**

Associate Professor,  
PG and Research Department of Mathematics,  
Mannar Thirumalai Naicker College,  
(Affiliated to Madurai Kamaraj University)  
Madurai, Tamil Nadu, India.  
Email: bhavani120475@gmail.com.



This is an Open Access Journal / article distributed under the terms of the **Creative Commons Attribution License** (CC BY-NC-ND 3.0) which permits unrestricted use, distribution, and reproduction in any medium, provided the original work is properly cited. All rights reserved.

### ABSTRACT

**Abstract**—In this paper we introduce some generalizations of  $(1,2)^*$ - $\gamma$ -open sets and investigate the new notions called  $(1,2)^*$ - $\alpha$ - $\gamma$ -open sets,  $(1,2)^*$ -pre- $\gamma$ -open sets,  $(1,2)^*$ - $\beta$ - $\gamma$ -open sets and  $(1,2)^*$ -b- $\gamma$ -open sets which are weaker than  $(1,2)^*$ - $\gamma$ -open sets. We obtain the new separation axioms are  $(1,2)^*$ -pre- $\gamma$ - $T_i$ ,  $i=0,1,2$  and  $(1,2)^*$ -pre- $\gamma$ - $D_i$ ,  $i=0,1,2$

**Keywords** –  $(1,2)^*$ - $\alpha$ - $\gamma$ -open sets,  $(1,2)^*$ -pre- $\gamma$ -open sets,  $(1,2)^*$ - $\beta$ - $\gamma$ -open sets and  $(1,2)^*$ -b- $\gamma$ -open sets,  $(1,2)^*$ -pre- $\gamma$ - $T_0$ ,  $(1,2)^*$ -pre- $\gamma$ - $T_1$ ,  $(1,2)^*$ -pre- $\gamma$ - $T_2$ ,  $(1,2)^*$ -pre- $\gamma$ - $D_i$  sets,  $i=0,1,2$

### INTRODUCTION

Let  $(X, \tau_1, \tau_2)$  be a space and  $A$  be a subset of  $X$ . Ogata [1], introduced the concept of  $\gamma$ -open sets and investigated the related topological properties of the associated topology  $\tau_\gamma$  and  $\tau$ , where  $\tau_\gamma$  is the collection of all  $\gamma$ -open sets. An operation  $\gamma$  on a topology  $\tau$  is a mapping from  $\tau$  into power set  $P(X)$  of  $X$  such that  $V \subseteq \gamma(V)$  for each  $V \in \tau$ , where  $\gamma(V)$  denotes the value of  $\gamma$  at  $V$ . Mohammed Nokhans Murad kaki introduced on Some New  $\gamma$ -Type maps [5] on Topological Spaces. Baby Bhattacharya, Arnab Paul [3] introduced  $(1,2)^*$ - $\gamma$ -open sets in bitopological spaces. Then,  $\tau_{(1,2)^*\gamma}$ -set denotes the  $(1,2)^*$ - $\gamma$ -open set in  $X$ . clearly  $\tau_{(1,2)^*\gamma} \subseteq \tau_{12}$ . Complements of  $\gamma$ -open sets are called  $(1,2)^*$ - $\gamma$ -closed. B. Bhattacharya and A. Paul introduced  $\tau_{12}\gamma$ -Int(A) [7] in bitopological space. Complements of  $(1,2)^*$ - $\gamma$ -open sets are  $\tau_{12}\gamma$ -Int(A) and defined to be the union of all  $(1,2)^*$ - $\gamma$ -open sets of  $X$  contained in  $A$ . A bitopological space  $X$  with an operation  $\gamma$  on  $\tau_{12}$  is said to be  $(1,2)^*$ - $\gamma$ -regular [8] iff for each  $x \in X$  and for each  $\tau_{12}$ -open neighbourhood  $V$  of  $x$ , there exists an  $\tau_{12}$ -open neighbourhood  $U$  of  $x$  such that  $(1,2)^*$ - $\gamma(U)$  contained in  $V$ .







**Bhavani and Andal**

It is also to be noted that  $\tau_{12}=\tau_{12\gamma}$  if and only if  $X$  is a  $(1,2)^*\text{-}\gamma$ -regular space .

**Definition 1.1**

Let  $A$  be a subset of a bitopological space  $X$ . Then [6]

- (i) the  $\tau_{1,2}$ -closure of  $A$ , denoted by  $\tau_{1,2}\text{-cl}(A)$ , is defined as  $\cap\{F; A \subseteq F \text{ and } F \text{ is } \tau_{1,2}\text{-closed}\}$
- (ii) the  $\tau_{1,2}$ -interior of  $A$ , denoted by  $\tau_{1,2}\text{-int}(A)$ , is defined as  $\cup\{F; A \subseteq F \text{ and } F \text{ is } \tau_{1,2}\text{-open}\}$

**Definition 1.2**

A subset  $A$  of a bitopological space  $X$  is called

- 1.  $(1,2)^*\text{-}\alpha$ -open [2] if  $A \subseteq \tau_{1,2}\text{-int}(\tau_{1,2}\text{-cl}(\tau_{1,2}\text{-int}(A)))$ ;
- 2.  $(1,2)^*\text{-semi-open}$  [8] if  $A \subseteq \tau_{1,2}\text{-cl}(\tau_{1,2}\text{-int}(A))$ ;
- 3.  $(1,2)^*\text{-pre-open}$  [9] if  $A \subseteq \tau_{1,2}\text{-int}(\tau_{1,2}\text{-cl}(A))$ ;
- 4.  $(1,2)^*\text{-}\beta$ -open [4] if  $A \subseteq \tau_{1,2}\text{-cl}(\tau_{1,2}\text{-int}(\text{cl}(A)))$ ;
- 5.  $(1,2)^*\text{-b-open}$  [10] if  $A \subseteq \tau_{1,2}\text{-int}(\tau_{1,2}\text{-cl}(A)) \cup \tau_{1,2}\text{-cl}(\tau_{1,2}\text{-int}(A))$ .

**Weak Forms Of  $(1,2)^*\text{-}\gamma$ -Open Sets**

**Definition 2.1**

A subset  $A$  of a space  $X$  is said to be:

- 1.  $(1,2)^*\text{-}\alpha\text{-}\gamma$ -open if  $A \subseteq \tau_{(1,2)\gamma}\text{-int}(\tau_{1,2}\text{-cl}(\tau_{(1,2)\gamma}\text{-int}(A)))$ ;
- 2.  $(1,2)^*\text{-pre-}\gamma$ -open if  $A \subseteq \tau_{(1,2)\gamma}\text{-int}(\tau_{1,2}\text{-cl}(A))$ ;
- 3.  $(1,2)^*\text{-}\beta\text{-}\gamma$ -open if  $A \subseteq \tau_{1,2}\text{-cl}(\tau_{(1,2)\gamma}\text{-int}(\tau_{1,2}\text{-cl}(A)))$ ;
- 4.  $(1,2)^*\text{-b-}\gamma$ -open if  $A \subseteq \tau_{(1,2)\gamma}\text{-int}(\tau_{1,2}\text{-cl}(A)) \cup \tau_{1,2}\text{-cl}(\tau_{(1,2)\gamma}\text{-int}(A))$ .

**Lemma 2.2**

Let  $(X, \tau_1, \tau_2)$  be a bitopological space, then the following properties: A subset  $A$  of a space  $X$  is said to be:

- Every  $(1,2)^*\text{-}\gamma$ -open set is  $(1,2)^*\text{-}\alpha\text{-}\gamma$ -open.
- Every  $(1,2)^*\text{-}\alpha\text{-}\gamma$ -open set is  $(1,2)^*\text{-pre-}\gamma$ -open.
- Every  $(1,2)^*\text{-pre-}\gamma$ -open set is  $(1,2)^*\text{-b-}\gamma$ -open.
- Every  $(1,2)^*\text{-b-}\gamma$ -open set is  $(1,2)^*\text{-}\beta\text{-}\gamma$ -open.

**Proof**

1.If  $A$  is a  $(1,2)^*\text{-}\gamma$ -open set, then  $A = \tau_{(1,2)\gamma}\text{-int}(\tau_{1,2}\text{-cl}(A))$ . Since  $A \subseteq \tau_{1,2}\text{-cl}(A)$ , then  $A \subseteq \tau_{1,2}\text{-cl}(\tau_{(1,2)\gamma}\text{-int}(\tau_{1,2}\text{-cl}(A)))$  and  $A \subseteq \tau_{(1,2)\gamma}\text{-int}(\tau_{1,2}\text{-cl}(\tau_{(1,2)\gamma}\text{-int}(\tau_{1,2}\text{-cl}(A))))$ .

Therefore  $A$  is  $(1,2)^*\text{-}\alpha\text{-}\gamma$ -open

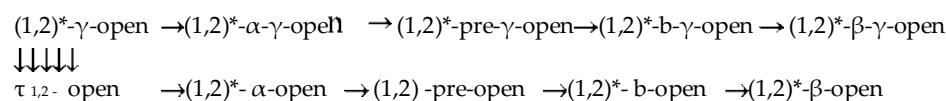
2. If  $A$  is an  $(1,2)^*\text{-}\alpha\text{-}\gamma$ -open set, then  $A \subseteq \tau_{(1,2)\gamma}\text{-int}(\tau_{1,2}\text{-cl}(\tau_{(1,2)\gamma}\text{-int}(A))) \subseteq \tau_{(1,2)\gamma}\text{-int}(\tau_{1,2}\text{-cl}(A))$ . Therefore  $A$  is  $(1,2)^*\text{-pre-}\gamma$ -open.

3.If  $A$  is  $(1,2)^*\text{-pre-}\gamma$ -open, then  $A \subseteq \tau_{(1,2)\gamma}\text{-int}(\text{cl}(A)) \subseteq \tau_{(1,2)\gamma}\text{-int}(\tau_{1,2}\text{-cl}(A)) \cup \tau_{1,2}\text{-cl}(\tau_{(1,2)\gamma}\text{-int}(\tau_{1,2}\text{-cl}(A)))$ . Therefore  $A$  is  $(1,2)^*\text{-b-}\gamma$ -open.

4.If  $A$  is  $(1,2)^*\text{-b-}\gamma$ -open, then  $A \subseteq \tau_{(1,2)\gamma}\text{-int}(\tau_{1,2}\text{-cl}(A)) \cup \tau_{1,2}\text{-cl}(\tau_{(1,2)\gamma}\text{-int}(\tau_{1,2}\text{-cl}(A))) \subseteq \tau_{1,2}\text{-cl}(\tau_{(1,2)\gamma}\text{-int}(\tau_{1,2}\text{-cl}(A))) \cup \tau_{1,2}\text{-cl}(\tau_{(1,2)\gamma}\text{-int}(A)) \subseteq \tau_{1,2}\text{-cl}(\tau_{(1,2)\gamma}\text{-int}(A))$ .

Therefore  $A$  is  $(1,2)^*\text{-}\beta\text{-}\gamma$ -open.

Since every  $(1,2)^*\text{-}\gamma$ -open set is open, then we have the following diagram for properties of subsets.





**Bhavani and Andal**

The above converses need not be true as in the following examples.

**Example 2.3**

Let  $X = \{a, b, c\}$  and  $\tau_1 = \{\emptyset, X, \{a\}, \{a, b\}\}$ ,  $\tau_2 = \{\emptyset, X, \{b\}\}$ . Then the sets in  $\{\emptyset, X, \{a\}, \{b\}, \{a, b\}\}$  are called  $\tau_{1,2}$ -open and the sets in  $\{\emptyset, X, \{b, c\}, \{a, c\}, \{c\}\}$  are called  $\tau_{1,2}$ -closed. Define an operation  $\gamma$  on  $\tau_{1,2}$  by  $\gamma(A) = A$  if  $A = \{a, b\}$  and  $\gamma(A) = X$  otherwise. Clearly,  $\tau_{(1,2)\gamma} = \{\emptyset, X, \{a, b\}\}$ . Then  $\{a\}$  is an  $\tau_{1,2}$ -open set which is not  $(1,2)^*-\beta-\gamma$ -open set.

**Example 2.4**

Let  $X = \{a, b, c, d\}$ ,  $\tau_1 = \{\emptyset, X, \{d\}, \{b, c, d\}\}$ ,  $\tau_2 = \{\emptyset, X, \{b, c\}\}$ ,  $(1,2)^*-\alpha(x) = \{\emptyset, X, \{d\}, \{b, c\}, \{b, c, d\}\}$ ,  $(1,2)^*-\beta(x) = \{\emptyset, X, \{a\}, \{a, d\}, \{a, b, c\}\}$ . Define an operation  $\gamma$  on  $\tau_{(1,2)}$  by  $\gamma(A) = A$  if  $A = \{a, d\}, \{b, c\}$  and  $\gamma(A) = X$  otherwise. Clearly,  $\tau_{(1,2)\gamma} = \{\emptyset, X, \{a, d\}, \{b, c\}\}$ . Here  $\{a, b\}$  is  $(1,2)^*-\beta-\gamma-\alpha(x)$  which is not in  $(1,2)^*-\beta-\gamma-\alpha(x)$ .

**Example 2.5**

Let  $X = \{a, b, c\}$  and  $\tau_1 = \{\emptyset, X, \{b\}, \{a, b\}\}$ ,  $\tau_2 = \{\emptyset, X, \{a\}, \{b, c\}\}$ ,  $(1,2)^*-\alpha(x) = \{\emptyset, X, \{a\}, \{b\}, \{a, b\}, \{b, c\}\}$ ,  $(1,2)^*-\beta(x) = \{\emptyset, X, \{c\}, \{b, c\}, \{a, c\}, \{a\}\}$ . Define an operation  $\gamma$  on  $\tau_{(1,2)}$  by  $\gamma(A) = A$  if  $A = \{b\}$  and  $\gamma(A) = X$  otherwise. Clearly,  $\tau_{(1,2)\gamma} = \{\emptyset, X, \{b\}\}$ .  $(1,2)^*-\beta-\gamma-\alpha(x) = \{\emptyset, X, \{b\}, \{a, b\}, \{b, c\}\}$ ,  $(1,2)^*-\text{pre-}\gamma-\alpha(x) = \{\emptyset, X, \{b\}, \{a, b\}\}$ . Here the set  $\{b, c\}$  is  $(1,2)^*-\beta-\gamma-\alpha(x)$  which is not in  $(1,2)^*-\text{pre-}\gamma-\alpha(x)$ .

**Example 2.6**

Let  $X = \{a, b, c, d\}$  and  $\tau_1 = \{\emptyset, X, \{d\}, \{b, c, d\}\}$ ,  $\tau_2 = \{\emptyset, X, \{b, c\}\}$ . Then  $(1,2)^*-\alpha(x) = \{\emptyset, X, \{d\}, \{b, c\}, \{b, c, d\}\}$  and  $(1,2)^*-\beta(x) = \{\emptyset, X, \{a\}, \{a, d\}, \{a, b, c\}\}$ . Define an operation  $\gamma$  on  $\tau_{(1,2)}$  by  $\gamma(A) = A$  if  $A = \{a, d\}, \{b, c\}$  and  $\gamma(A) = X$  otherwise. Clearly,  $\tau_{(1,2)\gamma} = \{\emptyset, X, \{a, d\}, \{b, c\}\}$ .  $(1,2)^*-\text{pre-}\gamma-\alpha(x) = \{\emptyset, X, \{b\}, \{c\}, \{d\}, \{a, d\}, \{b, c\}, \{b, d\}, \{c, d\}, \{a, b, c\}, \{a, b, d\}, \{b, c, d\}, \{a, c, d\}\}$  and  $(1,2)^*-\alpha-\gamma-\beta-\alpha(x) = \{\emptyset, X, \{a, d\}, \{b, c\}\}$ . Here the set  $\{a, b, c\}$  is a  $(1,2)^*-\text{pre-}\gamma-\alpha$ -open set but it is not in  $(1,2)^*-\alpha-\gamma-\beta-\alpha$ -open.

**Example 2.7**

Let  $X = \{a, b, c\}$  and  $\tau_1 = \{\emptyset, \{a\}, \{a, b\}, X\}$ ,  $\tau_2 = \{\emptyset, X\}$ . Define an operation  $\gamma$  on  $\tau$  by  $\gamma(A) = A$  if  $A = \{a\}$  and  $\gamma(A) = X$  if  $A \neq \{a\}$ . Clearly,  $\tau_{(1,2)\gamma} = \{\emptyset, X, \{a\}\}$ . Then  $\{a, b\}$  is an  $(1,2)^*-\alpha-\gamma$ -open set which is not in  $(1,2)^*-\gamma$ -open.

**Lemma 2.8**

If  $U$  is an open set, then  $\tau_{1,2}-\text{cl}(U \cap A) = \tau_{1,2}-\text{cl}(U \cap \tau_{1,2}-\text{cl}(A))$  and hence  $U \cap \tau_{1,2}-\text{cl}(A) \subseteq \tau_{1,2}-\text{cl}(U \cap A)$  for any subset  $A$  of a space  $X$ .

**Theorem 2.9**

If  $A$  is a  $(1,2)^*-\text{pre-}\gamma$ -open subset of a space  $(X, \tau_1, \tau_2)$  such that  $U \subseteq A \subseteq \tau_{1,2}-\text{cl}(U)$  for a subset  $U$  of  $X$ , then  $U$  is a  $(1,2)^*-\text{pre-}\gamma$ -open set.

**Proof**

Given  $A \subseteq \tau_{(1,2)\gamma}-\text{Int}(\tau_{1,2}-\text{cl}(A))$ ,  $U \subseteq \tau_{(1,2)\gamma}-\text{Int}(\tau_{1,2}-\text{cl}(A))$ . Also  $\tau_{1,2}-\text{cl}(A) \subseteq \tau_{1,2}-\text{cl}(U)$  implies that  $\tau_{(1,2)\gamma}-\text{Int}(\tau_{1,2}-\text{cl}(A)) \subseteq \tau_{(1,2)\gamma}-\text{Int}(\tau_{1,2}-\text{cl}(U))$ . Thus  $U \subseteq \tau_{(1,2)\gamma}-\text{Int}(\tau_{1,2}-\text{cl}(A)) \subseteq \tau_{(1,2)\gamma}-\text{Int}(\tau_{1,2}-\text{cl}(U))$  and hence  $U$  is a  $\text{pre-}\gamma$ -open set.

**Example 2.10**

Let  $X = \{a, b, c\}$  and  $\tau_1 = \{\emptyset, X, \{b\}, \{a, b\}\}$ ,  $\tau_2 = \{\emptyset, X, \{a\}, \{b, c\}\}$ ,  $(1,2)^*-\alpha(x) = \{\emptyset, X, \{a\}, \{b\}, \{a, b\}, \{b, c\}\}$ ,  $(1,2)^*-\beta(x) = \{\emptyset, X, \{c\}, \{b, c\}, \{a, c\}, \{a\}\}$ . Define an operation  $\gamma$  on  $\tau$  by  $\gamma(A) = A$  if  $A = \{b\}$  and  $\gamma(A) = X$  otherwise. Clearly,  $\tau_\gamma = \{\emptyset, X, \{b\}\}$ . Then  $(1,2)^*-\alpha-\gamma-\beta-\alpha(x) = \{\emptyset, X, \{a\}, \{b\}, \{a, b\}, \{b, c\}\}$ ,  $(1,2)^*-\alpha-\gamma-\alpha(x) = \{\emptyset, X, \{b\}\}$ . Here  $\{a, b\}$  is an  $(1,2)^*-\alpha$ -open set in  $X$  which is not  $(1,2)^*-\alpha-\gamma$ -open in  $X$ .





**Bhavani and Andai**

**Example 2.11**

Let  $X = \{a, b, c\}$  and  $\tau_1 = \{\emptyset, X, \{a\}, \{a, b\}\}, \tau_2 = \{\emptyset, X, \{b\}\}$ . Then the sets in  $\{\emptyset, X, \{a\}, \{b\}, \{a, b\}\}$  are called  $\tau_{1,2}$ -open and the sets in  $\{\emptyset, X, \{b, c\}, \{a, c\}, \{c\}\}$  are called  $\tau_{1,2}$ -closed. Define an operation  $\gamma$  on  $\tau$  by  $\gamma(A) = A$  if  $A = \{a, b\}$  and  $\gamma(A) = X$  otherwise. Clearly,  $\tau_\gamma = \{\emptyset, X, \{a, b\}\}$ . Then  $(1,2)^*$ -pre- $\gamma$ -o(x) =  $\{\emptyset, X, \{a\}, \{b\}, \{a, b\}\}$  and  $(1,2)^*$ -pre- $\gamma$ -o(x) =  $\{\emptyset, X, \{a, b\}\}$ . Clearly the set  $\{a\}$  is  $(1,2)^*$ -pre-open in  $X$  but not in  $(1,2)^*$ -pre- $\gamma$ -open in  $X$ .

**Example 2.12**

Let  $X = \{a, b, c\}$  and  $\tau_1 = \{\emptyset, X, \{a\}\}, \tau_2 = \{\emptyset, X, \{b, c\}\}$   $(1,2)^*$ -o(x) =  $\{\emptyset, X, \{a\}, \{b, c\}\}$ ,  $(1,2)^*$ -c(x) =  $\{\emptyset, X, \{b, c\}, \{a\}\}$ . Define an operation  $\gamma$  on  $\tau_\gamma = A$  if  $A = \{a\}$  and  $\gamma(A) = X$  otherwise. Clearly,  $\tau_\gamma = \{\emptyset, X, \{a\}\}$ . Then  $(1,2)^*$ -b-o(X) =  $\{\emptyset, X, \{a\}, \{b\}, \{c\}, \{a, b\}, \{b, c\}, \{a, c\}\}$  and  $(1,2)^*$ -b- $\gamma$ -o(x) =  $\{\emptyset, X, \{a\}, \{a, b\}, \{a, c\}\}$ . Clearly  $\{b, c\}$  is  $(1,2)^*$ -b-open in  $X$  but not  $(1,2)^*$ -b- $\gamma$ -o(x)

**Example 2.13**

Let  $X = \{a, b, c\}$  and  $\tau_1 = \{\emptyset, X, \{b\}, \{b, c\}\}, \tau_2 = \{\emptyset, X, \{a, b\}, \{c\}\}$   $(1,2)^*$ -o(x) =  $\{\emptyset, X, \{b\}, \{c\}, \{a, b\}, \{b, c\}\}$ ,  $(1,2)^*$ -c(x) =  $\{\emptyset, X, \{a, c\}, \{a\}, \{c\}, \{a, b\}\}$ . Define an operation  $\gamma$  on  $\tau_\gamma = A$  if  $A = \{b, c\}$  and  $\gamma(A) = X$  otherwise. Clearly,  $\tau_\gamma = \{\emptyset, X, \{b, c\}\}$ . Clearly the set  $\{a, b\}$  is  $(1,2)^*$ - $\beta$ -open in  $X$  which is not in  $(1,2)^*$ - $\beta$ - $\gamma$ -o(X)

**Proposition 2.14**

The intersection of a  $(1,2)^*$ -pre- $\gamma$ -open set and an open set is  $(1,2)^*$ -pre-open.

**Proof**

Let  $A$  be a  $(1,2)^*$ -pre- $\gamma$ -open set and  $U$  be an open set in  $X$ . Then  $A \subseteq_{(1,2)^*} \tau_{1,2}$ -int( $\tau_{1,2}$ -cl( $A$ )) and  $\tau_{1,2}$ -int( $U$ ) =  $U$  then by Lemma 2.8, we have  $U \cap A \subseteq_{\tau_{1,2}} \tau_{1,2}$ -int( $U$ )  $\cap$   $\tau_{(1,2)^*}$ -int( $\tau_{1,2}$ -cl( $A$ ))  $\subseteq_{\tau_{1,2}}$   $\tau_{1,2}$ -int( $U$ )  $\cap$   $\tau_{1,2}$ -int( $\tau_{1,2}$ -cl( $A$ )) =  $\tau_{1,2}$ -int( $U \cap \tau_{1,2}$ -cl( $A$ ))  $\subseteq_{\tau_{1,2}}$   $\tau_{1,2}$ -int( $\tau_{1,2}$ -cl( $U \cap A$ )). Therefore,  $A \cap U$  is pre-open.

**Proposition 2.15**

The intersection of a  $(1,2)^*$ - $\beta$ - $\gamma$ -open set and an open set is  $(1,2)^*$ - $\beta$ -open.

**Proof**

Let  $U$  be an open set and  $A$  be a  $(1,2)^*$ - $\beta$ - $\gamma$ -open set. Since every  $(1,2)^*$ - $\gamma$ -open set is open, by Lemma 2.8, we have  $U \cap A \subseteq_{\tau_{1,2}} U \cap \tau_{1,2}$ -cl( $\tau_{1,2}$ -int( $\tau_{1,2}$ -cl( $A$ )))  $\subseteq U \cap \tau_{1,2}$ -cl( $\tau_{1,2}$ -int( $\tau_{1,2}$ -cl( $A$ )))  $\subseteq_{\tau_{1,2}}$   $\tau_{1,2}$ -cl( $U \cap \tau_{1,2}$ -int( $\tau_{1,2}$ -cl( $A$ ))) =  $\tau_{1,2}$ -cl( $\tau_{1,2}$ -int( $U$ ))  $\cap$   $\tau_{1,2}$ -int( $\tau_{1,2}$ -cl( $A$ ))) =  $\tau_{1,2}$ -cl( $\tau_{1,2}$ -int( $U \cap \tau_{1,2}$ -cl( $A$ )))  $\subseteq_{\tau_{1,2}}$   $\tau_{1,2}$ -cl( $\tau_{1,2}$ -int( $c_{\tau_{1,2}}$ -cl( $U \cap A$ ))).

This shows that  $U \cap A$  is  $(1,2)^*$ - $\beta$ -open.

We note that the intersection of two  $(1,2)^*$ -pre- $\gamma$ -open (resp.  $(1,2)^*$ - $\beta$ - $\gamma$ -open) sets need not be  $(1,2)^*$ -pre-open (resp.  $(1,2)^*$ - $\beta$ - $\gamma$ -open) as can be seen from the following example:

**Example 2.16**

Let  $X = \{a, b, c\}$  and  $\tau_1 = \{\emptyset, X, \{a, b\}\}, \tau_2 = \{\emptyset, X\}$ . Then  $(1,2)^*$ -o(x) =  $\{\emptyset, X, \{a, b\}\}$   $(1,2)^*$ -c(x) =  $\{\emptyset, X, \{c\}\}$ . Define an operation  $\gamma$  on  $\tau$  by  $\gamma(A) = A$  if  $A = \{a, b\}$  and  $\gamma(A) = X$  otherwise. Clearly,  $\tau_\gamma = \{\emptyset, X, \{a, b\}\}$ . Then  $(1,2)^*$ -pre- $\gamma$ -o(x) =  $\{\emptyset, X, \{a\}, \{b\}, \{a, b\}, \{a, c\}, \{b, c\}\}$  and  $(1,2)^*$ -pre-o(x) =  $\{\emptyset, X, \{a\}, \{b\}, \{a, b\}, \{a, c\}, \{b, c\}\}$ . Let  $A = \{a, c\}, B = \{b, c\}$  which is  $(1,2)^*$ -pre- $\gamma$ -open in  $X$ . But  $A \cap B = \{c\}$  which is not in  $(1,2)^*$ -pre-open in  $X$ .

**Proposition 2.17**

The intersection of an  $(1,2)^*$ - $\alpha$ - $\gamma$ -open set and an open set is  $(1,2)^*$ - $\alpha$ -open.

**Theorem 2.18**

If  $\{A_k : k \in \Delta\}$  is a collection of  $(1,2)^*$ -b- $\gamma$ -open (resp.  $(1,2)^*$ - $\alpha$ - $\gamma$ -open,  $(1,2)^*$ -pre- $\gamma$ -open,  $(1,2)^*$ - $\beta$ - $\gamma$ -open) sets of a space  $(X, \tau_1, \tau_2)$ , then  $\cup_{k \in \Delta} A_k$  is  $(1,2)^*$ -b- $\gamma$ -open (resp.  $(1,2)^*$ - $\alpha$ -open,  $(1,2)^*$ -pre- $\gamma$ -open,  $(1,2)^*$ - $\beta$ - $\gamma$ -open).





**Bhavani and Andal**

**Proof**

We only prove the first case as other cases are shown in the same way. Since  $A_k \subseteq (\tau_{1,2})^{-1} \tau_{1,2} \text{-int}(\tau_{1,2} \text{-cl}(A_k)) \cup \tau_{1,2} \text{-cl}(\tau_{1,2})^{-1} \tau_{1,2} \text{-int}(A_k)$  for every  $k \in \Delta$ , we have  $\cup_{k \in \Delta} A_k \subseteq \cup_{k \in \Delta} [\tau_{1,2})^{-1} \tau_{1,2} \text{-int}(\tau_{1,2} \text{-cl}(A_k)) \cup \tau_{1,2} \text{-cl}(\tau_{1,2})^{-1} \tau_{1,2} \text{-int}(A_k)] \subseteq [\cup_{k \in \Delta} \tau_{1,2})^{-1} \tau_{1,2} \text{-int}(\tau_{1,2} \text{-cl}(A_k))] \cup [\cup_{k \in \Delta} \tau_{1,2} \text{-cl}(\tau_{1,2})^{-1} \tau_{1,2} \text{-int}(A_k)] \subseteq [\tau_{1,2})^{-1} \tau_{1,2} \text{-int}(\cup_{k \in \Delta} \tau_{1,2} \text{-cl}(A_k))] \cup [\tau_{1,2} \text{-cl}(\cup_{k \in \Delta} \tau_{1,2})^{-1} \tau_{1,2} \text{-int}(A_k)] \subseteq [\tau_{1,2})^{-1} \tau_{1,2} \text{-int}(\tau_{1,2} \text{-cl}(\cup_{k \in \Delta} A_k))] \cup [\tau_{1,2} \text{-cl}(\tau_{1,2})^{-1} \tau_{1,2} \text{-int}(\cup_{k \in \Delta} A_k)]$ . Therefore,  $\cup_{k \in \Delta} A_k$  is  $(1,2)^* \text{-b-}\gamma \text{-open}$ .

We note that the intersection of two  $(1,2)^* \text{-pre-}\gamma \text{-open}$  (resp.  $(1,2)^* \text{-}\alpha \text{-}\gamma \text{-open}$ ,  $(1,2)^* \text{-b-}\gamma \text{-open}$ ,  $(1,2)^* \text{-}\beta \text{-}\gamma \text{-open}$ ) sets need not be  $(1,2)^* \text{-pre-}\gamma \text{-open}$  (resp.  $(1,2)^* \text{-}\alpha \text{-}\gamma \text{-open}$ ,  $(1,2)^* \text{-b-}\gamma \text{-open}$ ,  $(1,2)^* \text{-}\beta \text{-}\gamma \text{-open}$ ) as can be seen from the following example:

**Example 2.19**

Let  $X = \{a, b, c\}$  and  $\tau_1 = \{\emptyset, x, \{b\}, \{b, c\}, \{a, c\}, \{c\}\}$ ,  $\tau_2 = \{\emptyset, x\}$ . Then  $(1,2)^* \text{-o}(x) = \{\emptyset, x, \{b\}, \{b, c\}, \{a, c\}, \{c\}\}$ ,  $(1,2)^* \text{-c}(x) = \{\{a\}, \{b\}, \{a, b\}, \{a, c\}\}$ . Describe the function  $\gamma$  in  $\tau$  with  $\gamma(A) = A$  if  $A = \{a, c\}$  or  $\{b, c\}$  and  $\gamma(A) = X$  otherwise. Clearly,  $\tau_{1,2} \text{-}\gamma = \{\emptyset, X, \{a, c\}, \{b, c\}\}$ . Let  $A = \{a, c\}$  and  $B = \{b, c\}$ , then  $A$  and  $B$  are  $(1,2)^* \text{-pre-}\gamma \text{-open}$  (resp.  $(1,2)^* \text{-}\alpha \text{-}\gamma \text{-open}$ ,  $(1,2)^* \text{-b-}\gamma \text{-open}$ ,  $(1,2)^* \text{-}\beta \text{-}\gamma \text{-open}$ ), but  $A \cap B = \{c\}$  which is not in  $(1,2)^* \text{-pre-}\gamma \text{-open}$  (resp.  $(1,2)^* \text{-}\alpha \text{-}\gamma \text{-open}$ ,  $(1,2)^* \text{-b-}\gamma \text{-open}$ ,  $(1,2)^* \text{-}\beta \text{-}\gamma \text{-open}$ ).

**New Separation Axioms**

**Definition**

A bitopological space  $(X, \tau_1, \tau_2)$  with an operation  $\gamma$  on  $\tau_1$  is said to be:

1.  $(1,2)^* \text{-pre-}\gamma \text{-}T_0$  (resp.  $(1,2)^* \text{-}\alpha \text{-}\gamma \text{-}T_0$ ,  $(1,2)^* \text{-b-}\gamma \text{-}T_0$ ,  $(1,2)^* \text{-}\beta \text{-}\gamma \text{-}T_0$ ) if for each pair of distinct points  $x, y$  in  $X$ , there exists a  $(1,2)^* \text{-pre-}\gamma \text{-open}$  (resp.  $(1,2)^* \text{-}\alpha \text{-}\gamma \text{-open}$ ,  $(1,2)^* \text{-b-}\gamma \text{-open}$ ,  $(1,2)^* \text{-}\beta \text{-}\gamma \text{-open}$ ) set  $U$  such that either  $x \in U$  and  $y \notin U$  or  $x \notin U$  and  $y \in U$ .
2.  $(1,2)^* \text{-pre-}\gamma \text{-}T_1$  (resp.  $(1,2)^* \text{-}\alpha \text{-}\gamma \text{-}T_1$ ,  $(1,2)^* \text{-b-}\gamma \text{-}T_1$ ,  $(1,2)^* \text{-}\beta \text{-}\gamma \text{-}T_1$ ) if for each pair of distinct points  $x, y$  in  $X$ , there exist two  $(1,2)^* \text{-pre-}\gamma \text{-open}$  (resp.  $(1,2)^* \text{-}\alpha \text{-}\gamma \text{-open}$ ,  $(1,2)^* \text{-b-}\gamma \text{-open}$ ,  $(1,2)^* \text{-}\beta \text{-}\gamma \text{-open}$ ) sets  $U$  and  $V$  such that  $x \in U$  but  $y \notin U$  and  $y \in V$  but  $x \notin V$ .
3.  $(1,2)^* \text{-pre-}\gamma \text{-}T_2$  (resp.  $(1,2)^* \text{-}\alpha \text{-}\gamma \text{-}T_2$ ,  $(1,2)^* \text{-b-}\gamma \text{-}T_2$ ,  $(1,2)^* \text{-}\beta \text{-}\gamma \text{-}T_2$ ) if for each distinct points  $x, y$  in  $X$ , there exist two disjoint  $(1,2)^* \text{-pre-}\gamma \text{-open}$  (resp.  $(1,2)^* \text{-}\alpha \text{-}\gamma \text{-open}$ ,  $(1,2)^* \text{-b-}\gamma \text{-open}$ ,  $(1,2)^* \text{-}\beta \text{-}\gamma \text{-open}$ ) sets  $U$  and  $V$  containing  $x$  and  $y$  respectively.

**Remark 3.2**

For a bitopological space  $(X, \tau_1, \tau_2)$  with an operation  $\gamma$  on  $\tau_1$ , the following properties hold:

1. If  $(X, \tau_1, \tau_2)$  is  $(1,2)^* \text{-}\alpha \text{-}\gamma \text{-}T_i$ , then it is  $(1,2)^* \text{-pre-}\gamma \text{-}T_i$ , for  $i = 0, 1, 2$ .
2. If  $(X, \tau_1, \tau_2)$  is  $(1,2)^* \text{-pre-}\gamma \text{-}T_i$ , then it is  $(1,2)^* \text{-b-}\gamma \text{-}T_i$ , for  $i = 0, 1, 2$ .
3. If  $(X, \tau_1, \tau_2)$  is  $(1,2)^* \text{-b-}\gamma \text{-}T_i$ , then it is  $(1,2)^* \text{-}\beta \text{-}\gamma \text{-}T_i$ , for  $i = 0, 1, 2$ .

**Definition 3.3**

A subset  $A$  of a bitopological space  $X$  is called a  $(1,2)^* \text{-pre-}\gamma \text{-D-set}$  (resp.  $(1,2)^* \text{-}\alpha \text{-}\gamma \text{-D-set}$ ,  $(1,2)^* \text{-b-}\gamma \text{-D-set}$ ,  $(1,2)^* \text{-}\beta \text{-}\gamma \text{-D-set}$ ) if there are two  $(1,2)^* \text{-pre-}\gamma \text{-open}$  (resp.  $(1,2)^* \text{-}\alpha \text{-}\gamma \text{-open}$ ,  $(1,2)^* \text{-b-}\gamma \text{-open}$ ,  $(1,2)^* \text{-}\beta \text{-}\gamma \text{-open}$ ) sets  $U$  and  $V$  such that  $U \neq X$  and  $A = U \setminus V$ . It is true that every  $\text{pre-}\gamma \text{-open}$  (resp.  $(1,2)^* \text{-}\alpha \text{-}\gamma \text{-open}$ ,  $(1,2)^* \text{-b-}\gamma \text{-open}$ ,  $(1,2)^* \text{-}\beta \text{-}\gamma \text{-open}$ ) set  $U$  different from  $X$  is a  $\text{pre-}\gamma \text{-D-set}$  (resp.  $(1,2)^* \text{-}\alpha \text{-}\gamma \text{-D-set}$ ,  $(1,2)^* \text{-b-}\gamma \text{-D-set}$ ,  $(1,2)^* \text{-}\beta \text{-}\gamma \text{-D-set}$ ) if  $A = U$  and  $V = \emptyset$ .

**Remark 3.4**

Every proper  $(1,2)^* \text{-pre-}\gamma \text{-open}$  (resp.  $(1,2)^* \text{-}\alpha \text{-}\gamma \text{-open}$ ,  $(1,2)^* \text{-b-}\gamma \text{-open}$ ,  $(1,2)^* \text{-}\beta \text{-}\gamma \text{-open}$ ) set is a  $(1,2)^* \text{-pre-}\gamma \text{-D-set}$  (resp.  $(1,2)^* \text{-}\alpha \text{-}\gamma \text{-D-set}$ ,  $(1,2)^* \text{-b-}\gamma \text{-D-set}$ ,  $(1,2)^* \text{-}\beta \text{-}\gamma \text{-D-set}$ ).





**Bhavani and Andal**

**Remark 3.5**

For a bitopological space  $(X, \tau_1, \tau_2)$  with an operation  $\gamma$  on  $\tau_1$ , the following properties hold:

1. Every  $(1,2)^*\text{-}\alpha\text{-}\gamma\text{-}D$ -set is  $(1,2)^*\text{-pre-}\gamma\text{-}D$ -set.
2. Every  $(1,2)^*\text{-pre-}\gamma\text{-}D$ -set is  $(1,2)^*\text{-b-}\gamma\text{-}D$ -set.
3. Every  $(1,2)^*\text{-b-}\gamma\text{-}D$ -set is  $(1,2)^*\text{-}\beta\text{-}\gamma\text{-}D$ -set.

**Definition 3.6**

A bitopological space  $(X, \tau_1, \tau_2)$  with an operation  $\gamma$  on  $\tau_1$  is said to be:

1.  $(1,2)^*\text{-pre-}\gamma\text{-}D_0$  (resp.  $(1,2)^*\text{-}\alpha\text{-}\gamma\text{-}D_0, (1,2)^*\text{-b-}\gamma\text{-}D_0, (1,2)^*\text{-}\beta\text{-}\gamma\text{-}D_0$ ) if for any pair of distinct points  $x$  and  $y$  of  $X$  there exists a  $(1,2)^*\text{-pre-}\gamma\text{-}D$ -set (resp.  $(1,2)^*\text{-}\alpha\text{-}\gamma\text{-}D$ -set,  $(1,2)^*\text{-b-}\gamma\text{-}D$ -set,  $(1,2)^*\text{-}\beta\text{-}\gamma\text{-}D$ -set) of  $X$  containing  $x$  but not  $y$  or a  $(1,2)^*\text{-}\gamma\text{-}b\text{-}D$ -set of  $X$  containing  $y$  but not  $x$ .
2.  $(1,2)^*\text{-pre-}\gamma\text{-}D_1$  (resp.  $(1,2)^*\text{-}\alpha\text{-}\gamma\text{-}D_1, (1,2)^*\text{-b-}\gamma\text{-}D_1, (1,2)^*\text{-}\beta\text{-}\gamma\text{-}D_1$ ) if for any pair of distinct points  $x$  and  $y$  of  $X$  there exist two  $(1,2)^*\text{-pre-}\gamma\text{-}D$ -sets (resp.  $(1,2)^*\text{-}\alpha\text{-}\gamma\text{-}D$ -sets,  $(1,2)^*\text{-b-}\gamma\text{-}D$ -sets,  $(1,2)^*\text{-}\beta\text{-}\gamma\text{-}D$ -sets)  $U$  and  $V$  such that  $x \in U$  but  $y \notin U$  and  $y \in V$  but  $x \notin V$ .
3.  $(1,2)^*\text{-pre-}\gamma\text{-}D_2$  (resp.  $(1,2)^*\text{-}\alpha\text{-}\gamma\text{-}D_2, (1,2)^*\text{-b-}\gamma\text{-}D_2, (1,2)^*\text{-}\beta\text{-}\gamma\text{-}D_2$ ) if for any pair of distinct points  $x$  and  $y$  of  $X$  there exist disjoint  $(1,2)^*\text{-pre-}\gamma\text{-}D$ -sets (resp.  $(1,2)^*\text{-}\alpha\text{-}\gamma\text{-}D$ -sets,  $(1,2)^*\text{-b-}\gamma\text{-}D$ -sets,  $(1,2)^*\text{-}\beta\text{-}\gamma\text{-}D$ -sets)  $G$  and  $E$  of  $X$  containing  $x$  and  $y$  respectively.

**Remark 3.7**

A bitopological space  $(X, \tau_1, \tau_2)$  with an operation  $\gamma$  on  $\tau_1$ , the following properties hold:

1. If  $(X, \tau_1, \tau_2)$  is  $(1,2)^*\text{-}\alpha\text{-}\gamma\text{-}D_i$ , then it is  $(1,2)^*\text{-pre-}\gamma\text{-}D_i$ , for  $i = 0, 1, 2$ . If  $(X, \tau_1, \tau_2)$  is  $(1,2)^*\text{-pre-}\gamma\text{-}D_i$ , then it is  $(1,2)^*\text{-b-}\gamma\text{-}D_i$ , for  $i = 0, 1, 2$ .
2. If  $(X, \tau_1, \tau_2)$  is  $(1,2)^*\text{-b-}\gamma\text{-}D_i$ , then it is  $(1,2)^*\text{-}\beta\text{-}\gamma\text{-}D_i$ , for  $i = 0, 1, 2$ .

**Definition 3.8**

Point  $x \in X$  with only  $X$  as the  $(1,2)^*\text{-pre-}\gamma\text{-neighborhood}$  (resp.  $(1,2)^*\text{-}\alpha\text{-}\gamma\text{-neighborhood}, (1,2)^*\text{-b-}\gamma\text{-neighborhood}, (1,2)^*\text{-}\beta\text{-}\gamma\text{-neighborhood}$ ) is called a  $(1,2)^*\text{-pre-}\gamma\text{-neat point}$  (resp.  $(1,2)^*\text{-}\alpha\text{-}\gamma\text{-neat point}, (1,2)^*\text{-b-}\gamma\text{-neat point}, (1,2)^*\text{-}\beta\text{-}\gamma\text{-neat point}$ ).

**Theorem 3.9**

For a  $(1,2)^*\text{-pre-}\gamma\text{-}T_0$  (resp.  $(1,2)^*\text{-}\alpha\text{-}\gamma\text{-}T_0, (1,2)^*\text{-b-}\gamma\text{-}T_0, (1,2)^*\text{-}\beta\text{-}\gamma\text{-}T_0$ ) topological space  $(X, \tau_1, \tau_2)$  the following are equivalent:

1.  $(X, \tau_1, \tau_2)$  is  $(1,2)^*\text{-pre-}\gamma\text{-}D_1$  (resp.  $(1,2)^*\text{-}\alpha\text{-}\gamma\text{-}D_1, (1,2)^*\text{-b-}\gamma\text{-}D_1, (1,2)^*\text{-}\beta\text{-}\gamma\text{-}D_1$ ).
2.  $(X, \tau_1, \tau_2)$  has no  $(1,2)^*\text{-pre-}\gamma\text{-neat point}$  (resp.  $(1,2)^*\text{-}\alpha\text{-}\gamma\text{-neat point}, (1,2)^*\text{-b-}\gamma\text{-neat point}, (1,2)^*\text{-}\beta\text{-}\gamma\text{-neat point}$ ).

**Proof**

$1 \Rightarrow 2$ . Since  $(X, \tau_1, \tau_2)$  is  $(1,2)^*\text{-pre-}\gamma\text{-}D_1$  (resp.  $(1,2)^*\text{-}\alpha\text{-}\gamma\text{-}D_1, (1,2)^*\text{-b-}\gamma\text{-}D_1, (1,2)^*\text{-}\beta\text{-}\gamma\text{-}D_1$ ), then each point  $x$  of  $X$  is contained in a  $(1,2)^*\text{-pre-}\gamma\text{-}D$ -set (resp.  $(1,2)^*\text{-}\alpha\text{-}\gamma\text{-}D$ -set,  $(1,2)^*\text{-b-}\gamma\text{-}D$ -set,  $(1,2)^*\text{-}\beta\text{-}\gamma\text{-}D$ -set)  $A = U \setminus V$  and thus in  $U$ . By definition  $U \neq X$ . This implies that  $x$  is not a  $(1,2)^*\text{-pre-}\gamma\text{-neat point}$  (resp.  $(1,2)^*\text{-}\alpha\text{-}\gamma\text{-neat point}, (1,2)^*\text{-b-}\gamma\text{-neat point}, (1,2)^*\text{-}\beta\text{-}\gamma\text{-neat point}$ ).

$2 \Rightarrow 1$ . If  $X$  is  $(1,2)^*\text{-pre-}\gamma\text{-}T_0$  (resp.  $(1,2)^*\text{-}\alpha\text{-}\gamma\text{-}T_0, (1,2)^*\text{-b-}\gamma\text{-}T_0, (1,2)^*\text{-}\beta\text{-}\gamma\text{-}T_0$ ), then each pair of different points  $x, y \in X$ , at least one of them,  $x$  (say) have  $(1,2)^*\text{-pre-}\gamma\text{-neighborhood}$  (resp.  $(1,2)^*\text{-}\alpha\text{-}\gamma\text{-neighborhood}, (1,2)^*\text{-b-}\gamma\text{-neighborhood}, (1,2)^*\text{-}\beta\text{-}\gamma\text{-neighborhood}$ )  $U$  contains  $x$  and not  $y$ . So the difference from  $X$  is a  $(1,2)^*\text{-pre-}\gamma\text{-}D$ -set (resp.  $\alpha\text{-}\gamma\text{-}D$ -set,  $b\text{-}\gamma\text{-}D$ -set,  $\beta\text{-}\gamma\text{-}D$ -set). If  $X$  has no  $(1,2)^*\text{-pre-}\gamma\text{-neat point}$  (resp.  $(1,2)^*\text{-}\alpha\text{-}\gamma\text{-neat point}, (1,2)^*\text{-b-}\gamma\text{-neat point}, (1,2)^*\text{-}\beta\text{-}\gamma\text{-neat point}$ ). This means that there exists a  $(1,2)^*\text{-pre-}\gamma\text{-neighborhood}$  (resp.

$(1,2)^*\text{-}\alpha\text{-}\gamma\text{-neighborhood}, (1,2)^*\text{-b-}\gamma\text{-neighborhood}, (1,2)^*\text{-}\beta\text{-}\gamma\text{-neighborhood}$ )  $V$  of  $y \in V \neq X$ . Thus  $y \in V \setminus U$  but not  $x$  and  $V \setminus U$  is a  $(1,2)^*\text{-pre-}\gamma\text{-}D$ -set (resp.  $(1,2)^*\text{-}\alpha\text{-}\gamma\text{-}D$ -set,  $(1,2)^*\text{-b-}\gamma\text{-}D$ -set,  $(1,2)^*\text{-}\beta\text{-}\gamma\text{-}D$ -set). Hence  $X$  is  $(1,2)^*\text{-pre-}\gamma\text{-}D_1$  (resp.  $(1,2)^*\text{-}\alpha\text{-}\gamma\text{-}D_1, (1,2)^*\text{-b-}\gamma\text{-}D_1, (1,2)^*\text{-}\beta\text{-}\gamma\text{-}D_1$ ).





## CONCLUSION

A new class of sets are called  $(1,2)^*$ - $\gamma$ -open sets in a bitopological space  $(X, \tau_1, \tau_2)$  together with its compliment which is  $(1,2)^*$ - $\gamma$ -closed sets. The purpose of this paper is to present and investigated some more separation axioms are called  $(1,2)^*$ -pre- $\gamma$ - $T_i$ , and  $(1,2)^*$ -pre- $\gamma$ - $D_i$  spaces, for  $i=0,1,2$ . Some new separation axioms and weak forms have been founded, they turn out to be useful in the study of digital topology. Therefore, all bitopological sets and functions defined will have many possibilities of applications in digital topology and computer graphics.

## REFERENCES

1. H. Ogata, Operation on topological spaces and associated topology, Math. Japonica, 36: 175-184 (1991).
2. M.L.Thivagar, Generalization of pairwise alpha –continuous functions, Pure and Applied Matematika sciences, 33(1-2) 1991, 55-63.
3. B.Bhattacharya and A.Paul, On bitopological  $\gamma$ - open set, Ioso Journal of Mathematics, 5(2),(2013), 10-14.
4. F.H.Kheder, S.M.AL.Areefi and T.Noiri, Pre continuity and Semi-Pre continuity in bitopological Spaces. Indian J.Pure Applied maths.23(9), 127-132(1992)
5. On some New  $\gamma$ -type maps on topological spaces, Mohammed Nokhas Murad Kaki, Journal of Mathematical Sciences Advances and Applications, Vol 20, 2013, Pages 45-60.
6. B.Bhattacharya and A. Paul, A New Approach of  $\gamma$ - open sets in bitopological spaces. Gen.Math.Notes. Vol 20 , No.2 ,Feb(2014)
7. Baravan,A, Asaad Nazihah Ahmed and Zurniomar,  $\gamma$ - regular open sets and  $\gamma$ -Extremally Disconnected spaces, Mathematical Theory and Modeling, Vol 3, No.12,(2013).
8. T.Fnkntake, Semiopen Sets on bitopological Spaces, Bull Fukuoka Uni.Education,38(3),1989,PP: 1-7
9. M.Jelic, A decomposition of pairwise continuity, J.Inst. Math.Computer. Science.Math, Sec.3(1990),25-29.
10. M.Lellis Thivagar and B.Meera Devi, Bitopological B-open sets, International Journal of Algorithms, Computing and Mathematics, Volume 3, No.3, Aug(2010).





## Effectiveness of Physiotherapy Treatment on Functional Capacity in Post COVID -19 Young Adults

Advita Neville Deepak<sup>1</sup>, Madhavan G Iyenger<sup>2</sup> and Bhavana Gadhavi<sup>3</sup>

<sup>1</sup>Ph.D Scholar and Associate Professor, Department of Physiotherapy, College of Physiotherapy, Parul University, Vadodara, Gujarat, India.

<sup>2</sup>Professor, Department of Surgery, Parul Institute of Medical science and Research, Parul University, Vadodara, Gujarat, India.

<sup>3</sup>Principal and Dean, Department of Physiotherapy, Parul institute of Physiotherapy, Parul University, Vadodara, Gujarat, India.

Received: 22 Jan 2024

Revised: 09 Feb 2024

Accepted: 11 May 2024

### \*Address for Correspondence

#### Advita Neville Deepak

Ph.D Scholar and Associate Professor,

Department of Physiotherapy,

College of Physiotherapy,

Parul University,

Vadodara, Gujarat, India.

Email: advita.deepak@paruluniversity.ac.in



This is an Open Access Journal / article distributed under the terms of the **Creative Commons Attribution License** (CC BY-NC-ND 3.0) which permits unrestricted use, distribution, and reproduction in any medium, provided the original work is properly cited. All rights reserved.

### ABSTRACT

**Background:** COVID-19 is illness caused by infection with novel corona virus SARS-CoV-19. Aerobic and vigorous exercise plays important role in enhancing cardio respiratory and musculoskeletal performance, focusing on restoring and improving the quality of life of populations affected by Covid-19. This study aimed to analyse effect of physiotherapy treatment to improve functional capacity in post COVID-19 survivors. Sample of 100 (n=100) post covid individual between the age of 18-35 years with decreased functional capacity were included in study. Subjects were divided into 50 in each group. Group A (Intervention group) and Group B (control group). This study is carried out for duration of 4months for Group A and for Group B no protocol. Experimental study Outcomes would be calculated at the start of treatment and at the end of the last day of treatment by using Six minute walk test. The statistical analysis of the data was performed using the SPSS 10 program and included the repeated measurement ANOVA (for measuring 6MWT ranked variables from baseline to 120 day), the Mann-Whitney U test (for measuring the significance of the differences between both the group of patients). All differences were considered significant at  $p < 0.001$ . Therefore, we concluded that Physiotherapy treatment is an effective and beneficial therapy for post COVID 19 young adults for improving functional capacity.

**Keywords:** COVID 19, Functional capacity, Six minute walk test





## INTRODUCTION

COVID-19 is an illness caused by infection with a novel corona virus SARS-CoV-19. The 2019-novel is mainly transmitted by respiratory droplets and close contact. Most patients presenting with fever, cough, shortness of breath, nausea, vomiting, fatigue, and loss of taste. In some cases, if complicated form leading to death is characterized by ARDS, pneumonia, heart failure and secondary infection.[1,2] Respiratory disorders and lack of exercise in the elderly can lead to morbidity such as apraxia syndrome and pulmonary infection.[6] Post-SARS patients complained of difficulty in activities of daily living such as walking (level, uphill), stair climbing and housework. Physiotherapy is an integral part of critical care management. Physiotherapy in critical care aims to prevent and manage pulmonary complications and focus on early rehabilitation while minimizing complications of immobility [3, 5] Physiotherapy has proven to be highly relevant for the treatment of post-Covid-19 patients. Physiotherapy can help restore body functions. Physical Therapy is a key tool for reducing dyspnoea, improving lung capacity, reducing levels of anxiety as well as increasing muscle strength affected by these diseases.

### NEED OF THE STUDY

There is a lack of knowledge and evidence of long-term outcomes of the disease and effect of Physiotherapy Treatment in post COVID-19 young adults.<sup>6</sup> For young adults going through post COVID -19 traumatization without being exposed to the outer environment and may help them to improve their QOL and functional capacity. So, this study helps to determine the effect of Physiotherapy Treatment in post COVID -19 young adults

## METHODOLOGY

**Source of Data:** Post COVID-19 young adults from Parul University.

**Sample Size:** 100 subjects (Group A: 50 Subjects, Group B: 50 Subjects)

**Study Design:** An Experimental study

**Inclusion Criteria** are age between 18-35 yr, willing to fill informed consent, both genders are included, patient who are able to understand and follow simple verbal instruction

**Exclusion criteria** are pregnant women, subjects with complete hearing loss. Subject's age below 18 and more than 35 year, subjects with physically and mentally challenged, subjects with completely blind and deaf, the participants receiving any cardiopulmonary fitness training. History of cardiac and chronic pulmonary diseases, history of thoracic surgery and abdominal surgery. Intervention Duration: The study was carried out for the duration of 4 months. The protocol for the Group A was for 3 days in a week for 8 weeks. No protocol for Group B only given carp positioning and advised for 20 minutes walking. Evaluation was taken at 0 day, 60<sup>th</sup> day and 120<sup>th</sup> day.

### OUTCOME MEASURES

Six minute walk test

### PROCEDURE

The sample of 100 patients of post COVID 19 young adults between 18-35 years was taken for the study. Group A (Intervention group) and Group B (Control group). Group A received the given treatment for total duration of 3 days per weeks. The treatment protocol consist of breathing exercise (diaphragmatic and thoracic expansion) for 10 minutes, aerobic exercises (low intensity exercise with rest). Resistance training (for upper and lower limb exercise with 0.5 kg to 1kg weight) for 8-10 minutes and breathing control (pursed lip breathing) for 5 times Group B advised for carp positioning and 20 minutes walking. Both group were assessed 0 day, 60<sup>th</sup> day and 120<sup>th</sup> day using Six minute walk test and the data was recorded and final results was analysed.







Advita Neville Deepak *et al.*,

## RESULT

### Comparison in mean difference for distance in experimental and Control Group.

#### Experimental Group

For a baseline mean distance was 546.8 with SD 20.1 which is increased to 652.3 with SD 25.1 at the time of 60 Day. Also, at the time of 120 day it was increased to 654.7 with SD 25.1. There is significance difference in distance at different timepoints in Experimental group with  $p$  – value  $<0.001$ (significance level). i.e., there is a significance improvement in the measure of distance in Experimental Group.

#### Control Group

For a baseline mean distance was 543.1 with SD 11.3 which is increased to 562.7 with SD 29.5 at the time of 60 Day. Also, at the time of 120 day it was increased to 567.4 with SD 35.6. There is significance difference in measures of distance at different time points in control group with  $p$  – value  $<0.001$  (significance level). i.e., there is a significance improvement in the measure of distance in Control Group. Pair wise comparison of mean for difference in Distance at different time point in Experimental Group and Control Group.

#### Experimental Group

There is significance difference in Distance for each pair of time points with  $p$  – value  $<0.001$  (significance level). i.e., there is significance improvement in measure of distance from baseline to 120 Day.

#### Control Group

There is significance difference in distance for all pair of time points with  $p$  –value  $<0.05$  (significance level). i.e., there is significance improvement in measure of distance baseline to 120 Day.

#### Experimental Group

For a baseline mean VO<sub>2</sub> MAX was 28.8 with SD 4.2 which is increased to 35.1 with SD 4.1 at the time of 60 Day. Also, at the time of 120 day it was increased to 35.2 with SD 4.1. There is significance difference in VO<sub>2</sub> MAX at different time points in Experimental group with  $p$  – value  $<0.001$ (significance level). i.e., there is a significance improvement in the measure of VO<sub>2</sub>MAX in Experimental Group.

#### Control Group

For a baseline mean VO<sub>2</sub> MAX was 29.9 with SD 3.2 which is increased to 31.0 with SD 3.3 at the time of 60 Day. Also, at the time of 120 day it was increased to 31.3 with SD 3.4. There is significance difference in measures of VO<sub>2</sub> MAX at different time points in control group with  $p$  – value  $<0.001$  (significance level). i.e., there is a significance improvement in the measure of VO<sub>2</sub> MAX in Control Group. Pair wise comparison of mean for difference in Distance at different time point in Experimental Group and Control Group.

#### Experimental Group

There is significance difference in VO<sub>2</sub> MAX for each pair of time points with  $p$  – value  $<0.05$  (significance level). i.e., there is significance improvement in measure of VO<sub>2</sub> MAX from baseline to 120 Day.

#### Control Group

There is significance difference in VO<sub>2</sub> MAX for all pair of time points with  $p$  – value  $<0.05$  (significance level). i.e., there is significance improvement in measure of VO<sub>2</sub>MAX baseline to 120 Day.

## CONCLUSION

Therefore, we concluded that Physiotherapy Treatment is an effective and beneficial to improve Functional Capacity in post COVID 19 young adults compared to other group.





Advita Neville Deepak et al.,

## REFERENCE

1. Paz LE, da Silva Bezerra BJ, de Me lo Pereira TM, da Silva WE. COVID-19: the importance of physical therapy in the recovery of workers' health. *Revista Brasileira de Medicina do Trabalho*. 2021 Jan;19(1):94.
2. Ponce-Campos SD, Díaz JM, Moreno-Agundis D, González-Delgado AL, Andrade- Lozano P, Avelar-González FJ, Hernández-Cuellar E, Torres-Flores F. A physiotherapy treatment plan for post-COVID-19 patients that improves the FEV1, FVC, and 6-Min walk values, and reduces the sequelae in 12 sessions. *Frontiers in Rehabilitation Sciences*. 2022;3
3. Jiandani MP, Agarwal B, Baxi G, Kale S, Pol T, Bhise A, Pandit U, Shetye JV, Diwate A, Damke U, Ravindra S. Evidence-based National Consensus: Recommendations for Physiotherapy Management in COVID-19 in Acute Care Indian Setup. *Indian Journal of Critical Care Medicine: Peer-reviewed, Official Publication of Indian Society of Critical Care Medicine*. 2020 Oct;24(10):905.
4. Silva RM, Sousa AV. Fase crônica da COVID-19: desafios do fisioterapeuta diante das disfunções musculoesqueléticas. *Fisioterapia em Movimento*. 2020 May 29;33.
5. Scheiber B, Spiegl C, Wiederin C, Schifferegger E, Schiefermeier-Mach N. Post- COVID-19 rehabilitation: perception and experience of Austrian physiotherapists and physiotherapy students. *International journal of environmental research and public health*. 2021 Aug 18;18(16):8730
6. Effectiveness of virtual physiotherapy rehabilitation on functional capacity and quality of life in subjects recovered from covid-19 in India. (2023, November 1). *International Journal of Biology, Pharmacy and Allied Sciences*, 12(11). <https://doi.org/10.31032/ijbpas/2023/12.11.7528>
7. Nopp S, Moik F, Klok FA, Gattinger D, Petrovic M, Vonbank K, Koczulla AR, Ay C, Zwick RH. Outpatient pulmonary rehabilitation in patients with long COVID improves exercise capacity, functional status, dyspnea, fatigue, and quality of life. *Respiration*. 2022;101(6):593-601.
8. Abdelghani M, Hamed MG, Said A, Fouad E. Evaluation of perceived fears of COVID-19 virus infection and its relationship to health-related quality of life among patients with diabetes mellitus in Egypt during pandemic: a developing country single-center study. *Diabetology international*. 2022 Jan;13(1):108-16.
9. Terai H, Tamai K, Takahashi S, Hori Y, Iwamae M, Ohyama S, Yabu A, Hoshino M, Nakamura H. The health-related quality of life of patients with musculoskeletal disorders after the COVID-19 pandemic. *International orthopaedics*. 2022 Feb 1:1-7.
10. Ahmed I, Inam AB, Belli S, Ahmad J, Khalil W, Jafar MM. Effectiveness of aerobic exercise training program on cardio-respiratory fitness and quality of life in patients recovered from COVID-19. *European Journal of Physiotherapy*. 2022 Nov 2;24(6):358-63.
11. Onu I, Iordan DA, Matei D, Hrisca-Eva OD, Buculei I, Galaction AI, Serban IL, Dobrin ME, Popa-Velea O, Costin DE, Mocanu GD. Impact of Physiotherapy on Patients Suffering from COVID-19: An Observational Study. *Applied Sciences*. 2022 Jun 7;12(12):5795.
12. Groenveld T, Achttien R, Smits M, de Vries M, van Heerde R, Staal B, van Goor H, COVID Rehab Group. Feasibility of Virtual Reality Exercises at Home for Post-COVID-19 Condition: Cohort Study. *JMIR Rehabilitation and Assistive Technologies*. 2022 Aug 15;9(3):e36836
13. Andrade AD, Nepomuceno B, Xavier DS, Lima E, Gonzalez I, Santos JC, Esquivel MS, Novais MC, Magalhães P, Almeida RD, Gomes VA. Evidence-based physiotherapy and functionality in adult and pediatric patients with COVID-19. *Journal of Human Growth and Development*. 2020 Apr;30(1):148-55.

Table 1

DISTANCE	Experimental Group (n = 49)		Control Group (n = 47)	
	Experimental Mean	Experimental SD	Control Mean	Control SD
PRE	546.8	20.1	543.1	26.3





**Advita Neville Deepak et al.,**

<b>60DAYS</b>	652.3	25.1	562.7	29.5
<b>120 DAYS</b>	654.7	25.1	567.4	35.6
<b>F - Value</b>	702.508		43.455	
<b>p - value</b>	<0.001		<0.001	

**Table 2**

(I) Time		Experimental Group (n = 49)			Control Group (n = 47)		
		Mean Difference (I-J)	Std. Error	p - value	Mean Difference (I-J)	Std. Error	p - value
<b>Baseline</b>	<b>60 Day</b>	-16.455*	1.313	<0.001(HS)	-5.926*	0.834	<0.001(HS)
	<b>120 Day</b>	-17.991*	1.537	<0.001(HS)	-9.575*	1.417	<0.001(HS)
<b>60 Day</b>	<b>Baseline</b>	16.455*	1.313	<0.001(HS)	5.926*	0.834	<0.001(HS)
	<b>120 Day</b>	-1.536	1.010	0.135(NS)	-3.649*	1.737	0.041(S)
<b>120 Day</b>	<b>Baseline</b>	17.991*	1.537	<0.001(HS)	9.575*	1.417	<0.001(HS)
	<b>60 Day</b>	1.536	1.010	0.135(NS)	3.649*	1.737	0.041(S)

**Table 3**

VO2 MAX	Experimental Group (n = 49)		Control Group (n = 47)	
	Experimental Mean	Experimental SD	Control Mean	Control SD
<b>PRE</b>	28.8	4.2	29.9	3.2
<b>60DAYS</b>	35.1	4.1	31.0	3.3
<b>120 DAYS</b>	35.2	4.1	31.3	3.4
<b>F - Value</b>	702.508		43.455	
<b>p - value</b>	<0.001		<0.001	

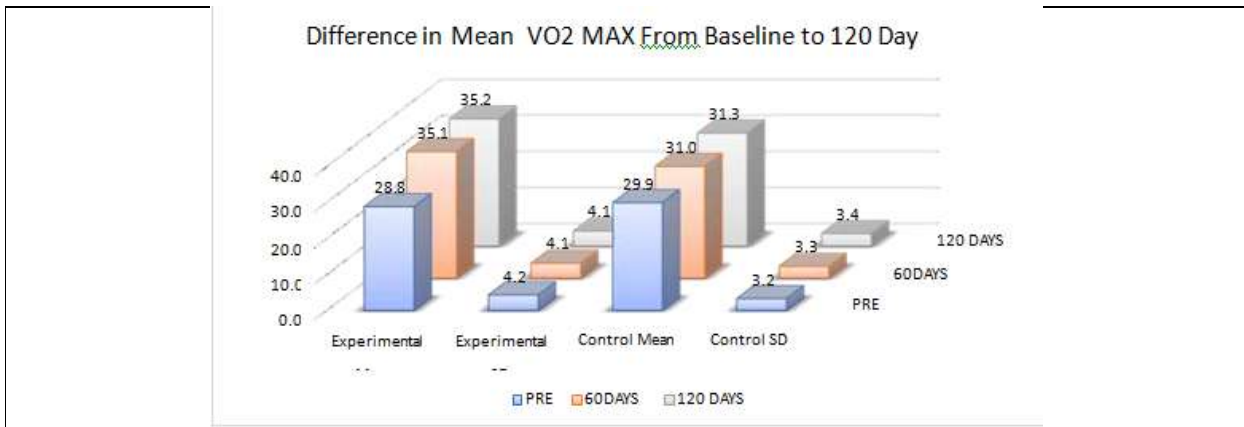
**Table 4**

(I) TIME	Experimental Group (n = 49)			Control Group (n = 47)			
		Mean Difference (I-J)	Std. Error	p - value	Mean Difference (I-J)	Std. Error	p - value
<b>Pre</b>	<b>60 DAYS</b>	-6.336*	0.239	<0.001(HS)	-1.172*	0.181	<0.001(HS)
	<b>120 DAYS</b>	-6.479*	0.240	<0.001(HS)	-1.458*	0.208	<0.001(HS)
<b>60 DAYS</b>	<b>PRE</b>	6.336*	0.239	<0.001(HS)	1.172*	0.181	<0.001(HS)
	<b>120 DAYS</b>	-.143*	0.051	0.007(S)	-.286*	0.082	0.001(S)
<b>120 DAYS</b>	<b>PRE</b>	6.479*	0.240	<0.001(HS)	1.458*	0.208	<0.001(HS)
	<b>60 DAYS</b>	.143*	0.051	0.007(S)	.286*	0.082	0.001(S)





**Advita Neville Deepak et al.,**



**Figure 1**





## Preliminary Phytochemical Screening and Evaluation of Antibacterial Activity of Different Fractional Extract of *Senna alexandrina* Flower

Samiran Sadhukhan<sup>1\*</sup>, Sawan Das<sup>2</sup>, Souradeep Mandal<sup>3</sup>, Sanjib Biswas<sup>3</sup> and Rupanjan Paul<sup>3</sup>

<sup>1</sup>Assistant Professor, Department of Pharmaceutical Chemistry, Netaji Shubas Chandra Bose Institute of Pharmacy, Nadia, (Affiliated to Maulana Abul Kalam Azad University of Technology), West Bengal India.

<sup>2</sup>Assistant Professor, Department of Pharmaceutics, Netaji Shubas Chandra Bose Institute of Pharmacy, Nadia, (Affiliated to Maulana Abul Kalam Azad University of Technology), West Bengal India.

<sup>3</sup>B.Pharm Student, Department of Pharmaceutical Chemistry, Netaji Shubas Chandra Bose Institute of Pharmacy, Nadia, (Affiliated to Maulana Abul Kalam Azad University of Technology), West Bengal India.

Received: 23 Jan 2024

Revised: 10 Apr 2024

Accepted: 10 May 2024

### \*Address for Correspondence

**Samiran Sadhukhan**

Assistant Professor,

Department of Pharmaceutical Chemistry,

Netaji Shubas Chandra Bose Institute of Pharmacy, Nadia,

(Affiliated to Maulana Abul Kalam Azad University of Technology),

West Bengal India.

Email: samiranrana05@gmail.com



This is an Open Access Journal / article distributed under the terms of the **Creative Commons Attribution License** (CC BY-NC-ND 3.0) which permits unrestricted use, distribution, and reproduction in any medium, provided the original work is properly cited. All rights reserved.

### ABSTRACT

This research aimed to investigate diverse secondary metabolites present in different fractional extracts (through polarity-dependent solvent extraction) of *Senna alexandrina* flower and to evaluate their antimicrobial activity against *Staphylococcus aureus* (MTCC 96) and *Pseudomonas aeruginosa* (MTCC 424). The outcome of preliminary phytochemical screening shows it had glycosides, tannins, and phenolic compounds; flavonoids were present in the chloroform fraction; alkaloids, glycosides, tannins, and phenolic compounds were in the chloroform-methanol fraction; and alkaloids, gums, mucilage, carbohydrates, steroids, and sterols were present in the aqueous fraction. The results of antimicrobial susceptibility testing reveal chloroform and water extract have promising antibacterial activity against *P. aeruginosa* as well as against *S. aureus*.

**Keywords:** Senna flower, secondary metabolite, solvent extraction, antimicrobial activity





Samiran Sadhukhan et al.,

## INTRODUCTION

Medicinal plants or medicinal herbs have been used in traditional medicine in many countries around the world since prehistoric times. Even now, it has crucial importance; about 80% of the world's population, including India, relies on medicinal herbs (Arora and Kaur, 2007). *Senna alexandrina*, commonly known as Indian senna, is a common plant grown in wastelands, well-drained sandy or laterite soil, roadside areas, and railway lines in the rural areas of West Bengal. The plant can grow up to 60–100 cm tall and is an annual. The colour of the stem is light green, and its woody stems are strongly branched. The leaf is winged with several leaflets, and the colour of the flower is bright yellow ("*Senna alexandrina* Mill," n.d.). The plant leaves have laxative activity, and they can be used to treat acute and chronic constipation. The fruits and leaves can also be applied for the treatment of epilepsy, dermatological disorders, respiratory diseases, skin infections, migraines, and heart diseases (Săvulescu et al., 2018). It is also used for ascites and dyspepsia. In unani medicine, it can be regarded as a blood purifier, anthelmintic, spasmodic, and emetic and used to treat periodic fevers, gout, and bronchial asthma (Akbar, 2020). Laxative potency was identical in mice, with 25% variation (Grote and Woods, 1944). There was no tolerance after repeated doses in weeks of administration (Woods and Grote, 1951).

Oral administration causes a cathartic response, while intraperitoneal injection of senna causes a minimal response at the same dose (Hazleton and Talbert, 1945). Pure sennosides primarily affect colonic motility after being degraded by colonic microorganisms (Garcia-Villar et al., 1980). Sennoside B has no or minimal effect on intestinal absorption in rats, and high doses decrease the net absorption of sodium, chloride, and water mainly in the colon and ileum; the jejunum does not change (Leng-Peschlow, 2011). The pods of this plant contain 2.5–4.5% sennosides, aloe emodin, anthraquinones, cathartic acid, cathartin, kaempferol, chrysophanic acid, rhein, isorhamnetin, emodin, mucilage, pheoretin, and senacrol, and the leaves contain free anthraquinones like aloe-emodin, chrysophanol, rhein, isorhamnetin, emodin, mucilage, pheoretin, and senacrol, and the leaves contain free sugars such as fructose, glucose, pinitol, sucrose, sucrose, etc. (Akbar, 2020). Polarity-based solvent extraction was way more advanced and scientifically significant than normal extraction through organic solvent. Different polarities and acid-base gradients shift several phytochemicals in different layers of solvent. Thus, it was comparatively easy to predict for which secondary metabolite we got significant therapeutic activity (Harborne, 1998). For assessment of antibacterial activity, we used one-gramme positive and one-gramme negative bacteria to predict the susceptibility or activity of different fractional extracts by determining the MIC through the broth dilution method and the zone of inhibition by the disc diffusion method.

## EXPERIMENTAL

### Plants material

Fresh plants of *Senna alexandrina* Mill were collected. After authentication, the plant materials (flower) were collected, washed with running tap water to remove attached dirt, and then washed with distilled water. The plant materials (flower) were then dried in the shade and separately pulverized in a mechanical grinder to obtain coarse powder.

### Preparation of flower extract

The shade dried 50 g of powdered plant material (flower) was taken into a 250 ml conical flask and extracted using methanol and water (4:1) using the ultrasonication-assisted maceration technique. They were kept overnight and sonicated for 30 minutes twice a day for up to 3 days. Care has been taken to prevent solvent loss during sonication. It was then filtered and centrifuged to remove the filtrate part. In the filtrate part, 2M H<sub>2</sub>SO<sub>4</sub> was added for acidification and extracted with chloroform three times in a separating funnel. The density of chloroform is higher than that of methanol, so it was settled in a down layer and separated from the chloroform extract in a beaker. The chloroform fraction is named fraction A. Then NH<sub>4</sub>OH was added to the aqueous acid layer to basify it to pH 10 and extracted with chloroform-methanol (3:1, twice) and chloroform (one time). Then the extract of chloroform and methanol was separated in a beaker, and the aqueous basic residue was collected in another beaker. Now the





Samiran Sadhukhan *et al.*,

chloroform-methanol fraction is named fraction B, and the aqueous layer is named fraction C. Then the extracts of chloroform, chloroform-methanol, and the aqueous basic layer were all dried and evaporated (Harborne, 1998).

#### Antimicrobial activity

A panel of two pathogenic bacterial strains, comprising *Pseudomonas aeruginosa* (Gram -ve) MTCC 424 and *Staphylococcus aureus* (Gram +ve) MTCC 96, were examined using chloroform extract and water extract. The strains were bought from the Institute of Microbial Technology in Sector 39, Chandigarh, India. A liquid broth medium will be prepared for MIC and bacterial culture growth and an agar medium for the zone of inhibition in order to evaluate the antimicrobial activity. 20 ml of liquid broth media will be taken into two test tubes (10 ml each) and added to a few drops of bacteria left in the BOD for 24 hours.

#### Broth dilution method

The broth dilution method was used to calculate the minimum inhibitory concentration (MIC). Five sterile test tubes are used for Gram + ve bacteria and five for Gram - ve bacteria when using chloroform or aqueous extract, respectively. For *Staphylococcus aureus* (GM + VE bacteria), concentrations of chloroform extract in the first test tube were 100 mg/ml, and dilutions were prepared using other test tubes containing 9 ml of liquid broth. The dilution factor is 10, and the concentrations of all extracts are 100 mg, 10 mg, 1 mg, 100 µg, and 10 µg /ml. Then, in laminar airflow, inoculate the bacteria with the help of a 100 micropipette and incubate at 37°C for 48 hours. This process will repeat for water extract and the standard drug vancomycin, but the concentrations of vancomycin are 100mg, 10mg, 1mg, 100µg, and 10µg. The extract concentration with the lowest MIC value and no discernible bacterial growth was noted (Lee et al., 2017).

#### Disc Diffusion Method

The disc diffusion method was used to identify the zone of inhibition. First of all, for both extracts, bacteria, and standard drugs 8 sterile Petri dishes are used, with four for gram-positive bacteria and four for gram-negative bacteria. The petri dish marks are one for chloroform extract, one for aqueous extract, one for standard drug, and one for all marks in a Y shape for both bacteria containing petri dishes. After that, in laminar air flow, take all the petri dishes to make a layer of agar media and wait until it is solid. On the other hand, take sterile paper discs (6 mm) and dip them in different solutions of extract and standard drug. The concentrations of extract and standard drug are 100 mg/ml and 50 mg/ml, respectively. After solidification of the agar media, spread the bacteria previously marked on the petri dish, and leave for 20 minutes. After that, put the different dipped paper discs in the previously marked area. Then the petri discs were incubated at 37°C for 24 hours. The antibacterial activity was measured as the mean diameter of the inhibition zones (cm) created by the extracts in triplicate for each test (Biemer, 1973).

## RESULT AND DISCUSSION

#### Preliminary phytochemical study

The results of preliminary phytochemical study of different fractional extract shown in table 1.

*Senna alexandrina* flower

#### Anti-microbial activity

##### Broth dilution method

The MIC of the *Senna alexandrina* flower's chloroform extract is 1000 µg/ml against *S. aureus* and 100 µg/ml against *P. aeruginosa*, whereas the MIC of the flower's aqueous extract is 100 µg/ml against *S. aureus* and 1000µg/ml against *P. aeruginosa*. Vancomycin, a common antibiotic, was effective against *S. aureus* and *P. aeruginosa* at 750µg/ml. Each organism's MIC value was calculated in triplicate. Fraction B did not show any significant anti-microbial activity.

##### Disc diffusion method

*S. aureus* (10.01 ± 3.48 cm<sup>2</sup>) and *P. aeruginosa* (9.88 ± 2.74 cm<sup>2</sup>) were both effectively eradicated by the chloroform extract. *S. aureus* (6.53 ± 2.03 cm<sup>2</sup>) and *P. aeruginosa* (7.74 ± 2.43 cm<sup>2</sup>) were both effectively eradicated by the aqueous

74202





Samiran Sadhukhan *et al.*,

extract. The same for the common medication (vancomycin) was discovered to be  $12.2 \pm 2.35$  mm and  $8 \pm 2.58$  mm against *S. aureus* and *P. aeruginosa*, respectively. Fraction B or chloroform-methanol fraction did not show any significant anti-microbial activity.

Note: The data from the control disc used for the solvent had no zone of inhibition, hence it was excluded from the results presented above. The paper disc's (6 mm) diameter is one of the inhibition zones. Results are presented as the mean  $\pm$ SEM of three replicate measurements.

Figure 1: Antibacterial activity of Chloroform and water extract of *Senna alexandrina* flower against tested bacterial strain

## CONCLUSION

*Senna alexandrina* flower extracts in chloroform and water demonstrated antimicrobial properties against every tested organism. Chloroform and water extract exhibit potential antibacterial action against both gramme positive bacteria *S. aureus* and gramme negative bacteria *P. aeruginosa*, according to the findings of an antimicrobial susceptibility test. The result obtained from antimicrobial activity of *Senna alexandrina* flower could consider this plant used as antimicrobial drug. On the other hand, fraction B did not show any significant anti-microbial activity. These results provide a support for the traditional uses of *Senna alexandrina* flower for fight against bacteria.

## ACKNOWLEDGEMENT

With most sincere and deepest sense of gratitude I remain greatly indebted to Professor (Dr.) Arnab Samanta, Principal and the management of this institute for their patience, constant encouragement, complete guidance, providing laboratory facilities and continuous help during this research work. Their valuable suggestions and timely advice were of immense help to me throughout all the phases of the study.

### Competing Interests

No Competing Interests. Both the author has equal contribution throughout this study.

## REFERENCES

1. Akbar, S., 2020. Handbook of 200 Medicinal Plants: A Comprehensive Review of Their Traditional Medical Uses and Scientific Justifications. Springer International Publishing, Cham. <https://doi.org/10.1007/978-3-030-16807-0>
2. Arora, D.S., Kaur, G.J., 2007. Antibacterial activity of some Indian medicinal plants. J Nat Med 61, 313–317. <https://doi.org/10.1007/s11418-007-0137-8>
3. Biemer, J.J., 1973. Antimicrobial Susceptibility Testing by the Kirby-Bauer Disc Diffusion Method. Ann Clin Lab Sci 3, 135–140.
4. Factors influencing the cathartic activity of senna in mice - Hazleton - 1945 - Journal of the American Pharmaceutical Association - Wiley Online Library [WWW Document], n.d. URL <https://onlinelibrary.wiley.com/doi/abs/10.1002/jps.3030341005> (accessed 6.5.23).
5. Garcia-Villar, R., Leng-Peschlow, E., Ruckebusch, Y., 1980. intestinal motility in canines and rats as a result of anthraquinone derivatives. Pharmacy and Pharmacology Journal 32, 323-329. <https://doi.org/10.1111/j.2042-7158.1980.tb12929.x>
6. Harborne, A.J., 1998. Phytochemical Methods A Guide to Modern Techniques of Plant Analysis. Springer Science & Business Media.
7. Grote, I.W., Woods, M., 1944. Laxative action in mice of tinnevelly and alexandria senna, and of several botanically related plants. J. Am. Pharm. Assoc. 33, 266–270. <https://doi.org/10.1002/jps.3030330803>
8. Woods, M., Grote, I.W., 1951. A study of the repeated administration of tinnevelly and alexandria Senna to mice. J. Am. Pharm. Assoc. 40, 198–202. <https://doi.org/10.1002/jps.3030400409>







**Samiran Sadhukhan et al.,**

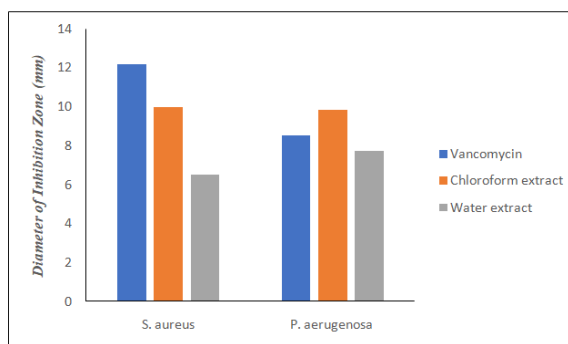
9. Lee, W.-B., Fu, C.-Y., Chang, W.-H., You, H.-L., Wang, C.-H., Lee, M.S., Lee, G.-B., 2017. A microfluidic device for antimicrobial susceptibility testing based on a broth dilution method. *Biosensors and Bioelectronics* 87, 669–678. <https://doi.org/10.1016/j.bios.2016.09.008>
10. Leng-Peschlow, E., 2011. Senna derivatives inhibit the absorption of intestinal water and electrolytes in rats. *Pharmacy and Pharmacology Journal* 32, 330-335. <https://doi.org/10.1111/j.2042-7158.1980.tb12930.x>
11. Luchian, V., Popa, V., Georgescu, M., and Săvulescu, E., 2018. Cassia angustifolia Vahl.'s *Senna alexandrina* Mill. : Morphological and Anatomical Properties. "Agriculture for Life Life for Agriculture" Conference Proceedings 1, 305–310. <https://doi.org/10.2478/alife-2018-0045>
12. *Senna alexandrina* Mill - GlobinMed [WWW Document], n.d. URL [https://globinmed.com/medicinal\\_herbs/senna-alexandrina-mill/](https://globinmed.com/medicinal_herbs/senna-alexandrina-mill/) (accessed 6.5.23).

**Table 1: Results of Preliminary phytochemical screening of different fractional extract of Senna alexandrina flower**

1. Crude extract (Methanol-Water)	Alkaloid, glycosides, flavonoids, tannins and phenolic compounds, gums and mucilage, carbohydrate.
2. Chloroform fraction (A)	Glycosides, tannin, phenolic compounds, flavonoids.
3. Chloroform- methanol fraction (B)	Alkaloids, glycosides, tannins, phenolic compounds, steroids.
4. Aqueous fraction (C)	Alkaloids, gums and mucilage, carbohydrates steroids and sterols.

**Table 1: Result of Antibacterial activity of Chloroform and water extract of Senna Alexandrina flower against tested bacterial strain**

Microorganisms	Diameter of inhibition zone (mm)			MIC (µg/ml)		
	Chloroform extract	Water extract	Vancomycin	Chloroform extract	Water extract	Vancomycin
<i>S. aureus</i>	10.01±3.48	6.53±2.03	12.2±2.35	1,000	100	750
<i>P. aeruginosa</i>	9.88±2.74	7.74±2.43	8±2.58	100	1000	500



**Figure 1: Antibacterial activity of Chloroform and water extract of Senna Alexandrina flower against tested bacterial strain**





## Navigating the Regulatory Landscape: Unraveling the Rules on Misleading Drug Advertisements in the USA

Illa Amrutha Rajeswari<sup>1\*</sup>, Palavi Vadlamudi<sup>2</sup> and Koushik Yetukuri<sup>3</sup>

<sup>1</sup>Master of Pharmacy Student, Department of Regulatory Affairs, Chalapathi Institute of Pharmaceutical Sciences (Affiliated to Acharya Nagarjuna University) Lam, Guntur, Andhra Pradesh, India.

<sup>2</sup>Professor, Department of Pharmaceutics, Chalapathi Institute of Pharmaceutical Sciences (Affiliated to Acharya Nagarjuna University) Lam, Guntur, Andhra Pradesh, India.

<sup>3</sup>Associate Professor, Department of Pharmaceutical Regulatory Affairs, Chalapathi Institute of Pharmaceutical Sciences (Affiliated to Acharya Nagarjuna University) Lam, Guntur, Andhra Pradesh, India.

Received: 06 Jan 2024

Revised: 09 Feb 2024

Accepted: 29 Apr 2024

### \*Address for Correspondence

**Illa Amrutha Rajeswari**

Master of Pharmacy Student,  
Department of Regulatory Affairs,  
Chalapathi Institute of Pharmaceutical Sciences  
(Affiliated to Acharya Nagarjuna University) Lam,  
Guntur, Andhra Pradesh, India.  
Email: amrutharajeswari1999@gmail.com



This is an Open Access Journal / article distributed under the terms of the **Creative Commons Attribution License** (CC BY-NC-ND 3.0) which permits unrestricted use, distribution, and reproduction in any medium, provided the original work is properly cited. All rights reserved.

### ABSTRACT

FDA mandates pre-approval scrutiny for pharmaceutical products, assessing various production sites. After approval, risk-based surveillance inspections occur. A study examines warning letters from FDA's FTC (federal trade commission) and OPDP (office of prescription drug promotion) to drug firms' post-approval, delving into reasons behind such regulatory actions for enhanced pharmaceutical industry compliance and public safety. Advertisements are vital in a community where all companies fight for development and economic success. Drug development is a time-consuming and risky business. Marketing has a huge positive impact on the introduction of new products to the market. However, several pharmaceutical goods marketing specifically branded products are disputed and in violation of advertising regulations. This study investigates the regulatory environment of pharmaceutical advertising by analyzing warning letters (WL) issued by the FTC and OPDP between 2017 and 2023. The study focuses on the reasons underlying regulatory actions for improved industry compliance and public safety by examining FDA-mandated pre-approval scrutiny and post-approval surveillance inspections. Over a decade, advertising has been a crucial tool for any industry in reaching out to new clients while preserving confidence with existing ones. Pharmaceutical advertising, from a regulatory standpoint, is far more than just advertising in the traditional sense. Each country has its own legislative





Illa Amrutha Rajeswari et al.,

framework in place to protect the interests of consumers and corporations. This study emphasizes the overall regulatory consequences of misleading advertisements of drugs with respect to warning letters issued by both FTC and OPDP in USA.

**Keywords:** Federal trade commission, office of prescription drug promotion, food drug administration, warning letters

## INTRODUCTION

Advertisement serves as a communication modality employed to disseminate information pertaining to a product or service within a market. Its primary objective is to enhance the visibility and market penetration of a product or service, especially when introducing a newly launched offering. In the context of a burgeoning consumerist culture in the contemporary corporate landscape, advertisements assume a pivotal role in shaping and influencing consumer behaviors. Advertisement functions as a means to apprise the general public of a seller's product, service, or idea within the market. This informational outreach is designed to stimulate consumer interest and encourage the purchase of the promoted product or service. It serves as a conduit through which manufacturers or sellers communicate essential details regarding the nature, quality, and characteristics of a specific product or service they offer in the marketplace. However, it is noteworthy that, instead of solely providing factual information, advertisements occasionally manifest as a form of disinformation, potentially misleading consumers about the attributes of the advertised product, service, or idea[1]. The FDA and FTC jointly regulate pharmaceutical advertising in the United States to ensure accuracy and prevent deception. The FDA reviews and approves prescription drug promotional materials, scrutinizing their content for truthfulness and balance. Monitoring activities help identify and address misleading practices. The FTC collaborates with the FDA to combat deceptive advertising, ensuring claims are substantiated. Violations may result in warnings, fines, or corrective advertising. Congressional regulations classify pharmaceuticals as prescription or non-prescription drugs, with the FDA overseeing the advertising of prescription drugs, enforcing rules to maintain integrity and transparency in the pharmaceutical market.[2] The misleading advertisements may occur in different ways those can be seen in fig:1

### The following are examples of misleading advertising

1. oversimplifying and exaggerating;
2. expressing unrealistic features of the product;
3. applying professional notions for greater effect;
4. presenting false licenses; providing false guarantees;
5. utilizing deceptive visuals and cinematic strategies;
6. offering discounts and free stuff [3].

The FDA operates as a traditional regulatory body, employing administrative procedures to form conclusions, potentially leading the Commissioner to restrict advertising. FDA warning letters are official notices issued to entities violating federal regulations on product safety and efficacy. These letters detail infractions, specify broken rules, and request corrective actions. Recipients must respond in writing, outlining steps taken to rectify violations and prevent recurrence. This regulatory approach underscores the FDA's commitment to ensuring compliance with rigorous standards, promoting the safety and effectiveness of products in the United States through a systematic process of assessment, communication, and enforcement[4]. FDA warning letters investigate deceptive claims about safety and efficacy in the pharmaceutical and medical device sectors. Deviations promote corrective measures, emphasizing sound manufacturing procedures. Threats of adulteration and contamination necessitate vigilance to ensure product integrity and public trust. Medical device warnings emphasize pre-market approval and regulatory compliance, but failure to disclose adverse occurrences prompts FDA intervention for proactive risk reduction. Labelling and advertising breaches highlight the significance of correct information for consumers and





Illa Amrutha Rajeswari et al.,

healthcare professionals to make educated decisions[5]. The Office of Prescription Drug Promotion (OPDP) is critical in ensuring that prescription medicine advertising is accurate. OPDP attempts to ensure true, balanced, and accurate information in promotional materials by constant monitoring, conformance checks, studies, and training programmers. OPDP's research, which employs a variety of techniques, contributes to the FDA's science-based policy goals while maintaining a commitment to public health. The OPDP research team also works with outside organizations to plan and carry out drug promotion studies. OPDP reviewers are responsible for analyzing promotional materials, offering input to sponsors, resolving complaints, initiating compliance actions, and ensuring compliance with prescription drug promotion rules and regulations [6].

## METHODOLOGY

A complete dataset encompassing FDA-FTC-OPDP warning letters branded Misleading Advertisements or Violation of Law, spanning the years 2017 to 2023, was painstakingly obtained from the official FDA website. The extraction, organization, and categorization of pertinent information necessitated meticulous extraction, organization, and categorization, ensuring a scientific approach to data retrieval and administration. This well-organized information provides for in-depth analysis and research on changes, patterns, and regulatory enforcement actions throughout the specified time period. The methodological rigor with which this dataset was compiled boosts its dependability and utility for scientific investigations of the regulatory environment of pharmaceutical advertising and law compliance over the chosen time period. The USFDA works with the FTC and the OPDP to regulate pharmaceutical advertising in order to ensure honesty and prevent deceit. Their primary goal is to provide patients with accurate information regarding product advantages and hazards. When businesses break advertising regulations, they are issued warning letters and fines, including product recalls. The Phra, an IFPMA-accredited organisation, establishes guidelines for pharmaceutical marketing in the United States, assuring accurate and consumer-protective procedures in accordance with industry standards. In the mid-1980s, pharmaceutical information was limited to healthcare professionals, with no rule against direct-to-consumer (DTC) advertising. The inaugural DTC ad in 1981 for Merck's Pneumovax VR marked a shift. DTC ads were permitted in 1997, regulated by the FDA under laws like 21 CFR 202.20. The Office of Prescription Drug Promotion (OPDP) oversees prescription medication advertising. The FDA investigates professional ads through various channels, categorizing marketing initiatives into three groups for effective oversight [7]. In USA drug advertising and marketing, products are classified into three types: Direct-to-Consumer (DTC), Healthcare Professional (HCP), and Business-to-Business (B2B). The responsible agencies vary for each type, with the FDA and FTC overseeing DTC, the FDA and OPDP managing HCP, and the FDA and PhMRA handling B2B communications. Which is clearly described (table: -1 and table: - 2)

### Advertising approval process in the USA

In the USA, mandatory approval for promotional and labeling materials is required for prescription products. Surveillance of pharmaceutical advertising is vital for consumer protection and accurate information for healthcare professionals. The Office of Prescription Drug Promotion (OPDP) and Federal trade commission FTC meticulously reviews prescription drug advertising and labeling to ensure accuracy and prevent deception. Agencies are urged to substantiate claims with verified evidence. The OPDP and FTC under the FDA's CDRH, initiated the Bad Ad Program in 2010, aiming to heighten awareness about false advertising to healthcare professionals and encourage reporting of deceptive advertising and labeling materials, promoting transparency and integrity in pharmaceutical marketing. Which is clearly described in (figure: -2) The examination focuses on assessing the bank's adherence to Section 5 of the FTC Act, which prohibits unfair or deceptive acts. Examination procedures involve evaluating internal policies, controls, and procedures to ensure compliance. Specific areas of scrutiny include compliance management systems, advertising, disclosures, servicing, collections, and employee and third-party oversight related to potential areas of concern. Inspectors should utilize these procedures along with best practices to identify unfair or deceptive practices. Supervisors, as needed, should review past examination records, safety-and-soundness reports, compliance with Regulation AA, internal policies, and sample customer materials. Interviews





Illa Amrutha Rajeswari *et al.*,

with management and staff aim to discuss concerns and ensure regulatory compliance. which is clearly described in (figure: -3) In both the FTC and OPDP warning letters, data analysis found significant advertising breaches. Misleading statements, insufficient proof, and noncompliance with regulatory rules were all common themes. Identifying these primary areas informs targeted initiatives in the pharmaceutical and consumer goods sectors to improve conformity to advertising standards and protect consumer interests.

## RESULTS AND DISCUSSION

### Results

In 2017, the FTC and OPDP issued four warning letters together in response to deceptive pharmaceutical advertisements. This joint approach demonstrated a purposeful dedication to transparency and integrity in promotional materials. Regulatory vigilance increased in 2018, with a total of ten warning letters, indicating a greater commitment to ensuring information accuracy. The apex happened in 2019, with 19 warnings and an emphasis on a collaborative effort to correct deceptive advertising in healthcare. Following years witnessed a consistent regulatory presence, with 17 warnings in 2020 and 19 in 2021. 15 warning letters maintained the pattern in 2022, and joint efforts continued in 2023 with 8 warnings. These scientific findings highlight the FTC and OPDP's continuous commitment to addressing and mitigating the effects of misleading advertisements, showcasing the evolving and proactive nature of pharmaceutical oversight over the specified years.(Figure:4) The Federal Trade Commission (FTC) and Office for prescription drug promotion systematically documented the fluctuations in warning letters (WL) regarding misleading advertisements percentages relevant to various procedures throughout the course of the analyzed years. In the first year, 2017, a thorough investigation found that one methodological technique resulted in a 3.3%, while another way resulted in a 6.2% of warning letters by FTC and OPDP. Moving forward to the next year, 2018, both approaches saw an incremental increase, with the percentages rising to 8.3% and 15.6%, respectively. The year 2019 saw a noticeable increase in warning letters percentages, with one technique revealing a considerable 20.0% drop and the other revealing a strong 21.8% reduction. In 2020, regulatory action increased significantly, with warning letters accounting for 18.2% of one category and 18.7% of OPDP, demonstrating a dedication to compliance. This pattern continued in 2021, with the FTC issuing warnings at 21.6% and 18.7%, respectively. By 2022, there was a noticeable change, with warning letters dropping to 18.2% and 12.5%, respectively. In 2023, the percentages fell to 10.0% and 6.25%, indicating a more sophisticated regulatory strategy or increased industry compliance. Scientific data highlight FTC and OPDP's dynamic functioning, demonstrating flexibility and targeted treatments. The FTC also filed charges against firms for breaking advertising regulations. (Figure :5)

## DISCUSSION

Analysis of warning letters highlights pivotal factors contributing to drug advertising misguidance. This study substantiates the primary reasons behind misleading promotions, offering crucial insights for regulatory improvements. Understanding the major regions of concern is essential for fostering transparent and accurate pharmaceutical advertising practices, ensuring public safety and awareness. In most of the cases the misleading advertisements happens for not following the exact sections and in both FTC and OPDP. Information and data Misleading ads are mostly the result of noncompliance with specified regulations, most notably Section 5 of the Federal Trade Commission (FTC). Pharmaceutical businesses frequently violate this rule by failing to maintain fair and honest procedures. Adherence to Section 5 is critical to resolving the widespread problem of deceptive pharmaceutical ads. The FTC is authorized by Section 5 of the Federal Trade Commission Act, 15 U.S.C. § 45, to look into and stop misleading business practices. The legislation states that "unfair methods of competition in or affecting commerce, and unfair or deceptive acts or practices in or affecting commerce, are hereby declared unlawful." The FTC has separate enforcement and authority over two different types of consumer deception: unfairness and unfairness. The FTC is also in charge of investigating unfair corporate competition practices Section



**Illa Amrutha Rajeswari et al.,**

5 of the Federal Trade Commission Act (FTC Act) prohibits "unfair or deceptive acts or practices in or affecting commerce" (15 USC 45). This applies universally, encompassing entities like financial institutions. The Board can address such conduct under Section 8 of the Federal Deposit Insurance Act. A joint statement by the Board and Federal Deposit Insurance Corporation, issued on March 11, 2004, delineates responsibilities regarding unfair or deceptive activities in state-chartered banks. The statement outlines legal requirements, risk administration, and provides recommendations, including best practices, to prevent unfair or deceptive acts and practices in state-chartered banks.[8] Six of OPDP's letters accused fraudulent or misleading risk presentation (one letter charged "false or misleading risk and benefit presentations"). Three letters accused fraudulent or misleading statements regarding effectiveness or benefit (including the letter alleging "false or misleading claims about efficacy or benefit"). fraudulent or misleading risk and benefit presentations," a letter alleging "false or misleading effectiveness claims," and a letter alleging "false or misleading benefit presentation"). One letter complained about the absence of crucial details. In addition to one or more of the charges outlined above, all three letters concerning DTC product endorsements accused failure to submit promotional material to OPDP under Form FDA-2253.[9]

**False or Misleading Risk Presentation**

The referenced promotional material provided inaccurate or misleading risk information, according to five of the six letters sent in 2021, including both warning letters and all three letters concerning DTC product endorsements. OPDP claimed in three such letters that the advertising materials lacked "any risk information." OPDP admitted in a warning letter to Cooper Surgical, Inc. (CSI) that a promotional video containing a physician interview directed viewers to the PARAGARD® (intrauterine copper contraception) website for further information about the device. However, OPDP determined that "this does not mitigate the video's complete omission of risk information." [9]

**False or Misleading Claims About Efficacy or Benefit**

The FDA's Office of Prescription medicine Promotion (OPDP) issued a warning letter on August 4, 2023, aimed at a sales aid for a medicine authorized for the maintenance treatment of patients with chronic obstructive pulmonary disease (COPD).<sup>1</sup> On August 15, 2023, the FDA issued the letter. this violation was cited if the information presented in the advertisement directly or indirectly contradicted package insert or full prescribing information. For example, if the drug had potentially serious adverse effects and the advertisement claimed the drug to be safe, then this violation was cited in letters. Some advertisements claimed that the drug had expanded access (for compassionate use) while the approval for expanded access had not been granted by the FDA. In this case, the advertisement was cited for a false and misleading claim. This was considered as violation of 21 CFR 312.300, 21 CFR 202.1(e)(3)(iii). Many stakeholders have highlighted that OPDP enforcement of drug promotion standards have been at a lengthy halt in recent years.<sup>2</sup> For example, in 2022, OPDP issued only four enforcement letters, with none issued for nearly a year between June 2, 2022, and June 7, 2023.

OPDP has now issued two letters in less than two months, including its first warning letter since February 2022. If present trends continue, the OPDP may soon approach enforcement levels last seen in 2019. In 2023 The US Food and Drug Administration's (FDA) Office of Prescription Drug Promotion (OPDP) reviewed a promotional communication, a professional sales aid (US-68433), for BREZTRI AEROSPHERE™ (budesonide, glycopyrrolate, and formoterol fumarate) inhalation aerosol, for oral inhalation use (BREZTRI) submitted by AstraZeneca under the cover of Form FDA 2253. The sales tool makes false or misleading claims and/or representations about BREZTRI'S effectiveness. Thus, the sales assistance misbrands BREZTRI in violation of the Federal Food, Drug, and Cosmetic Act (FD&C Act), making its distribution illegal. 21 U.S.C. 352(a); 331(a). Observe 21 CFR 202.1(e)(5). These infractions are significant from the standpoint of public health since the promotional communication provides a false impression about the overall advantages that a patient may expect as a consequence of the treatment. BREZTRI treatment. [10] In 2021 FTC send 13 warning letters to different companies one of that is NeiMed Pharmaceuticals For unlawfully advertising that your nasal irrigation products treat or prevent Coronavirus Disease 2019 (COVID-19). On August 18, 2020, Neimed pharmaceuticals declare on Facebook and Instagram: "Benefits and Safety of Nasal Saline Irrigations in a Pandemic—Washing COVID-19 Away." Under the FTC Act, 15





Illa Amrutha Rajeswari *et al.*,

U.S.C. 41 et seq., it is illegal to advertise that a product may prevent, treat, or cure human illness unless you have competent and reliable scientific data substantiating the claims at the time they are made. There is presently no such study for COVID-19 for the goods listed above. As a result, any coronavirus-related preventative or treatment claims made about such items are unsubstantiated by competent and credible scientific data. Violations of the FTC Act may result in legal action seeking a Federal District Court injunction, including an order requiring you to repay money to customers. Furthermore, marketers who make deceptive claims about the treatment, cure, prevention, or mitigation of COVID-19 are subject to a civil penalty of up to \$43,792 per violation under the COVID-19 Consumer Protection Act, Section 1401, Division FF, of the Consolidated Appropriations Act, 2021, P.L. 116-260<sup>[11]</sup> For more enforcement [11]

## ACKNOWLEDGEMENTS

I am thankful to Chalapathi institute of pharmaceutical sciences for the continuous support and Mr. Koushik Yetukuri who supported and guided for the completion of this article work.

## CONCLUSION

In conclusion, the collaborative efforts of the Federal Trade Commission (FTC) and the Office of Prescription Drug Promotion (OPDP) were evident through a systematic issuance of warning letters, showcasing a commitment to regulatory diligence and transparency in healthcare communication. The escalating warnings from 2017 to 2019 signaled heightened vigilance. Subsequent years revealed sustained focus with nuanced regulatory shifts. The declining trend in warnings by 2023 suggests refined strategies or improved compliance. These scientific observations emphasize the dynamic nature of pharmaceutical oversight, underscoring regulatory bodies' dedication to evolving interventions and preserving healthcare information integrity. The FTC's legal actions underscore a comprehensive approach to enforcing laws on misleading advertisements.

## REFERENCES

1. Introduction to misleading advertisements. <https://lawcorner.in/false-or-misleading-advertisements-under-consumer-protection-act-2019/>
2. <https://www.fda.gov/drugs/prescription-drug-advertising/basics-drug-ads>
3. <https://www.mygov.in/frontendgeneral/pdf/brief-on-misleading-advertisement.pdf>
4. Prescription drug Advertising: [https://www.fda.gov/drugs/prescription-drug-advertising/prescription-drug-advertising-questions-and-answers#law\\_violation\\_how](https://www.fda.gov/drugs/prescription-drug-advertising/prescription-drug-advertising-questions-and-answers#law_violation_how)
5. <https://www.fcc.gov/consumers/guides/complaints-about-broadcast-advertising>
6. <https://www.fda.gov/about-fda/center-drug-evaluation-and-research-cder/office-prescription-drug-promotion-opdp>
7. <https://journals.sagepub.com/doi/10.1177/17411343211005093>
8. Vikas Budhwar<sup>1</sup>, Tarif Hussian<sup>1</sup>, Manjusha Choudhary<sup>2</sup> and Garima Saini<sup>1</sup> Regulatory scenario of pharmaceutical advertisement in India, USA and Australia: A comparative study: <https://journals.sagepub.com/doi/pdf/10.1177/17411343211005093>
9. Scott cunningham<sup>1</sup>, Scott D. Danzis<sup>2</sup>, Stefanie A. Doebler<sup>3</sup>, 2021 End-of-Year Summary of FDA Advertising and Promotion Enforcement Activity: <https://www.cov.com/en/news-and-insights/insights/2022/02/2021-end-of-year-summary-of-fda-advertising-and-promotion-enforcement-activity>
10. <https://www.fda.gov/inspections-compliance-enforcement-and-criminal-investigations/warning->





**Illa Amrutha Rajeswari et al.,**

- letters/astrazeneca-pharmaceuticals-lp-664789-08042023
11. [https://www.ftc.gov/legal-library/browse/cases-proceedings?search=pharmaceuticals%20%20misleading%20advertisements%20&sort\\_by=search\\_api\\_relevance&page=0](https://www.ftc.gov/legal-library/browse/cases-proceedings?search=pharmaceuticals%20%20misleading%20advertisements%20&sort_by=search_api_relevance&page=0)

**TABLE1: type of advertisements and its description with responsible agency**

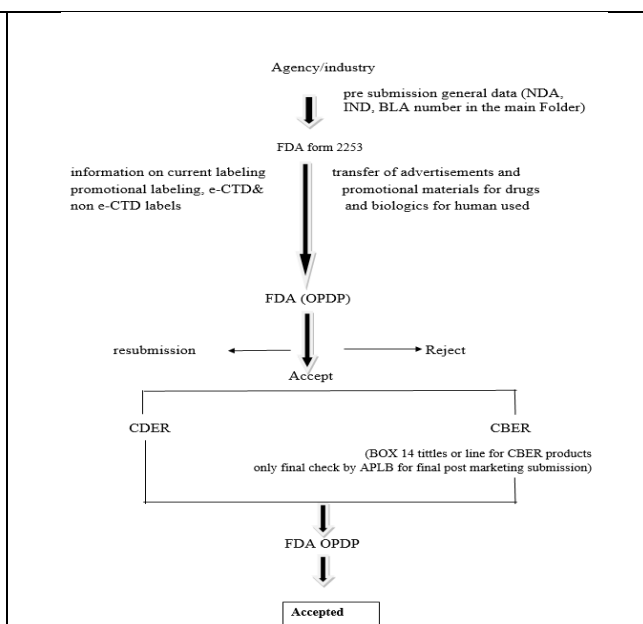
Type of Advertisement	Description	Responsible Agency
Direct to Consumers	Targets general public, promoting prescription drugs directly to consumers	FDA and FTC
Healthcare professionals	Aimed at medical professionals, providing detailed information on prescription drugs.	FDA and OPDP
Business to Business	Targeted at industry stakeholders, involving collaborations, conferences, and negotiations.	FDA

**TABEL 2: Regulatory Oversight by Category**

s.no	category	Prescription drugs& Biologics	Restricted devices	OTC drugs	Un restricted devices	Dietary supplements	Cosmetics
1	Labeling	FDA, OPDP	FDA	FDA	FDA	FDA	FDA
2	Advertising	FDA, OPDP	FDA	FTC	FTC	FTC	FTC
3	internet	FDA, OPDP	FDA&FTC	FDA	FDA&FTC	FDA	FDA



**Figure 1: Occurrence of Misleading Advertisements"**



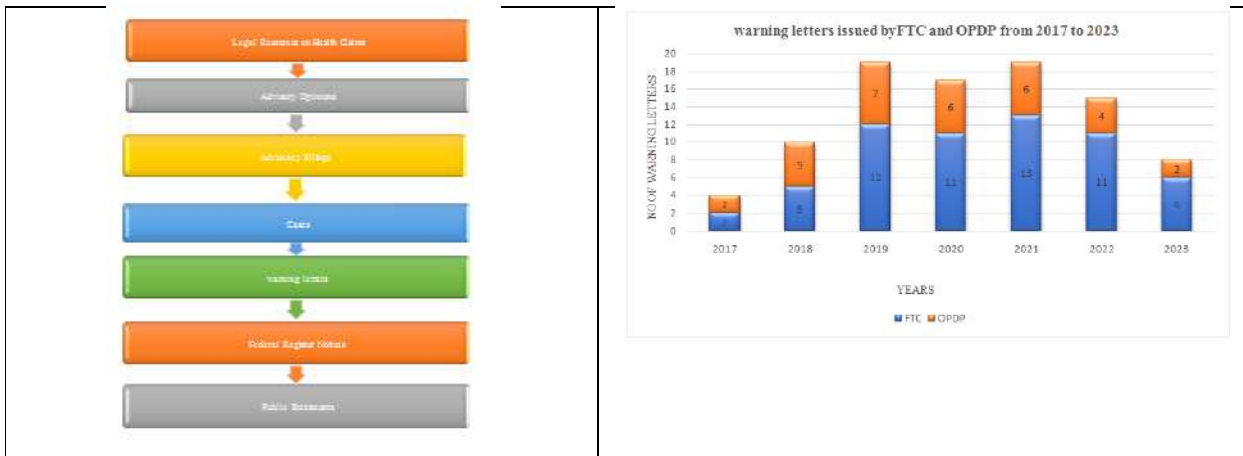
**Figure2: process of promotion acceptance by OPDP**





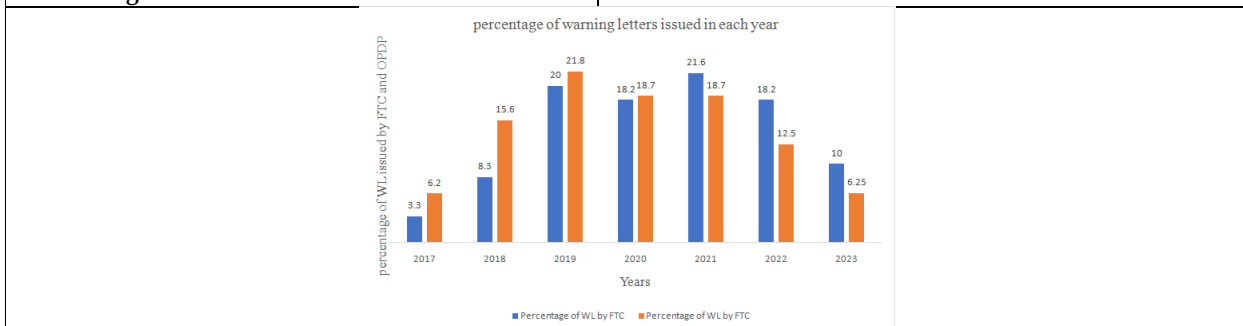


**Illa Amrutha Rajeswari et al.,**



**Figure3: case filing process of FTC in case of misleading Advertisements**

**Figure 4: warning letters issued by FTC and OPDP from 2017 to 2023**



**Figure 5: percentage of warning letters issued in each year**





## Consumer Behavior in the Digital Age: A Review of Trends and Strategies in E-Commerce

Varanasi Rahul\*, Vainik V S, Deepak D and Sathyanarayana N

Assistant Professor, Department of Commerce, JAIN (Deemed to be University), Bengaluru, Karnataka, India.

Received: 22 Jan 2024

Revised: 09 Feb 2024

Accepted: 13 May 2024

### \*Address for Correspondence

#### Varanasi Rahul

Assistant Professor,  
Department of Commerce,  
JAIN (Deemed to be University),  
Bengaluru, Karnataka, India.  
Email: vainika840@gmail.com



This is an Open Access Journal / article distributed under the terms of the **Creative Commons Attribution License** (CC BY-NC-ND 3.0) which permits unrestricted use, distribution, and reproduction in any medium, provided the original work is properly cited. All rights reserved.

### ABSTRACT

Consumer behavior within the computerized age has seen a critical change due to the far reaching appropriation of innovation and the development of e-commerce stages. This review paper points to supply an diagram of the current patterns and techniques in e-commerce that impact customer behavior. By analyzing the writing and observational thinks about, this paper identifies key components that shape shopper behavior within the advanced age, counting the move towards online shopping, the rise of versatile commerce (m-commerce), personalization and customization, the impact of social media, and the affect of user-generated substance and online audits. In addition, it investigates different techniques utilized by e-commerce businesses to impact customer behavior, such as client encounter (UX) plan, personalized promoting, social media promoting, client relationship administration (CRM), and information analytics. Additionally, this paper highlights the challenges and moral contemplations that emerge within the consider of buyer behavior, counting protection concerns, online tricks, and the moral suggestions of targeted advertising and behavioral following. The suggestions for businesses and e-commerce stages are talked about, emphasizing the ought to get it and adjust to the changing shopper behavior scene. Moreover, this paper distinguishes openings for future investigate in buyer behavior and e-commerce, giving bits of knowledge into potential headings for understanding and successfully catering to consumer needs and inclinations within the computerized age.

**Keywords:** Customer behavior, Digital age, E-commerce, Patterns, Techniques, Online shopping, Versatile commerce, Personalization, Social media promoting, User-generated substance, Client involvement, Information analytics, Protection concerns.



Varanasi Rahul *et al.*,

## INTRODUCTION

Consumer behavior within the computerized age has been essentially affected by the progressions in computerized innovation [1]. The expanded get to to data and the comfort of online shopping have driven to changes in shopping behavior and a move towards e-commerce stages [2]. Social media plays a pivotal part in forming buyer inclinations and making modern patterns [3]. The nonstop advancement of data and communication innovations has driven to a critical increment in e-commerce exchanges and the utilize of advanced instruments such as social media, counterfeit insights, and the Web of Things [4]. The advanced period has engaged buyers by giving them with simple get to to data, the capacity to compare and differentiate between brands, and the opportunity to share their post-purchase information and encounters [5]. These changes have moreover brought about within the development of unused models of shopper behavior forms, such as the ROPO impact (Investigate Online, Buy Offline) and the switch ROPO (Investigate Offline, Buy Online)

### Significance of understanding consumer behavior in e-commerce

Understanding customer behavior in e-commerce is noteworthy for a few reasons. Firstly, it permits for a more profound understanding of client route on e-commerce websites and its impacts on obtaining choices [6]. Besides, it makes a difference in analyzing the components that impact item buy purposeful, such as electronic word-of-mouth, customer rating, and notoriety [7]. Thirdly, it empowers a comprehensive investigation of different components that influence buyer behavior, counting shopper environment, buyer request, and other variables like transportation coordinations and promoting [8]. Moreover, considering shopper behavior in e-commerce makes a difference in anticipating and foreseeing client obtaining practices, driving to more incomes and remaining ahead within the advertise [9]. Finally, it helps in settling natural issues by recognizing components that influence green customer buy choices on social commerce stages [10]. In general, understanding buyer behavior in e-commerce is pivotal for planning viable promoting techniques, progressing site plan, and advancing maintainable hones.

### Purpose of the review paper of Consumer Behaviour

The Reason of the audit of customer behavior within the computerized age is to get it the patterns and procedures in e-commerce [11]. The survey points to classify online buyer behavior in an dubious situation, utilizing the self-determination hypothesis and essential mental needs [12]. It moreover explores the components that influence buyer behavior in e-commerce, such as customer environment, buyer request, and different other variables [13]. The audit recognizes the determinants of online shopper behavior, counting components like seen convenience, seen chance, demeanor, believe, social impact, and statistic variables [14]. Moreover, the survey investigates the investigation of shopper behavior in online shopping, centering on recognizing customers, their acquiring behavior, and their requirements for future points [15]. The survey points to supply experiences for online retail supervisors and professionals to upgrade esteem within the electronic setting for both clients and firms

### Overview of Consumer Behavior in E-commerce

#### Definition of consumer behavior

Consumer behavior refers to the variables that impact how customers purchase and utilize items or administrations. These components incorporate the consumer's common and contract environment, socio statistic and psychographic components, natural variables, and situational variables. Culture is an imperative portion of the consumer's common environment. There are two distinctive approaches to shopper inquire about: explanatory buyer inquire about and interpretive shopper investigate. The explanatory approach, spoken to by cross-cultural shopper investigate (CCCB), is taken after in this book [16]. To totally depict an individual's behavior, their choices for each choice issue they may confront have to be indicated. Not each subset of options may be a choice problem for a customer. The behavior of a buyer who faces a budget set, which could be a specific sort of choice issue, is centered on in this chapter [17]. The consider of buyer behavior is intrigue, drawing from disciplines such as financial matters, brain research, human science, and neurosciences. Understanding buyer behavior can advantage marketers, policymakers, customer





Varanasi Rahul *et al.*,

advocates, and shoppers themselves [18]. The concept of buyer behavior has different translations and definitions, but it by and large alludes to the discernments of propensities, ways of life, states of mind, and honos of customers [19].

#### **Factors influencing consumer behavior in the digital age**

Shopper behavior within the computerized age is impacted by different components. The affect of advanced innovative propels on customer designs in urban society has been watched, with expanded get to to data and the comfort of online shopping driving to changes in shopping behavior and a move towards e-commerce platforms [20]. Be that as it may, there's frequently an irregularity between individuals' concerns approximately moral or natural issues and their real utilization behavior, which can be credited to cognitive, social, and natural impacts [21]. Influencers within the computerized age play a critical part in forming buyer inclinations and making unused patterns, in spite of the fact that the interaction rate with devotees is frequently moo [22]. The rise of advanced showcasing has given brand marketers with more channels to associated with shoppers, and components such as seen convenience, service quality, site openness, and shared substance have been found to affect advanced promoting and brand-consumer connections [23]. The improvement of data innovation has driven to changes in customer decision-making forms, counting the development of modern models such as the ROPO impact and turn around ROPO [24].

#### **The role of technology in shaping consumer behavior**

Innovation plays a noteworthy part in forming shopper behavior. The headways in advanced innovation have driven to changes in consumers' schedules and propensities, influencing the ways they communicate, devour, and advance [25]. The broad utilization of the web and advanced gadgets has expanded the significance of computerized promoting exercises, online client encounters, e-customer relationship administration, and client co-creation honos [26]. Moreover, innovation has an affect on the way people frame their sense of self and upgrade their convictions. It impacts inclinations for computerized items, shapes conviction upgrading through look motors, and influences inclination for fabric items [27]. Innovation grows the extend of alternatives for people to hold onto characters and accomplish positive self-verification, but it too presents challenges for shoppers [28]. Generally, innovation has both encouraged and prevented identity-based utilization, and assist investigate is required to investigate its affect on shopper behavior [29].

#### **Trends in Consumer Behavior in E-commerce**

##### **Shift towards online shopping**

Customer behavior in e-commerce has been moving towards online shopping. The rise of online promoting and the comfort it offers have made it a driving medium of showcasing [30]. Components such as site plan, comfort, and time reserve funds have been found to be persuasive in persuading customers to shop online [31]. Online stores are accessible 24/7, permitting clients to shop from anyplace, which includes to the offer of online shopping [32]. The web has revolutionized the way individuals shop and buy products, driving to a worldwide wonder of online shopping [33]. Companies have been utilizing the web to decrease promoting costs and offer competitive costs, whereas clients utilize it to compare costs and item highlights [34]. In general, the drift towards online shopping is driven by variables such as comfort, accessibility, and cost-effectiveness, making it a favored choice for buyers.

##### **Mobile commerce and the rise of m-commerce**

Portable commerce, moreover known as m-commerce, alludes to the utilize of remote convenient gadgets such as portable phones and tablets for online commercial exchanges. It permits clients to lock in in exercises such as obtaining and offering things, managing an account, and charge installment without the require for a tablet or PC [35]. M-commerce has gotten to be a unused insurgency in electronic commerce, advertising clients the opportunity to execute anytime and anyplace utilizing portable gadgets and remote systems [36]. It gives comfort, personalization, and localization, and has different employments in travel and tourism [37]. M-commerce has moreover driven to unused commerce breakthroughs, such as conveyance administrations, which upgrade the client encounter and increment standard buys [38]. Be that as it may, the selection of m-commerce moreover presents





Varanasi Rahul et al.,

challenges and security contemplations that got to be tended to [39]. The portable channel contains a noteworthy affect on driving deals concentration, with the versatile channel expanding the share of prevalent items compared to PC-based e-commerce channels . Supervisors got to re-examine their techniques to coordinated m-commerce with e-commerce successfully .

#### **Personalization and customization in e-commerce**

Personalization and customization are two concepts in e-commerce that point to adjust items or administrations to the inclinations of clients. Item personalization is started by the company based on client information, centering on personalized encounters and giving the company control over the method [40]. On the other hand, item customization is started by the client, based on their inclinations, and gives the customer control over the method, centering on adaptability and alternatives [41]. In cross-border e-commerce, brilliantly customization can offer assistance address the challenge of assembly different universal advertise requests. By utilizing shrewdly innovation and profound learning, cross-border e-commerce undertakings can recognize changes in showcase request, select items, and optimize item improvement [42]. Personalization methods, such as client division, can be connected in e-commerce to way better target and lock in clients. By examining statistic and psychographic division, businesses can alter their offers to meet client prerequisites and increment fulfillment and devotion [43]. Web personalization in e-commerce upgrades online users' recognitions and impacts their buy choices by giving comfort and expanding exchange utility [44].

#### **Social media influence on consumer behavior**

Social media stages have a noteworthy impact on shopper behavior and buy choices. They give buyers with get to to a riches of data, item audits, and user-generated substance, empowering them to form educated buy choices [45]. Client sharing on social media stages emphatically impacts consumers' discernments of chance, understanding of the item, and eagerness to buy [46]. Social media stages like Facebook, Twitter, Instagram, and YouTube have gotten to be fundamentally to consumers' every day lives and enormously impact their intuitive with brands and obtaining choices [47]. Social media too plays a significant part in forming client behavior and inclinations, with the control to boost perceivability, lock in with clients, and form shopper behavior [48]. Humanized client benefit on social media leads to positive client demeanors, less complaints, and higher client fulfillment [49]. In general, social media publicizing and promoting procedures are essential for companies to succeed within the advanced time and viably impact shopper behavior .

#### **Impact of user-generated content and online reviews**

User-generated content and online reviews have a significant impact on various industries, including travel, dining, retail, and healthcare. Consumers increasingly rely on social media platforms and review websites to gather information, read reviews, and evaluate experiences before making decisions. These platforms provide a space for users to share their thoughts and opinions, which can influence the perceptions and decisions of potential consumers [50] [51] [52] [53]. User-generated content and online reviews play a crucial role in shaping the online image and reputation of destinations, restaurants, retailers, and healthcare services [54] . They can impact consumer trust, purchase intentions, and satisfaction levels . Factors such as review valence, volume, and visual content can influence consumer trust and purchase decisions . Additionally, the topics and sentiments expressed in user reviews can affect the usefulness and popularity of the reviews . Overall, user-generated content and online reviews have become essential sources of information for consumers and have a significant influence on their decision-making processes.

#### **Strategies in E-commerce to Influence Consumer Behavior**

##### **User experience (UX) design and website usability**

Client involvement (UX) plan and site convenience are imperative components in buyer behavior. Companies recognize the esteem of giving a great client encounter and work deliberately to convey it successfully [55]. Convenience assessment and models have been created to evaluate the ease of use of items, which is closely related with client encounter [56]. Responsive plan and UX are essential variables in accomplishing victory on the web, and they have ended up broadly embraced around the world [57]. UX envelops the interaction between the client,





Varanasi Rahul et al.,

framework, and setting, and it can be categorized into ergonomic, cognitive, and passionate encounters [58]. In any case, there's no shared definition of UX, driving to distinctive translations and complicating the improvement of the field [59]. Within the plan field, there's a require for comprehensive ponders that consider all components and typologies of UX.

#### **Personalized marketing and targeted advertising**

Personalized showcasing and focused on publicizing have gotten to be vital methodologies for companies to meet client needs and desires [60]. Personalized promoting points to convey individualized messages to clients, pulling in more buyer consideration and possibly expanding deals [61]. In any case, focused on promoting raises concerns around data security, protection, and buyer control [62]. Shopper discernment of focused on promoting is impacted by variables such as buyer intrigued, substance validity, security concerns, mindfulness, and esteem conveyance [63]. The viability of focused on promoting is affected by shopper mindfulness, protection concerns, and esteem conveyance [64]. Focused on promoting permits marketers to recognize and reach particular target groups of onlookers, advertising items or administrations specifically to partners. Generally, personalized promoting and focused on promoting have the potential to make esteem for customers, but it is vital for marketers to address security concerns, pick up customer believe, and move forward straightforwardness and productivity

#### **Social media marketing and influencer collaborations**

In later a long time, social media promoting has seen a rise in influencer collaborations. Brands are progressively utilizing influencer promoting campaigns to advance their items and reach specialty gatherings of people [65]. Influencer showcasing includes compensating influencers to post almost a item or benefit on their social media profiles, leveraging their given adherent bases [66]. Marketers are presently contracting influencers to spread their things on social media stages, with the objective of convincing devotees to receive the suggested things and produce broad thing engendering [67]. Inquire about in this range has centered on parasocial intuitive, sponsorship, realness, and engagement and impact, as well as variables impacting shopper responses to social media influencer showcasing [68]. Social media stages have advanced from being simply social to getting to be a modern elective for promoting exercises, with influencer showcasing being one of the most recent methods [69].

#### **Customer relationship management (CRM) and loyalty programs**

Client relationship administration (CRM) may be a prepare that makes a difference companies construct and make strides connections with clients, with the point of expanding client devotion. CRM systems incorporate operational CRM, explanatory CRM, and collaborative CRM, which companies can utilize to preserve and create client connections. CRM has benefits such as empowering client devotion, decreasing costs, expanding operational productivity, expanding time to advertise, and expanding income [70]. Companies utilize CRM frameworks and innovations like fake insights (AI) and the web of things (IoT) to oversee connections with clients, screen their buys and dependability, and react to their request. CRM makes a difference businesses develop client dependability and maintenance, which can move forward deals and benefits. Dependability programs, such as advertising motivating forces and prizes for repetitive buys, are utilized to preserve client devotion and unwavering quality [71].

#### **Challenges and Ethical Considerations in Consumer Behavior Research**

##### **Privacy concerns and data protection**

Security concerns and information security are imperative contemplations in buyer behavior investigate. The utilize of third-party wearable innovations in inquire about raises concerns around member information protection and security [72]. The expanding utilize of independent vehicles (AVs) and the collection and transmission of information by on-board sensors moreover raises modern protection challenges [73]. The COVID-19 widespread has driven to the balance of investigate arrangements, which may raise moral issues related to information assurance [74]. Furthermore, the think about of buyer behavior and the advancement of proposal frameworks require the examination of shopper information, highlighting the require for security shields [75]. Within the field of neuro marketing, the utilize of neuro imaging strategies raises moral concerns with respect to protection and free will [76]. Generally, security and information assurance are vital contemplations in customer behavior inquire about, and



**Varanasi Rahul et al.,**

moral methods and lawful conventions ought to be taken after to guarantee the rights and well-being of members and buyers.

**Online scams and fraudulent practices**

Online customer extortion may be a critical issue with results such as false sales, exchanges, and the transmission of continues of wrongdoing. The utilize of modern innovations has given openings for criminal behavior, counting tricks, extortion, and duplicity. The predominance and significance of e-commerce have drawn consideration to the research of online shopper behavior, but there's a need of a well-developed show in this range. The Australasian Customer Extortion Errand Drive has conducted different exercises to avoid and raise mindfulness around buyer extortion, counting conducting online overviews to get it the flow of extortion victimization. The overviews have appeared that a tall extent of respondents have gotten trick solicitations, with false lotteries and computer bolster tricks being predominant. Scammers utilize different conveyance strategies such as mail, phone calls, SMS, and online stages to target potential casualties. Improved mindfulness is required for the dangers included in online shopping tricks and high-value shopper exercises. [77] [78] [79]

**Ethical implications of targeted advertising and behavioral tracking**

Focused on publicizing and behavioral following have moral suggestions due to concerns around security, straightforwardness, and customer control. Online behavioral focusing on (OBT) permits sponsors to track and create behavioral profiles of buyers, but it can damage protection rights and needs straightforwardness and opt-out alternatives [80]. Behavioral promoting, a subset of online personalization administrations, requires distinguishing proof, following, and prescient analytics, which can lead to negative results such as segregation and disintegration of individual independence [81]. Behavioral focusing on makes computerized dossiers on customers without express assent, undermining buyer independence and believe in e-commerce locales [82]. Clients are frequently uninformed of online following and express concerns around misfortune of security control and potential impediments in genuine life [83]. The financial suggestions of behavioral publicizing moreover raise questions almost industry structure and the benefits for diverse performing artists within the online publicizing esteem chain [84]. Generally, focused on promoting and behavioral following raise moral concerns related to protection, straightforwardness, shopper control, and industry structure.

**Implications and Future Directions****Insights for businesses and e-commerce platforms**

E-commerce applications offer comprehensive arrangements for businesses to oversee online deals, operations, and client connections. They give apparatuses for stock administration, shipping, charges, and analytics, making a difference businesses spare time and assets whereas extending their client base. Components impacting online deals over diverse e-commerce stages incorporate item rating, advertise share, clickstream, and estimating. Securing e-business from cyber dangers is pivotal for keeping up execution and notoriety. Also, leveraging cloud stages for information analytics can offer assistance businesses get it their clients and anticipate showcase patterns. E-commerce applications offer comprehensive arrangements for businesses to oversee online deals, operations, and client connections [85]. They give devices for stock administration, shipping, charges, and analytics, making a difference businesses spare time and assets whereas extending their client base [86]. Variables affecting online deals over diverse e-commerce stages incorporate item rating, showcase share, clickstream, and estimating [87] [88]. Securing e-business from cyber dangers is pivotal for keeping up execution and notoriety [89]. Also, leveraging cloud stages for information analytics can offer assistance businesses get it their clients and anticipate showcase patterns .

**Opportunities for further research in consumer behavior and e-commerce**

Customer behavior and e-commerce inquire about openings incorporate exploring the impact of electronic word of mouth (e-Wom), shopper rating, and notoriety on item buy deliberate [90]. Moreover, there's potential for in-depth investigation of distinctive e-commerce users' behavior, comprehensive judgment of variables influencing customer behavior, and evaluation of the affect of huge information on e-commerce buyer behavior [91]. Moreover, there's a



**Varanasi Rahul et al.,**

have to be investigate the impacts of time went through perusing item data on shopper behavior, utilizing machine learning strategies to get it client route on e-commerce websites, and analyzing non-linear connections in datasets [92]. In addition, there are openings to use portable utilization information for understanding buyer behaviours, predicting rehash buyers, and progressing benefit quality and proposal personalization in e-commerce [93]. Finally, there's a ought to encourage analyze the relationship between buyer behavior and supportability in e-commerce, considering themes such as city coordinations, enormous information investigation, client engagement, and circular economy [94].

### **Predictions for future trends in consumer behavior**

Shopper behavior is advancing due to mechanical headways and shifts in values and objectives. The field of customer behavior investigate is anticipated to proceed changing, and researchers foresee future patterns within the another twenty a long time. Globalization has driven to both standardized and culture-bound items, and there's a move towards post realist values. Furthermore, rising buyer patterns demonstrate a developing minority of consumers resenting current control and marketing hones, which can change consumerism within the coming decades. Shopper behavior is advancing due to innovative progressions and shifts in values and goals [95]. The field of customer behavior inquire about is anticipated to proceed changing, and researchers anticipate future trends within the following twenty a long time [96]. Globalization has driven to both standardized and culture-bound items, and there's a shift towards post realist values [97]. Developing shopper patterns demonstrate a developing minority of buyers detesting current control and promoting hones, which can change consumerism within the coming decades [98].

## **CONCLUSION**

### **Summary of key findings and insights**

The computerized age has altogether affected buyer behavior, driving to changes in shopping designs, a move towards e-commerce stages, and the impact of social media on shopper inclinations and patterns [99]. Data innovations have brought approximately unused models of shopper behavior forms, such as the ROPO impact, and have changed the decision-making handle for shoppers [100]. The advanced age has moreover driven to an increment in customer helplessness, influencing a wide run of buyers and requiring measures to address this defenselessness [101]. The advanced scene has changed shoppers into carefully proficient people, with get to to tremendous data, the capacity to compare brands and offerings, and the desire of comfort and sensible costs ^[Echavarría Ramírez]. Shoppers have ended up more delicate to the social, financial, and natural results of their showcase choices, but an irregularity between concerns and real utilization behavior exists, affected by different cognitive, social, and natural components ^[Engelbrecht].

### **Importance of understanding and adapting to consumer behavior in the digital age**

Understanding and adjusting to buyer behavior within the advanced age is significant for businesses and policymakers. The advanced time has altogether affected shopper designs, driving to changes in shopping behavior, a move towards e-commerce stages, and the utilize of social media in forming customer inclinations ^[Jochem van sanctum Boogert] ^[Widyatmoko] ^[RICARDO ECHAVARRÍA RAMÍREZ]. Shoppers presently anticipate personalized encounters, simple get to to information, and the capacity to create educated choices within the advanced commercial center ^[RICARDO ECHAVARRÍA RAMÍREZ] ^[Jose Ramon Saura, Ana Reyes-Menendez, Nelson Matos, Marisol B. Correia, Pedro R. Palos-Sanchez]. The improvement of the Web and related innovations has moreover driven to new models of buyer behavior forms, such as the ROPO impact, which companies got to consider when reinforcing their deals procedures [102]. By and large, understanding and adjusting to shopper behavior within the advanced age is fundamental for businesses to viably lock in with clients and impact their behavior, eventually driving to expanded deals and commerce improvement ^[Jose Ramon Saura, Ana Reyes-Menendez, Nelson Matos, Marisol B. Correia, Pedro R. Palos-Sanchez].







## REFERENCES

1. Jochem, van, den, Boogert. (2023). Impact of social and economic changes on urban community consumption patterns in the digital era. Doi: 10.31219/osf.io/pb26y(2023).
2. Consumer vulnerability in the digital age. OECD digital economy papers, Doi: 10.1787/4d013cc5-en (2022).
3. The general circumstances of digital consumer behaviour in Europe. Doi: 10.4324/9781003263685-1
4. RICARDO, ECHAVARRÍA, RAMÍREZ. (2023). Changing Structure of Consumer Buying Behaviour and Expectation in the Digital Era. Doi: 10.1007/978-981-19-7880-7\_12(2022).
5. Changes in consumer behaviour in the digital age. Doi: 10.4324/9781003263685-3
6. Sabina-Cristiana, Necula. (2023). Exploring the Impact of Time Spent Reading Product Information on E-Commerce Websites: A Machine Learning Approach to Analyze Consumer Behavior. Behavioral sciences, doi: 10.3390/bs13060439
7. Rohani, Rohani, Andi, Hadidu., Manda, Hm. (2023). Consumer Behavior: Components of Purchase Intention Products E-Commerce Perspective Maqāsid Al-Sharī'ah. JESI (Jurnal Ekonomi Syariah Indonesia), doi: 10.21927/jesi.2023.13(2).198-209
8. Hua, Lv. (2022). E-commerce consumer behavior analysis based on big data. Journal of Computational Methods in Sciences and Engineering, doi: 10.3233/jcm-226628
9. Abhishek, Tibrewal. (2022). A Study Showing the Impact of E-Marketing on Consumer Purchase Behaviour. Indian Scientific Journal Of Research In Engineering And Management, doi: 10.55041/ijsrem16755
10. Hossein, Bodaghi, Khajeh, Noubar., Sam, Rahimzadeh, Holagh., Arezoo, Sadri. (2023). Identifying Factors Affecting Green Consumer Purchase Behavior on E-Commerce Websites. TalTech journal of European studies, doi: 10.2478/bjes-2023-0003
11. (2023). Digital Innovation and Sustainability Driven Consumer Behavior: A Review and Research Agenda. Doi: 10.20944/preprints202306.1604.v1
12. Andrea, Appolloni., Vincenzo, Basile., Federica, Caboni., Lucia, Pizzichini. (2023). An innovative approach to online consumer behaviour segmentation: the self-determination theory in an uncertain scenario. European Journal of Innovation Management, doi: 10.1108/ejim-11-2022-0609
13. Hua, Lv. (2022). E-commerce consumer behavior analysis based on big data. Journal of Computational Methods in Sciences and Engineering, doi: 10.3233/jcm-226628
14. Muluken, Assefa, Ayalew., Shimelis, Zewdie. (2022). What Factors Determine the Online Consumer Behavior in This Digitalized World? A Systematic Literature. Human behavior and emerging technologies, doi: 10.1155/2022/1298378
15. Waqas, Haider, Bangyal., Adnan, Ashraf., Rabia, Shakir., Najeeb, Ur, Rehaman. (2022). A Review on Consumer Behavior Towards Online Shopping using Machine Learning. Doi: 10.54938/ijemdcsai.2022.01.1.84 (2023).
16. Basics of consumer behavior. Doi: 10.4337/9781803923192.00006 (2023).
17. Consumer behavior. Doi: 10.11647/obp.0362.05 (2023).
18. Consumer behavior. Doi: 10.11647/obp.0361.05
19. Tainá, Veras, de, Sandes-Freitas. (2023). Introduction to Consumer Behavior. Doi: 10.4324/9780367426897-2
20. Jochem, van, den, Boogert. (2023). Impact of social and economic changes on urban community consumption patterns in the digital era. Doi: 10.31219/osf.io/pb26y
21. Nils, Engelbrecht. (2022). Responsible Consumer Behavior in the Digital Age. Doi: 10.53846/goediss-9428
22. Valérie, Dietrich. (2022). Consumption in the Digital Age. Doi: 10.4018/978-1-6684-6287-4.ch099
23. H., Mickle, Aancy., Shallini, S., Taneja., P., Venkateswara, Rao., Binkey, Srivastava. (2023). Identifying the factors influencing digital marketing and brand-consumer relationship. Risk and Decision Analysis, doi: 10.3233/rda-231505 (2022).
24. Changes in consumer behaviour in the digital age. Doi: 10.4324/9781003263685-3
25. (2023). Role of Digital Marketing in Enhancing Brand Engagement and Consumer Behavior. International Journal of Advanced Research in Science, Communication and Technology, doi: 10.48175/ijarsct-12100
26. (2022). Conclusion. Doi: 10.4324/9781003307105-9





27. İlayda, İpek. (2020). Understanding Consumer Behavior in Technology-Mediated Spaces. Doi: 10.1007/978-3-030-08277-2\_11
28. Eugina, Leung. (2019). How Technology Shapes Consumption: Implications for Identity and Judgement.
29. Eugina, Leung., Gabriele, Paolacci., Stefano, Puntoni. (2019). How technology shapes identity-based consumer behavior. Doi: 10.4337/9781788117739.00027
30. V., Pal, P., Vakula, Kumari. (2023). Consumer Buying Behaviour towards Online Shopping. Journal of business management and information systems, doi: 10.48001/jbmis.2023.1001002
31. (2023). Consumer Perception towards Online Shopping. International Journal For Multidisciplinary Research, doi: 10.36948/ijfmr.2023.v05i02.2160
32. 32)Gowripeddi, Hari, kumar., D., P. (2022). Consumer behaviour towards online shopping. Journal of management and science, doi: 10.26524/jms.12.27
33. Glynn, T., Tonsor. (2022). Consumer behaviortowardse- commerce: online shopping. Indian Scientific Journal Of Research In Engineering And Management, doi: 10.55041/ijrsrem12519
34. Muskan, Grover. (2022). Consumer behaviour towards online shopping. Indian Scientific Journal Of Research In Engineering And Management, doi: 10.55041/ijrsrem11732
35. (2023). M-Commerce and its impact on Today's Economy. Doi: 10.36548/rrrj.2023.1.15
36. Suhaib, Aamir. (2022). Mobile Commerce (mCommerce). Doi: 10.4337/9781800377486.mobile.commerce
37. Andi, Leo., Verri, Kuswanto., Lily, Damayanti. (2022). Mobile Commerce untuk Sales Order dan Tracking Order berbasis MVC. Algor, doi: 10.31253/algor.v4i1.1748
38. (2022). A Three-Level Gateway protocol for secure M-Commerce Transactions using Encrypted OTP. Doi: 10.1109/icaaic53929.2022.9792908
39. (2022). M-Commerce, Sales Concentration, and Inventory Management. M&som-manufacturing& Service Operations Management, doi: 10.1287/msom.2021.1071
40. (2023). A comparison of product personalization and product customization: a conceptual framework. Turkish Business Journal, doi: 10.51727/tbj.1306824
41. Chun, Qing, Guo., Xiaodong, Zhang. (2022). Research on Intelligent Customization of Cross-Border E-Commerce Based on Deep Learning. Mathematical Problems in Engineering, doi: 10.1155/2022/4211616
42. D., Rakesh., Babu, Dinesh., Chaitanya, Bharathi. (2023). Demographic and Psychographic Customer Segmentation for Ecommerce Applications. Doi: 10.1109/ICAaic56838.2023.10140861
43. 43)Su, Chen. (2021). Analysis of Customization Strategy for E-Commerce Operation Based on Big Data. Wireless Communications and Mobile Computing, doi: 10.1155/2021/6626480
44. Mahesh, Balan, Umaithanu., Saji, K., Mathew. (2022). The Persuasive Nature of Web Personalization on Online Users' Product Perception: A Mental Accounting Perspective. AIS transactions on human-computer interaction, doi: 10.17705/1thci.00162
45. N., N.. (2023). Role of Social Media in Influencing Consumer Purchase Behaviour and Brand Loyalty in Bengaluru City. Indian Scientific Journal Of Research In Engineering And Management, doi: 10.55041/ijrsrem22598
46. Yang, Liu. (2023). The Influence of User Sharing Behavior on Consumer Purchasing Behavior in social media. Journal of Education, Humanities and Social Sciences, doi: 10.54097/ehss.v13i.7893
47. (2023). Impact of Social Media on Consumer Behaviour and Preference. International Journal For Multidisciplinary Research, doi: 10.36948/ijfmr.2023.v05i02.2171
48. Pedro, Miguel, Casavilca. (2023). Consumer Behavior and Customer Service on Social Media Platforms. Doi: 10.31390/gradschool\_dissertations.6061
49. (2023). Influence on Social Media Advertising on Consumer Behavior. International Journal For Multidisciplinary Research, doi: 10.36948/ijfmr.2023.v05i02.2099
50. Emil, L., Jacobsen. (2022). Impact of social media-based user-generated content on online reputation of tourist destinations. Doi: 10.4337/9781800371415.00013
51. Shizhen, Bai., Xuezhen, Zheng., Chunjia, Han., Xin, Bi. (2023). Exploring user-generated content related to vegetarian customers in restaurants: An analysis of online reviews. Frontiers in Psychology, doi: 10.3389/fpsyg.2022.1043844





**Varanasi Rahul et al.,**

52. Meizhu, Pan. (2023). Discussion of Online Reviews' Impacts on Consumers' Behaviors. *Journal of Education, Humanities and Social Sciences*, doi: 10.54097/ehss.v13i.7897
53. Jingfang, Liu., Lu, Gao. (2021). Research on the Characteristics and Usefulness of User Reviews of Online Mental Health Consultation Services: A Content Analysis..*Healthcare*, doi: 10.3390/HEALTHCARE9091111
54. Thao, Thanh, Thi, Nguyen., Shurong, Tong. (2022). The impact of user-generated content on intention to select a travel destination. *Journal of marketing analytics*, doi: 10.1057/s41270-022-00174-7
55. (2022). UX Concepts and Perspectives – From Usability to User-Experience Design. doi: 10.1201/9780429343513-2
56. (2022). Usability and User Experience. doi: 10.1201/9780429343490-2
57. (2022). Importance of design and user experience (UX) in web development. doi: 10.56294/mr202220
58. (2023). User Experience and UX Research. doi: 10.1007/978-1-4842-9268-6\_2
59. Aurora, Berni., Yuri, Borgianni. (2021). From the definition of user experience to a framework to classify its applications in design. doi: 10.1017/PDS.2021.424
60. Selay, Ilgaz, Sümer., Çağatay, Berke, Erdaş., Emre, Sümer., Ahmet, Paker. (2022). A New Tool for Personalized Advertising in Shopping Malls: A Smart Billboard System. *Archives of current research international*, doi: 10.9734/acri/2022/v22i8547
61. (2022). Targeted Advertising and Consumer Protection Law in the EU. doi: 10.31235/osf.io/jbpsm
62. Pranay, Goswami., Krishnan, Ramanathan., Abhinita, Daiya. (2022). Stalker Ads: A study to Understand the Consumer Awareness and Perception towards Targeted Advertising. doi: 10.1109/ICCUBEA54992.2022.10010774
63. (2022). Stalker Ads: A study to Understand the Consumer Awareness and Perception towards Targeted Advertising. doi: 10.1109/iccubea54992.2022.10010774
64. Oleksii, Yarmoliuk., Olena, Borysenko., Iuliia, Fisun. (2022). Teoretical and methodological aspects of targeting advertising as a tool for integrated internet marketing. doi: 10.32999/ksu2307-8030/2022-46-4
65. USTUN., Ahmet, Berk. (2023). Brand-SMI collaboration in influencer marketing campaigns: A transaction cost economics perspective. *Technological Forecasting and Social Change*, doi: 10.1016/j.techfore.2023.122580
66. Rastko, Milošević., Ana, Komlenić., Nemanja, Kašiković., Bojan, Banjanin., Davor, Menzildžić. (2022). Instagram influencers' responsiveness to a small business collaboration outreach. *Proceedings*, doi: 10.24867/grid-2022-p25
67. Xiao, Han., Leye, Wang., Weiguo, Fan. (2022). Cost-Effective Social Media Influencer Marketing. *Inform Journal on Computing*, doi: 10.1287/ijoc.2022.1246
68. Yatish, Joshi., Weng, M., Lim., Khyati, Jagani., Sanjay, Kumar. (2023). Social media influencer marketing: foundations, trends, and ways forward. *Electronic Commerce Research*, doi: 10.1007/s10660-023-09719-z
69. Anita, Cornelia, Szakal. (2022). Influencer Marketing. *Bulletin of the Transilvania University of Brasov. Series V : Economic Sciences*, doi: 10.31926/but.es.2022.15.64.2.6
70. Diana, Ari, Suryaningsih. (2022). Customer Relationship Management PT AgrapanaWukirPanca. *Journal Research of Social Science, Economics, and Management*, doi: 10.36418/jrssem.v1i11.197
71. (2022). CUSTOMER RELATIONSHIP MANAGEMENT (CRM) STRATEGY PT. TELKOM THE RIAU Mainland TELECOMMUNICATION REGION IN MAINTAINING INDIHOME CUSTOMER LOYALTY. doi: 10.25299/medium.2021.vol9(2).10219
72. Anna, Sui. (2023). Ethical considerations for the use of consumer wearables in health research. doi: 10.1177/20552076231153740
73. Ioannis, Krontiris., Kalliroi, Grammenou., Kalliopi, Terzidou., Marina, Zacharopoulou., Marina, Tsikintikou., Foteini, Baladima., Chrysi, Sakellari., Konstantinos, Kaouras. (2020). Autonomous Vehicles: Data Protection and Ethical Considerations. doi: 10.1145/3385958.3430481
74. Nicola, Straiton., Anne, McKenzie., J, Bowden., Alistair, Nichol., R, Murphy., Tom, Snelling., John, Zalberg., J, Clements., J, Stubbs., A, Economides., D., H., Kent., J, Ansell., Tanya, Symons. (2020). Facing the Ethical Challenges: Consumer Involvement in COVID-19 Pandemic Research.. *Journal of Bioethical Inquiry*, doi: 10.1007/S11673-020-10060-5





## Varanasi Rahul et al.,

75. Ghanasiyaa, Sundareswaran., Harshini, Kamaraj., S., Sanjay., Akalya, Devi., Poojashree, Elangovan., Kruthikkha, P. (2022). Consumer Behavior Analysis. International Journal of Research and Applied Technology, doi: 10.34010/injuratech.v2i1.6536
76. Eugenia, Laureckis., Àlex, Martínez, Miralpeix. (2017). Ethical and Legal Considerations in Research Subject and Data Protection. doi: 10.1007/978-3-319-45609-6\_5
77. Andrew, Harrison., William, N., Dilla, Brian, E., Mennecke. (2020). Relationships within the Fraud Diamond: The Decision Processes That Influence Fraudulent Intentions in Online Consumer Fraud. Journal of Information Systems, doi: 10.2308/ISYS-52627
78. (2022). Trends in online consumer fraud:. doi: 10.4324/9781003017189-9
79. Michelle, Berzins. (2009). Online Scams: case studies from Australia. doi: 10.4018/978-1-60566-368-5.CH049
80. Alexander, Nill., Robert, J., Aalberts. (2014). Legal and Ethical Challenges of Online Behavioral Targeting in Advertising. Journal of current issues and research in advertising, doi: 10.1080/10641734.2014.899529
81. Robert, Bodle. (2016). A Critical Theory of Advertising as Surveillance: Algorithms, Big Data, and Power. doi: 10.4324/9781315625768-18
82. Catherine, Dwyer. (2009). Behavioral Targeting: A Case Study of Consumer Tracking on Levis.com. Social Science Research Network, doi: 10.2139/SSRN.1508496
83. Wiebke, Thode., Joachim, Griesbaum., Thomas, Mandl. (2015). "I would have never allowed it": User Perception of Third-party Tracking and Implications for Display Advertising. Ingénierie Des SystèmesD'information, doi: 10.5281/ZENODO.17971
84. Anthony, Nicoll, Smith-Grieco. (2010). The Internet as recommendation engine : implications of online behavioral targeting.
85. (2023). Exploring the Benefits of E-commerce Applications for Efficient Online Operations. International journal of scientific research in computer science, engineering and information technology, doi: 10.32628/cseit2390212
86. Hongyan, Dai., Qin, Xiao., Nina, Yan., Xun, Xu., Tin, Sun, Tong. (2022). What Influences Online Sales Across Different Types of E-Commerce Platforms. International Journal of Electronic Commerce, doi: 10.1080/10864415.2022.2076196
87. Aymen, Belghith. (2022). Investigation on e-Commerce Platforms for Tackling e-Business Security Challenge. International journal on engineering applications, doi: 10.15866/irea.v10i6.20649
88. Jin, Zhong, Yu., Jingjing, Zhao., Chi, Zhou., Yufei, Ren. (2022). Strategic Business Mode Choices for E-Commerce Platforms under Brand Competition. Journal of Theoretical and Applied Electronic Commerce Research, doi: 10.3390/jtaer17040089
89. John, Yeung. (2021). Data Analytics Architectures for E-Commerce Platforms in Cloud. doi: 10.47738/IJAIM.V11I1.3
90. Rohani, Rohani., Andi, Hadidu., Manda, Hm. (2023). Consumer Behavior: Components of Purchase Intention Products E-Commerce Perspective Maqāsid Al-Sharī'ah. JESI (Jurnal Ekonomi Syariah Indonesia), doi: 10.21927/jesi.2023.13(2).198-209
91. Hua, Lv. (2022). E-commerce consumer behavior analysis based on big data. Journal of Computational Methods in Sciences and Engineering, doi: 10.3233/jcm-226628
92. Sabina-Cristiana, Necula. (2023). Exploring the Impact of Time Spent Reading Product Information on E-Commerce Websites: A Machine Learning Approach to Analyze Consumer Behavior. Behavioral sciences, doi: 10.3390/bs13060439
93. Tais, Pagoto, Bélo. (2022). Consumer Behavior Analysis and Repeat Buyer Prediction for E-commerce. doi: 10.53846/goediss-7770
94. Paulo, Rita., Ricardo, Filipe, Ramos. (2022). Global Research Trends in Consumer Behavior and Sustainability in E-Commerce: A Bibliometric Analysis of the Knowledge Structure. Sustainability, doi: 10.3390/su14159455.
95. Dr., Asha, Rathi. (2023). New trends in india's consumer buying behaviour. EPRA international journal of economic and business review, doi: 10.36713/epra12575
96. Maayan, S., Malter., Morris, B., Holbrook., Barbara, E., Kahn., Jeffrey, R., Parker., Donald, R., Lehmann. (2020). The past, present, and future of consumer research. Marketing Letters, doi: 10.1007/S11002-020-09526-8





**Varanasi Rahul et al.,**

97. (2023). Global trends in consumer behavior. doi: 10.4337/9781803923192.00009
98. Huining, Liu. (2023). Consumer Behavior Prediction in the Big Data Era: a Comparison Analysis. BCP business & management, doi: 10.54691/bcpbm.v38i.3826
99. Jochem, van, den, Boogert. (2023). Impact of social and economic changes on urban community consumption patterns in the digital era. Doi: 10.31219/osf.io/pb26y
100. (2022). Changes in consumer behaviour in the digital age. Doi: 10.4324/9781003263685-3
101. (2023). Consumer vulnerability in the digital age. OECD digital economy papers, doi: 10.1787/4d013cc5-en
102. Jochem, van, den, Boogert. (2023). Impact of social and economic changes on urban community consumption patterns in the digital era. doi: 10.31219/osf.io/pb26y





## Effectiveness of Incentive Spirometer Along with 4-7-8 Breathing Technique on Lung Function and Anxiety in Obese and Overweight Individuals: A Pilot Study

Jishna Muchhala<sup>1</sup>, Asha Dobariya<sup>2\*</sup> and Gaurav j Patel<sup>3</sup>

<sup>1</sup>MPT Scholar, Department of Physiotherapy, Ahmedabad Physiotherapy College, Parul University, Gujarat, India.

<sup>2</sup>Assistant Professor, Department of Physiotherapy, Ahmedabad Physiotherapy College, Parul University, Gujarat, India.

<sup>3</sup>Principal, Department of Physiotherapy, Ahmedabad Physiotherapy College, Parul University, Gujarat, India.

Received: 22 Jan 2024

Revised: 09 Feb 2024

Accepted: 27 Apr 2024

### \*Address for Correspondence

**Asha Dobariya**

Assistant Professor,

Department of Physiotherapy,

Ahmedabad Physiotherapy College,

Parul University, Gujarat, India.

Email: jishnamuchhala.jm@gmail.com



This is an Open Access Journal / article distributed under the terms of the **Creative Commons Attribution License** (CC BY-NC-ND 3.0) which permits unrestricted use, distribution, and reproduction in any medium, provided the original work is properly cited. All rights reserved.

### ABSTRACT

Overweight and obesity may serve as parameters which may not allow an individual to attain the definition of health as per WHO. Children as well as adults are being embattled by various junk food and lack of activity proceeding to various health issues amongst every age group. An incentive spirometer is a device that measures the volume of the air inhaled into the lungs during inspiration. In today's fast-paced world, stress and anxiety have become increasingly common. Finding effective relaxation techniques to calm the mind and body is essential for our well-being. One such technique gaining popularity is the 4-7-8 breathing method. 10 individuals both male & female between 18-25 years of age having BMI  $\geq 25\text{kg/m}^2$  were included in the study through convenient sampling. Lung function was measured using pulmonary function test. The HAM-A scale was used for measuring anxiety severity. An experimental group received incentive spirometer along with 4-7-8 breathing technique for 4days/week for 3 weeks. Data were collected at the baseline and after 3 weeks of intervention, analysed with SPSS 29.0. Result showed improvement in both the outcomes.

**Keywords:** Overweight & obesity, Incentive spirometer, 4-7-8 breathing technique, lung function, anxiety





## INTRODUCTION

Excessive weight and obesity can act as factors preventing individuals from meeting the World Health Organization's definition of health. Presently, health is a significant issue in both developed and developing countries, where rapid industrialization and globalization are on the rise[1]. Obesity, a persistent health condition, is widespread in both developed and developing nations, impacting individuals across various age groups, from children to adults. Its prevalence has reached a point where it is supplanting conventional public health worries like under nutrition and infectious diseases, emerging as a primary contributor to poor health[2]. Significant changes occur in the mechanical characteristics of the lungs and chest wall in obesity, mainly attributed to the accumulation of fat in the mediastinum and abdominal cavities. These modifications lead to decreased compliance in the lungs, chest wall, and the entire respiratory system, likely playing a role in the respiratory symptoms associated with obesity, such as wheezing, breathlessness, and difficulty breathing while lying down. The use of Incentive Spirometer Exercise (ISE) is prevalent in chest physiotherapy. This technique motivates patients to engage in deliberate and profound inhalation, facilitated by visual feedback. This approach enables the expansion and opening of collapsed airways, promoting better lung function[4]. There are multiple factors suggesting a potential link between obesity and deteriorated mental health, particularly in terms of heightened anxiety and depression. Additionally, another rationale for anticipating this association is that obesity is correlated with various physical health issues, which, in turn, serve as risk factors for the development of depression. The interconnected nature of these aspects underscores the potential impact of obesity on mental well-being which leads to anxiety[5]. Discovering efficient techniques to relax the mind and body is crucial for overall well-being. A method that is gaining widespread recognition in this regard is the 4-7-8 breathing technique. This approach involves a specific breathing pattern designed to promote relaxation and cultivate a sense of calmness. Embracing practices like the 4-7-8 breathing method can significantly contribute to enhancing our mental and physical state, fostering a more balanced and tranquil lifestyle[6]. Several studies indicate that excess weight and obesity impact the chest wall and mechanical characteristics of the lungs, while anxiety has repercussions on cardiopulmonary functions. Incentive spirometry aids in enhancing lung volume, and the 4-7-8 breathing technique contributes to stress and anxiety reduction. However, there is a lack of research examining the combined impact of incentive spirometry and the 4-7-8 breathing technique in individuals who are overweight or obese. Therefore, this study is formulated to assess the effectiveness of combining incentive spirometry with the 4-7-8 breathing technique in improving lung function and reducing anxiety levels in overweight and obese individuals.

## MATERIALS AND METHODS

The study design involved a sample size of 10 participants who underwent for the treatment duration spanned 12 sessions conducted over 3 weeks. In this pilot study, several materials were used, including an assessment form, consent form, PFT instrument, Incentive spirometer and Anxiety scale. Participants of both the genders aged between 18-25 years and BMI  $\geq 25\text{kg/m}^2$  were taken in the study. Subjects with any kind of recent infection and currently receiving any treatment or medication of any cardiopulmonary conditions were excluded.

### Outcome measures

Pulmonary function test (PFT) (FVC, FEV1, FEV1/FVC, PEFR) (ICC=0.75-0.9) was taken to check lung function[4] and HAM- A anxiety scale (ICC= 0.709) was taken for anxiety level[7].

### Intervention

Individuals allocated to the experimental group were directed to utilize the spirometer by engaging in deliberate, slow, and deep inhalation for a series of 10 repetitions, with the instruction to repeat this sequence at least five times daily[8]. The 4-7-8 breathing technique involves breathing in for 4 seconds, holding the breath for 7 seconds, and exhaling for 8 seconds and was repeated for four breaths[6]. The intervention was given for 12 sessions in the time period of 3 weeks. The data were taken at the baseline and after completion of 12 sessions.





## RESULTS

Data was analysed using the statistical package SPSS 29.0 and level of significance was set at  $p < 0.05$ . Normality of the data was assessed using Shapiro Wilkison test. To find the difference within group for calculating pre and post data Paired sample t test was used. All the tables for the results are given below.

## DISCUSSION

As overweight and obesity affects lungs and chest wall largely due to fat deposits in the mediastinum and the abdominal cavities. These alterations reduce the compliance of the lungs, chest wall and entire respiratory system. An incentive spirometer is a device that will expand your lungs by helping you breathe more deeply and fully and PFT measure lung volume and capacities. The increase in PFT parameters in this study can be because of the use of incentive spirometer. Breathing is an automatic function of the body that is controlled by the respiratory center of the brain. Due to anxiety, cortisol and adrenaline production changes which hampers breathing patterns. 4-7-8 breathing exercise focus on inspiration followed by a hold which activates parasympathetic nervous system which slows down the heart rate and causes the body to relax and slow down respiration. More the duration more the air can be expelled out. The slow breathing pattern increases, improves oxygenation that signals the brain to release GABA, which in turn inhibit the release of cortisol and adrenaline which reduces anxiety and depression. The decrease in anxiety level in this study can be because of 4-7-8 breathing technique.

## CONCLUSION

In conclusion, the findings of this study provide compelling evidence supporting the efficacy of both the incentive spirometer and the 4-7-8 breathing technique in enhancing pulmonary function and mitigating anxiety levels.

## ACKNOWLEDGEMENT

I extend my deepest gratitude to the Almighty for providing me with the strength, guidance, and resilience throughout this research journey. Without His blessings, this endeavour would not have been possible. I express my sincere appreciation to my research guide, Dr. Asha Dobariya, whose unwavering support, valuable insights, and mentorship have been instrumental in shaping this research. I am profoundly thankful to Dr. Gaurav J Patel, the Principal and Head of the Department, for fostering an environment of academic excellence and providing the resources necessary for the successful completion of this study. My heartfelt thanks also go to all the participants.

## REFERENCES

1. Mukhra R, Kaur T, Krishan K, Kanchan T. Overweight and Obesity: A major concern for health in India. *La Clinica Terapeutica*. 2018 Sep 10;169(5):e199-201.
2. World Health Organization. Obesity: preventing and managing the global epidemic: report of a WHO consultation.
3. Dixon AE, Peters U. The effect of obesity on lung function. *Expert review of respiratory medicine*. 2018 Sep 2;12(9):755-67.
4. Choi JY, Rha DW, Park ES. Change in pulmonary function after incentive spirometer exercise in children with spastic cerebral palsy: a randomized controlled study. *Yonsei Medical Journal*. 2016 May 1;57(3):769-75.







**Jishna Muchhala et al.,**

5. Jorm AF, Korten AE, Christensen H, Jacomb PA, Rodgers B, Parslow RA. Association of obesity with anxiety, depression and emotional well-being: a community survey. Australian and New Zealand journal of public health. 2003 Aug;27(4):434-40.
6. Does H. 4-7-8 Breathing: How It Works, Benefits, and Uses.
7. Maier W, Buller R, Philipp M, Heuser I. The Hamilton Anxiety Scale: reliability, validity and sensitivity to change in anxiety and depressive disorders. Journal of affective disorders. 1988 Jan 1;14(1):61-8.
8. Cattano D, Altamirano A, Vannucci A, Melnikov V, Cone C, Hagberg CA. Preoperative use of incentive spirometry does not affect postoperative lung function in bariatric surgery. Translational Research. 2010 Nov 1;156(5):265-72.

**Table-1: Mean and standard deviation of Weight, Height, BMI of the intervention group.**

	MEAN	STANDARD DEVIATION
<b>WEIGHT</b>	80.4000	6.83455
<b>HEIGHT</b>	160.5000	6.41613
<b>BMI</b>	31.2100	3.06755

**Table-2: PRE AND POST mean values and standard deviation of Forced vital capacity (FVC)**

FVC	Pre	Post
<b>Mean</b>	94.0000	97.6000
<b>Standard Deviation</b>	16.97711	18.77469
<b>p-Value</b>	<0.001	

After the intervention was given to all the subjects, in the post value it was concluded that it showed statistically significant result and p value of FVC was found <0.001.

**Table-3: PRE AND POST mean values and standard deviation of Forced expiratory volume (FEV1).**

FEV1	Pre	Post
<b>Mean</b>	103.8000	106.3000
<b>Standard Deviation</b>	20.57939	22.41056
<b>p-Value</b>	<0.001	

After the intervention was given to all the subjects, in the post value it was concluded that it showed statistically significant result and p value of FEV1 was found <0.001.

**Table-4: PRE AND POST mean values and standard deviation of FEV1/FVC.**

FEV1/FVC	Pre	Post
<b>Mean</b>	110.6000	118.4000
<b>Standard Deviation</b>	10.21111	7.21418
<b>p-Value</b>	<0.001	

After the intervention was given to all the subjects, in the post value it was concluded that it showed statistically significant result and p value of FEV1/FVC was found <0.001.

**Table-5: PRE AND POST mean values and standard deviation of Peak expiratory flow rate (PEFR).**

PEFR	Pre	Post
<b>Mean</b>	84.1000	91.5000
<b>Standard Deviation</b>	27.15572	29.01819
<b>p-Value</b>	<0.001	

After the intervention was given to all the subjects, in the post value it was concluded that it showed statistically significant result and p value of PEFR was found <0.001.





**Jishna Muchhala et al.,**

**Table-6: PRE AND POST mean values and standard deviation of Anxiety scale.**

ANXIETY SCALE	Pre	Post
Mean	17.8000	14.9000
Standard Deviation	3.04777	2.37814
p-Value	<0.001	

After the intervention was given to all the subjects, in the post value it was concluded that it showed statistically significant result and p value of anxiety scale was found <0.001.





## Evaluation and Comparison of the Efficacy of Teeth Whitening System Containing Phthalimido Peroxy Caproic Acid in Conjunction with and without 810nm Diode Laser: A Split-Mouth Study

Avneet Kaur<sup>1\*</sup>, Pramod Waghmare<sup>2</sup> and Vidya Dodwad<sup>3</sup>

<sup>1</sup>Postgraduate Student, Department of Periodontology, Bharati Vidyapeeth (Deemed to be University), Pune, Maharashtra, India.

<sup>2</sup>Professor and Guide, Department of Periodontology, Bharati Vidyapeeth (Deemed to be University), Pune, Maharashtra, India.

<sup>3</sup>Head of the Department, Department of Periodontology, Bharati Vidyapeeth (Deemed to be University), Pune, Maharashtra, India.

Received: 22 Jan 2024

Revised: 09 Feb 2024

Accepted: 27 Apr 2024

### \*Address for Correspondence

**Avneet Kaur**

Postgraduate Student,

Department of Periodontology,

Bharati Vidyapeeth (Deemed to be University),

Pune, Maharashtra, India.

Email: kauravneet1995.ak@gmail.com



This is an Open Access Journal / article distributed under the terms of the **Creative Commons Attribution License** (CC BY-NC-ND 3.0) which permits unrestricted use, distribution, and reproduction in any medium, provided the original work is properly cited. All rights reserved.

### ABSTRACT

Tooth color is an important issue for esthetic dentistry professionals and for patients who wish to enhance the appearance of their smiles. Bleaching procedure uses chemical substances with high potential for free oxygen radicals release, such as hydrogen peroxide (HP) or one of its precursors, notably carbamide peroxide (CP). Disadvantage of using these peroxide based chemicals is they cause mucosal burns and irreversible damage to enamel resulting in teeth sensitivity. Recent advances in bleaching has lead to the use of phthalimido peroxy caproic(PAP), an organic molecule with high potential of oxidation. Laser energy is also relatively novel approach for teeth whitening. Laser tooth whitening with this teeth whitening gel may or may not accelerate tooth whitening process. Hence, this study was done to objectively evaluate and compare the clinical efficacy of teeth whitening system containing PAP in conjunction with and without an 810 nm diode laser. Amongst the patients visiting the Outpatient Department of Periodontology, Bharati Vidyapeeth (Deemed to be University) Dental College and Hospital, Pune, 15 patients with extrinsic stains and tooth shade A2- A3.5 according to Vita classical shade guide were included in order to standardize the study. The sample size for this study was 30 sites. They were divided into 2 groups (group A treated with phthalimido peroxy caproic acid along with 810nm diode laser and group B treated with phthalimido peroxy caproic acid without laser). Phase I





Avneet Kaur et al.,

therapy was carried out and then treated according to group A and group B plan in a split mouth design in the same patient. Data was recorded and descriptive statistics were then expressed as numbers and percentages. A statistically significant p-value of less than or equal to 0.05 was considered. Group A showed shade change in all the 15 sites whereas Group B showed no change in shade in any site. Bleaching agent showed better results when used with laser compared to that when it was used alone. Laser bleaching can be deemed as a more efficient teeth whitening technique thus useful in improving esthetics.

**Keywords:** Laser, Phthalimidoperoxycaproic acid, Bleaching, Vita shade guide, Peroxides.

## INTRODUCTION

A beautiful smile is important in social interactions; also, mass media influences many individuals to seek an effective, long-lasting, and simple treatment plan.[1] Bleaching technique can be a conservative method to provide patients with a beautiful smile[2-4] when compared to other techniques such as laminate veneers, composite fillings or full-coverage restorations. The chromatic properties of enamel, dentin, and pulp determine tooth color.[4,5] Teeth discolorations, on the other hand, differ in genesis, appearance, location, severity, and tooth structure. Internal and external discolorations are two types of discolorations. External tooth discolorations can be removed by prophylactic procedures, but treating internal discolorations requires chemical bleaching techniques.[4]The bleaching techniques primarily use bleaching agents such as hydrogen peroxide (HP), carbamide peroxide(CP) or Phthalimidoperoxycaproic acid(PAP) of different concentrations.[6] Vital bleaching of teeth involves the external application, whereas non-vital bleaching involves either internal (within the pulp chamber) and internal/external application of the bleaching agent.[7] However, hydrogen peroxide and carbamide peroxide(a combination of HP and urea) teeth whitening is extremely detrimental to the health of the oral mucosa and dentin. There are numerous occurrences, including oral mucosal burns[8] and allergies to dentin.[9] More than 0.1% hydrogen peroxide (HP) was not permitted in European markets as early as 2013.[10] F

urthermore, while sodium phytic acid[11,12], baking soda<sup>[13]</sup>, and sodium hypochlorite[14] are legal, the major efficacy of non-peroxide products is teeth cleaning rather than teeth whitening in a short period of time. It is wise to use a solution that is effective and has few side effects; nevertheless, when time is of the essence and the necessity for a faster shade shift outweighs worries about potential side effects, a doctor will use a higher concentration of bleaching agent.[15]Using polymer gel as the fine carrier[16-20], an efficient, peroxy caproic acid (PAP) based composite gel for teeth whitening was developed. According to the Spectro shade computerized spectrophotometry data, PAP had an equivalent tooth whitening impact to HP, and the composite gel with 12% PAP had the best whitening effect. More crucially, based on the scanning electron microscope (SEM) measurements and the volunteers' reports, PAP was found to be nearly safe and reliable to the teeth enamel, but HP would almost surely produce hypersensitivity and burning sensation.

PAP are considered an excellent substitute for tooth whitening solutions as compared to HP. The application of light or heat to activate the bleaching agent could speed up the in-office operations. Several types of activation devices, including as halogen curing lamps, plasma arc lamps, light-emitting diodes (LEDs), and lasers, are available to be used in conjunction with bleaching ingredients. The use of laser light promotes the release of free radicals in bleaching chemicals, resulting in a faster whitening process. Furthermore, it has been demonstrated that laser irradiation could minimize hypersensitivity of the teeth during the bleaching process.[21,22] One important concern about using the peroxide-based formulations is alteration in surface micromorphology and reduction in microhardness and calcium content of enamel.<sup>[23]</sup> It has been claimed that diode laser activation of peroxides during the bleaching process not only increases the whitening effect but also protects the change in enamel structure





Avneet Kaur et al.,

compared to that which occurs with gel treatment alone.<sup>[24]</sup> Hence, this study was planned to objectively evaluate and compare the clinical efficacy of teeth whitening system containing Phthalimidoperoxy caproic acid in conjunction with and without 810 nm diode laser.

## MATERIALS & METHODS

The study was approved by the Institutional Research Committee and Institutional Ethics committee (BVDU/IEC/R1/01/22-23). Patients visiting the Outpatient Department of Department of Periodontology, Bharati Vidyapeeth (Deemed to be University) Dental College and Hospital, Pune, having esthetic problem due to discoloration and intrinsic stains in anterior segment were selected with age range from 25-55 years. Detailed history and thorough clinical examination was carried out. Teeth with shades from A2- A3.5 were included in the study. None of the participant indicated presence of any systemic disease or allergic reaction to any component of the agents to be used. An intraoral examination confirmed that participant had no current caries activity, gingivitis, periodontal disease, defective enamel structure or restorations or any other oral pathology. Subjects with history of use any bleaching agents within the last year and with dentinal hypersensitivity were excluded. All the participants who were willing to participate were informed about all the procedures of the study and written informed consent was obtained from them. Study was a double blind randomized parallel study. The participants were assigned to one of two groups at random. Randomization was done with a sealed envelope system by a third person not involved in the trial. Selected subjects underwent Oral prophylaxis (scaling and polishing). The maxillary anterior teeth were then grouped into: Group A (left maxillary anteriors): treated with 24K Gold Tooth Whitening gel along with application of 810nm diode laser at 4 watt using teeth whitening prism in two cycles, each cycle lasting for 15 minutes (total exposure time being 30 minutes) and Group B (right maxillary anteriors) – treated with 24K Gold Tooth Whitening gel alone for 30 minutes. The total sample size for this study was 30 sites (15 per group). The application of gel was carried out with the use of applicator tip. Instructions were given to all the participants. Use of any other whitening products or consumption of teeth coloring food items like turmeric, coffee, black tea or red wine were strictly forbidden during the study<sup>[25]</sup>. They were asked to discontinue smoking or tobacco usage. After a period of 15 days, teeth whitening effect was checked using Vita classical shade guide. The shade change was evaluated and the data was coded into the nominal categories of 'yes' and 'no' Teeth whitening effect data was recorded and statistical analysis was then carried out. Descriptive statistics were expressed as numbers and percentages. The efficacy of the teeth whitening system with and without laser was compared using the Mann Whitney U test. In the above test, p-value less than or equal to 0.05 was considered statistically significant. All the analyses were conducted using SPSS version 25.

## RESULTS

Results indicated that anterior esthetic zone treated with phthalimido peroxy caproic acid and 810 nm diode laser (group A) showed change in shade for all the sites whereas teeth treated with phthalimido caproic acid alone (group B) showed 3 sites (20%) with shade change and remaining 12 sites (80%) with no change in shade.

## DISCUSSION

Laser-activated bleaching is the most recent advancement in power bleaching, providing speed and ease. Earlier used lasers were argon laser and CO<sub>2</sub>, but now, diode laser and potassium titanyl phosphate (KTP) are also used. Diode laser (810–980 nm) has proved to be less harmful and more effective with short application in the office.<sup>[15]</sup> A limited number of investigations have been published analyzing diode-laser efficacy using different PAP concentrations in the tooth-bleaching process. In the present study, the sample size taken is 30 sites (15 per group). Group A showed 15 sites with shade change and 0 sites with no change in shade. A study by Saluja I et al, 35% concentration of CP gave similar mean shade ( $\Delta E$ ) value at T<sub>2</sub>, as 15% CP at T<sub>3</sub>. At T<sub>3</sub>, 15% concentration of CP using



**Avneet Kaur et al.,**

diode laser for 2.5 min gave similar mean shade ( $\Delta E$ ) value, as 35% concentration of CP using diode laser for 2.5 min. 35% CP causes change in chroma and whitens the tooth at a faster rate with a significantly more lightening effect. When utilizing high or low CP concentrations, bleaching twice weekly yields a comparable effect. Laser-assisted bleaching decreases the time of whitening process.[26] In the present study, group B without laser showed 3 sites (20%) with shade change and the remaining 12 sites (80%) with no change in shade. Another study by Shahabi S et al, the results showed that all bleaching procedures were effective in reducing the yellowness index. However, the KTP laser-activated bleaching was significantly more effective than the other techniques in 95% confidence level. It was also discovered that the CO<sub>2</sub> laser activated approach outperformed groups E, F, and G, whereas traditional bleaching without light activation was ineffective and produced outcomes identical to the control group. Furthermore, the groups E and G achieved nearly identical outcomes in terms of decreasing the yellowness index. The results showed that all bleaching techniques were effective however, the KTP laser-activated bleaching was significantly more efficient, closely followed by the CO<sub>2</sub> laser-activated bleaching technique.[27] The purpose of power bleaching is to effectively whiten teeth while minimizing any negative effects on dental structures. Irradiation from a diode laser light source is anticipated to heat the CP, hence increasing the breakdown of hydrogen peroxide and the generation of hydroxyl and oxygen free radicals[28,29], resulting in a shorter treatment period and maybe improved treatment results. The results of this study showed that laser-assisted in-office bleaching had a faster and stronger whitening effect on stained demineralized teeth than the home bleaching procedure.

Many patients are interested in obtaining whiter teeth quickly, thus laser-assisted in-office bleaching could be recommended for them. There is some debate about the advantages of power bleaching over in-office bleaching without light activation. Son et al.<sup>[30]</sup> found that the diode laser irradiation improved the whitening effect of HP. Dominguez et al.<sup>[31]</sup> believed that for effective tooth whitening, the light source is more important than the bleaching agent. They discovered that activation with an LED light source was the best option since a significant color shift was produced with a small increase in pulp temperature. Several studies suggest that an improved color outcome is associated with longer bleaching time regardless of the bleaching agent's concentration.<sup>[31]</sup> Clinical evidence indicates that 10% CP is as effective as higher concentrations but results in a lower incidence of sensitivity than higher concentrations.<sup>[32]</sup> Mozghan Bizhang et al. in a study on non hydrogen peroxide bleaching agent concluded there were no significant differences at E<sub>0</sub>(pretreatment) between placebo and test groups regarding the tooth color. Differences in tooth color changes were calculated for both groups immediately after treatment (E1<sub>0</sub>) and 24 hours later (E2<sub>0</sub>). The mean values (standard deviations) of tooth color changes for E1<sub>0</sub> were 2.26 (0.92) in the test group and 0.01 (0.21) in the placebo group. The mean color changes for E2<sub>0</sub> were 2.15 (1.10) in the test group and 0.07 (0.35) in the placebo group. For E1<sub>0</sub> and E2<sub>0</sub> significant differences were found between the groups. The results showed that a non-hydrogen peroxide bleaching agent has significant whitening effects immediately and 24 hours after a single-use treatment.<sup>[33]</sup> Junyuan Qin et al. in another study on PAP showed that after using for 7 days, the whitening effect of dental whitening gels with 5% PAP were equivalent to the dental gels with 3% HP. Furthermore, when 12% PAP was used, the higher  $\Delta E$  values appeared, indicating that a higher concentration of PAP led to a better whitening effect. Moreover, it also showed that the whitening effect of 12% PAP is equivalent to 8% HP.

In addition, the linear ship between the  $\Delta E$  values and the usage days also indicated that the whitening effect of the tooth whitening composite gels with 12% PAP were more controllable. PAP was proved to be an efficient material for composite tooth whitening gels with peroxides and were much safer and more reliable than the commercialized HP based products.<sup>[34]</sup> However, Onwudiwe et al. evaluated the clinical efficacy and safety of 16% and 35% CP as in-office bleaching agents and concluded that 35% concentration achieved a lightening effect without additional side effects.<sup>[35]</sup> The longer the bleaching gel remains in contact with the tooth, the more it diffuses into the dental tissue, increasing the microporosities in the enamel, allowing the acid to penetrate deeper into its structure, oxidizing more stain-containing molecules, and resulting in an improved whiter effect.<sup>[36]</sup> A study concluded that diode laser activation of bleaching agent presented significantly better results than the agent used alone or when combined with the LED source. An added advantage is the bleaching agent's reduced contact time with the teeth, which minimizes the chances of sensitivity or irritation.<sup>[37]</sup> When the light of a specific wavelength is used that approximates the bleaching agent's absorption spectrum, the chemical reaction proceeds faster, thereby decreasing the exposure time





**Avneet Kaur et al.,**

of the bleaching agent to the tooth.[38,39] According to Klunboot et al., diode laser at low-power densities was highly efficient in tooth bleaching.[40]

## CONCLUSION

Bleaching agent showed better results when used with laser compared to when used without laser. Laser bleaching can be deemed as a more efficient technique for esthetic improvement.

## REFERENCES

1. Fornaini C, Lagori G, Merigo E. et al. Analysis of shade, temperature and hydrogen peroxide concentration during dental bleaching: in vitro study with the KTP and diode lasers. *Lasers Med Sci.* 2013;28(1):1–6
2. Burrows S. A review of the efficacy of tooth bleaching. *Dent Update.* 2009;36(9):537–538, 541.
3. Matis BA, Cochran MA, Eckert G. Review of the effectiveness of various tooth whitening systems. *Oper Dent.* 2009;34(2):230–235.
4. Mondelli RF, Azevedo JF, Francisconi AC, Almeida CM, Ishikiriama SK. Comparative clinical study of the effectiveness of different dental bleaching methods - two year follow-up. *J Appl Oral Sci.* 2012;20(4):435–443
5. Joiner A. The bleaching of teeth: a review of the literature. *J Dent.* 2006;34(7):412–419.
6. Rezende M, Ferri L, Kossatz S, Loguercio AD, Reis A. Combined bleaching technique using low and high hydrogen peroxide in-office bleaching gel. *Oper Dent.* 2016;41:388–96
7. Pare S, Loganathan S. Vital bleaching with diode laser. *Indian J Dent Res.* 2012;2:532–4.
8. K. Shetty, Hydrogen peroxide burn of the oral mucosa, *Ann. Pharmacother.* 40(2006) 351–351.
9. K. Marvin, Bright, white, and sensitive: an overview of tooth whitening and dentin hypersensitivity, *Dent. Today* 27 (2008) 80–81.
10. H. Beckett, H<sub>2</sub>O<sub>2</sub> and the law, *Br. Dent. J.* 208 (2010) 273–274.
11. H. Nakauchi, Y. Eshita, Tooth Whitening Composition Containing Phytic Acid and Peroxide, and Tooth-Whitening Method, JP patent 2018039850, March 2018.
12. G. Nakauchi, Y. Eshita, K. Takahashi, Tooth Whitening Agents Containing Phytic Acid and Orthophosphoric Acid or Polyphosphoric Acid, and Method for Whitening Tooth, WO patent 2014069594, May 2014.
13. B.O. Tostes, R.F.L. Mondelli, Y.B.O. Lima-Arsati, J.A. Rodrigues, L.C. Costa, The effect of baking soda when applied to bleached enamel prior to restorative treatment, *Gen. Dent.* 61 (2013) 5–9.
14. C.V. Bhausaheb, P.A. Manohar, G.P. Namdeo, Adverse reaction of sodium hypochlorite during endodontic treatment of primary teeth, *J. Clin. Pediatr. Dent.* 8(2015) 153–156.
15. Wetter NU, Barroso MC, Pelino JE. (2004): Dental bleaching efficacy with diode laser and led irradiation: An in vitro study. *Lasers in Surgery and Medicine*, 35:254-258.
16. Z. Huang, L. Li, Y. Wang, C. Zhang, T. Liu, Polyaniline/graphene nanocomposites towards high-performance supercapacitors: a review, *Compos. Commun.* 8 (2018) 83–91.
17. F. Zhang, Y. Feng, M. Qin, T. Ji, F. Lv, Z. Li, L. Gao, P. Long, F. Zhao, W. Feng, Stress-sensitive thermally conductive elastic nanocomposite based on interconnected graphite welded carbon nanotube sponges, *Carbon* 145 (2019) 378–388.
18. D.P. Dubal, K. Jayaramulu, J. Sunil, Š. Kment, P. Gomez-Romero, C. Narayana, R. Zbořil, R.A. Fischer, Metal-organic framework (MOF) derived electrodes with robust and fast lithium storage for Li-ion hybrid capacitors, *Adv. Funct. Mater.* 28(2018) 1805053.
19. Z. Zhang, J. Qu, Y. Feng, W. Feng, Assembly of graphene-aligned polymer composites for thermal conductive applications, *Compos. Commun.* 8 (2018) 33–41.
20. R. Zeng, H. Deng, Y. Xiao, J. Huang, K. Yuan, Y. Chen, Cross-linked graphene/carbon nanotube networks with polydopamine “glue” for flexible supercapacitors, *Compos. Commun.* 8 (2018) 73–80.





## Avneet Kaur et al.,

21. Ghanbarzadeh M, Ahrari F, Akbari M, Hamzei H. (2015): Microhardness of demineralized enamel following home bleaching and laser-assisted in office bleaching. *Journal of Clinical and Experimental Dentistry*,7:e405-409
22. Berger SB, Cavalli V, Ambrosano GM, Giannini M. (2010): Changes in surface morphology and mineralization level of human enamel following in-office bleaching with 35% hydrogen peroxide and light irradiation. *General Dentistry*,58:e74-79.
23. Son JH, An JH, Kim BK, Hwang IN, et al. (2012): Effect of laser irradiation on crystalline structure of enamel surface during whitening treatment with hydrogen peroxide. *Journal of Dentistry*,40:941-948.
24. Hahn P, Schondelmaier N, Wolkewitz M, Altenburger MJ, Polydorou O. Efficacy of tooth bleaching with and without light activation and its effect on the pulp temperature: An in vitro study. *Odontology*. 2013;101:67–74.
25. Bizangh (2016) Effectiveness of a new non-hydrogen peroxide bleaching agent after single use - a double-blind placebo controlled short-term study
26. Saluja I, Shetty N, Shenoy R, Pangal SN. Evaluation of the efficacy of diode laser in bleaching of the tooth at different time intervals using spectrophotometer: An in vitro study. *J Conserv Dent*. 2022 Mar-Apr;25(2):166-172.
27. Shahabi S, Assadian H, Mahmoudi Nahavandi A, Nokhbatolfoghahaei H. Comparison of Tooth Color Change After Bleaching With Conventional and Different Light-Activated Methods. *J Lasers Med Sci*. 2018 Winter;9(1):27-31.
28. Poosti M, Ahrari F, Moosavi H, Najjaran H. (2014): The effect of fractional CO2 laser irradiation on remineralization of enamel white spot lesions. *Lasers in Medical Science*,29:1349-1355.
29. Sulieman M, MacDonald E, Rees JS, Addy M. (2005): Comparison of three in-office bleaching systems based on 35% hydrogen peroxide with different light activators. *American Journal of Dentistry*,18:194-197
30. Son JH, An JH, Kim BK, Hwang IN, et al. (2012): Effect of laser irradiation on crystalline structure of enamel surface during whitening treatment with hydrogen peroxide. *Journal of Dentistry*,40:941-948.
31. Domínguez A, García JA, Costela A, Gómez C. (2011): Influence of the light source and bleaching gel on the efficacy of the tooth whitening process. *Photomedicine and Laser Surgery*,29:53-59.
32. de Geus JL, Wambier LM, Boing TF, Loguercio AD, Reis A. At-home bleaching with 10% vs.more concentrated carbamide peroxide gels: A systematic review and meta-analysis. *Oper Dent*. 2018;43:E210–22.
33. Bizhang M, Domin J, Danesh G, Zimmer S. Effectiveness of a new non-hydrogen peroxide bleaching agent after single use - a double-blind placebo-controlled short-term study. *J Appl Oral Sci*. 2017 Sep-Oct;25(5):575-584. doi: 10.1590/1678-7757-2016-0463. PMID: 29069156; PMCID: PMC5804394.
34. Qin, Junyuan& Zeng, Li & Min, Wei & Tan, Licheng&Lv, Ruizhi & Chen, Yiwang. (2019). A bio-safety tooth-whitening composite gels with novel Phthalimidoperoxy caproic acid. *Composites Communications*. 13. 10.1016/j.coco.2019.04.002.
35. Matis BA, Mousa HN, Cochran MA, Eckert GJ. Clinical evaluation of bleaching agents of different concentrations. *Quintessence Int*. 2000;31:303–10.
36. Onwudiwe UV, Umesi DC, Orenuga OO, Shaba OP. Clinical evaluation of 16% and 35% phthalimidoperoxy caproic acid as in-office vital tooth whitening agents. *Nig Q J Hosp Med*. 2013;23:80–4.
37. El-Murr J, Ruel D, St-Georges AJ. Effects of external bleaching on restorative materials: A review. *J Can Dent Assoc*. 2011;77:b59.
38. Wetter NU, Barroso MC, Pelino JE. Dental bleaching efficacy with diode laser and LED irradiation: An in vitro study. *Lasers Surg Med*. 2004;35:254–8.
39. Convissar R. St. Louis, Missouri: Elsevier Mosby; 2012. Principles and Practice of Laser Dentistry; pp. 150–1
40. Klunboot U, Arayathanitkul K, Chitaree R, Emarat N. Effect of Diode Laser on Teeth Enamel in the Teeth Whitening Treatment. In: Asia Communications and Photonics Conference and Exhibition. *Journal of the Optical Society of America*. 2011:83111H.

**Table 1: Recorded data of shade change pre and post treatment.**

Study groups	Number of participants	Shade(pre-treatment)	Shade(post-treatment)
Group A(with laser)	6	A2	A1







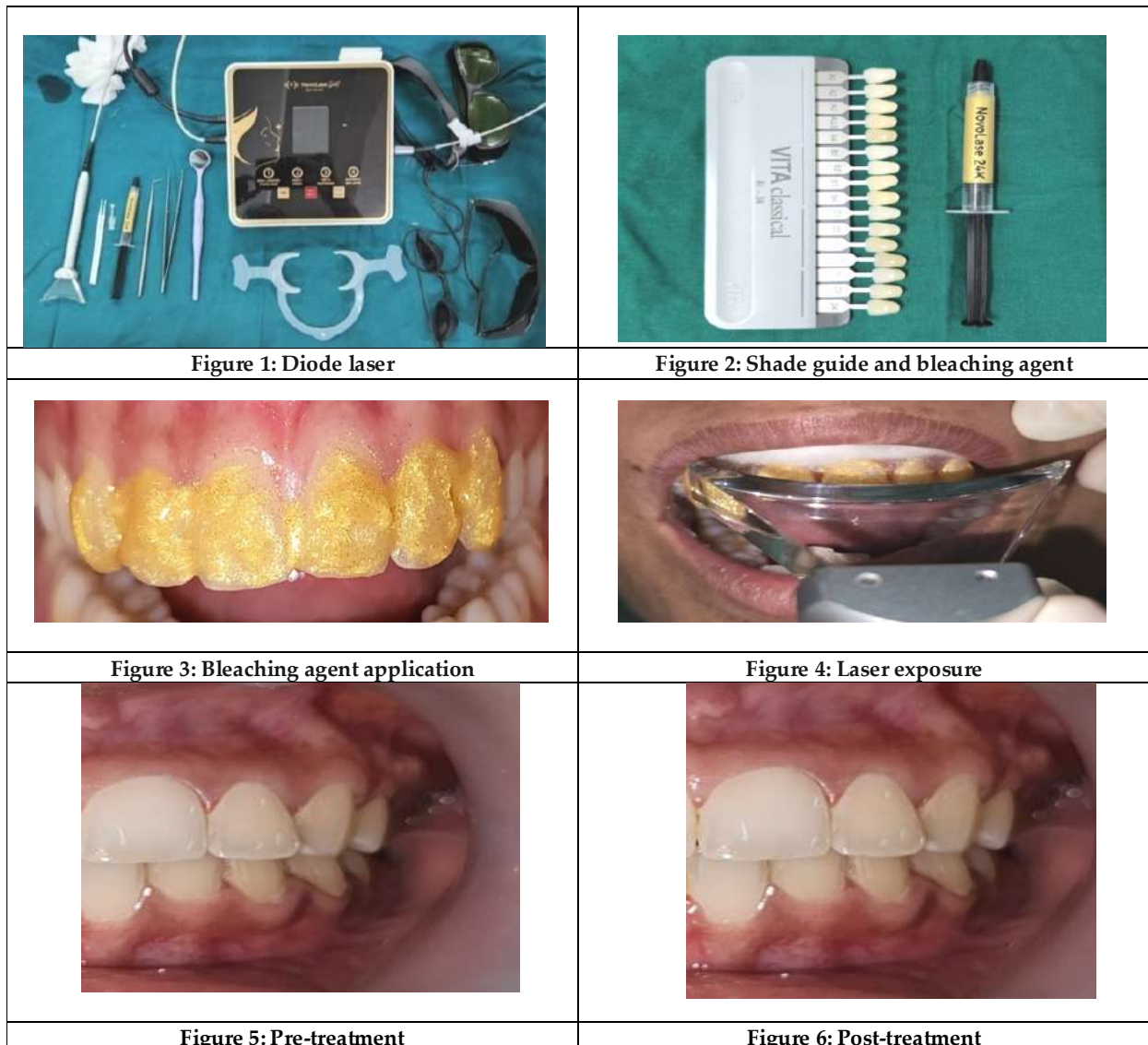
Avneet Kaur et al.,

	6	A3	A2(5), A1(1)
	3	A3.5	A2(2), A3(1)
Group B(without laser)	6	A2	A2
	6	A3	A3(5), A2(1)
	3	A3.5	A3.5(1), A3(2)

Table 2: Comparison of the efficacy of teeth whitening agent with and without laser

	Shade change (yes)	No shade change (no)	P value (Mann Whitney U test)
Group A (with laser)	15 (100%)	0	<0.001*
Group B (without laser)	3 (20%)	12 (80%)	

\*p≤ 0.05 is statistically significant





Avneet Kaur et al.,



Figure 7: Pre-treatment



Figure 8: Post-treatment





## A Philosophical Analysis of the Relationship between Individual and Society

S. Segar\*

Assistant Professor, Department of Philosophy, Madras Christian College, (Affiliated to University of Madras) Chennai, Tamil Nadu, India.

Received: 22 Jan 2024

Revised: 09 Feb 2024

Accepted: 03 May 2024

### \*Address for Correspondence

**S. Segar**

Assistant Professor,  
Department of Philosophy,  
Madras Christian College,  
(Affiliated to University of Madras)  
Chennai, Tamil Nadu, India.  
Email: segar@mcc.edu.in



This is an Open Access Journal / article distributed under the terms of the **Creative Commons Attribution License** (CC BY-NC-ND 3.0) which permits unrestricted use, distribution, and reproduction in any medium, provided the original work is properly cited. All rights reserved.

### ABSTRACT

The present article is a modest attempt to understand the relationship between individual and the society. Though individual and society are juxtaposed in the normal parlance but in reality, both are complementary and mutually inter-dependent. The methodology envisaged in the present article is descriptive and evaluative. To dislodge the relationship between individual and society social contract theory and organic theory were introduced. Also, the binaries such as egoism vs altruism, individual vs collectivity, personal values vs social values were considered for analysis. The article also emphasizes on the importance of society in substantiating morality and value system within the group. However, there is no reduction of individual to society and vice-versa were attempted and the scope for individuality and autonomy is adumbrated inspite of the inter-dependance between the two.

**Keywords:** social contract theory, organic theory, sociability of man, autonomy, social consciousness, norms, personal values, social values

### INTRODUCTION

Man is a social animal. He has a natural urge to live an associated life with others. Man needs society for his existence or survival. The human child depends on his parents and others for his survival and growth. The inherent capacities of the child can develop only in society. The ultimate goal of society is to promote good and happy life for its individuals. It creates conditions and opportunities for the all-round development of individual personality.





### Segar

Society ensures harmony and cooperation among individuals in spite of their occasional conflicts and tensions. If society helps the individuals in numerous ways, great men also contribute to society by their wisdom and experience. Thus, society and individuals are bound by an intimate and harmonious bond and the conflicts between the two are apparent and momentary. In a well-ordered society, there would be lasting harmony between the two. Aristotle, the Greek philosopher writes "Man is a social animal. He who lives without society is either a beast or God" [1]. To study the individual or group of individuals means to study the society. On the other hand the study of society implies the study of individuals. Individual is an unit of society but the individual also does not remain intact. The very existence of an individual is welded into the fabrics of society. An individual knows himself and his fellow beings within the framework of society. As Cooley states, "A separate individual is an abstraction unknown to experience and so likewise is a society when regarded as something apart from individual".<sup>2</sup> This clearly depicts the relationship between individual and the society. There are various approaches regarding the relationship between individual and society. Traditionally, two theories namely the social contract theory and the organic theory have explained the relationship between the individual and society. According to social contract theory, the individuals are born free and equal in his state of nature. Society is the result of an agreement entered into by men who originally lived in a pre-social state. And because society is made by man he is more real than his creation. Society is mere aggregation of individuals. On the other hand, the organic theory stated that the society is an organism. Just as the parts of an animal body are functionally related and none can exist isolated from the rest. So the members of a social body are functionally related to each other and to the society as a whole. Therefore, society is more real than the individual and is greater than the sum of its individual members. As Park says, "Man is not born human but to be made human".<sup>3</sup> No human being is known to have normally developed in isolation. If the child is abstracted from contact with his fellows at birth, it will grow up into a feral man without knowledge of human speech, without any concept of 'right' and 'wrong'. It makes one thing very clear that an individual's human nature is dependent upon his or her membership in a society. It is supported by a number of case studies. For example, the 'Wolf-Children' of India, Amala and Kamala. When the sisters were rescued from the wolf's den, they showed wolf-like behavior. They would not allow themselves to be dressed, rejected cooked food and walked on all fours.

They appeared to show no human emotions of any kind, apart from fear. All this tends to show that no human being can normally develop in isolation. Every individual is thus the product of social relationship. An individual is born to a society which moulds his attitudes, his beliefs and his ideals. At the same time society also grows and changes in accordance with the changing attitudes and ideals of its members. Today we are in the postindustrial society. We came to this stage by passing barbarian, agrarian and industrial society. This is nothing but the development of society. This development is possible only by the intellectuals who lived in this period. Social life can have no meaning except as the expression of the lives of the individuals. Society has meaning to the individual only because it supports and contributes to the ends, the purposes of individuals themselves. It is these ends which gives society a unity. For example, each individual has the desire to have a happy and pleasurable life. Society makes an individual to attain his desire. It is by helping the development of individuality of the individual that society achieves its purpose and significance. Thus, there is a close relationship between individual and society. As MacIver says, "Individuality in the sociological sense is that attribute which reveals the member of a group as more than merely a member."<sup>4</sup> According to MacIver, "in the real world of man, society and individuality go hand in hand."<sup>5</sup> It would be however misleading to say that there exists complete harmony between individuality and society. Society is a system of relations among individuals. The system moulds our attitudes, beliefs and our ideals. This does not mean that individuals belong to society as the leaves belong to the trees or the cells to the body. The relations between the individual and society are closer.

#### Sociability of Man

It was Aristotle who stated that man is a social animal. This proposition leads to the sociability of man or the sociality of man. The fact is that man is always belongs to a society or a group and without which he cannot live. The relationship between individual and society is one of the most fundamental problems of social philosophy. In fact, it is philosophical problem because it involves the question of values. In the relationship of individual and society, we





### Segar

see ourselves on one side and our society on the other side. In short, the person on one side and the group on the other side, that is the individual and the collectivity.

#### **Man depends on society**

It is a common observation of everyone that the individual is breathing, playing, resting and in short doing everything in society. It is in the society that the character of an individual is moulded by culture, a societal force. It is only in the society that an individual has to conform to the norms, occupy a status, play a role and become member of a group. Then what is the role and responsibility of an individual to himself and to his society? Is the individual lost in society, or is it only in society that he can find himself. It is an apparent fact that an individual has not only a capacity for social life but also an intrinsic need of it. Emotional development, intellectual maturity and a certain amount of material goods and comforts are unthinkable without society. An individual can attain his real nature only in society. The psychological development of the social consciousness of the child is also a confirmation of the natural sociability of the human being.

#### **Man in Society and Society in Man**

Everywhere an individual is a member of group. The isolated individual does not exist. The language we speak, the dress we wear, the ideals we cherish and the morality, ethics we follow in our life are derived from our culture. Culture is a socialization force. Society surrounds us in our infancy to our resting place. We depend upon society. According to Peter L. Berger, "Society not only controls our movements, but shapes our identity, our thought and our emotions. The structures of society become the structures of our own consciousness."<sup>6</sup> Society penetrates us as much as it environs us. Our bondage to society is not simple but complex. Durkheim stated that society confronts us as an objective facticity. It is there something that cannot be denied and that must be reckoned with. Society is external to ourselves. It encompasses our entire life. We are in society, located in specific sectors of the social system. Our wishes are not taken into consideration in the matter of social location. The institutions of society pattern our actions and even shape our expectations. We are located in society not only in space but also in time. Our society is an historical entity that extends beyond the temporary life of any individual.

#### **The Inseparable Individual and the Society**

The relation between an individual and society is not merely a physical unity, or a functional unity, or organic unity, but it is something more than these. It is simply social, that is, without the company of his fellowmen, an individual cannot live, cannot develop his personality. It means an individual always need the presence of other human being for having a pleasurable life and developing his personality. But now I have to mention one more thing. That is, whatever mentioned above is not the only character of an individual. Rather, an individual has a life of his own, his autonomy and character which cannot be fused or confused with the lives of other men. An individual has the autonomy to decide whether he can share his emotional feeling with others or not. An individual gets the culture, ethics, morality, etc. from the society. But at the same time the way in which he understands all these things depends on his character and capacity. It is the fact that different people understand one and the same thing in different way according to their character and capacity. Sometime, he may not accept a particular element of culture or morality and he may think in other way. After sometime, that will become the standard. For example, Raja Ram Mohun Roy was not happy with the practice of Sati. He thought of it in different way that led to the abolition of sati in our country. So, sometime, the society may get something from an individual. Social values are in the ultimate analysis personal values. Even quality or powers which belong to society as such are realized only in its members. The economic standard of a country can be understood only by analyzing the economic condition of individual.

#### **Scope for individuality**

We need society in order to become persons. But society is not a great engine of which we are merely a mechanical part. It is not a giant organism in which we are only a microscopic cell. Society is unique to itself. Robert Bierstadt stated that from the society we receive the gift of individuality and in it we express our personality. It means that we develop our individuality only in the society and we show our inner talents and capacity only in the society. Even in society we are always, in some sense, alone. There is always a part of us that we never share, a thought that is





### Segar

uncommunicated, and a dream that stays in its private chamber. In our day to day life we are not sharing all our feeling and emotions with others. Rather, an individual share only a selected portion of his feeling with selected people, not with all of others. Each and every individual has their personal life which is not shared with others. The same society and the same culture which limit the activities of man also liberate his energies and talents. Even if the culture moulds the character of an individual, it does not produce an individual like the carbon copies. No two individuals are exactly alike. The same culture may produce men of marvelous genius and men of matchless stupidity. The utterly selfish persons and the completely selfless individuals may be found in the same society. It clearly shows that there is the scope for individuality in the society. Every individual is unique to himself and his society. Different individuals may react to the same stimuli in different ways because of their individuality. This individuality is the gift of society. But individuals become individuals only in society. Society is a relation among individuals. It is the sum of individuals who are in a state of interaction. But this interaction creates something which is more than the sum of individuals. And it is this interaction which differentiates society from the mere aggregation of individuals. Thus, there is a fundamental and dynamic interdependence of individual and society. The only experience that we know is the experience of individuals. All thoughts or feelings are experienced by individuals. Feelings or thoughts are like, but not common. There is no common will of society. When we say that a group has a common mind or common will it means that there are tendencies to thought, feeling and action, widely dominant in group. These tendencies are due to their past interaction and present relations. But these tendencies do not form a single mind, single will or purpose. Society cannot have a mind or will of its own. It is only in the light of our interests, our aspirations, our hopes and fears, that we can assign any function and any goal to society. Conversely individuals have interests, aspirations, goals only because they are a part of society. To quote Ginsberg, Society is the condition of his having any ends at all since social life moulds all his ideals and gives definiteness and form to all his impulses. It follows that the relationship between individual and society is not one-sided.

### CONCLUSION

It may be concluded that individual and society are interdependent. It is only in the society an individual is enjoying everything. Today we are in the technological world. We are using Wi-Fi, mobile, transportation, and other luxurious items are no doubt given by the society. But one thing I have to clarify. All these things are not invented or created by the society. Rather it is invented or created by an individual. It is due to the creative work of an individual. So, neither the individuals belong to society as cells belong to the organism, nor the society is a mere contrivance to satisfy certain human needs. The individual and society interact to one another and depended on one another. Both are complementary and supplementary to each other.

### REFERENCES

1. G. Sreedathan, World Political Thought and Theories, P.6.
2. Glenn Jacobs, Charles Horton Cooley: Imagining Social Reality, Boston, P.59.
3. ShamaLohumi& Rakesh Lohumi, Sociology for Nurses, p.16
4. MacIver & Page, Society: An Introductory Analysis, P.50.
5. ShamaLohumi& Rakesh Lohumi, Sociology for Nurses, p.17
6. C.N. Shankar Rao, Sociology: Principles of Sociology with an introduction to Social Thought, P.161.
7. G. Sreedathan, *World Political Thought and Theories*, New Delhi: Deep & Deep Publications Pvt. Ltd, 2006.
8. Glenn Jacobs, *Charles Horton Cooley: Imagining Social Reality*, Boston: University of Massachusetts Press, 2006.
9. MacIver & Page, *Society: An Introductory Analysis*, California: University of California Press, 2007.
10. ShamaLohumi& Rakesh Lohumi, *Sociology for Nurses*, New Delhi: Reed Elsevier Pvt. Ltd., 2015.
11. C.N. Shankar Rao, *Sociology: Principles of Sociology with an introduction to Social Thought*, New Delhi: S. Chand & company, 2011.
12. C.N. Shankar Rao, *Sociology: Primary Principles Of Sociology*, New Delhi: S. Chand& Company, 2006





**Segar**

13. R.N. Sharma, *Principles of Sociology*, Bombay: Asia Publishing House, 1968.
14. Franklin Henry Giddings, *The Principles of Sociology*, New Delhi: Cosmo Publications, 2004.





## Emerging Green Warriors: Exploring the Disposition of Kerala Youth towards Sustainable Products

Shiji P<sup>1\*</sup> and Edakkotte Shaji<sup>2\*</sup>

<sup>1</sup>Research Scholar, Government Arts and Science College, Meenchanda and Assistant Professor, Providence Women's College, Department of Commerce, (Affiliated to University of Calicut) Kozhikode, Kerala, India.

<sup>2</sup>Associate Professor, Department of Commerce, Government Arts and Science College (Affiliated to University of Calicut) Kozhikode, Kerala, India.

Received: 30 Jan 2024

Revised: 09 Feb 2024

Accepted: 26 Apr 2024

### \*Address for Correspondence

#### Shiji P

Research Scholar,  
Government Arts and Science College,  
Meenchanda and Assistant Professor,  
Providence Women's College,  
Department of Commerce,  
(Affiliated to University of Calicut)  
Kozhikode, Kerala, India.  
Email: Shijip.sunil@gmail.com

#### Edakkotte Shaji

Associate Professor,  
Department of Commerce,  
Government Arts and Science College  
(Affiliated to University of Calicut)  
Kozhikode, Kerala, India.  
Email: shajisanjeev@gmail.com



This is an Open Access Journal / article distributed under the terms of the **Creative Commons Attribution License** (CC BY-NC-ND 3.0) which permits unrestricted use, distribution, and reproduction in any medium, provided the original work is properly cited. All rights reserved.

### ABSTRACT

The study aims to see the sights on the disposition of youth towards the acquisition of environmentally-friendly items in the context of Kerala, India. The primary objective was to assess the extent of environmental consciousness and its potential influence on youths' positive attitudes towards sustainable products. A sample of 280 respondents was drawn from various regions across Kerala, including urban and rural areas, with an emphasis on individuals holding Bachelor's degrees or higher educational qualifications. The research utilized a measurement tool adapted from previous studies conducted in the field of green consumer behaviour. The study employed a measurement instrument derived from prior research in the realm of green consumer behaviour. Data Analysis methods includes Independent Sample t-tests, ANOVA, Correlation Coefficient and Regression Analysis were applied to scrutinize the disparities and connections among the variables. Contrary to expectations, the findings indicated that environmental consciousness did not significantly impact youths' attitudes towards green product purchases in the Kerala context. Furthermore, when analysing the responses of different demographic groups, including gender, age, and education levels, no significant differences in attitudes were observed. In conclusion, the study revealed that youngsters in Kerala demonstrated a lower level of environmental consciousness than initially anticipated, and this limited awareness did not appear to





**Shiji and Edakkotte Shaji**

significantly influence their attitudes toward green product purchases. These results suggest that there may be unique factors and challenges influencing green consumer behaviour in the Kerala region, warranting further investigation and tailored strategies to promote sustainable consumption practices.

**Keywords:** disposition, environmental consciousness, sustainable products, youth,

## INTRODUCTION

The level of consumers' environmental consciousness is a pressing concern in Kerala, as the state faces the ongoing challenge of environmental degradation. In response to this issue, educational institutions in Kerala, including schools, colleges, and universities, have introduced environmental education courses to instill higher levels of environmental consciousness among the younger generation. This approach aims to prepare students, who will later become expert practitioners in various places, to adopt green behaviours that can collaborate to a more sustainable and ecologically responsible economy within the state. Kerala, like many other regions, has experienced rapid population growth, which has exacerbated environmental problems. Additionally, the state has witnessed a significant contraction in the availability of natural resources, sounding an alarm for sustainability. Researchers in Kerala have increasingly focused their attention on the escalating issues related to resource depletion caused by excessive consumption. This consumption pattern not only exacerbates environmental problems but also poses a threat to biodiversity and the overall survival of the human population in the region. In the context of Kerala, it is vital to emphasize the unique environmental challenges and educational initiatives specific to the state while addressing the global concern of environmental consciousness and resource depletion.

A review of environmental awareness and consumer behaviour in developed countries reveals a notable shift towards eco-consciousness among their populations. This shift has led to a cleaner environment in comparison to developing nations. Notably, consumers in the United States and Europe express a willingness to pay a premium for sustainable products, reflecting their commitment to sustainable choices. In the context of Kerala, it has become increasingly evident that solely relying on excessive technological advancements for economic and technological growth is not a sustainable approach. It has been recognized that the use of sophisticated technology must be balanced with thoughtful planning to minimize any detrimental impact on the natural environment. One promising strategy, among several possible initiatives, is the integration of environmental education into the academic curriculum. This inclusion aims to raise environmental consciousness among students, thereby fostering positive dispositions toward environmentally friendly products. In the context of Kerala, this approach aligns with the state's rich biodiversity and environmental consciousness. Kerala, known for its lush landscapes and eco-friendly initiatives, already exhibits a strong inclination towards pro-environmentalism among the youth. However, research conducted in the state reveals that there are still variations among youngsters, with some being fervent believers in green purchasing practices while others remain less committed. In contrast, the neighbouring state of Karnataka is confronted with a distinct situation, characterized by a notable deficiency in environmental awareness within the populace that requires attention. This assessment forms the basis for the hypothesis of the current study in the Kerala context: a higher level of environmental consciousness leads to more positive dispositions toward green purchases, while a lower level of ecological knowledge may result in indifference or a negative disposition among consumers in the state.

## METHODOLOGY

### Sampling procedure

Convenience sampling was employed to gather data from individuals working in both government and private sector organizations across two districts in Kerala, India. A total of 300 participants were selected for the study, with



**Shiji and Edakkotte Shaji**

280 of them providing responses to the questionnaire. The sample comprised individuals with diverse demographic characteristics, incorporating individuals of both genders, and ages ranged from 18 to 40. Participants also represented diverse levels of educational attainment, spanning from undergraduate degrees to PhD qualifications. Among the respondents, 156 were male, while 124 were female. All participants received in-person visits by trained research personnel. Throughout these visits, the research team clarified relevant terminology and provided guidance on completing the surveys. This step was crucial to ensure that the participants understood the questions and could provide accurate responses.

**Measurement tool**

Given the nature of the research focused on analyzing disposition, the researchers conducted a thorough review of previous studies on green purchasing and disposition, leading to adopt a measurement tool that closely aligned with these studies. In order to gather replies, the researcher used a five-point Likert scale, which allowed respondents to indicate their levels of agreement.

**Analysis of Data**

Data collected were analysed using SPSS and statistical tools like the Independent Sample t-test, Correlation Coefficient and one-way ANOVA, were applied. Correlation was utilized to explore whether a statistically substantial relationship existed among environmental consciousness and the inclination toward Green Purchase. The Independent Sample t-test was used to investigate differences in disposition among masculine and feminine groups, while Analysis of Variance was employed to assess variations in dispositions across diverse age groups and educational levels.

**OUTCOMES**

The study suggests that there was no statistically notable correlation between Ecological consciousness and the tendency to engage in environmentally friendly buying. The Pearson Correlation value remained modest at 0.028, suggesting the lack of a substantial correlation between Ecological consciousness and the inclination towards sustainable consumption. Furthermore, the p-value (0.629) exceeded the significance level  $\alpha$  (0.05), underscoring that environmental consciousness did not exert any discernible influence on disposition towards green purchases. Consequently, based on this analysis, the initially proposed hypothesis had to be dismissed. The overall fit measuring tool, the Regression Co-efficient was found to be very low. The R Square value, standing at 0.001, and the adjusted R value, at -0.003, revealed that Ecological Knowledge reported for just 0.3% of the variability in the dependent variable. Thus, in this specific context, Ecological consciousness did not serve as an indicator of willingness to make sustainable acquisitions. An independent sample t-test was conducted to evaluate the variation in disposition between male and female respondents, using a significance level of 0.05. The outcome was 0.730, suggesting no noteworthy distinction in the replies of the two group. Both groups displayed a comparable average on the Likert scale (male group: 2.810, female group: 2.805), indicating a neutral position regarding green purchases. ANOVA was utilized to explore the variation in disposition across demographics. The mean values for dissimilar age groups and education levels were consistently around 3. The F values, 0.879 for age and 1.501 for education, were both below the critical F-value which indicates that there was no significant difference among various age groups or education levels, and no specific group exhibited a stronger inclination towards green purchases. However, a noteworthy finding in the ANOVA test was a slight improvement in the mean of disposition towards Green Purchase as education levels increased. This underscores the role of educational programs in enhancing environmental awareness, which appears to be crucial in shaping a positive disposition towards sustainable products in the context of Kerala.

**DISCUSSIONS**

The current study aimed to investigate youths' disposition to sustainable products in the Kerala. Diverging from expectations set by studies in other countries, which anticipated that consumers possessing greater ecological



**Shiji and Edakkotte Shaji**

knowledge and awareness of sustainable products would demonstrate a willingness to purchase such items and potentially pay a premium for their perceived benefits, the outcomes of this particular study did not align with these established findings. This discrepancy could be attributed to financial constraints and a general lack of environmental consciousness in the Kerala region. A study conducted by Singh and Rajan (2018), which investigated consumer attitudes towards eco-friendly products in South India, including Kerala. The study found that, despite a global rise in environmental consciousness, consumers in Kerala exhibited a lower inclination towards adopting eco-friendly products. Despite economic and cultural advancements, the young consumers in Kerala did not exhibit a robustness in sustainable goods. This opposes the outcomes of Dunlap (1994), who contended that in advanced nations through access to material and advanced technology, consumers tend to be more inclined toward Green Practices related to citizens in less advanced regions, where individuals are primarily focused on meeting their basic needs. By integrating Dunlap's (1994) perspective, the discussion can evolve to encompass the global dynamics of consumer behaviour, highlighting how economic, technological, and cultural factors may influence sustainability preferences in both developed and less developed regions, challenging conventional expectations.

The ongoing research aligns with a distinct investigation, this time drawing parallels with a study conducted in a European context. In this European study, a similar trend of a moderately improved response in consumers' awareness of sustainable products was identified. Just as observed in the Chinese study, European consumers exhibited a comparatively better understanding of sustainable products than some of their Western counterparts. However, akin to the limitations noted in the Chinese study, the volume of sustainable product purchases in the European context remained constrained (Smith, 2002; Johnson, 2005). This comparative analysis highlights the universality of the observed pattern, transcending regional boundaries. The parallel trends suggest that the challenge of bridging the gap between consumer awareness and actual sustainable product consumption is a pervasive phenomenon. This consistency across diverse geographical and cultural contexts underscores the complexity of the factors influencing sustainable consumer behaviour. As a seasoned research guide, it's apparent that the emphasis should now shift towards a more holistic examination of the common underlying barriers to widespread adoption of sustainable products. By exploring these shared challenges, researchers and practitioners can collaboratively devise targeted strategies that go beyond cultural nuances to encourage more substantial and impactful sustainable consumption patterns on a global scale. Nevertheless, the study recommended that the government and regulatory authorities in Kerala take corrective measures to enhance environmental consciousness through education and training, similar to the suggestions made in the Chinese context.

**REFERENCES**

1. Akter, S., & Islam, S. (n.d.). FACTORS INFLUENCING THE ATTITUDE OF WOMEN TOWARDS PURCHASING GREEN PRODUCTS: AN EXPLORATIVE CASE STUDY OF ORGANIC COSMETICS IN SWEDEN. *Journal of Consumer Sciences*, 48, 2020.
2. Basha, M. B., Mason, C., Shamsudin, M. F., Hussain, H. I., & Salem, M. A. (2015). Consumers Attitude Towards Organic Food. *Procedia Economics and Finance*, 31, 444–452. [https://doi.org/10.1016/s2212-5671\(15\)01219-8](https://doi.org/10.1016/s2212-5671(15)01219-8)
3. Bellows, A. C., Alcaraz V., G., & Hallman, W. K. (2010). Gender and food, a study of attitudes in the USA towards organic, local, U.S. grown, and GM-free foods. *Appetite*, 55(3), 540–550. <https://doi.org/10.1016/j.appet.2010.09.002>
4. Boys, K. A., & Fraser, A. M. (2019). Linking small fruit and vegetable farmers and institutional foodservice operations: Marketing challenges and considerations. *Renewable Agriculture and Food Systems*, 34(3), 226–238. <https://doi.org/10.1017/S1742170518000030>
5. Govender, J., & L. Govender, T. (2016). The influence of green marketing on consumer purchase behavior. *Environmental Economics*, 7(2), 77–85. [https://doi.org/10.21511/ee.07\(2\).2016.8](https://doi.org/10.21511/ee.07(2).2016.8)
6. Proctor, Felicity., International Institute for Environment and Development., & HIVOS (Organization). (2012). *Small-scale farming and youth in an era of rapid rural change*. Knowledge Programme Small Producer Agency in the Globalised Market.





**Shiji and Edakkotte Shaji**

7. Sriwaranun, Y. (2011). AN EMPIRICAL ANALYSIS OF CONSUMERS PURCHASING BEHAVIOUR TOWARDS ORGANIC PRODUCTS IN THAILAND.

**Table 1. Association between Independent Variables and the Dependant Variables**

Variables		Disposition towards sustainable products
Environmental consciousness	Pearson correlations	.028
	Sig.(2- tailed)	.629
	N	280

Source: Primary Data

**Table 2. Environmental consciousness and disposition towards sustainable products (Regression Analysis)**

Model Summary					
Mode	R	R Square	Adjusted R square	Sig	Standardised Coefficients
1					
1	.028	.001	-.003	.639	.028

Source: Primary Data

**Table 3. Analysis of differences in attitudes between male and female respondents. (independent sample t-test)**

Disposition	Group	Mean	SD	P Value
	Male	2.810	.5500	.730
	Female	2.805	.5520	

Source: Primary Data

**Table 4. Analysis of Variance of disposition in relation to demographic factors, i.e., Age and Education**

Age Groups	Mean	F	Sig.
21-30	2.810	.879	.471
31-40	2.890		
41-50	2.765		
51-60	2.7		
61-70	2.95		
<b>Total</b>	2.822		

Education Groups	Mean	F	Sig.
Under Graduate	2.900	1.501	.222
Post Graduate	2.820		
Phd	2.730		
<b>Total</b>	2.817		

Source: Primary Data





## Chakramard Plant (*Cassia tora* L.) in the form of Lepa or Tail as Local Application in the Management of *Dadru Kushtha* (Tinea Infection) – A Systematic Review

Anuradha Indrajit Khandekar<sup>1</sup>, Satya Lakshmi Komarraju<sup>2</sup>, Sathyanaath D<sup>3</sup> and Shrikanth Muralidharan<sup>4\*</sup>

<sup>1</sup>Medical Officer, Department of Arogyadham, Centre of Alternative Medicine, Gujarat, (Affiliated to Kasturba Health Society) Wardha, Maharashtra, India.

<sup>2</sup>Director, National Institute of Naturopathy, Pune, India.

<sup>3</sup>Senior Medical Officer, National Institute of Naturopathy, Pune, Maharashtra, India.

<sup>4</sup>Clinical Research Course Coordinator, Department of Research, National Institute of Naturopathy, Pune, India.

Received: 22 Jan 2024

Revised: 09 Feb 2024

Accepted: 29 Apr 2024

### \*Address for Correspondence

**Shrikanth Muralidharan**

Clinical Research Course Coordinator,

Department of Research,

National Institute of Naturopathy,

Pune, India.

Email: shrikanthmuralidharan23@gmail.com



This is an Open Access Journal / article distributed under the terms of the **Creative Commons Attribution License** (CC BY-NC-ND 3.0) which permits unrestricted use, distribution, and reproduction in any medium, provided the original work is properly cited. All rights reserved.

### ABSTRACT

Ayurveda describes most skin diseases under the category of *Kushta*. *Dadru* (Tinea infection) is a subtype of *Kushta* that affects the skin resulting in discoloration, itching etc. The clinical application of the *Chakramard* plant, (*Cassia Tora* L.) in the form of *tailor lepa* as local application, has shown promise in various studies. Therefore, this systematic review aims to investigate the effectiveness of *Chakramard* plant interventions in treating *Dadru* (Tinea infection). The systematic review suggests that *Chakramard* plant interventions hold promise in managing the symptoms of *Dadru Kushtha*. However, the limitations in study design, lack of control groups, short follow-up periods, and limited discussions on safety profiles should be addressed in future research.

**Keywords:** *Dadru*, *Kushtha*, *Chakramard taila*, *Cassia Tora* L.





## INTRODUCTION

Skin diseases have long been a concern for human health. Known as *Kushta, Dadru* (Tinea infection) is a specific and most severely encountered one [1]. This condition disrupts the skin's equilibrium and manifests as skin discoloration. As per the natural understanding of the disease progression, this skin lesion is attributed to consuming untimely, excessive, unwholesome, or imbalanced food, resulting in weakened digestion [2, 3]. It leads to the generation of undigested residue, which subsequently putrefies. Other contributing factors include behaviors detrimental to well-being, such as suppressing natural urges, excessive exertion after consuming oily foods, and staying awake during nighttime, all deviating from the principles of a healthy lifestyle [4-7]. Shifting lifestyles and dietary habits have led to a surge in cases. Skin-related diseases, including fungal infections like Tinea, constitute a significant portion of medical ailments. The global prevalence of ringworm, a Tinea infection, underscores the urgency of addressing it through alternative means to tackle the problem [7-9]. In this context, using the *Chakramard* plant (Cassia Tora L.) offers potential solutions. This plant belongs to the Caesalpiniaceae family and is known for its analgesic, antipyretic, antifungal, and hepatoprotective properties. Its various components contribute to its medicinal attributes, including antibacterial, anti-platelet aggregation, and antioxidant activities. The multifaceted approach, encompassing lifestyle modifications and plant-based interventions like Cassia Tora L., holds promise in providing holistic solutions to this pressing health concern. Therefore, this systematic review aims to investigate the effectiveness of the external application of the Cassia Tora plant oil/powder in treating Tinea infection in the Indian set-up.

## RESEARCH QUESTION

Does using Cassia Tora plant oil/powder interventions offer a practical and natural approach to treating Tinea infection? We hypothesize that this external application effectively manages the skin lesion, offering a cost-effective and natural approach to its treatment.

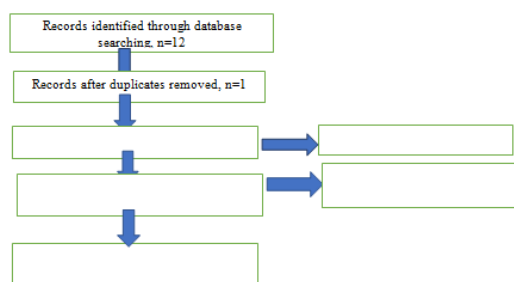
## METHODOLOGY

A well-defined protocol was developed before initiating the review. This protocol outlined the research question, objectives, eligibility criteria, search strategy, data extraction methods, and analysis procedures. The protocol was registered with the OSF registries.

### SEARCH STRATEGY

One author conducted a systematic literature search using electronic databases, including PubMed, Google Scholar, and the AYUSH Research Portal. The search strategy involved using specific keywords related to Tinea infection, Cassia Tora plant oil, powder or any other form of topical application, and India. The search period covered studies published within the last decade (from 2012 to 2022).

### PRISMA Flow chart





**Anuradha Indrajit Khandekar et al.,**

The study selection process involved two stages. In the initial stage, titles and abstracts of identified studies were screened for relevance. Subsequently, full-text articles were assessed against the predefined inclusion and exclusion criteria. Any discrepancies or uncertainties during the screening process were resolved through discussion among the authors. Free full-text studies investigating the effectiveness of Cassia Tora plant-based treatments administered as topical ointment were included for analysis. Control interventions, where available, were also included for comparison. One author systematically conducted the data extraction process, capturing relevant information from each included study. Details recorded during data extraction included study design, participant characteristics (such as age and gender distribution), intervention protocols, outcome measures, and reported results. After data extraction, the extracted data were independently verified by other authors to ensure accuracy and consistency. No formal risk of bias assessment tool was applied due to the heterogeneity in study designs and the absence of control groups in some studies. No attempts were made to contact the study authors for additional information or clarifications. Data extraction and analysis were based solely on the information available in the published studies.

## RESULTS

The systematic review included four eligible research articles focused on Ayurvedic management of *Tenia* infection. The studies employed different sampling designs, sample sizes, blinding methods, dropouts, and follow-up periods. [15-18] the qualitative Table 01 summarizes the key characteristics of the included studies. Saini and Mandal (2017) conducted a study with cases and controls, showing varying degrees of Improvement. Complete remission rates were 32.35% and 25.0% with topical and powder ingestion, respectively. Geethani et al. (2017) found that applying the oil alone on a lesion effectively reduced symptoms. Preethi et al. (2020) reported promising results in powder and oil interventions, with substantial percentages of patients experiencing complete or marked Improvement. Balyaya and D'Souza (2020) found that topical oil was an equally practical application [15-18]. The quantitative table provided further insights into the sample sizes, clinical presentations, mean age, interventions, and improvements observed in the studies. Saini and Mandal (2017) reported complete remission rates of 32.35%. Geethani et al. (2017), Preethi et al. (2020) and Balyaya and D'Souza (2020) observed reductions in symptoms with the application of oil [15-18]. The reviewed studies shed light on the potential benefits of topical oil application for *Tenia* infection. However, it is essential to note the limitations of the studies, including the absence of placebo or non-treatment control groups, variations in sample sizes and intervention durations, and heterogeneity in outcome assessment methods.

## DISCUSSION

The systematic review focused on evaluating the effectiveness of Cassia Tora plant oil interventions for *Tenia* infection in the skin. The review's main findings indicate that topical oil formation shows promise in managing symptoms such as itching, circular patches, pain, redness, dryness, and eruptions. However, it is essential to note that the reviewed studies had limitations to be considered when interpreting the findings. One of the strengths of the reviewed studies is their focus on evaluating the effectiveness of Cassia Tora plant interventions specifically for such skin lesions. The plant seeds contain three major phytochemicals-Emodin, physcion and rhein [19]. Cassia tora L. is a known antifungal plant because of an anthraquinone, chrysophanol, which inhibits cell wall synthesis, leads to delayed fungus sporulation, and reduces spore germination [20]. Several antifungal agents in MSM have been introduced into clinical practice in recent years, including griseofulvin, terbinafine, Itraconazole, and fluconazole [21]. However, their spectrum of action is narrow, and many have specific adverse effects, such as gastrointestinal disturbances, nephrotoxicity, hepatotoxicity and leucopenia [22]. Treating dermatophytes infection is mostly long and very expensive, and there have been multiple reports of drug resistance [23]. Increased incidence of such dermatological infections due to the rise in immune compromised population, coupled with the resistance to antifungal and toxicity during prolonged treatment, has been the reason for an extended search for newer therapeutic approaches to treat opportunistic infections. Thus, it is imperative to develop such a treatment for broad-





**Anuradha Indrajit Khandekar et al.,**

spectrum dermatophytes infection with fewer adverse effects [24]. The phenolic compounds act as an antimicrobial agent by inactivating microbial adhesion, enzymes and other proteins through non-specific forces like hydrogen bonding, covalent bonding, hydrophobic interactions and inhibiting cell wall polymer synthesis [25]. To our knowledge, no previous systematic review specifically focused on this topic has been published. However, the findings of this review are consistent with the general literature that recognizes the potential of Cassia Tora plant extracts in treating various skin diseases.

## CONCLUSION

*Chakramard* (Cassia Tora) plant interventions are effective in managing *Dadru Kushta* (Tenia infection) is partially confirmed by the findings of the reviewed studies. The positive outcomes observed in terms of symptom relief support the hypothesis. However, the limitations in the study design and lack of control groups prevent a definitive confirmation of the hypothesis. Further research with well-designed comparative trials and rigorous safety assessments is needed to provide more substantial evidence.

## REFERENCES

1. VaidyaYadavjiTrikamji Acharya. AgniveshaCharaka Samhita with Ayurveda Dipika Commentary. Varanasi: ChaukambhaOrientalia; 2007. p. 451.
2. Sharma P V. (ed). Susrutha Samhita. Varanasi: ChaukhambaSanskritaSamsthana; 2003. vol2, p. 37-38.
3. VaidyaYadavjiTrikamji Acharya. AgniveshaCharaka Samhita with Ayurveda Dipika Commentary. Varanasi: ChaukambhaOrientalia; 2011. ChikitsaSthana, Chapter-7, p.451
4. Burns, Breathnach, Cox, Griffiths. Rook's textbook of dermatology. 7th ed. Blackwell publishers; 2004. Vol 2, chapter-31.19.
5. Pecci M, Comeau D, Chawla V. Skin conditions in the athlete Am J Sports Med. Bhalani Publishing House; 2009. p 406-18.
6. Vaidya JadavjiTrikamji Acharya. Agnivesha, Charaka Samhita. Varanasi: ChaukhambhaPrakashan. 2011, Sutrasthana, Chapter 11, p.78.
7. Samarawickrama AG, Kumari C. EvidenceBased Clinical Ayurvedic Management of Dadrukushta (Dermatophytosis) by Chakramarda Taila. IJAPR. 2017;5(8):49-53.
8. Pt. Lal Chand Vaidya. Bhav Prakash, MadhyamKhand. Publisher MotilalBanarasi Das; Delhi: 1958.
9. Kaviraj Shri AmbikaDuttShastri. BhaishajyaRatnawali, Vidyotini Hindi Tika. Varanasi: Chaukhambha Sanskrit Sansthan; 1983.
10. Dr. BrahmanandTripathi. Charak Samhita, Charak Chandrika Tika. II ed. ChaukhambhaSurbhartiPrakashana; 1991.
11. Pt. Shastri K.N., Chaturvedi G.N. Charak Samhita, Vidyotini Hindi Commentary. Publication Chaukhambha Bharti Academy; Varanasi.
12. Ghannoum, JA, Elewski BE. Skin care (analysis) and Health Care. 1st ed. Am J Sports Med 2009; 37: p. 406-18.
13. Kaplan W. Epidemiology and public health significance of ringworm in humanity. 4 ed. AcadDermatol; 1967 Oct. 96. p 204-206.
14. Agnivesha, CharakaSamhita with Ayurveda Dipika Commentary, edited by Vaidya YadavjiTrikamji Acharya, ChaukambhaOrientalia, Varanasi-2007, p. 451.
15. Jeeta Ram Saini, Sisir Kumar Mandal. Role of CakramardaBija (Cassia Tora Linn) on Dadru Kushta: A Randomized Controlled Group Trial. International Journal of Ayurveda and Pharma Research. 2017; 5(6):34-39
16. Samarawickrama AG, Dr A, Kumari C. Evidence Based Clinical Ayurvedic Management of Dadrukushta (Dermatophytosis) by Chakramarda Taila. Int J Ayurveda Pharma Res. 2017;5(8):11-15. Available from: <https://ijapr.in/index.php/ijapr/article/view/747>.





Anuradha Indrajit Khandekar *et al.*,

17. Preethi HM, Sharadha MK, Chowta J. A randomised controlled clinical study to evaluate the efficacy of the Mulakadimalahara in the treatment of Dadru in Children. PIJAR. 2020 Nov-Dec;5(6):1-13.
18. Balyaya K, D'Souza Z. A Randomised Controlled Clinical Trial To Study The Efficacy Of An Ethnomedicinal Formulation In Dadru Kushta. Int Ayurvedic Med J. September 2021. doi:10.46607/iamj1009092021.
19. Kumar MK, Deep KC, Kumar SA, Panik R, Kashyap P, Prasad Mishra S, et al. Medicinal Plants Having Antifungal Properties [Internet]. Medicinal Plants - Use in Prevention and Treatment of Diseases. IntechOpen; 2020. Available from: <http://dx.doi.org/10.5772/intechopen.90674>
20. Prateeksha, Yusuf MA, Singh BN, Sudheer S, Kharwar RN, Siddiqui S, et al. Chrysophanol: a natural anthraquinone with multifaceted biotherapeutic potential. Biomolecules. 2019 Feb 18;9(2):68.
21. Pires CA, Cruz NF, Lobato AM, Sousa PO, Carneiro FR, Mendes AM. Clinical, epidemiological, and therapeutic profile of dermatophytosis. Anais brasileiros de dermatologia. 2014 Mar;89:259-64.
22. Cornejo-Garrido J, Salinas-Sandoval M, Díaz-López A, Jáquez-Ríos P, Arriaga-Alba M, Ordaz-Pichardo C. In vitro and in vivo antifungal activity, liver profile test, and mutagenic activity of five plants used in traditional Mexican medicine. Revista Brasileira de Farmacognosia. 2015 Jan;25:22-8.
23. Njateng GS, Gatsing D, Mouokeu RS, Lunga PK, Kuate JR. In vitro and in vivo antidermatophytic activity of the dichloromethane-methanol (1: 1 v/v) extract from the stem bark of PolysciasfulvaHiern (Araliaceae). BMC Complementary and Alternative Medicine. 2013 Dec;13(1):1.
24. Cornejo-Garrido J, Salinas-Sandoval M, Díaz-López A, Jáquez-Ríos P, Arriaga-Alba M, Ordaz-Pichardo C. In vitro and in vivo antifungal activity, liver profile test, and mutagenic activity of five plants used in traditional Mexican medicine. Revista Brasileira de Farmacognosia. 2015 Jan;25:22-8.
25. Lopes G, Pinto E, Salgueiro L. Natural products: an alternative to conventional therapy for dermatophytosis. Mycopathologia. 2017 Feb;182:143-67.

**Table 1: Qualitative characteristics of the four studies**

Sr. No.	Author (Year)	Sampling design	Sample size calculation	Blinding	Dropouts	Follow up
1.	Saini and Mandal (2017)	Simple random	Not mentioned	Not done	6 cases	45 days
2.	Geethani et al. (2017)	Convenience sampling method	Not mentioned	Not done	4 cases	15 days
3.	Preethi et al. (2020)	Lottery method	Not mentioned	Not done	Not mentioned	28 days after treatment
4.	Balyaya and D'Souza (2020)	Lottery method	Not mentioned	Single blind	Not mentioned	21 days

**Table 2: Quantitative table**

Sr.no.	Author year	Sample size in case and controls	Mean age	Intervention (cases)	Intervention (Controls)	Improvement (cases)	Improvement (controls)
1.	Saini and	40	43	Six weeks	Six weeks	Complete	Complete





**Anuradha Indrajit Khandekar et al.,**

	Mandal (2017)			(Other plant extract)	(Powdered form of Cassia Tora)	remission in 32.35%. Moderate in 41.17%. Mild in 23.52%.	remission in 25.0%. Moderate remission in 44.44%. Mild remission in 25.0%.
2	Geethani et al. (2017)	34 cases and no control	42	15 days (topical oil application)	None	Symptoms by the eighth day	-
3.	Preethi et al. (2020)	30	12	21 (Cassia Tora oil application)	21(not clear)	Mild Improvement =5 (17%) Moderate Improvement =7 (23%) Complete Improvement =18 (60%)	Mild Improvement =6 (20%) Moderate Improvement =10 (33%) Complete Improvement =14 (47%)
4.	Balyaya and D'Souza (2020)	20	38	14(Cassia Tora oil application)	14(other natural plant oil extract)	Mild Improvement =8 Moderate Improvement =8 Complete improvement =4	Mild Improvement =4 Moderate Improvement =10 Complete improvement =6





## Phytoplankton Productivity under Climate-Driven Fluctuations: An Assessment

Aparna Rathore\*

Assistant Professor, Department of Botany, Kanoria PG Mahila Mahavidyalaya, (Affiliated to University of Rajasthan), Jaipur, Rajasthan, India.

Received: 23 Jan 2024

Revised: 09 Feb 2024

Accepted: 26 Apr 2024

### \*Address for Correspondence

**Aparna Rathore**

Assistant Professor,

Department of Botany,

Kanoria PG Mahila Mahavidyalaya,

(Affiliated to University of Rajasthan),

Jaipur, Rajasthan, India.

Email: aparna1515@gmail.com



This is an Open Access Journal / article distributed under the terms of the **Creative Commons Attribution License** (CC BY-NC-ND 3.0) which permits unrestricted use, distribution, and reproduction in any medium, provided the original work is properly cited. All rights reserved.

### ABSTRACT

Primary productivity can be defined as the amount of organic material produced per unit area per unit time. Phytoplankton in the ocean contribute about half of the planet's net primary production. Both temperature and irradiance are important factors in determining phytoplankton productivity. Climate change is accompanied by increasing solar radiation, which increases warming, and leads to an increase in sea surface temperature, which limits nutrients necessary for primary production. Through comprehensive assessments, we can elucidate the intricate relationships between climate variables and phytoplankton productivity, considering the implications for aquatic ecosystems. The aim of the present study is to understand the variability of phytoplankton productivity of an oligotrophic pond due to the climatic fluctuations under different temperature and light conditions. This research focuses on determining the effects of extreme light and temperature conditions on phytoplankton productivity and their impact on the environment. It also aims to enhance our understanding of the complex interactions shaping phytoplankton dynamics under changing climate scenarios, providing valuable insights for both ecological research and sustainable resource management in aquatic environments.

**Keywords:** Phytoplankton productivity, climate change, climatic variation.

### INTRODUCTION

Phytoplankton are the primary producers of the aquatic food web (Vargas et al, 2006). The main types of phytoplankton are cyanobacteria, diatoms, dinoflagellates, green algae, mangroves, seagrasses, macroalgae and salt



**Aparna Rathore**

marshes (Duarte et al, 2005). They capture solar energy to produce energy in a food chain by photosynthesis. The rate of this energy accumulation is called primary productivity. Primary productivity may be defined as the amount of organic material produced per unit area per unit time (Cloern et al., 2014). All phytoplankton contain photosynthetic pigment chlorophyll-a; and other accessory pigments like chlorophyll-b, chlorophyll-c, and carotenoids (Barlow et al, 2013). These pigments help in photosynthetic process that produces gross primary production; and the difference between gross primary production and respiration gives net primary production (Kyewalyanga, 2016). According to Field et al., 1998, although marine phytoplankton constitute less than 1 percent of the earth's photosynthetic biomass, they are responsible for almost half the global annual net primary production. Phytoplankton are the major biomass producers in aquatic ecosystems and play significant role in regulating global climate. Several abiotic factors such as light, temperature, CO<sub>2</sub> concentration, acidification and ultraviolet radiation have been found to exert pronounced effects on their productivity (Richa et al 2014). Phytoplankton photosynthesis is limited by the availability of nutrients and light, leading to suppressed growth and productivity in oligotrophic or light limited environments (Fox et al, 2020). According to Mitsch and Gosselink, 1993, the producers utilize only some part of the energy and so complete energy is not available for the food web.

The food chain and food web can be understood best by the estimation of primary productivity (Chinnaiah et al., 2010), physico-chemical characteristics of water (Wetzel, 2000) and level of pollution (Prabhakar et al., 2009). The anthropogenic activity is major cause for affecting primary productivity of the aquatic ecosystem. Climate change is associated with increased irradiance, causing warming, which raises sea-surface temperature. A large scale study of primary production through remote sensing has shown that increase in sea surface temperature triggered a reduction in the global production of ocean phytoplankton since the early 1980s (Behrenfeld et al, 2006). Over the last 40 years, the global oceans have warmed at a rate of ~0.1 °C per decade. Hence, phytoplankton phenology is altered under such warmer climate scenarios (Gittings et al 2018). Owing to ocean acidification decrease in calcification causes a higher exposure of the organisms to solar UV radiation (Hader et al., 2015). Solar UV-B irradiation (280 - 315 nm) decreases photosynthetic carbon fixation (Gao et al., 2007a, Hader et al., 2011), causes DNA (Buma et al., 2006, Gao et al., 2008) and protein damage (Bouchard et al., 2006) and alters the morphology (Wu et al., 2009) of photosynthetic organisms. (Richa et al 2014).

This project focuses on determining the effect of the changing light and temperature conditions on phytoplankton productivity in the oligotrophic habitat and how it would implicate the environment in correlation to the changing climate. It focuses on the effect of varying light and temperature conditions on the gross and net phytoplankton productivity which can be correlated with the present day climate change conditions which are affecting the phytoplanktons and their productivity.

**MATERIALS AND METHODS**

The research was conducted in the water lily pond located in the premises of Kanoria PG MahilaMahavidyalaya, Jaipur. The primary productivity was determined by using standard "light and dark bottle" method (Gardner & Gran, 1927). The dissolved oxygen (DO) is estimated by light and dark bottle method of Winkler (Wetzel and Linkens, 2000). The incubation period in the present study was for the period of 2 hours. The observed Gross Primary Productivity (GPP), Net Primary Productivity (NPP) and Community Respiration (CR) in mg/l/hr were converted into gC/m<sup>3</sup>/hr by multiplying these values with a factor of 0.375. The Gross Primary Productivity (GPP), Net Primary Productivity (NPP) and Community Respiration (CR) were estimated by using formulae of Westlake (1963). Net Production Efficiency (NPE) and Respiration (% of GPP) were calculated by using formulae of Chattopadhyay and Banerjee (2008) with the help of GPP, NPP and CR. Water samples were collected in BOD bottles from the pond and the samples were separated for treatment with light, dark, UV light, and high temperature (50°C) for a standard period of 2 hours. Volumetric analysis of all the samples was done as per the method of Gardner and Gran, 1927.





Apama Rathore

## RESULT AND DISCUSSION

Phytoplankton productivity, primarily is influenced by several factors like carbon dioxide, sunlight and nutrients for growth, but some other factors such as water depth, water temperature, wind and grazers also play a significant role (Kyewalyanga, 2016). In the present study primary productivity of the lily pond has been determined. The Primary productivity recorded as Gross primary productivity, Net primary productivity, Community respiration, Net production efficiency and respiration (% of GPP) are discussed as follows.

### Gross Primary Productivity (gC/m<sup>3</sup>/hr)

Gross primary productivity of the sample exposed to high temperature and UV light was lower ( $-0.038 \pm 0.02$ ) than the normal sample ( $0.114 \pm 0.07$ ) as shown in figure 1. Gross primary productivity is considered to be total photosynthetic activity or total assimilation of the any ecosystem. The higher values of GPP during the exposure to sunlight leads to the high biomass of phytoplankton, the results are in context of work done by Mitsch and Gosselink (1993); Anjinappa (2002); Das (2002) and Radwan (2005); Garcia-Corral, 2017

### Net Primary Productivity (gC/m<sup>3</sup>/hr)

Net primary productivity of the sample exposed to high temperature and UV light was lower ( $-0.190 \pm 0.03$ ) than the normal sample ( $-0.038 \pm 0.02$ ) as shown in figure 2. Net primary productivity is measurement of the rate of storage of organic material in the tissues of primary producers of the ecosystem after utilization of respiratory activity of the primary producers. Phytoplankton growth, and NPP, is a function of light, temperature and nutrients (Geider et al., 1998; Fox et al 2020).

### Community Respiration (gC/m<sup>3</sup> /hr)

The community respiration was reported as  $0.152 \pm 0.12$ . Community respiration is defined as reduction of NPP from GPP and later converted into releasing of CO<sub>2</sub>. The high community respiration of all biotic and abiotic components organic matter reduces the content of dissolved oxygen. Similar results showing high rate of community respiration have been reported by Prabhakaret al. 2009; Garcia-Corral, 2017.

### Net Production Efficiency (%)

Net production efficiency is the determination of ratio of the efficiency with which an organism converts assimilated energy into GPP or NPP production. Net production efficiency of the sample exposed to high temperature and UV light was lower ( $33.39 \pm 0.63$ ) than the normal sample ( $50.48 \pm 0.41$ ) respectively. Similar results were also observed by Chattopadhyay and Banerjee (2008); Chinnaiah and Madhu, 2010; Hader et al, 2015 and Garcia-Corral, 2017.

### Respiration (% of GPP)

The respiration % of the sample exposed to high temperature and UV light was higher ( $4.01 \pm 1.02$ ) than the normal sample ( $1.33 \pm 0.79$ ) respectively. Similar result was obtained by Chinnaiah and Madhu (2010). At higher temperatures an optimum is reached after which photosynthesis declines again, while respiration usually increases with rising temperatures (Zou et al., 2011). Irradiance is a major driving force for photosynthesis; it warms the surface waters, thereby regulating the water temperature. Both temperature and irradiance vary with the seasons of the year (Bouman et al, 2005). Light is the single most important factor for photosynthesis in primary producers both in terrestrial and aquatic habitats (Richa et al 2014). In tropical marine ecosystems, warmer conditions may reduce the abundance and primary productivity of phytoplankton (Gittings et al, 2018). Studies on primary productivity of many aquatic ecosystems have been reported earlier by Chinnaiah et al., 2010; Joseph and Shanthi, 2010; Patil and Chavan 2010; and Vasanthkumar and Kumar, 2011. Solar UV-B radiation affects a wide spectrum of cellular targets in phytoplankton. In addition to damage to elements of the photosynthetic machinery, such as the D1 protein in the electron transport chain in PSII (Bouchard et al., 2006), energetic short-wavelength UV radiation damages DNA, either directly by the induction of cyclobutane dimers (Klisch et al., 2005) or by the formation of detrimental ROS



**Aparna Rathore**

(Reactive Oxygen Species) (Ferreira et al., 2006, Pelletier et al., 2006). (Richa et al, 2014). This is in correlation to many researches done by Behrenfeld et al, 2006; Indur et al 2016; Garcia-Corral, 2017 and Kafriksen et al 2022.

**CONCLUSION**

The study focused on assessing the dynamics of phytoplankton productivity under induced climate-driven fluctuations. Through comprehensive analysis and experimentation, it became evident that climate-driven fluctuations significantly influence phytoplankton productivity, leading to dynamic shifts in aquatic ecosystems. The findings underscore the intricate relationship between climate variables and phytoplankton, emphasizing the need for a better understanding of these dynamics to anticipate and mitigate potential ecological consequences. The results of above study indicate that, the phytoplankton productivity declined owing to exposure to UV radiation and high temperature conditions. The study probably conclude that the gross and net phytoplankton productivity vary according to the light and temperature treatments given to them. It would in turn help us in predicting the effects of changing climate on phytoplankton productivity in terms of light intensity and temperature variation. The probable outcome of the research work will help in estimating the variability in the phytoplankton productivity as per the changes in climatic regimes and will also help us to know the importance of phytoplanktons as good carbon sequesters as far as climate change is concerned. Moreover, the research emphasizes the urgency of addressing climate change to mitigate its impacts on phytoplankton productivity and the ecosystems they support. Implementing sustainable practices and policies that reduce greenhouse gas emissions and promote ecosystem resilience will be crucial in safeguarding aquatic environments and maintaining the balance of marine ecosystems.

**REFERENCES**

1. Anjinappa H, Hydrobiological Studies and Avi-Fauna at Bonal Reservoir, Shorapur, Gulbarga District. PhD Thesis, Gulbarga University, Gulberga, 2002, 156.
2. Barlow, R., Lamont, T., Britz, K. and Sessions, H. (2013). Mechanisms of phytoplankton adaptation to environmental variability in a shelf ecosystem. *Estuar. Coast. Shelf S.* 133, 45-57
3. Behrenfeld, M. J., O'Malley, R. T., Siegel, D. A., McClain, C. R., Sarmiento, J. L., Feldman, G. C., Milligan, A. J., Falkowski, P. G., Letelier, R. M., Boss, E. S., (2006). Climate-driven trends in contemporary ocean productivity. *Nature* 444, -755.
4. Bouchard, J. N., Roy, S., Campbell, D. A., (2006). UVB effects on the photosystem II-D1 protein of phytoplankton and natural phytoplankton communities. *Photochemistry and Photobiology* 82, 936-951.
5. Bouman, H., Platt, T., Sathyendranath, S., and Stuart, V. (2005). Dependence of light-saturated photosynthesis on temperature and community structure. *Deep Sea Research Part I Oceanographic Research Paper* 52(7), 1284-1299
6. Buma, A. G. J., Wright, S. W., Van Den Enden, R., Van De Poll, W. H., Davidson, A. T., (2006). PAR acclimation and UVBR-induced DNA damage in Antarctic marine microalgae. *Marine Ecology Progress Series* 315, 33-42.
7. Chattopadhyay C, Banerjee TC. Water Temperature and Primary Production in the Euphotic Zone of a Tropical Shallow Freshwater Lake. *Asian Journal of Experimental Sciences* 2008; 22(1):103-108.
8. Chinnaiah B, Madhu V. Primary Productivity of Darnasagar Lake in Adilabad, Andhra Pradesh, India. *International Journal of Pharmacy and Life Sciences* 2010; 1(8):437-439.
9. Cloern, J.E., Foster, S.Q. and Kleckner, A.E. (2014). Phytoplankton primary production in the world's estuarine coastal ecosystem. *Biogeosciences* 11, 2477-2501
10. Das AK. Phytoplankton Primary Production in some selected reservoirs of Andhra Pradesh *Geobios* 2002; 29:52-57.
11. Duarte, C.M., Middelburg, J.J. and Caraco, N. (2005). Major role of marine vegetation on the oceanic carbon cycle. *Biogeosciences* 2, 1-8





### Aparna Rathore

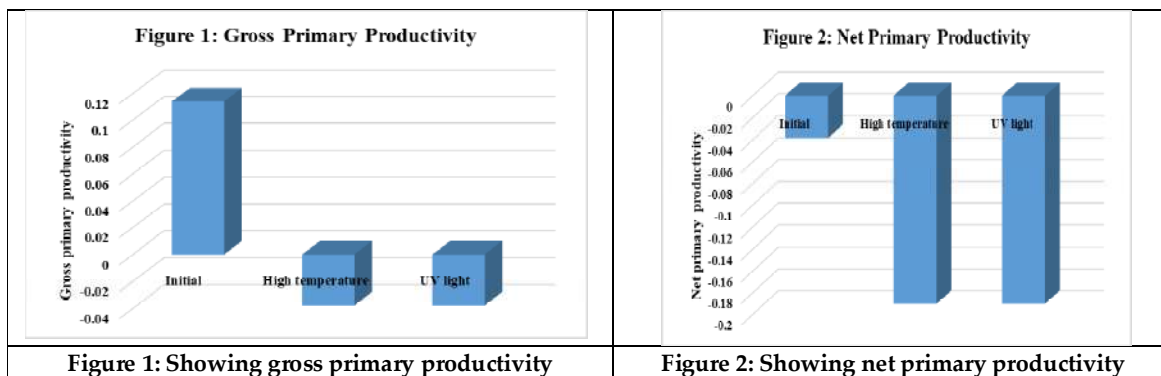
12. Ferreyra, G. A., Mostajir, B., Schloss, I. R., Chatila, K., Ferrario, M. E., Sargian, P., Roy, S., Prod'homme, J., Demers, S., (2006). Ultraviolet-B radiation effects on the structure and function of lower trophic levels of the marine planktonic food web. *Photochemistry and Photobiology* 82, 887-897.
13. Field, C. B., Behrenfeld, M. J., Randerson, J. T., and Falkowski, P. G. (1998). Primary production of the biosphere: integrating terrestrial and oceanic components. *Science* 281, 237–240. doi: 10.1126/science.281.5374.237
14. Fox, J., Behrenfeld, M.J., Haëntjens, N., Chase, A., Kramer, S.J., Boss, E., Karp-Boss, L., Fisher, N.L., Penta, W.B., Westberry, T.K., Halsey, K.H., *Phytoplankton Growth and Productivity in the Western North Atlantic: Observations of Regional Variability From the NAAMES Field Campaigns, 2020*, *Frontiers in Marine Science* 7 pp: 1-15 <https://doi.org/10.3389/fmars.2020.00024>
15. Gao, K., Helbling, E. W., Häder, D.-P., Hutchins, D. A., (2012). Responses of marine primary producers to interactions between ocean acidification, solar radiation, and warming. *Marine Ecology Progress Series* 470, –189
16. Gardner T, Gran HH. Investigation of the production of plankton in the Oslo Fiord. *Rapp. Et Proc-Verb. Cons Internat Explore Scient Mer Mediterr* 1927; 42:1-48
17. Geider, R. J., MacIntyre, H. L., and Kana, T. M. (1998). A dynamic regulatory model of phytoplankton acclimation to light, nutrients, and temperature. *Limnology and Oceanography* 43, 679–694. doi: 10.4319/lo.1998.43.4.0679
18. Gittings J.A., Raitsos, D.E., Krokos, G., Hoteit, I., 2018, Impacts of warming on phytoplankton abundance and phenology in a typical tropical marine ecosystem, *Scientific reports*, 8:2240 DOI:10.1038/s41598-018-20560-5 pp: 1-12
19. Hader, D.-P., Williamson, C.E., Wängberg, S.-A., Rautio, M., Rose, K.C., Gao, K., Helbling, E.W., Sinha, R.P., and Worrest, R. (2015). Effects of UV radiation on aquatic ecosystems and interactions with other environmental factors. *Photochemical & Photobiological Sciences*. 14; 108-126.
20. Indur B., Reddy R., 2, Vijaykumar K., 2016, Seasonal Variation in Primary Productivity of Freshwater Reservoirs of Yadgir District, Karnataka, India *International Journal of Environment, Agriculture and Biotechnology (IJEAB)* Vol-1, Issue-2 , pp- 102-105
21. Joseph K, Shanthi K. Assessment of the Primary Productivity of Muvattupuzha River, Kottayam, Kerala. *Journal of Ecotoxicology and Environmental Monitoring* 2010; 20(4):355- 355.
22. Kafri S, Giesbrecht, K E., McNabb, B J., Long J E., Martin C., Wyatt S N., Lagunas M G., Varela D E., 2022. An 8-year record of phytoplankton productivity and nutrient distributions from surface waters of Saanich Inlet, *Scientific Data*, *Nature*, 9: 377
23. Klisch, M., Sinha, R. P., Helbling, E. W., Häder, D.-P., (2005). Induction of thymine dimers by solar radiation in natural freshwater phytoplankton assemblages in Patagonia, Argentina. *Aquatic Sciences* 67, 72-78.
24. Kyewalyanga, M. 2016 Chapter 16 Phytoplankton Primary Production, *Regional State of the Coast Report, IV. Assessment of major ecosystem services from the marine environment*, Final RESOCR report pp: 207-225
25. Mitsch WJ, Gosselink JG. *Wetlands* Edn 2, Van Nostrand Reinhold, Newyork, USA, 1993, 722.
26. Patil A, Chavan N. 2010. Primary Productivity Studies in Some Freshwater Reservoirs of Sangali District, Maharashtra. *Nature Environment and Pollution Technology*. 9(1): 101-103
27. Pelletier, A., Sargian, P., Payet, J., Demers, S., (2006). Ecotoxicological effects of combined UVB and organic contaminants in coastal waters: a review. *Photochemistry and Photobiology* 82, 981-993.
28. Prabhakar VM, Vaidya SP, Garud VS, Swain KK. Trend in Primary Production in Khadakwasla Reservoir. 13th World Lake Conference, Wuhan, China, 2009.
29. Radwan AM. Some Factors Affecting the Primary Production of Phytoplankton in Lake, Burulus. *Egyptian Journal of Aquatic Research* 2005; 31(2):72 88.
30. Richa, Sinha, R.P., and Hader, D-P. (2014), Phytoplankton productivity in a changing global climate. Pp: 1-35 *Nature* 367, 260-263.
31. Sigman D.M. and Hain, M.P., 2012. The Biological Productivity of the Ocean, *Nature Education* 3 (6): 1-16
32. Vargas. C.A., Escribano, R. and Poulet, S. (2006). Phytoplankton food quality determines time windows for successful zooplankton reproductive pulses. *Ecology* 8, 2992-2999





**Apama Rathore**

33. Vasanthkumar B, Kumar KV. Diurnal Variation of Physicochemical Properties and Primary Productivity of Phytoplankton in Bheema River, Gulberga. *Recent Research in Science and Technology* 2011; 3(4):39-42.
34. Viet, N.D., AnhBac, N., Huong, H.T.T. 2016, Dissolved Oxygen as an Indicator for Eutrophication in Freshwater Lakes, *Proceedings of International Conference on Environmental Engineering and Management for Sustainable Development* pp: 1-6
35. Westlake DF. Comparison of Plant Productivity. *Botanical Research* 1963; 25: 385-425.
36. Wetzel RD, Linkens GE. *Limnological Analysis*. Edn 3, Springer, Newyork Xv, 2000, 429.
37. Wu, H., Gao, K., Wu, H., (2009). Responses of a marine red tide alga *Skeletonemacostatum* (Bacillariophyceae) to long-term UV radiation exposures. *Journal of Photochemistry and Photobiology*. 94, 82-86.
38. Zou, D., Gao, K., H., L., (2011). Short- and long-term effects of elevated CO<sub>2</sub> on photosynthesis and respiration in the marine macroalga *Hizikiafusiformis* (Sargassaceae, Phaeophyta) grown at low and high N supplies. *Journal of Phycology* 47, 87-97.
39. Rajesh, M., Rehana, S. Impact of climate change on river water temperature and dissolved oxygen: Indian riverine thermal regimes. *Scientific Reports* 12, 9222 (2022). <https://doi.org/10.1038/s41598-022-12996-7>
40. Febiyanto, F. 2020 Effects of Temperature and Aeration on The Dissolved Oxygen (DO) Values in Freshwater Using Simple Water Bath Reactor: A Brief Report. *Walisongo Journal of Chemistry* 3 (1) (2020), 25-30 DOI: <https://doi.org/10.21580/wjc.v3i1.6108>
41. Garcia-Corral, L. S., Holding, J. M., Carrillo-de-Albornoz, P., Steckbauer, A., Pérez-Lorenzo, M., Navarro, N., Serret, P., Gasol, J. M., Morán, X. A. G., Estrada, M., Fraile-Nuez, E., Benítez-Barrios, V., Agusti, S., and Duarte, C. M.: Temperature dependence of plankton community metabolism in the subtropical and tropical oceans, *Global Biogeochemical Cycle*, 31, 1141-1154, <https://doi.org/10.1002/2017GB005629>, 2017.







## Effect of Anterior Basal Lift versus Vertebral Pressure Technique on Pulmonary and Hemodynamic Parameters in Mechanically Ventilated Patients –An Interventional Study

Dinkey A. Mankad<sup>1</sup>, Tejas R. Chokshi<sup>2\*</sup> and Nandni K. Lal<sup>1</sup>

<sup>1</sup>MPT scholar [Cardio Respiratory & Intensive Care], Department of Physiotherapy, Krishna School of Physiotherapy & Rehabilitation, Drs Kiran & Pallavi Patel Global University, Gujarat, India.

<sup>2</sup>Associate Professor, College of Physiotherapy, Sumandeep Vidyapeeth (Deemed to be University) Piparia, Waghodia, Vadodara and Former Assistant Professor in Krishna School of Physiotherapy & Rehabilitation Drs Kiran & Pallavi Patel Global University, Gujarat, India.

Received: 30 Jan 2024

Revised: 09 Mar 2024

Accepted: 26 Apr 2024

### \*Address for Correspondence

**Tejas R. Chokshi**

Associate Professor,

College of Physiotherapy,

Sumandeep Vidyapeeth (Deemed to be University)

Piparia, Waghodia, Vadodara, Gujarat, India.

Former Assistant Professor

Krishna School of Physiotherapy

Drs Kiran & Pallavi Patel Global University,

Varnama, Vadodara, Gujarat, India.

Email: tejaspr89@gmail.com



This is an Open Access Journal / article distributed under the terms of the **Creative Commons Attribution License** (CC BY-NC-ND 3.0) which permits unrestricted use, distribution, and reproduction in any medium, provided the original work is properly cited. All rights reserved.

### ABSTRACT

Mechanical ventilation is a useful modality for patients who are unable to sustain the level of ventilation necessary to maintain the gas exchange functions. Physiotherapy is a key factor in mechanically ventilated patients. Vertebral Pressure and Anterior Basal Lift are the techniques of proprioceptive neuromuscular facilitation that produce reflex-respiratory movements. To compare the effect of Vertebral Pressure and Anterior Basal Lift technique on Pulmonary [Tidal Volume, Respiratory Rate, Minute Ventilation, Lung Compliance, and SpO<sub>2</sub>] and hemodynamic [Heart Rate and Blood Pressure] in mechanically ventilated patients. 30 participants were included in the study and divided in group A [Anterior Basal Lift] and group B [Vertebral Pressure]. Patients were given intervention for 3 days and pre and post outcomes were observed. Data were analyzed by SPSS- 21. t-test [paired and un-paired] were applied. Statistically significant improvements were observed in both groups but more pronounced in group A [Tidal Volume (t= 3.24) P<0.05 Respiratory Rate (t=2.16) P<0.05 Minute Ventilation (t=1.96) P<0.05 Heart Rate (t=2.06) P<0.05 Lung Compliance (t=7.38) P<0.05 SpO<sub>2</sub> (t=2.50)] compare to group B. There is a no significant difference in BP with all treatments. Anterior Basal Lift is more effective in reduction of

74260





Dinkey A. Mankad *et al.*,

Respiratory Rate and Heart Rate and improving Tidal Volume, Minute Ventilation and Lung Compliance & SpO<sub>2</sub> over Vertebral Pressure technique in mechanically ventilated patients.

**Keywords:** Anterior basal lift, Vertebral Pressure, Mechanical Ventilator, Respiratory PNF.

**KEY MESSAGE:** Respiratory PNF is feasible, safe, and effective, it can be used as an early intervention in mechanically ventilated patients.

**ETHICAL APPROVAL**– APPROVED

## INTRODUCTION

Intensive care unit [ICU] is a unit especially dedicated for the patients with life-threatening conditions, injuries or complications that specialize in the management for the same.[1] Among patients admitted to intensive care unit [ICU], 30-60 % received mechanical ventilation. Overall mortality rate in the intensive care unit [ICU] was 30.7% [1590] patients.[2,3] For patients who are unable to maintain the level of ventilation required to maintain gas exchange functions, mechanical ventilation is a helpful modality. When a patient experiences physiologic changes (such as lung parenchyma degradation), disease states (such as respiratory distress syndrome or atelectasis), an excessive ventilator workload (such as airflow obstruction), medical or surgical procedures (such as post-anesthesia recovery), or a variety of other factors (such as head trauma, drug overdose, etc.) that result in ventilator failure or oxygenation failure, mechanical ventilation may be necessary.[4,5] Patients who are on mechanical ventilation will be subjected to increased risk of developing life-threatening complications. [6] Complications associated with mechanical ventilation include barotraumas, hypotension, arrhythmia, oxygen toxicity, multiple organ failure, atelectasis, ventilator associated pneumonia, ARDS [ acute respiratory distress syndrome], pneumothorax, airway injury, Laryngeal injury, alveolar damage and diaphragm atrophy of diaphragm. [1,7] Inadequate ventilation leads to the retention of secretions. Deranged mechanical respiratory function is another complication frequently encountered. It is also possible to be presented with a 'stiff chest' exhibiting little respiratory movement. This may be a result of disease (lack of costal movement) or increased tone in the intercostal muscles may be implicated [10] Physiotherapy in critical care is aimed at maintaining bronchial hygiene, improve bed mobility, reducing dependency on ventilator, reduce potential pulmonary complications and also assist in weaning the patient off the ventilator.[8] Therefore, regular chest physiotherapy must be advocated to bring improvement in pulmonary and hemodynamic parameters.[9] Neurophysiological facilitation of respiration is the terminology used to describe externally applied proprioceptive and tactile stimuli that produce reflex respiratory movement responses and that appear to alter the rate and depth of breathing.[10] Vertebral Pressure and Anterior Basal Lift are the techniques of proprioceptive neuromuscular facilitation [PNF] that is one of the physiotherapy approaches.[10]

Application of respiratory proprioceptive neuromuscular facilitation techniques results in visible deeper inspiration, larger expansion of the ribs, increased tone in abdominal muscles, change in respiratory rate, more normal respiratory pattern and rapid return of mechanical stability.[10] It will facilitate the greater tidal volume and improve compliance and hemodynamic parameters.[11] The anterior basal lift provides maintained stretch anteriorly and pressure posteriorly. It facilitates bucket and pump handle excursion of the ribs, along with increased epigastric movement. Activation of muscle spindles may occur with this technique and also it produces reflex inspiratory activity. Stimulation of proprioceptors present in lower intercostal and spinal muscles might have reflex control of phrenic motor neurons.[10,12] Vertebral pressure is another respiratory PNF where there is increased epigastric abdominal excursion over T2-T4.[13] The chest care of unconscious persons is particularly challenging because of their inability to participate in the more traditional treatment approaches which require a large component of voluntary effort. Combination of different techniques is a part of physiotherapy technique in ICU. There is limited evidence available in patients who are mechanically ventilated with use of chest physiotherapy along with respiratory PNF. Therefore the present study has been undertaken to compare the effect of intercostal stretch and anterior basal lift technique on hemodynamic and pulmonary parameters in mechanically ventilated patients.



**Dinkey A. Mankad et al.,****SUBJECTS AND METHODS**

Study received an ethical approval from institutional ethical committee. 38 mechanically ventilated Patients were included in the study based on inclusion criteria. Inclusion criteria's were mechanically ventilated patients with endotracheal intubation or tracheostomy or Non-invasive face mask and Age between 18-45 years. Whereas exclusion criterias were patients with Rib fracture, chest trauma and thoracic vertebra fracture, Patient underwent thoracic or abdominal surgery past 3 months, patients with uncontrolled fever and infection and Malignancy. Written informed consent were taken from all the patients/relative who agreed to participate. Patients were allocated randomly in 1:1 ratio to either Group A, who receives anterior basal lift technique or Group B who receives vertebral pressure technique.<sup>9</sup> Participants in each group received training two times per day for 3 days. Conventional tailored made physiotherapy treatment were given to both group in the form of positioning, mobilization, manual hyperinflation (MH), percussion, chest vibrations, suction, cough techniques, and breathing exercise.[14,15,16] Outcome measures were taken in the form Lung Compliance [mL/cmH<sub>2</sub>O], Static Lung Compliance, Dynamic Lung Compliance, Tidal Volume [mL], Respiratory Rate [breaths/min], Heart Rate [beats/min], Blood Pressure, Minute Ventilation[lit/min] and Saturation of peripheral oxygen [SpO<sub>2</sub>] at the baseline and after 3 days of intervention and patients were continuously monitored throughout the treatment. Data were taken at the baseline and after 3 days of intervention and patients were continuously monitored throughout the treatment. Group A received anterior basal lift technique of chest PNF as follows - Anterior Basal Lift procedure is performed by placing the hands under the posterior ribs of the supine patient and lifting gently upward. The lift is then maintained while the patient continues to breath in his/her usual manner. Group B received vertebral pressure technique, therapist standing behind the patient. Firm pressure applied directly over the vertebrae of the upper and lower thoracic cage, the pressure should be applied with an open hand for comfort and must be firm enough to provide some stretch.

**RESULTS**

Descriptive statistical analysis obtained using frequency, percentage, mean, SD, median and IQR. Paired t-test was used for the comparison of Pre and post data within the group. Unpaired t-test was used for the comparison of data between group A and Group B. All the statistical analysis was performed by using IBM SPSS version 29.0.0. Table 1&2 depicts pre post mean and SD values of outcomes in group A &B. Table 3 represent comparison of post-procedure parameters [Mean & SD] of the group A and group B on Day3. Statistically significant improvements were observed in both groups but more pronounced in group A [Tidal Volume (t= 3.24)P<0.05 Respiratory Rate(t=2.16) P<0.05 Minute Ventilation(t=1.96)P<0.05HeartRate(t=2.06) P<0.05 Lung Compliance (t=7.38) P<0.05 SpO<sub>2</sub>(t=2.50)] compare to group B. There was no significant difference in BP with all treatments.

**DISCUSSION**

The present study has focused on the comparison of effect of Vertebral Pressure and Anterior basal lift techniques on respiratory rate, saturation of peripheral oxygen and heart rate, Tidal volume, Minute Ventilation, Lung Compliance and BP parameters and has found that on different parameters the neurophysiologic facilitation affects respiration of patients differently. Findings of the study supported by Rajiv Sharma who compared the proprioceptive neuromuscular facilitation vs. resistance training of respiratory muscles on respiratory rate on 30 ICU patients and found that PNF was successful in reducing respiratory rate in ICU patients when compared with abdominal weights placed on their upper abdomen. [17,18] This study supports the statement of N. B. Thakkar (2006) that there is an advantage of application of PNF stretch technique in ICU patients as it helps in lowering the raised RR and HR and in improving SPO<sub>2</sub> levels within near to range which is acceptable for ventilator weaning process.[19,20] Study also support the study of Binesh Asokan Poozhikunnath who observe the effect of respiratory PNF in COVID patients and conclude that significant improvement was noticed in terms of Respiratory Rate and Oxygen Saturation in



**Dinkey A. Mankad et al.,**

Experimental Group when compared to Control Group.[21] A study conducted by Dr. Hardini Prajapati To check the effectiveness of NPF of respiration on ventilation of mechanically ventilated patients and conclude that NPF of respiration can improve the ventilation of mechanically ventilated patients and supports this study. [22] Kumar Jithendra research statement also supports this research outcome by suggesting that the ICU-based patient's PNF method shows enhancement in patient condition through decreased respiratory rate and heart rate, increased SPO<sub>2</sub> and enables mechanical ventilation in early weaning.[23] A survey study conducted by Anup Bhat et al (2014 ) to assess the current chest physiotherapy practices in neurological ICUs of India. According to this survey, nearly 85% of physiotherapists practiced PNF techniques in neurological ICU patients.[24]Abhinav Salve et.al conducted a study on the Effect of Vertebral Pressure Technique and Intercostal Stretch Technique on Respiratory Rate, Tidal Volume, SpO<sub>2</sub> and Heart Rate among Organophosphorus Poisoning Patients: An Experimental Study and found that both the techniques have equal significant diff in mechanically ventilated patients but these study conclude that Anterior basal lift technique is more effective compare to vertebral pressure technique in mechanically ventilated patients.[25] To generate reactions to reflex respiratory movement, a facilitator stimulus in the form of proprioceptive neuromuscular facilitation (PNF respiration) is well accepted. Airways, lung, and respiratory muscle information from sensory receptors, as well as central and peripheral chemo receptors, regulate respiratory drive. GOT (glutamic oxaloacetic transaminase) is responsible for controlling the contraction and relaxation of the respiratory muscles. It is sensitive to both active and passive muscle stretch, which causes a firing discharge of the muscle spindle. This signal is then transmitted to the central nervous system (CNS) via Alpha and Gamma motor neurons, which are directly responsible for initiating muscle contraction. Respiratory PNF techniques aid in reducing Respiratory Rate and Heart Rate by inducing parasympathetic activity. Techniques like Intercostal Stretch, Anterior Basal Shift and Thoracic Thrust help in improving ventilation by improving lung expansion and thereby improving Oxygenation. While majority of the responses to respiratory PNF are mediated by via dorsal root, stretch receptor and inter segmental reflexes therefore there was mild significant differences noted while comparing the two groups.

**CONCLUSION**

The present study conclude that both respiratory PNF technique [Anterior Basal Lift & Vertebral Pressure] are effective in improving hemodynamic and pulmonary parameter in mechanically ventilated patients. Anterior Basal Lift is more effective in reduction of RR and HR and improving Tidal Volume, Minute Ventilation and Lung Compliance & Spo<sub>2</sub> over Vertebral Pressure technique in mechanically ventilated patients

**CLINICAL IMPLICATION**

Respiratory PNF is feasible, safe and can be used as an early intervention in mechanically ventilated patients.

**LIMITATION OF THE STUDY& FUTURE SCOPE**

Some limitations of the study include the small sample, and the lack of follow-up respiratory measurements to see the duration of the observed increases in VE. The long-term effects on pulmonary morbidity, prevention of infection and resolution of atelectasis were not addressed in the current study. Future research with other PNF techniques should be conducted with large sample size and long duration.

**REFERENCES**

1. Ashtankar, A. P., & Kazi, A. (2019). Comparative Effect of Proprioceptive Neuromuscular Facilitation (PNF) and Chest Physiotherapy with Chest Physiotherapy alone on SP<sub>02</sub>, Heart Rate, Respiratory Rate, & Lung Compliance in Mechanically Ventilated Patient. *J. Pharm. Sci. & Res*, 11(10), 3514-3518.



**Dinkey A. Mankad et al.,**

2. Nagata, I., Takei, T., Hatakeyama, J., Toh, M., Yamada, H., & Fujisawa, M. (2019). Clinical features and outcomes of prolonged mechanical ventilation: a single-center retrospective observational study. *JA Clinical Reports*, 5(1), 1-8.
3. Esteban, A., Anzueto, A., Frutos, F., Alia, I., Brochard, L., & Stewart, T. Characteristic and outcomes in adult patients receiving mechanical ventilation. A 28 day international study. *JAMA*. [Internet]. 2002 [citado 11 Dic 2016]; 287: 345-55.
4. Chang, D. W. Clinical application of mechanical ventilation. Cengage Learning. 2013
5. Chawla R, Dixit SB, Zirpe KG, Chaudhry D, Khilnani GC, Mehta Y, Khatib KI, Jagiasi BG, Chanchalani G, Mishra RC, Samavedam S. ISCCM guidelines for the use of non-invasive ventilation in acute respiratory failure in adult ICUs. *Indian journal of critical care medicine: peer-reviewed, official publication of Indian Society of Critical Care Medicine*. 2020 Jan;24(Suppl 1):S61.
6. Yoshiro Hayashi, Kenichiro Morisawa, Michael Klompas, Mark Jones, Hiran Bandeshe, Robert Boots, Jeffrey Lipman, David L. Paterson, (2015) Toward Improved Surveillance: The Impact of Ventilator-Associated Complications on Length of Stay and Antibiotic Use in Patients in Intensive Care Units, *Clinical Infectious Diseases*, Volume 56, Issue 4, , Pages 471–477
7. Hess, D..R (2014). Respiratory mechanics in mechanically ventilated patients. *Respiratory Care*, 59(11), 1773-1794.
8. Castro, A. A. Calil, S. R., Freitas, S. A. Oliveira, A. B.& Porto, E. F. (2013). Chest physiotherapy effectiveness to reduce hospitalization and mechanical ventilation length of stay, pulmonary infection rate and mortality in ICU patients. *Respiratory medicine*, 107(1), 68-74.
9. Clini, E & Ambrosino N. (2005). Early physiotherapy in the respiratory intensive care unit. *Respiratory medicine*, 99(9), 1096–1104. <https://doi.org/10.1016/j.rmed.2005.02.024>.
10. Pryor, J. A., & Prasad, A. S. *Physiotherapy for respiratory and cardiac problems: adults and paediatrics*. Elsevier Health Sciences. 2008
11. Chordiya, S. S., Kazi, A., Shetty, A., Gunjal, S., Lamuvel, M., & Bhoir, T. (2017). Effect of respiratory proprioceptive neuromuscular facilitation technique with chest physiotherapy in mechanically ventilated Organophosphorus poisoning patients. *International Journal of Multidisciplinary Research and Development*, 4(6), 01-06.
12. Palekar, T. (2018) Effect of Chest Proprioceptive Neuromuscular Facilitation versus Body Positioning in Mechanically ventilated patients: A cross over study. *International journal of basic and applied research* 480 – 495
13. Zwoliński, T., Wujtewicz, M., Szamotulska, J., Sinoracki, T., Wąż, P Hansdorfer-Korzon, R. & Gosselink, R. (2022). Feasibility of Chest Wall and Diaphragm Proprioceptive Neuromuscular Facilitation (PNF) Techniques in Mechanically Ventilated Patients. *International Journal of Environmental Research and Public Health*, 19(2), 960.
14. Pattanshetty, R. B. (2011). Effect Of Multimodality Chest Physiotherapy On The Rate Of Recovery And Prevention Of Complications In Patients With Mechanical Ventilation-A Prospective Study In Medical And Surgical Intensive Care Units. *Indian journal of medical sciences* 65(5)175 -185
15. Lippi, L., de Sire, A., D'Abrosca, F., Polla, B., Marotta, N., Castello, L. M., & Invernizzi, M. (2022). Efficacy of Physiotherapy Interventions on Weaning in Mechanically Ventilated Critically Ill Patients: A Systematic Review and Meta-Analysis. *Frontiers in medicine*, 9 1 – 16
16. Gupta P, Nambi GS, Gupta G et. al. Effect of intercoastal stretch technique and anterior basal lift technique on respiratory rate, saturation of peripheral oxygen and heart rate among ICU patients. *Int J Health Sci Res*. 2014;4(2):26-30.
17. Kuroiwa R, Tateishi Y, Oshima T, Inagaki T, Furukawa S, Takemura R, et al. Mechanical Insufflation-exsufflation for the Prevention of Ventilator-associated Pneumonia in Intensive Care Units: A Retrospective Cohort Study. *Indian J Crit Care Med* 2021;25(1):62–66.
18. Sharma R, Narwal R, Kumar S. Comparison of proprioceptive neuromuscular facilitation vs resistance training of respiratory muscles on respiratory rate of patients in ICU during weaning off period. *Indian Journal of Physiotherapy and Occupational Therapy- An International Journal*. 2010; 4 (4): 125–128.
19. Shobha Keswani, Sumit Kalra et.al. Role of proprioceptive neuromuscular facilitation techniques of respiration in intensive care unit patients– a review paripex - indian journal of research volume – 7 issue -4 April – 2018





**Dinkey A. Mankad et al.,**

20. Nirali B Thakkar. Role of PNF techniques in chest physiotherapy. *Physiotherapy- The Journal of Indian Association of Physiotherapist*. 2006;2: 10-14
21. Poozhikunnath BA, Raju S, Hammadi SMA. An experimental study to analyse the effect of respiratory proprioceptive neuromuscular facilitation techniques along with conventional physiotherapy in improving oxygen saturation, respiratory rate and heart rate in COVID-19 patients admitted in ICU. *Int J Health Sci Res*. 2020; 10(11):253-259.
22. HardiniPrajapati D. " Effect of Neurophysiological Facilitation [NPF] of Respiration on Ventilation of Mechanically Ventilated Patients: An Experimental Study. *International Journal of Science and Research*. 2018 Sep;7(9):629-31
23. Chang, A., Paratz, J., & Rollston, J. (2002). Ventilatory effects of neurophysiological facilitation and passive movement in patients with neurological injury. *Australian journal of physiotherapy*, 48(4), 305-310.
24. Bhat Anup, Chakravarthy Kalyana and Bhamini K. Chest physiotherapy techniques in neurological intensive care units of India; A survey. *Indian J Crit Care Med*. 2014 ;18(6): 363–368.
25. Salve A, Maghade S, Katke S et al. Effect of vertebral pressure technique and intercostal stretch technique on respiratory rate, tidal volume, SpO2 and heart rate among organophosphorus poisoning patients: an experimental study. *Int J Health Sci Res*. 2021; 11(7): 265-271. DOI.

**Table 1: Data represent Age Distribution among Group A & B**

GROUP	MEAN & SD	t- value	p-value
Group A	37.80 ±5.14	0.78	0.43
Group B	39.33±5.49	0.78	0.43

**Table 2: Demographic represent of gender wise distribution of participants in group A and**

GROUP	GROUP A	GROUP B
MALE	8	10
FEMALE	7	5
TOTAL	15	15

**Table 3: Intra Group Comparison of outcome measures in group A**

PARAMETERS	PRE Mean & SD	POST Mean & SD	t-VALUE	p-VALUE
Lung Compliance	29.82±1.85	38.81±2.22	3.01	<0.05
Tidal volume	318.07±12.60	415.33±39.62	9.22	<0.05
Minute ventilation	7.71±0.54	9.09±0.99	8.35	<0.05
Respiratory rate	25.13±0.83	23.33±0.49	6.87	<0.05
Heart rate	126.40±5.52	119.8±5.18	11.14	<0.05
Blood pressure	144.20±12.15	143.73±11.84	1.97	>0.05
SpO <sub>2</sub>	87.80±6.93	87.40±6.59	2.10	>0.05
	96.63±0.55	98.87±0.62	7.03	<0.05

**Table 4: Intra Group Comparison of outcome measures in group B**

PARAMETERS	PRE Mean & SD	POST Mean & SD	t-VALUE	p-VALUE
Lung Compliance	28.23±1.81	33.11±2.22	14.66	<0.05
Tidal volume	316.27±12.81	378.67±18.46	14.66	<0.05
Minute ventilation	7.93±0.54	8.93±0.61	15.78	<0.05
Respiratory rate	25.47±0.99	23.87±0.83	8.41	<0.05
Heart rate	124.53±6.51	121.73±6.27	2.09	<0.05



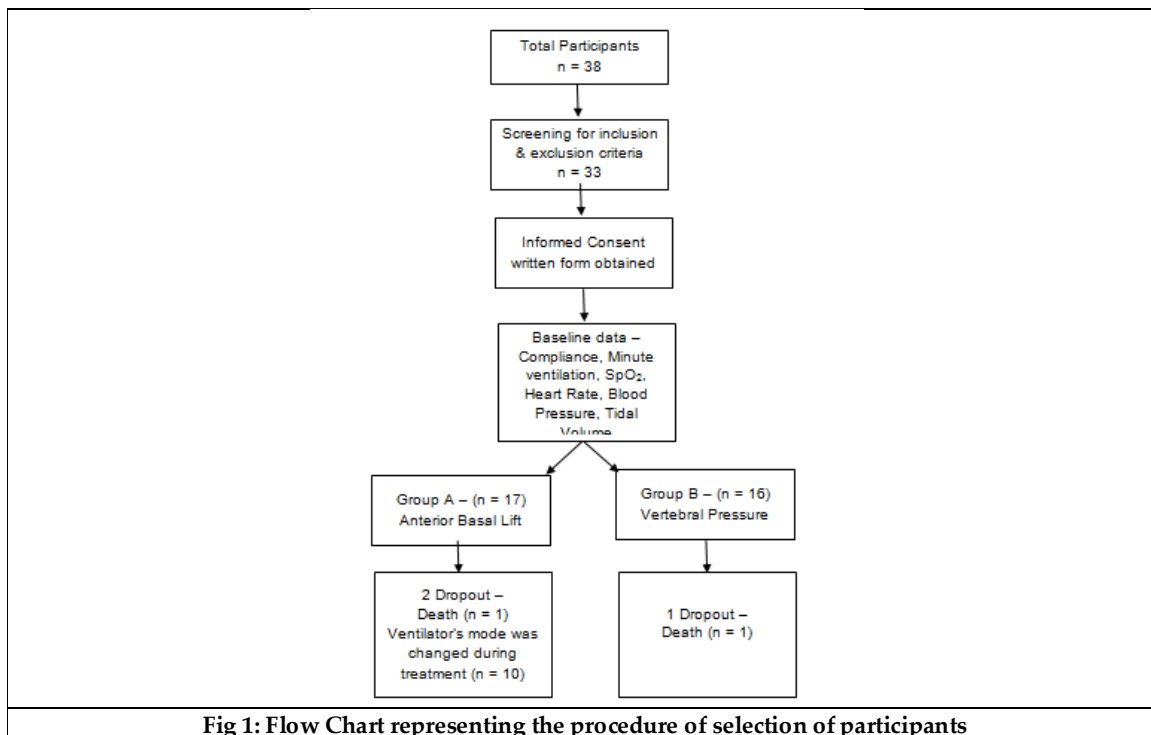


**Dinkey A. Mankad et al.,**

Blood pressure	144.20±12.15 85.87±9.07	144.56±13.16 84.93±9.37	0.18 1.58	>0.05
SpO <sub>2</sub>	97±0.83	98.23±0.77	7.03	<0.05

**Table 5: Data represent comparison of post-procedure parameters of the group A and group B on Day 3**

PARAMETERS	GROUP – A Mean & SD	GROUP-B Mean & SD	t- value	p-value
Tidal volume	415.33 ± 39.62	378.67±18.46.	3.24	0.003
Minute ventilation	9.09±0.99	8.50±0.62	1.96	0.05
Respiratory rate	23.33±0.49	23.87±0.83	2.16	0.03
Lung compliance	38.81±2.22	33.11±2.00	7.38	0.001
SpO <sub>2</sub>	98.87±0.62	98.23±0.77	2.50	0.01
Heart rate	119.8±5.18	124.54±6.93	2.06	0.04
Blood pressure	143±11.84 87.40±6.59	144.56±56 84.93±9.37	0.18 0.83	0.85 0.41





## Non-Extendable Half Companion Sequences of Special Dio 3-Tuples Involving First Type of Rectangular Numbers

Janaki G<sup>1</sup> and Gowri Shankari A<sup>2\*</sup>

<sup>1</sup>Associate Professor, Department of Mathematics, Cauvery College for Women (Autonomous), (Affiliated to Bharathidasan University) Tiruchirappalli, Tamil Nadu, India.

<sup>2</sup>Assistant Professor, Department of Mathematics, Cauvery College for Women (Autonomous), (Affiliated to Bharathidasan University) Tiruchirappalli, Tamil Nadu, India.

Received: 08 Jan 2024

Revised: 09 Apr 2024

Accepted: 29 Apr 2024

### \*Address for Correspondence

**Gowri Shankari A**

Assistant Professor,

Department of Mathematics,

Cauvery College for Women (Autonomous),

(Affiliated to Bharathidasan University)

Tiruchirappalli, Tamil Nadu, India.

Email: gowrirajinikanth@gmail.com



This is an Open Access Journal / article distributed under the terms of the **Creative Commons Attribution License** (CC BY-NC-ND 3.0) which permits unrestricted use, distribution, and reproduction in any medium, provided the original work is properly cited. All rights reserved.

### ABSTRACT

**Abstract:** This research endeavour hopes to create a non-extendable sequence of special Dio 3-tuples for the first kind of rectangular numbers, incorporating half-companion  $\{(a, b, c), (b, c, d), (c, d, e), \dots\}$  sequences with the attributes  $D(-2)$  and  $D(-11)$ , while offering some numerical displays.

**2010 Mathematics Subject Classification:** 11D99

**Keywords:** Diophantine Triples, special Dio 3-tuples, first type of Rectangular numbers, Integer sequences, Half-companion sequences.

## INTRODUCTION

A Diophantine equation is a polynomial equation containing two or more unknowns that is sought for or explored in Number theory [1–5]. The term Diophantine symbolises Diophantus of Alexandria, a Greek mathematician of the third century who probed such scenarios and was the first mathematician to incorporate emblems into variable-based mathematics. In [6, 7], a number of mathematicians probed the problem of the occurrence of Dio triples and quadruples with the criterion  $D(n)$  for any integer  $n$  and, furthermore, for any linear polynomial. In this particular scenario, one could resort to [8–11] for an exhaustive review of all of the Diophantine triple problems. Half-companion sequences of Diophantine triples were examined in [12, 13]. Non-extendable Dio 3-tuple and special Dio







**Janaki and Gowri Shankari**

3-tuple and quadruple capabilities have been explored in [14, 15]. These findings compelled us to look for non-extendable special Dio triples belonging to the first kind of rectangular numbers. The ultimate objective of this research endeavour is to generate a sequence of Special Dio 3-tuples for the first kind of rectangular numbers using non-extendable half-companion sequences  $\{(a, b, c), (b, c, d), (c, d, e), \dots\}$  in two scenarios with the attributes  $D(-2)$  and  $D(-11)$ .

**Notation:** First type of Rectangular number of rank  $n$  is  $R_n = n(n + 1)$ .

**Basic Definitions**

**Definition 1:** A set of  $m$  non-zero integers  $(a_1, a_2, a_3, \dots, a_m)$  is said to be a Dio  $m$ -tuple with the property  $D(n)$ ,  $n \in \mathbb{Z} - \{0\}$  if  $a_i * a_j + n$  is a perfect square for all  $1 \leq i < j \leq m$ .

**Definition 2:** A set of  $m$  different integers or a polynomial with integer coefficients  $(a_1, a_2, a_3, \dots, a_m)$  is said to be a special Dio  $m$ -tuple with the property  $D(n)$ ,  $n \in \mathbb{Z} - \{0\}$  or a polynomial with integer coefficient if  $a_i * a_j + (a_i + a_j) + n$  is a perfect square for all  $1 \leq i < j \leq m$ .

**Definition 3:** A set of three different integers or a polynomial with integer coefficients  $(a_1, a_2, a_3)$  is said to be a special Dio 3-tuple with property  $D(n)$ ,  $n \in \mathbb{Z} - \{0\}$  or a polynomial with integer coefficient if  $a_i * a_j + (a_i + a_j) + n$  is a perfect square for all  $1 \leq i < j \leq 3$ .

**Method of Analysis**

**Sequence: 1**

**Forming a sequence of non-extendable special Dio 3-tuples for first type of Rectangular numbers of ranks  $n-1$  and  $n+1$  with property  $D(-2)$ .**

Let  $a = R_{n-1} = (n - 1)n$  and  $b = R_{n+1} = (n + 1)(n + 2)$  be first type of Rectangular numbers of ranks  $n-1$  and  $n+1$  respectively such that  $a * b + (a + b) - 2$  is a perfect square say  $x^2$ .

Let  $c$  be any non-zero whole number such that

$$a * c + (a + c) - 2 = y^2 \tag{1}$$

$$b * c + (b + c) - 2 = z^2 \tag{2}$$

From (1) and (2), one may get

$$3(a - b) = y^2(b + 1) - z^2(a + 1) \tag{3}$$

$$\text{Assume } y = m + (a + 1)n \text{ and } z = m + (b + 1)n \tag{4}$$

Using (3) and (4) one may get

$$m^2 = -3 + (b + 1) + (a + 1)n^2 \tag{5}$$

Setting the initial solution as  $n_0 = 1$  and applying in (5) gives  $m_0 = n^2 + n$ .

Now from (4),  $y = 2n^2 + 1$  (6)

Applying (6) in (1) yields the third tuple  $c = 4n^2 + 4n + 3 = 4R_n + 3$ .

Hence the set  $(R_{n-1}, R_{n+1}, 4R_n + 3)$  is a special Dio 3-tuple with property  $D(-2)$ .





**Janaki and Gowri Shankari**

Now let  $d$  be any non-zero whole number such that

$$b * d + (b + d) - 2 = y_1^2 \tag{7}$$

$$d * c + (d + c) - 2 = z_1^2 \tag{8}$$

Introducing the linear transformations,

$$y_1 = m_1 + (b + 1)n_1 \text{ and } z_1 = m_1 + (c + 1)n_1 \tag{9}$$

And using some algebra from (7), (8) and (9), yields

$$d = 9n^2 + 15n + 12 = R_{n+3} + 8R_n.$$

Therefore, the set  $(R_{n+1}, 4R_n + 3, R_{n+3} + 8R_n)$  is a special Dio 3- tuple with property D(-2).

Next consider  $e$  be any non-zero whole number such that

$$c * e + (c + e) - 2 = y_2^2 \tag{10}$$

$$e * d + (e + d) - 2 = z_2^2 \tag{11}$$

Introducing the linear transformations,

$$y_2 = m_2 + (c + 1)n_2 \text{ and } z_2 = m_2 + (d + 1)n_2 \tag{12}$$

And using some algebra from (10), (11) and (12), yields

$$e = 25n^2 + 35n + 30 = R_{n+5} + 24R_n.$$

Therefore, the set  $(4R_n + 3, R_{n+3} + 8R_n, R_{n+5} + 24R_n)$  is a special Dio 3- tuple with property D(-2).

Processing in this way, one may get a half companion sequence of special Dio 3-tuples with the property D(-2) as  $\{(a, b, c), (b, c, d), (c, d, e), \dots\}$ .

Some of the half-companion sequence of special Dio 3-tuples are found and exhibited in the following table:

$n$	$(a, b, c)$	$(b, c, d)$	$(c, d, e)$	$D(-2)$
2	(2,12,27)	(12,27,78)	(27,78,200)	D(-2)
3	(6,20,51)	(20,51,138)	(51,138,360)	D(-2)
4	(12,30,83)	(30,83,216)	(83,216,570)	D(-2)
5	(20,42,123)	(42,123,312)	(123,312,830)	D(-2)
6	(30,56,171)	(56,171,426)	(171,426,1140)	D(-2)

**Remarkable Observations:**

From the above half-companion sequence of special Dio 3-tuples we explore that  $(a, b, c)$  is of the form  $(k^2 + k, k^2 + 5k + 6, 4k^2 + 12k + 11)$  where  $k = 1, 2, 3, \dots$

Similarly  $(b, c, d)$  is of the form  $(k^2 + 5k + 6, 4k^2 + 12k + 11, 9k^2 + 33k + 36)$  where  $k = 1, 2, 3, \dots$  and

$(c, d, e)$  is of the form  $(4k^2 + 12k + 11, 9k^2 + 33k + 36, 25k^2 + 85k + 90)$  where  $k = 1, 2, 3, \dots$

**Establishing that the aforementioned triples cannot be extended to quadruple**

Consider the special Diophantine triple  $(a, b, c)$

Let  $\alpha$  be any other nonzero integer such that

$$a * \alpha + (a + \alpha) - 2 = x_3^2 \tag{13}$$





**Janaki and Gowri Shankari**

$$b * \alpha + (b + \alpha) - 2 = y_3^2 \tag{14}$$

$$c * \alpha + (c + \alpha) - 2 = z_3^2 \tag{15}$$

Eliminating  $\alpha$  from (13) and (15)

$$3(a - c) = x_3^2(c + 1) - z_3^2(a + 1) \tag{16}$$

Applying the linear transformations,

$$x_3 = m_3 + (a + 1)n_3 \text{ and } z_3 = m_3 + (c + 1)n_3$$

$$\text{in (16) gives } m_3^2 = n_3^2(ac + a + c + 1) - 3 \tag{17}$$

Using the initial solutions  $n_3 = 1$  and  $m_3 = 2n^2 + 1$  of (17) the value of  $x_3$  is found as

$$x_3 = 3n^2 - n + 2$$

Substitute  $x_3$  in (13),  $\alpha = 9n^2 + 3n + 6$

Now substituting the values of  $b$  and  $\alpha$  in L.H.S of (14) yields  $9n^4 + 30n^3 + 43n^2 + 30n + 18$  which is not a perfect square.

Hence the special Dio 3-tuple  $(a, b, c)$  with the property  $D(-2)$  cannot be extended to quadruple.

**Establishing that the aforementioned triples cannot be extended to quadruple**

Consider the special Diophantine triple  $(b, c, d)$

Let  $\beta$  be any other nonzero integer such that

$$b * \beta + (b + \beta) - 2 = x_4^2 \tag{18}$$

$$c * \beta + (c + \beta) - 2 = y_4^2 \tag{19}$$

$$d * \beta + (d + \beta) - 2 = z_4^2 \tag{20}$$

Eliminating  $\beta$  from (18) and (20)

$$3(b - d) = x_4^2(d + 1) - z_4^2(b + 1) \tag{21}$$

Applying the linear transformations,

$$x_4 = m_4 + (b + 1)n_4 \text{ and } z_4 = m_4 + (d + 1)n_4$$

$$\text{in (21) gives } m_4^2 = n_4^2(bd + b + d + 1) - 3 \tag{22}$$

Using the initial solutions  $n_4 = 1$  and  $m_4 = 3n^2 + 7n + 6$  of (22) the value of  $x_4$  is

$$x_4 = 4n^2 + 10n + 9$$

Substitute  $x_4$  in (18),  $\beta = 16n^2 + 32n + 27$

Now substituting the values of  $c$  and  $\beta$  in L.H.S of (19) yields  $64n^4 + 192n^3 + 304n^2 + 240n + 109$ , which is not a perfect square.

Hence the special Dio 3-tuple  $(b, c, d)$  with the property  $D(-2)$  cannot be extended to quadruple.

**Establishing that the aforementioned triples cannot be extended to quadruple**

Consider the special Diophantine triple  $(c, d, e)$

Let  $\gamma$  be any other nonzero integer such that





**Janaki and Gowri Shankari**

$$c * \gamma + (c + \gamma) - 2 = x_5^2 \tag{23}$$

$$d * \gamma + (d + \gamma) - 2 = y_5^2 \tag{24}$$

$$e * \gamma + (e + \gamma) - 2 = z_5^2 \tag{25}$$

Eliminating  $\gamma$  from (23) and (25)

$$3(c - e) = x_5^2(e + 1) - z_5^2(c + 1) \tag{26}$$

Applying the linear transformations,

$$x_5 = m_5 + (c + 1)n_5 \text{ and } z_5 = m_5 + (e + 1)n_5$$

$$\text{in (26) gives } m_5^2 = n_5^2(ce + c + e + 1) - 3 \tag{27}$$

Using the initial solutions  $n_5 = 1$  and  $m_5 = 10n^2 + 12n + 11$  of (27) the value of  $x_5$  is

$$x_5 = 14n^2 + 16n + 15$$

$$\text{Substitute } x_5 \text{ in (23), } \gamma = 49n^2 + 63n + 56$$

Now substituting the values of  $d$  and  $\gamma$  in L.H.S of (24) yields  $441n^4 + 1302n^3 + 2095n^2 + 1674n + 738$  which is not a perfect square.

Hence the special Dio 3-tuple  $(c, d, e)$  with the property  $D(-2)$  cannot be extended to quadruple.

**Sequence: 2**

**Forming sequence of non-extendable special Dio 3-tuples for first type of Rectangular numbers of ranks  $n-2$  and  $n+2$  with property D(-11)**

Let  $a = R_{n-2} = (n-2)(n-1)$  and  $b = R_{n+2} = (n+2)(n+3)$  be first type of Rectangular numbers of ranks  $n-2$  and  $n+2$  respectively such that  $a * b + (a + b) - 11$  is a perfect square say  $x^2$ .

Let  $c$  be any non-zero whole number such that

$$a * c + (a + c) - 11 = y^2 \tag{28}$$

$$b * c + (b + c) - 11 = z^2 \tag{29}$$

$$\text{Assume } y = m + (a + 1)n \text{ and } z = m + (b + 1)n \tag{30}$$

Using (28), (29) and (30), one may get the third tuple  $c = 4n^2 + 4n + 3 = 4R_n + 3$ .

Hence the set  $(R_{n-2}, R_{n+2}, 4R_n + 3)$  is a special Dio 3-tuple with property D(-11).

Now let  $d$  be any non-zero whole number such that

$$b * d + (b + d) - 11 = y_1^2 \tag{31}$$

$$d * c + (d + c) - 11 = z_1^2 \tag{32}$$

Introducing the linear transformations,

$$y_1 = m_1 + (b + 1)n_1 \text{ and } z_1 = m_1 + (c + 1)n_1 \tag{33}$$

And using some algebra from (31), (32) and (33), yields

$$d = 9n^2 + 21n + 18 = 3[R_{n+2} + 2R_n].$$

Therefore, the set  $(R_{n+2}, 4R_n + 3, 3[R_{n+2} + 2R_n])$  is a special Dio 3-tuple with property D(-11).





**Janaki and Gowri Shankari**

Next consider  $e$  be any non-zero whole number such that

$$c * e + (c + e) - 11 = y_2^2 \tag{34}$$

$$e * d + (e + d) - 11 = z_2^2 \tag{35}$$

Introducing the linear transformations,

$$y_2 = m_2 + (c + 1)n_2 \text{ and } z_2 = m_2 + (d + 1)n_2 \tag{36}$$

And using some algebra from (34), (35) and (36), yields

$$e = 25n^2 + 45n + 38 = R_{n+5} + 24R_n.$$

Therefore, the set  $(4R_n + 3, 3[R_{n+2} + 2R_n], R_{n+5} + 24R_n)$  is a special Dio 3- tuple with property D(-11).

Processing in this way, one may get a half companion sequence of special Dio 3-tuples with the property D(-11) as  $\{(a, b, c), (b, c, d), (c, d, e), \dots\}$ .

Some of the half-companion sequence of special Dio 3-tuples are found and exhibited in the following table:

$n$	$(a, b, c)$	$(b, c, d)$	$(c, d, e)$	$D(-11)$
3	(2,30,51)	(30,51,162)	(51,162,398)	D(-11)
4	(6,42,83)	(42,83,246)	(83,246,618)	D(-11)
5	(12,56,123)	(56,123,348)	(123,348,888)	D(-11)
6	(20,72,171)	(72,171,468)	(171,168,1208)	D(-11)
7	(30,90,227)	(90,227,606)	(227,606,1578)	D(-11)

**Remarkable Observations:**

From the above half-companion sequence of special Dio 3-tuples we explore that  $(a, b, c)$  is of the form  $(k^2 + k, k^2 + 9k + 20, 4k^2 + 20k + 27)$  where  $k = 1, 2, 3, \dots$

Similarly  $(b, c, d)$  is of the form  $(k^2 + 9k + 20, 4k^2 + 20k + 27, 9k^2 + 57k + 96)$  where  $k = 1, 2, 3, \dots$  and

$(c, d, e)$  is of the form  $(4k^2 + 20k + 27, 9k^2 + 57k + 96, 25k^2 + 145k + 228)$  where  $k = 1, 2, 3, \dots$

**Establishing that the aforementioned triples cannot be extended to quadruple**

Consider the special Diophantine triple  $(a, b, c)$

Let  $\alpha$  be any other nonzero integer such that

$$a * \alpha + (a + \alpha) - 11 = x_3^2 \tag{37}$$

$$b * \alpha + (b + \alpha) - 11 = y_3^2 \tag{38}$$

$$c * \alpha + (c + \alpha) - 11 = z_3^2 \tag{39}$$

Eliminating  $\alpha$  from (37) and (39)

$$12(a - c) = x_3^2 (c + 1) - z_3^2 (a + 1) \tag{40}$$

Applying the linear transformations,

$$x_3 = m_3 + (a + 1)n_3 \text{ and } z_3 = m_3 + (c + 1)n_3$$

In (40) gives  $m_3^2 = n_3^2 (ac + a + c + 1) - 12$  (41)

Using the initial solutions  $n_3 = 1$  and  $m_3 = 2n^2 - 2n$  of (41), the value of  $x_3$  is found as





$$x_3 = 3n^2 - 5n + 3$$

Substitute  $x_3$  in (37),  $\alpha = 9n^2 - 3n + 6$

Now substituting the values of  $b$  and  $\alpha$  in L.H.S of (38) yields  $9n^4 + 42n^3 + 55n^2 + 14n + 37$  which is not a perfect square.

Hence the special Dio 3-tuple  $(a, b, c)$  with the property  $D(-11)$  cannot be extended to quadruple.

#### Establishing that the aforementioned triples cannot be extended to quadruple

Consider the special Diophantine triple  $(b, c, d)$

Let  $\beta$  be any other nonzero integer such that

$$b * \beta + (b + \beta) - 11 = x_4^2 \quad (42)$$

$$c * \beta + (c + \beta) - 11 = y_4^2 \quad (43)$$

$$d * \beta + (d + \beta) - 11 = z_4^2 \quad (44)$$

Eliminating  $\beta$  from (42) and (44)

$$12(b - d) = x_4^2(d + 1) - z_4^2(b + 1) \quad (45)$$

Applying the linear transformations,

$$x_4 = m_4 + (b + 1)n_4 \text{ and } z_4 = m_4 + (d + 1)n_4$$

$$\text{in (45) gives } m_4^2 = n_4^2(bd + b + d + 1) - 12 \quad (46)$$

Using the initial solutions  $n_4 = 1$  and  $m_4 = 3n^2 + 11n + 11$  of (46) the value of  $x_4$  is

$$x_4 = 4n^2 + 16n + 18$$

Substitute  $x_4$  in (42),  $\beta = 16n^2 + 48n + 47$

Now substituting the values of  $c$  and  $\beta$  in L.H.S of (43) yields  $64n^4 + 256n^3 + 448n^2 + 384n + 180$  which is not a perfect square.

Hence the special Dio 3-tuple  $(b, c, d)$  with the property  $D(-11)$  cannot be extended to quadruple.

#### Establishing that the aforementioned triples cannot be extended to quadruple

Consider the special Diophantine triple  $(c, d, e)$

Let  $\gamma$  be any other nonzero integer such that

$$c * \gamma + (c + \gamma) - 11 = x_5^2 \quad (47)$$

$$d * \gamma + (d + \gamma) - 11 = y_5^2 \quad (48)$$

$$e * \gamma + (e + \gamma) - 11 = z_5^2 \quad (49)$$

Eliminating  $\gamma$  from (47) and (49)

$$12(c - e) = x_5^2(e + 1) - z_5^2(c + 1) \quad (50)$$

Applying the linear transformations,

$$x_5 = m_5 + (c + 1)n_5 \text{ and } z_5 = m_5 + (e + 1)n_5$$

$$\text{in (50) gives } m_5^2 = n_5^2(ce + c + e + 1) - 12 \quad (51)$$

Using the initial solutions  $n_5 = 1$  and  $m_5 = 10n^2 + 14n + 12$  of (51) the value of  $x_5$  is





$$x_5 = 14n^2 + 18n + 16$$

Substitute  $x_5$  in (47),  $\gamma = 49n^2 + 77n + 66$

Now substituting the values of  $d$  and  $\gamma$  in L.H.S of (48) yields  $441n^4 + 546n^3 + 715n^2 + 338n + 457$  which is not a perfect square.

Hence the special Dio 3-tuple  $(c, d, e)$  with the property  $D(-11)$  cannot be extended to quadruple.

## CONCLUSION

We explore a unique non-extendable half-companion sequence  $\{(a, b, c), (b, c, d), (c, d, e), \dots\}$  of special 3-tuples for the first type of rectangular numbers with the attributes  $D(-2)$  and  $D(-11)$ . Ultimately, one may explore alternative sequences of triples, quadruples, and so on for different numbers exhibiting suitable attributes.

## REFERENCES

1. R.D. Carmichael, History of Theory of Numbers and Diophantine Analysis, Dover Publication, Newyork,1959.
2. L.J. Mordell, Diophantine equations: Academic Press, London, 1969.
3. T. Nagell, Introduction to Number theory, Chelsea Publishing Company, Newyork, 1981.
4. L. K.Hua, Introduction to the Theory of Numbers, Springer-Verlag, Berlin-Newyork, 1982.
5. Oistein Ore, Number theory and its History, Dover publications, Newyork, 1988.
6. M. N. Deshpande, Families of Diophantine Triplets. *Bulletin of the Marathwada Mathematical Society*, 4, 19-21, 2003.
7. Y. Fujita, The extendibility of Diophantine pairs  $\{k-1, k+1\}$ , *Journal of Number Theory*, 128, 322- 353, 2008.
8. G. Janaki and C. Saranya, Special Dio 3-tuples for pentatope number, *Journal of Mathematics and Informatics*, 11, 119-123, 2017.
9. G. Janaki and C. Saranya, Construction of the Diophantine Triple involving Pentatope Number, *International Journal for Research in Applied Science & Engineering Technology*, 6(3), 2317-2319, 2018.
10. S. Vidhya and G. Janaki, Construction of the Diophantine triple involving Pronic number, *International Journal for Research in Applied Science and Engineering Technology*, 6(1), 2201-2204, 2018.
11. G. Janaki and A. Gowri Shankari, Generating Dio-3 Triples using the Second-Order Polynomials with Incisive Properties, *METSZET Journal*, 8(3), 286-291, 2023.
12. P. Saranya and G. Janaki, Half companion sequences of Dio 3-tuples from  $\frac{CC_n}{Gno_n}$ , *IJSART*; 4(4), 3013-3015, 2018.
13. G. Janaki and C. Saranya, Half companion sequences of special Dio 3-tuples involving Centered square numbers, *International Journal for Recent Technology and Engineering*.; 8(3), 3843-3845, 2019.
14. C. Saranya and G. Janaki, Some Non-extendable Diophantine Triples involving centered square numbers. *International Journal of Scientific Research in Mathematical and Statistical Sciences*, 6(6), 105-107, 2019.
15. S. Vidhya and G. Janaki, Elevation of Stella Octangula number as a special Dio 3-tuples and the non-extendability of special Dio quadruple. *Adalya Journal*, 8(8), 621-624, 2019.





## Impact of Emotional Intelligence and Spiritual Intelligence on Achievement Motivation: A Review

Sanghamitra Das<sup>1</sup>, Charu Dhankar<sup>2\*</sup> and Jyotika Sharma<sup>3</sup>

<sup>1</sup>Research Scholar, Department of Psychology, Manipal University Jaipur, Jaipur, Rajasthan, India.

<sup>2</sup>Assistant Professor, Department of Psychology, Manipal University Jaipur, Jaipur, Rajasthan, India.

<sup>3</sup>Assistant Professor, Department of Psychology, Sikkim Manipal University, Gangtok, Sikkim, India.

Received: 30 Jan 2024

Revised: 09 Feb 2024

Accepted: 26 Apr 2024

### \*Address for Correspondence

**Charu Dhankar**

Assistant Professor,

Department of Psychology,

Manipal University Jaipur,

Jaipur, Rajasthan, India.



This is an Open Access Journal / article distributed under the terms of the **Creative Commons Attribution License** (CC BY-NC-ND 3.0) which permits unrestricted use, distribution, and reproduction in any medium, provided the original work is properly cited. All rights reserved.

### ABSTRACT

Emotional intelligence has become an intriguing topic of research in recent times. Various studies have proved its importance and relation with constructs like personality, leadership qualities, achievement motivation etc. It is defined as the potential of an individual to realize his/ her emotions and manage them. There exists another form of intelligence, Spiritual intelligence which is an ability of a person to use spiritual resources and qualities to improve their daily functioning. Both of these forms of intelligence have an impact on achievement motivation i.e. need or desire to achieve desired goals. The literature suggests that both Emotional intelligence and Spiritual intelligence have positive and distinctively significant relation with achievement motivation. The paper is an attempt to study the relation of these two forms of intelligence with achievement motivation and several other construct which are affected by them.

**Keywords:** Emotional intelligence, Spiritual intelligence, Achievement motivation.

### INTRODUCTION

Emotional intelligence can be defined as potential of an individual to recognize his/her emotions and manage them. It refers to one's capability to recognize, regulate emotions in ourselves and others (Goleman). It is mostly understood as a combination of non cognitive skills, competencies and many more capabilities of an individual that help us deal with the need of the environment (Bar-on). The term "Emotional intelligence" was initially used by Mayer and Salovey. It comprises of various set of skills namely: A) Emotional awareness i.e. the ability to recognize and label one's own emotions B) Ability to regulate emotions and use those emotions in problem solving C) Ability





**Sanghamitra Das et al.,**

to manage those emotions which refers not only to synchronize one's own emotions but to also help others in doing so. In 1960, Salovey inscribed the standard thoughts about emotions by considering it as "high order of intelligence". This notion proposed by him got support from Peter Salovey and John Mayer. They postulated that in order to adapt to certain conditions, one requires cognitive abilities and emotional skills which in turn guide one's behavior. A theoretical framework for emotional intelligence was devised by Salovey and Mayer which consists of three vital components: A) Appraisal and expression, B) Regulation C) Utilization. A four – branch ability model was propounded by Salovey and Mayer which tells us that skills required for reasoning of emotions can be learned. Branch one includes skills needed in perceiving and expression of emotions. Basically, it requires ability to catch emotional cues which can be expressed through facial expressions or voice. Paying attention to physical state of a person is a key in understanding his/her psychological states. It also includes expressing emotions in an appropriate way and to distinguish between authentic and inauthentic emotions. Branch two lays importance on using emotions for facilitation of thoughts. It indicates that more a person uses his/her emotions while making a good decision, greater is the increase in his/her emotional intelligence. It includes the potential to use one's emotions in creativity and problem solving. Branch three focuses on the skills which are crucial in understanding emotions. It includes ability of understanding relationships among different emotions, to identify and understand the antecedents and consequences of emotions and transformation in emotions. Branch four highlights skills one need to regulate emotions. Although, managing of emotions is not an easy task as one finds it hard to balance it since too much regulation may result in repression of emotions by a person whereas too little regulation may make one's emotional life irresistible. The emotionally intelligent people are aware of their own emotional states.

They can identify and label various emotional states they go through and as a result they have high level of self confidence. These people find it easy to regulate or keep a check on their emotions and are high in resilience. People high in emotional intelligence are intrinsically motivated towards their task and have a positive approach towards hurdles or obstacles they face in their life. On the contrary, Spiritual intelligence is considered as the capability to recognize, identify and organizing skills as well as capabilities required for being spiritual. (Emmons, 1999). Spiritual word has been inferred from the Latin word Spiritus, meaning "that gives life or vitality to a person." (Zohar, 1997). The word "Spiritual intelligence" was coined by Zohar. Spiritual relates to religion or religious belief which affects the human soul as opposed to materialistic objects. Spirituality is search of the sacred (Kenneth Pogament). It refers when an individual has a sense or feels connected to something bigger than life and also search for the greater meaning in life. of connection It refers to a universal human experience. Spiritual Intelligence is a kind of intelligence where we address a problem and try to solve it by considering meanings and values in life. Through this we give our action and life a different perspective and meaning, with this we can assess the course of action or the life path which is more meaningful in nature (Zahar& Marshall, 2000). Emmons asserted that "spiritual intelligence can be viewed as a form of intelligence because it predicts functioning and adaptation and offers capabilities that enable people to solve problems and attain goals." He suggested 5 components of spiritual intelligence, namely :

- a. Utilizing spiritual resources in problem solving;
- b. Our capability to gain higher states of awareness;
- c. capabilities to understand and relate to our day to day events in life;
- d. capacity of being more superior than just confining our self to physical and material world;
- e. Ability to be normally, ethically sound.

Spiritual intelligence is described as having the potential to feel, apply, personify spiritual needs and demands for enhancing our day to day functioning and overall wellbeing (Amram, 2007). It is the ability to recognize our various stages of consciousness; awareness of our spiritual needs; and recognizing and being aware of our relation with the transcendent world, the people around us, and to the environment (Vaughan, 2002). Her believe was that every human is spiritually intelligent and can be inculcated through different forms of practices or training. It can be described as "the human capacity to ask ultimate questions about the meaning of life. It involves more than a set of mental abilities, a position which abandons practically all previously established criteria for intelligence. It is the ability to sense a spiritual dimension of life; which allows one to solve particular types of problems, primarily those





Sanghamitra Das et al.,

of a spiritual or moral nature. Spiritual intelligence exists as a potential and innate human ability, which can be developed with training and experience” (Wolman, 2001). The striving to increase, or keep as high as possible, one’s own capability in all activities achievement motivation can be defined as the striving to increase, or keep as high as possible, one’s own capability in all activities Achievement motivation can be defined as the striving to increase or keep as high as possible one’s own capability in all activities in which competition is thought to be involved and where the execution of such activity can, therefore, either succeed or fail (Heckhausen,1967). Dey(2009) put forward the idea that there is a positive effect of emotional intelligence on academic achievement. Various researchers support the opinion that emotions play an important factor for motivation. (Kusche & Greenberg ,2006 ). Sabath believed that emotional intelligence is the root ingredient for arousal of motivation. Emotional intelligence directly influences motivation (Behke, 2009). Achievement motivation is basically a combination of feelings and actions that is connected to strong desire to achieve some standard of excellence in performance that is internalized (Vidler, 1977). Achievement oriented behavior is a combination of various factors that includes a strong desire to avoid failure, the perceived probability to achieve success and the incentive value after achieving the success (Paul, 1982). Need for achievement was recognized for the first time by Henry Murray in his list of “psychogenic” needs. Mc Clelland, John Atkinson and their associates proposed a theory for achievement motivation. Mc Clelland believed that the likelihood of developing a motive is higher when he/she can explain and understand the different aspects of the motive. He asserted that a change in thought and action is likely to take place when the individual can associate the motive to concerned actions. The new motive might make an impact to the thoughts and actions of the individual when he/she can connect it to events in his day to day life.

## OBJECTIVE OF THE STUDY

To review the impact of Emotional intelligence and Spiritual intelligence on achievement motivation

## REVIEW OF LITERATURE

The aim of the current research work is to review the effect of Emotional intelligence and Spiritual intelligence on achievement motivation. In this regard, various significant findings were observed. We hypothesized that there is a positive effect of emotional intelligence and spiritual intelligence on achievement motivation. A study revealed that emotional intelligence is closely linked with the students’ academic achievement (Aminuddin, Tajularipin and Rohaizan, 2009). A study concluded that Spiritual intelligence plays a major role in various academic domains (Saidy, Rahman, Ismail, & Krauss, 2009). The review assessed the pre existing testament that there exists a positive relation between emotional intelligence and achievement motivation (Roy,B., Sinha,R., Suman,S,2013). Another study revealed that emotional intelligence is positively and significantly associated with the respondents’ academic achievement (Akmal, Mohzan, Hassan, Halil, 2013). A study discovered that there exists a significant relationship between Emotional intelligence and other constructs like personality, leadership, conflict handling, and academic achievement (Mehta, S., Singh N., 2013). A research suggested that higher level of spiritual intelligence indicated higher level of achievement motivation in students. It plays an important role for achieving desired goals among students (Siddiqui.Z, 2013). A study reviewed that Spiritual intelligence guides adolescents to seek their goals and meaning in life and motivates them to move in a path that is beneficial for them (Mishra.P, Vasisht.K, 2014). In a study conducted on undergraduate students, concluded that there exists a significant positive relation between emotional intelligence and achievement motivation. It was also evident from the research that students with high emotional intelligence have high achievement motivation (Datta,P.,2015). A study revealed that Emotional intelligence assists employees in adapting to organization’s environment, increases empathy, developing leadership qualities and facilitates decision making (Kannaiah, D., Shanthi, R., 2015). Another study pointed out that Spiritual intelligence helps in strengthening the mental health of an individual by promoting self confidence (Sharma& Arif, 2015). A study unveiled that achievement motivation and emotional intelligence are positively and very strongly related to each other (Sontakke P.J.,2016). A study concluded that women are more Emotionally Intelligent than men, several components like age; salary etc. may also have a role in their performance (Dhani. P., Sharma. T., 2017).





Sanghamitra Das et al.,

In a study it was discovered that spiritual intelligence contributed to academic achievement for students and spiritual intelligence motivates them to make more out of their tasks (Midi, M.M., Cosmas,G, Sinik,S, 2019).

## CONCLUSION

On the basis of this review, it is noteworthy to conclude that Emotional intelligence and Spiritual intelligence has a strong and significant effect on achievement motivation. Emotional intelligence helps employees in adapting to organization's environment and facilitates decision making. Emotional intelligence also has a significant relationship with variables like personality, leadership qualities and conflict handling. It also helps in increasing empathy among employees. Women tend to be more emotionally intelligent than men. Individuals who are high in this aspect of intelligence are high in resilience; such people are intrinsically motivated towards their task and have a positive outlook towards obstructions in their life. It is a strong predictor of job performance. It allows people to think more constructively. Emotional intelligence and Spiritual intelligence work as an accelerator to boost achievement motivation in people. The higher an individual is in these two areas of intelligence; higher is his/her achievement motivation. These two aspects of intelligence guide an individual to perform better in his/her career. Spiritual intelligence has a positive impact on mental health of individual and helps them in achieving desired goals. It helps in adding meaning to life and is responsible for promoting self confidence in people. It also plays a major role in enhancing daily functioning and well being in individuals. People high in this area of intelligence can see a connection between elements. The constraints of this review study is the limited number of studies taken in consideration because of which it tends to be concrete and hence, cannot be generalized on a larger set of population. In addition to this, several other factors contributing in achievement motivation of an individual also need to be examined.

## REFERENCES

1. Akmal, M., Mohzan, M., Hassan, N., Halil, N.A. (2013). The influence of Emotional Intelligence on Academic Achievement. *Procedia- Social and Behavioral Sciences*, 90, 303-312.
2. Aminuddin, H., Tajularipin,S.& Rohaizan,I. (2009). Philosophy underlying emotional intelligence in relation to level of curiosity and academic achievement of rural area students. *Journal of Social Sciences*, 5(2), 95-103.
3. Datta, P. (2015). Emotional intelligence in relation to academic achievement of undergraduate students. *Research Nebula*, 206,208.
4. Dey,N. (2009). Influence of emotional intelligence on academic self efficacy and achievement. *Psycho-lingua*, 39, 171-174.
5. Dhani, P., Sharma, T. (2017). Effect of Emotional Intelligence on job performance of IT employees: A gender study. *Procedia Computer Science*, 184.
6. Kannaih, D., Shanthi, R. (2015). A study on Emotional intelligence at workplace. *European Journal of Business and Management*, 154.
7. Mehta, S., Singh, N. (2017). A review paper on emotional intelligence: Models and relationship with other constructs. *Interantional Journal of Management & Information Technology*, 349.
8. Midi, M.M., Cosmas, G.,Sinik, S. (2019). The Effects of Spiritual intelligence on academic achievement and psychological well being of youths in Kanbuingan village, Pitas.*Southeast Asia Psychology Journal*, 8.
9. Mishra,P., Vasisht,K. (2014). A review study of spiritual intelligence, stress and well being of adolescents in 21<sup>st</sup> century. *Impact journals*,21.
10. Roy,B., Sinha, R., Suma,S.(2013). Emotional Intelligence and Academic Achievement Motivation among Adolescents: A Relationship Study. *Journal of Arts, Science & Commerce*, 129.
11. Saidy, H., Rahman, J., Ismail, I, Krauss, S. (2009). Influence of emotional and spiritual intelligence from that national education philosophy towards language skills among secondary school students. *European Journal of Social Science*, 9(1), 70,71.





**Sanghamitra Das et al.,**

12. Sharma, B., & Arif, A. (2015). Spiritual intelligence, self esteem and mental health status among the school going adolescents, *Indian Journal of Positive Psychology*, 6(3), 237.
13. Siddiqui, Z. (2013). Effect of achievement motivation and gender on spiritual intelligence. *Educationia Confab*, 41.
14. Snyder, C.R. Lopez, S.J. (2007). *Positive Psychology*. New Delhi; Sage publications
15. Sontakke, P.J. (2016). Achievement Motivation and Emotional Intelligence: A correlational Study. *The International Journal of Indian Psychology*, 128.
16. Srivastava, Prem (2016). Spiritual intelligence: An overview. *International journal of multidisciplinary research and development*, 224-225.
17. Vaughan, F. (2002). What is spiritual intelligence? *Journal of Humanistic Psychology*, 42, 16-33.
18. Wolman, R.N. (2001). *Thinking with your soul: Spiritual intelligence and why it matters*. New York: Harmony Books.
19. <https://www.psychologytoday.com/basics/emotional-intelligence>
20. <https://www.psychologydiscussion.net/theory/theories-of-motivation/theories-of-motivation-4-theories-psychology/13514>





## Growth, Optical, Electrical, Fluorescence and Mechanical Characterization of 4-Aminobenzoic Acid Single Crystal

I. Shubashini<sup>1</sup> and S. Robinson Jebas<sup>2\*</sup>

<sup>1</sup>Research Scholar (Reg.No. 21111062132003), Department of Physics, Kamarajar Government Arts College, Surandai, Tenkasi, (Affiliated to Manonmaniam Sundaranar University, Abishekapatti, Tirunelveli) Tamil Nadu, India.

<sup>2</sup>Associate Professor, Department of Physics, Kamarajar Government Arts College, Surandai, Tenkasi, (Affiliated to Manonmaniam Sundaranar University, Abishekapatti, Tirunelveli) Tamil Nadu, India.

Received: 30 Jan 2023

Revised: 09 Feb 2024

Accepted: 26 Apr 2024

### \*Address for Correspondence

**S. Robinson Jebas**

Associate Professor,

Department of Physics, Kamarajar Government Arts College,

Surandai, Tenkasi, (Affiliated to Manonmaniam Sundaranar University, Abishekapatti, Tirunelveli) Tamil Nadu, India.

Email:jebas2@gmail.com



This is an Open Access Journal / article distributed under the terms of the **Creative Commons Attribution License** (CC BY-NC-ND 3.0) which permits unrestricted use, distribution, and reproduction in any medium, provided the original work is properly cited. All rights reserved.

### ABSTRACT

4-Aminobenzoic acid (4-ABA) was grown by slow evaporation method. The grown crystal was characterized using UV-Vis-NIR spectrum for its suitability for optical applications. The various optical constants such as absorption co-efficient, extinction coefficient, reflectance, refractive index, optical conductivity, electrical conductivity and susceptibility have been determined from the UV-Vis transmission plot. The wide transparency window indicates the suitability of the crystal for optoelectronic device fabrication. Fluorescence studies revealed that the excitation peak is observed at 400 nm and the corresponding emission was observed at 770nm. Mechanical study was carried out using Vickers micro hardness to find the work hardening coefficient, yield strength and elastic stiffness constant of the crystal. The work hardening index ( $n$ ) is more than 2 indicate that the crystal belongs to soft material.

**Keywords:** optical conductivity; electrical conductivity; excitation; emission; elastic stiffness.





## INTRODUCTION

The search of novel organic materials has been continuing for more than few decades due to the many advantages over inorganic materials. Materials which exhibit excellent optical properties are being used in the field of optical communication, frequency doubling and optoelectronics device fabrication [1–5]. This is because of their efficient physicochemical properties such as molecular nonlinearity over a broad frequency range, low cost, low dielectric constant, inherent synthetic flexibility, high optical damage threshold ( $>10$  GW/cm<sup>2</sup>), ultrafast response with better process ability, ease of fabrication and possible integration into devices. 4-Aminobenzoic acid (4-ABA) is one of the well-known carboxylic acids promoting molecular self-assembly by means of strong hydrogen bonding through its carboxylic acid group [6–10]. As 4-ABA can donate and also accept hydrogen, it has proved to be one of the most versatile reagents for structure extension by linear hydrogen bonding associations, through both the carboxylic acid and amine functional groups [11]. This property of extension was recognized as a possible tool for promoting crystallization, with the aim of designing non Centro symmetric organic materials [12]. We have already reported the UV-Vis NIR transmittance and absorption spectrum and derived band gap energy from Tauc's plot of the title compound [13]. 4-ABA shows a lower cut-off wavelength of 250 nm. The lower cut-off wavelength indicates the suitability of the material for optoelectronic applications. The band gap energy is calculated as 3.5 eV from the Tauc's plot. In this research article, various optical constants such as refractive index, reflectance, optical conductivity, electrical conductivity, electric susceptibility, fluorescence and mechanical studies of 4-ABA crystal have been extensively discussed

## MATERIALS AND METHODS

4-Aminobenzoic acid purchased from Otto chemicals was dissolved in 30 ml ethanol without further purification. The clear solution obtained was allowed to evaporate slowly. After three weeks, pale yellow crystals were obtained. Figure 1 shows the chemical diagram of the 4-ABA. Figure 2 shows the grown crystals.

## RESULTS AND DISCUSSION

### Optical Studies- UV Vis NIR

The optical absorption spectrum indicates that the crystal has lower cut off wavelength of about 250 nm. From the absorption spectrum, it can be observed that there is less absorbance in the entire visible and near-infrared region. The wide transparency and lower cut off wavelength is one of the requirements for the materials to exhibit efficient optoelectronics character [14]. The absorption peak at 300 nm is due to  $\pi$  to  $\pi^*$  transition of the compound which is shown in figure 3. The optical absorption coefficient is calculated from the below formula

$$\alpha = \left( \frac{2.303I_0}{I} \right) \log \frac{1}{t} \text{m}^{-1} \quad (1)$$

### Determination of optical constants

The extinction coefficient (K) is the fraction of light loss due to scattering and absorption per unit distance in a material. The extinction coefficient (K) of the material is calculated from the expression [15],

$$K = \frac{\alpha\lambda}{4\pi} \quad (2)$$

Where  $\alpha$  is the optical absorption coefficient,  $\lambda$  is the wavelength. The plot of wavelength vs extinction coefficient ( $\alpha$ ) is shown in Figure 4. The decrease in extinction coefficient with increase in wavelength shows that the fraction of light loss due to scattering and absorbance decreases. The reflectance provides the ratio of the energy of reflected to incident light from the crystal. The reflectance (R) in terms of absorption coefficient ( $\alpha$ ) and the thickness of the crystal (t) can be determined using the relation [16]

$$R = 1 \pm \frac{\sqrt{1 - \exp(-\alpha t) + \exp(\alpha t)}}{1 + \exp(-\alpha t)} \quad (3)$$





### Shubashini and Robinson Jebas

The reflectance as the function of wavelength is graphically illustrated in Figure 5. The reflectance decreases as the wavelength increases is observed from the plot. The refractive index is the measure of the speed of light in the material. It is the key parameter for optical device design. The refractive index ( $n$ ) was calculated using the relation [17, 18]

$$n = \frac{-(R+1) \pm \sqrt{-3R^2 + 10R - 3}}{2(R-1)} \quad (4)$$

The plot of wavelength versus refractive index is shown in shown in Figure 6. In general, the refractive index decreases with increasing wavelength. The reflectance  $R$  can be calculated from the below relation,

$$R = \frac{(n-1)^2}{(n+1)^2} \quad (5)$$

The extinction coefficient  $K = 2.687 \times 10^{-8}$ , reflectance  $R = 0.20$ , refractive index of 4-ABA crystal is calculated as  $n = 2.56$ .

#### Optical Conductivity

The optical response of a material is studied in terms of optical conductivity. The study of optical conductivity gives the electronic states in materials. Optical conductivity ( $\sigma_{op}$ ) is calculated using the relation [19],

$$\sigma_o = \frac{\alpha n c}{4\pi} \quad (6)$$

Where  $c$  is the velocity of light,  $\alpha$  is the optical absorption coefficient and  $n$  is the refractive index. The plot of wavelength vs optical conductivity is shown in Figure 7. The optical conductivity has higher values of  $3.25 \times 10^8 \text{ S}^{-1}$  in the visible region around 750 nm. The plot of energy versus optical conductivity is shown in Figure 8.

#### Electrical Conductivity

Electrical conductivity is the ease with which an electric charge or heat can pass through a material. The value of electrical conductivity of a material is related with the optical conductivity of the crystal using the equation [20],

$$\sigma_e = \frac{2\lambda\sigma_o}{\alpha} \quad (7)$$

Figure 9 and Figure 10 shows the electrical conductivity characteristics of the material 4-ABA. The electrical conductivity increases as the wavelength increases and electrical conductivity decreases as the energy ( $h\nu$ ) increases.

#### Electric susceptibility

The electric susceptibility ( $\chi_e$ ) values are estimated using the calculated extinction coefficient and refractive index values of the crystal using the relation as mentioned below [21],

$$\epsilon_r = \epsilon_0 + 4\pi\chi_e = n^2 - k^2 \quad (8)$$

$$\chi_e = n^2 - k^2 - \epsilon_0/4\pi \quad (9)$$

Where  $\epsilon_0$  is the permittivity in free space. The complex dielectric constant is given by  $\epsilon_c$ . The real and imaginary part of dielectric constant from extinction coefficient is given as [22, 23].

$$\epsilon_c = \epsilon_r + \epsilon_i \quad (10)$$

$$\epsilon_r = n^2 - k^2 \quad (11)$$

$$\epsilon_i = 2nk \quad (12)$$

Where  $\epsilon_r$  and  $\epsilon_i$  are real and imaginary part of dielectric constant. The electric susceptibility is calculated as  $\chi_e = 0.5738$ . The real  $\epsilon_r$  and imaginary  $\epsilon_i$  values of dielectric constant 7.9511 and  $1.187 \times 10^{-7}$ .

#### FLUORESCENCE SPECTRAL ANALYSIS

Fluorescence may be expected generally in molecules that are aromatic or contain multiple conjugated double bonds with a high degree of resonance stability [24]. The fluorescence is the most crucial nondestructive tool to evaluate the defects, surface interfaces and transition associated with the energy states. It therefore finds huge application in biomedical, photonics, and chemical applications [25]. The excitation and emission spectrum of grown 4-ABA crystal was recorded in the range of 400 nm to 900 nm by means of Perkin Elmer model LS-45 fluorescence spectrometer. The excitation peak is observed at 400 nm for 4-ABA and the corresponding emission was observed at 770nm. Figure 11 shows the emission spectrum of 4-ABA. The grown 4-ABA crystal has red fluorescence emission.





### Shubashini and Robinson Jebas

#### MICROHARDNESS ANALYSIS

The mechanical property of the as grown crystal was investigated by measuring the hardness under various applied loads. The hardness of a material is a measure of the resistance it offers to local deformation [26]. It plays a key role in the optical device fabrication. The hardness properties were analyzed using SHIMADZU MHV-G21 series micro hardness tester fitted with the diamond indenter. Indentations were made with a Leitz micro hardness tester. The test was carried out at different load ranges of (10g, 25g, 50g and 100g) with the indentation time of 10s. The hardness of the crystal reveals information about the strength, molecular binding, yield strength and elastic constants of the material [27]. The Vickers hardness parameter ( $H_v$ ) is calculated using the formula [28].

$$H_v = 1.8544(P/d^2) \text{ kg/mm}^2 \quad (13)$$

Where  $P$  is the applied load and  $d$  is the average diagonal length of impressions with square shapes were taken. The value  $H_v$  increases with the increase of load from 20g to 100g which emphasizes reverse indentation size effect (RISE). The hardness decreases with the increasing load (ISE). Figure 12 shows that the hardness increases with the increasing load (RISE). The value  $H_v$  increases with the increase of load from 20g to 100g which emphasizes reverse indentation size effect (RISE). The hardness decreases with the increasing load (ISE). Figure 12 shows that the hardness increases with the increasing load (RISE). An increase in the mechanical strength will have significant effect on NLO device fabrication and processing such as ease in polishing and less wastage due to breakage while polishing [29,30]. The work hardening co-efficient ( $n$ ) of the material is related to the load ( $P$ ) by the relation,

$$P = An^d \quad (14)$$

Where,  $A$  is an arbitrary constant.

$$\log P = \log K + n \log d \quad (15)$$

Here,  $K$ , is material constant, ' $n$ ' is the Mayer index (or) work hardening coefficient. The work hardening coefficient ' $n$ ' of the sample was determined from the slope of the plot of  $\log p$  versus  $\log d$  as in figure 13. These straight line graphs which are in good agreement with Mayer's law. According to Onitsch [31] and Mayer [32] the work hardening coefficient  $n$  value for harder materials should lie between 1 and 1.6 and above 1.6 for softer materials. The value of  $n$  obtained for the grown 4-ABA crystal is 2.5 and belongs to soft material category. Stiffness is a measure of the resistance offered by an elastic body to deformation. The Wooster's empirical stiffness constant ( $C_{11}$ ) for different loads [33],

$$C_{11} = H_v^{7/4} \quad (16)$$

The plot of load versus stiffness is shown in figure 14. The value of stiffness constant for grown crystals is observed to be increasing with the increase of applied load. 4-ABA single crystals indicate that the crystal has the strong binding forces between the ions in the lattice [34, 35].

Yield strength ( $\sigma_v$ ) of the 4-ABA crystal can be found out using the relation [36].

$$\sigma_v = H_v/3 \quad (17)$$

The plot of load vs Yield strength is shown figure 15. Yield strength increases with the increase in load for grown crystal.

#### CONCLUSION

Single crystal 4-Aminobenzoic Acid (4-ABA) was grown by slow evaporation method. The optical parameters like optical conductivity, electrical conductivity and susceptibility of the crystal is calculated from the UV-Visible NIR spectrum. Fluorescence spectral analysis shows the red emission. The 4-ABA crystal is a relatively soft material from the investigation of Micro hardness.







## REFERENCES

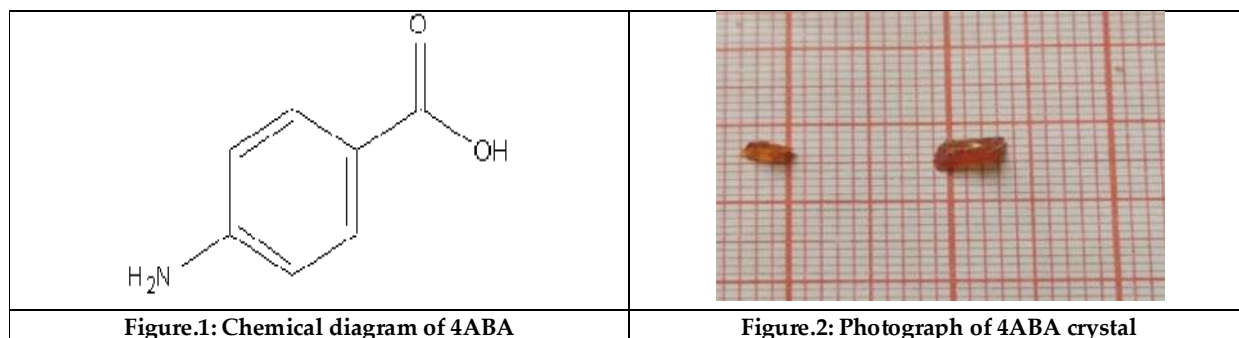
1. Ramamurthy N, Dhanuskodi S, Manjusha MV, Philip. Low power CW optical limiting properties of bis 2(aminopyridinium)-succinate-succinic acid (2APS) single crystal. *Journal Optical Mater.* 2011; 33: 607-612.
2. Venkatesan G, Anantha Babu G, Ramasamy P, Chandra Mohan A. Synthesis Structure and characterization of novel metal –organic single crystal: Dibromobis (L-Proline) zinc (II). *Journal of Molecular Structure.* 2013; 1033: 121-126.
3. Munn RW, Ironside CN, Chapman & Hall. Principles and Applications of Nonlinear Optical Materials. *Advanced Material.* 1993;5: 257-262.
4. Jose M, Uthrakumar R, Jeya Rajendran Jerome A, Das S. Optical and spectroscopy studies of potassium p-nitrophenolate dihydrate crystal for frequency doubling application. *Spectrochimica Acta A Molecular and Bio molecular Spectroscopy.* 2012; 86: 495-499.
5. Lin L, Li J, Chen Y, Chen J. Solution growth of on ultra-soft X-ray spectroscopy organic crystal hexadecyl hydrogen maleate. *Journal of Crystal Growth.* 2003;249: 341-344, (2003).
6. Alizadeh K, Morsali A. Crystal Structure of Pyridinyl-2-methylene-4-aminobenzoic acid. *X-ray Structure Anal Online.* 2011; 27: 11-12.
7. Anandhi S, Raja Lakshmi M, Shyju TS, Gopalakrishnan R. Growth and Characterization of an Adduct 4-Aminobenzoic Acid with Nicotinic Acid. *Journal of Crystal Growth.* 2011; 318: 774-779.
8. Seaton C, Chadwick K, Sadiq G, Guo K, Davey RJ. Designing Acid/Acid Co-Crystals through the Application of Hammett Substituent Constants. *Crystal Growth Design.* 2010; 10: 726-733.
9. Ueda M, Onishi H, Nagai T. Structure of p-amino benzoic acid-1,3-dimethyl-2-imidazolidinone(1/1). *Acta Crystallography Section C.* 1986; 42: 385-389, (1986).
10. Etter MC, Franken Bach GM. Hydrogen-bond directed co crystallization as a tool for designing acentric organic solid. *Chemical Materials.* 1989; 1: 10-12.
11. Gracin S, Rasmuson AC. Polymorphism and Crystallization of p-Amino benzoic Acid. *Crystal Growth Design.* 2004; 4: 1013–1023.
12. Etter MC, Franken Bach GM. Hydrogen-bond directed co crystallization as a tool for designing acentric organic solid. *Chemical Materials.* 1989; 1: 10-12.
13. Shubashini I, Samuel Robinson Jebas. Growth and Characterization of 4ABA Single crystal. *Proceeding of National conference on Recent Development in Effective Materials REDEEMS'23.* 2023; 6-7.
14. Amutha M, Raj Kumar R, Thayanihi V, and Praveen kumar. Growth and characterization of Benzimidazolium Salicylate: NLO property from a Centro symmetric crystal. *Advances in optical Technologies.* 2015; 2015: 1-9. (2015).
15. Samuel Robinson Jebas, Anantha Meena Geetha J, Jeba Flora, Sathya bama. Spectral, Optical and Electrical Characterization of 1-(2-Hydroxyethyl)-2-Methyl-5-Nitroimidazole (Metronidazole) Single Crystal. *International journal of Progressive Research in Science and Engineering.* 2022; 3: 109-114.
16. Job CB, Shabu R, Paul raj S. Growth, structural, optical, and photo conductivity studies of potassium tetra fluoro antimonite crystal. *Optik – International Journal of light and Electron Optics.* 2016; 127: 3783-3787.
17. Ashour A, EI-Kadry N, and Mahmoud SA. The electrical and optical properties of Cds films thermally deposited by a modified source. *Thin Solid films.* 2000; 269: 155-162.
18. Kaid MA, Ashour A. Preparation of ZnO-doped Al films by spray pyrolysis technique. *Applied Surface Science.* 2006; 253: 3029-3033.
19. Hiral Raval B, Parekh KD, Parikh MJ and Joshi. Growth and characterizations of organic NLO Imidazolium L-Tartrate (IMLT) single Crystal. *Advances in condensed matter physics.* 2019; 215: 1-9.
20. Dillip G.R, Bhagavannarayana, Raghavaiah P, Deva Prasad Raju. Effect of magnesium chloride on growth, crystalline perfection, structural, optical, thermal and NLO behavior of  $\gamma$ -glycine crystals. *Materials Chemistry and Physics.* 2012; 134: 371-376, (2012).
21. Gupta V, Mansingh A. Influence of post deposition annealing on the structural and optical properties of sputtered zinc oxide film. *Journal of Applied Physics.* 1996; 80: 1063-1073.





## Shubashini and Robinson Jebas

22. KochuparampilAP, JoshiJH, and. Joshi MJ. Growth, structural, spectroscopic, thermal, dielectric and optical study of cobalt sulphide-doped ADP crystals. *Modern Physics Letters B*.2017; 31:27-37.
23. Dhanaraj P, Suthan T, and Rajesh N. Synthesis, crystal growth and characterization of semi organic material: calcium dibromide bis (glycine) tetrahydrate. *Current applied physics*.2010;10: 1349-1353,
24. TurroNJ. *Molecular Photochemistry*. Chemical & Engineering News. 1965; 45: 84-95.
25. Anis M, Shuakat H, Shrisat M, Muley G. Analysis of the X-ray diffraction, etching, luminescence, photoconductivity, thermal and dielectric properties of an ADP crystal influenced by bimetallic additive sodium met silicate (Na<sub>2</sub>SiO<sub>3</sub>).*Materials Research Express*.2016; 3: 106204-106210. (2016).
26. Dhanaraj P, Suthan T, and Rajesh N. Synthesis, crystal growth and characterization of semi organic material: calcium dibromide bis (glycine) tetrahydrate. *Current applied physics*.2010; 10: 1349-1353.
27. Uma J, Rajendran V. Growth and properties of semi-organic nonlinear optical crystal: L-Glutamic acid hydrochloride. *Progress in Natural Science Materials International*.2016; 26:24-31.
28. PaIT, KarT. Studies of micro hardness anisotropy and Young's modulus of nonlinear optical crystal l-arginine hydro chloro bromo monohydrate. *Materials Letter*. 2005; 59: 1400–1404. (2005).
29. SenthilPandian M, Balamurugan N, Ganesh V, RajaPV, Shekar K, Kishan Rao, RamasamyP.Growth of TGS Single Crystal by Conventional and SR Method and Its Analysis on the Basis Of Mechanical, Thermal, Optical and Etching Studies.*Materials Letter* 2008;62: 3830-3832.
30. VijayanN, Bhagavannarayana R, BabuR, MauryaK, and RamasamyP. A Comparative study on solution and Bridgman grown single crystals of Benz imidazole by high-resolution XRD, FTIR, micro hardness, laser damage threshold and SHG measurements. *Crystal Growth and Design*. 2006;6, 1542–1546, (2006).
31. Onitsch EM.The present status of testing the hardness of materials.*Microscope*.1950;95: 12-14.
32. Meyer E. Contribution to the knowledge of hardness and hardness testing German Science. *Journal of Physics*. 1908; 52: 740-835.
33. John J, Christuraj P,Anitha K. Band gap enhancement on Metal chelation: Growth and characterization of cobalt chelated glycine single crystals for optoelectronic applications. *Materials Chemical Physics*.2009;11:284-287. (2009).
34. LawnBR, FullerER. Equilibrium penny-like cracks in indentation fracture. *Journal of Materials science*. 1975; 9: 1-34.
35. West brookJH. Report 58 - RL – 2033 of the G. E Research Laboratory, USA; 1958.
36. Samuel Robinson Jebas, Anantha Meena GeethaJ, Dhana Lakshmi S, Nattamai Bhuvanesh. Spectral, Optical and mechanical characterization of 2-aminothiazole single crystal. *International journal of Applied Engineering Research*.2022; 17: 542-554.



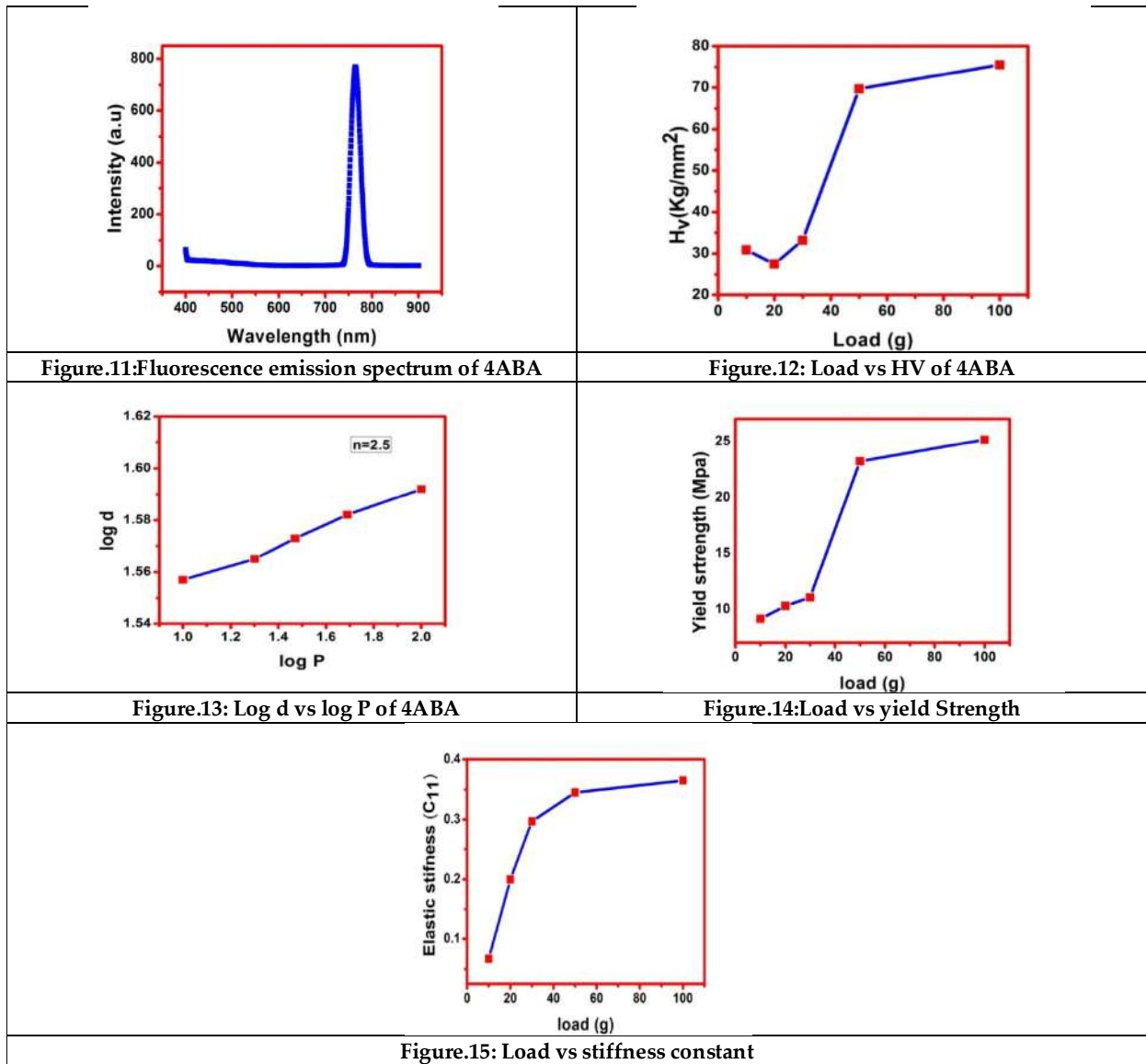


<p>Figure.3: Absorption spectrum of 4ABA</p>	<p>Figure.4: Plot of <math>\lambda</math> versus K of 4ABA</p>
<p>Figure. 5: Plot of <math>\lambda</math> versus R of 4ABA</p>	<p>Figure.6: Plot of <math>\lambda</math> versus n of 4ABA</p>
<p>Figure.7: Plot of <math>h\nu</math> versus <math>\sigma_{op}</math> of 4ABA</p>	<p>Figure.8: Plot of <math>\lambda</math> versus <math>\sigma_{op}</math> of 4ABA</p>
<p>Figure.9: Plot of <math>\lambda</math> versus <math>\sigma_e</math> of 4ABA</p>	<p>Figure.10: Plot of <math>h\nu</math> versus <math>\sigma_{e}</math> of 4ABA</p>





Shubashini and Robinson Jebas





## Management of Electrical Appliances for Smart Home to Regulate Energy Consumption using Arduino and GSM

Krishnaveni S<sup>1\*</sup>, Anguselvi S<sup>2</sup> and Pazhanimurugan R<sup>3</sup>

<sup>1</sup>Associate Professor, Department of Electrical and Electronic Engineering, Sri Sivasubramaniya Nadar College of Engineering, Kalavakkam (Affiliated to Anna University), Tamil Nadu, India.

<sup>2</sup>Assistant Professor, Department of Commerce, Hajee Karutha Rowther Howdia College, Uthamapalayam, Theni (Affiliated to Madurai Kamraj University, Madurai) Tamil Nadu, India.

<sup>3</sup>Associate Professor, Department of Electrical and Electronic Engineering, Arasu Engineering College, Kumbakonam, Thanjavur (Affiliated to Anna University, Chennai) Tamil Nadu, India.

Received: 22 Jan 2024

Revised: 09 Feb 2024

Accepted: 27 Apr 2024

### \*Address for Correspondence

**Krishnaveni S**

Associate Professor,

Department of Electrical and Electronic Engineering,

Sri Sivasubramaniya Nadar College of Engineering,

Kalavakkam (Affiliated to Anna University),

Tamil Nadu, India.

Email: krishnavenis@ssn.edu.in



This is an Open Access Journal / article distributed under the terms of the **Creative Commons Attribution License** (CC BY-NC-ND 3.0) which permits unrestricted use, distribution, and reproduction in any medium, provided the original work is properly cited. All rights reserved.

### ABSTRACT

The technological revolution in major domains has been growing boundlessly and ultimately increases the demand of electrical energy. So, electrical energy has been considered as one of our day-to-day life essentials. However, it is consumed by the public based on payment at regular intervals in most parts of the world. So, each individual works towards reducing energy consumption by implementing different methods. A possible solution to reduce the electric bill is to alert the user by sending SMS whenever the energy consumed crosses its predetermined units or power factor correction methods. This project proposes a cost-effective electrical appliances management system associated with ARDUINO UNO and GSM with built in technology of tracking and controlling the electrical appliances at home. This contributes to a reduced electricity bill and assists the elderly and physically challenged people at home in operating the electrical appliances.

**Keywords:** Relay, Electrical Appliances, Arduino UNO, GSM





Krishnaveni et al.,

## INTRODUCTION

Electrical energy is an essential source when coming to various sectors like household, agricultural, small scale, and big industries. Energy demand by the consumers has drastically increased and so the power sector units have been working on renewable energy production apart from the classical way of production [1-5]. But it is still quite challenging to keep up with everything in this fast-paced world, particularly when it comes to the utilization of electricity [6-8]. The Electricity board informs the customers about their energy consumption at the end of the allocated duration [9-10]. In places like Tamil Nadu (India), different tariff slab rates are followed and moreover the few units above the determined slabs brings a huge difference in the total amount to be paid [11]. Although the payment procedure is different at different places, the smart energy meter technology overtakes the method for measuring electrical energy worldwide [12-14]. Research on the developed smart meter technology must be improved by not only keeping track of energy usage but also considering the modification to send an alert message to the customers at predetermined levels of consumption [15-17]. Hence the smart energy meter helps the customer to monitor the energy consumption and the bill amount thereby creating sustainable energy management and reformation. In the modern world, appliance management has also grown in importance since it enables tasks to be completed more cleverly and with less human intervention [18–20].

In order to minimize peak load demand and maximize energy efficiency, it is also beneficial to arrange the operation of all electrical appliances. Additionally, with the aid of appliance management devices, homes are becoming more sophisticated and intelligent these days. Conventional switches are being replaced by remote-controlled switches for home electrical equipment. Since most people have access to smartphones these days and they are widely used in our daily lives, it is becoming easier to operate the electrical equipment in smart homes [21]. Controllers and communication devices allow for the remote control of household equipment [22–23]. The best option for controlling home appliances with a single click or message is a smartphone. The Global System for Mobile (GSM) module on the Arduino UNO board is suggested for this project's development of Smart Appliances Management. It can be remotely controlled by a smartphone at a lower cost and works with the current meter. Those who are paralyzed and unable to perform tasks on their own may also benefit from it, and these devices can be of great assistance to them. This can also serve a very useful purpose in the event that someone leaves their home without turning on or off a necessary outdoor equipment.

## METHODOLOGY

Most home automation systems use Bluetooth, Voice Recognition, ZigBee, GSM, Internet, Wi-Fi, and other communication technologies to link microcontrollers with smartphones [24]. However, every technology has benefits and drawbacks of its own. The primary goal of this project is to design and create an affordable, user-friendly system that enables a user to conveniently and successfully monitor and operate a variety of household appliances using a smart mobile phone from a distance. The GSM connection and Short Message Service (SMS) is the foundation for the bidirectional connection between the mobile phone and the home appliance. The system's block diagram is depicted as shown in Figure 1. It shows the different hardware parts of the system as well as how SMS-based communication functions aid the user in controlling and monitoring household appliances. Through the GSM network, the user transmits the SMS message to the GSM modem as a text message in a predetermined format. The GSM Module extracts the keyword in the text message received and acknowledges the user. Only SMS messages sent to pre-configured mobile numbers within the system are accepted by the software. The message's content is examined by the Arduino UNO to determine the action the user wishes to take. If the received keyword does not match with the desired keyword, then the whole operation stops. Finally, a relative result is also printed on a 16x2 LCD Display by using appropriate commands. The household appliances are controlled by commands such as "#A.light on\*," "#A.light off\*," and so on. Relays are signaled by Arduino to turn on and off household appliances via relay drivers once Arduino has received commands over GSM. In this case, the command string prefix "#A." is



**Krishnaveni et al.,**

utilized. The prefix "\*" at the end of the string indicates that the message has ended, and it is used to identify the main command that follows it. The list of SMS messages that the user uses to turn on and off the fan, light, and television is included in Table 1.

## RESULTS AND DISCUSSION

Proteus Professional Software is a special tool set for automating electronic design that is used for circuit simulation. This tool is mostly used by design engineers to generate electronic prints and schematics for printed circuit board manufacturing. It is available in many configurations, contingent upon the size of the designs being generated and the requirements for microcontroller simulation. Every PCB Design solution comes with basic mixed mode SPICE simulation capabilities. The simulation circuit is depicted in Figure 2, and this package includes extremely simple connections for the GSM-based appliances management circuit. A liquid crystal display that is directly connected to an Arduino running in 4-bit mode displays the status of household appliances. The LCD's RS, EN, D4, D5, D6, and D7 data lines are connected to digital pin numbers 6, 7, 8, 9, and 10 on the Arduino board. Moreover, the Tx and Rx pins of the GSM module are linked directly to the Arduino's Tx and Rx pins. The GSM module is also powered by a 12-volt adapter. To control lights, fans, and televisions, relays with a 5-volt Single pole and Double throw (SPDT) output are utilized. Furthermore, pins 3, 4, and 5 of the Arduino are connected to relay drivers ULN2003, which regulate the lighting, fans, and television, in that order.

In the project's programming section, the data and control pins for LCDs and household appliances are first created before including a library for LCDs display. Following this, the serial communication (UART) is set at 9600 bps and the utilized pins for the electrical appliances are initiated. The comments for LCD and the initiation of UART are represented in figures 3.1 and 3.2 respectively. The program flow started with two functions are used to receive data serially and shown in Figure 4. The function Serial. Available determines whether any serial data is arriving, and the function Serial. Read reads the serially arriving data. The serially received data has been put in a string after getting it and waits for Enter press. When enter is pressed, the program begins by comparing the string that has been received with the string that has previously been defined. If the strings match, a relative action is then carried out using the relevant command that has been provided in the code. Figure 5 shows the hardware implementation of proposed electrical appliances management system. The project's hardware implementation has been completed, and the results are as follows. The description of the major components used is given in Table 2. The components are put together and connected according to the simulation diagram. The components are tested during the initial step, and the sensing process is carried out to provide the desired output. The LEDs are used instead of actual loads for the testing purpose.

## CONCLUSION

This paper deals with the brief introduction about the Appliances management using Arduino UNO and GSM Module, and includes the components required, Working and Operation of the project. As a result, the consumer is aware of the power consumption and manages it effectively with the help of the appliances management concept. This leads to the sustainable management of energy. Currently the system is at the prototype stage. So, there are limitations for this system which brings about the need for further improvements. The Arduino board is equipped with a limited number of digital and analog I/O pins. Hence, the system can connect a few numbers of appliances. Besides that, design, and development of a microprocessor-based circuit board to connect GSM modem, Arduino board, Webcam and upgrade program running into microprocessor will result a compact embedded system and can operate without user interaction.



**Krishnaveni et al.,****REFERENCES**

1. A. Qazi, Fayaz Hussain, Nasrudin ABD. Rahim, Glenn Hardaker, Daniyal Alghazzawi, Khaled Shaban, Khalid Haruna, "Towards Sustainable Energy: A Systematic Review of Renewable Energy Sources, Technologies, and Public Opinions," IEEE Access, vol. 7, pp. 63837-63851, 2019.
2. Ravindranath Tagore, Y, Rajani, K, Anuradha, K, "Dynamic analysis of solar powered two-stage dc-dc converter with MPPT and voltage regulation", International Journal of Dynamics and Control, vol. 10, pp.1745–1759, 2022.
3. M. Jayakumar, V. Vanitha, V. Jaisuriya, M. Karthikeyan, George Daniel, T. Vignesh, "Maximum power point tracking of a solar PV array using single stage three phase inverter", International Journal of Engineering & Technology, vol. 7, pp. 97-100, 2018.
4. Rajanand Patnaik Narasipuram, Chaitanya Somu, Ravindranath Tagore Yadlapalli, Lakshmi Sirisha Simhadri, "Efficiency analysis of maximum power point tracking techniques for photovoltaic systems under variable conditions", International Journal of Innovative Computing and Applications, vol. 9, No. 4, 2018.
5. J. A. Paravantis, E. Stigka, G. Mihalakakou, E. Michalena, J. M. Hills and V. Dourmas, "Social acceptance of renewable energy projects: A contingent valuation investigation in Western Greece", Renewable Energy, vol. 123, pp. 639-651, 2018.
6. A.L. Paladugula, N. Kholod, V. Chaturvedi, P.P. Ghosh, S. Pal, L. Clarke, S. A. Wilson, "A multi-model assessment of energy and emissions for India's transportation", Energy Policy, vol. 116, pp. 10-18, 2018.
7. P. Raña, P, J. Vilar, G. Aneiros, " On the Use of Functional Additive Models for Electricity Demand and Price Prediction" IEEE Access, vol. 6, pp. 9603–9613, 2018.
8. A. Kaur, L. Nonnenmacher, C.F.M. Coimbra, "Net load forecasting for high renewable energy penetration grids", Energy, vol. 114, pp. 1073–108, 2016.
9. A. Talhar, S. Bodkhe, V. Borghate, "Proposed Electricity Tariff Model for Residential Consumers in Maharashtra", IEEE International Conference on Power Electronics, Drives and Energy Systems (PEDES), Jaipur, India, 2020, pp. 1-6.
10. F. Yanine, A. Sánchez-Squella, A. Barrueto, A. Parejo, F. Cordova, and H. Rother, "Grid-tied distributed generation systems to sustain the smart grid transformation: Tariff analysis and generation sharing," Energies, vol. 13, no. 5, pp. 1187, 2020.
11. Qie Sun, Hailong Li, Zhanyu Ma, Chao Wang, Javier Campillo, Qi Zhang, Fredrik Wallin, Jun Guo, "A Comprehensive Review of Smart Energy Meters in Intelligent Energy Networks", IEEE Internet Of Things Journal, vol. 3, no. 4, pp.464-479, 2016.
12. C. Aswin Raj, E. Aravind, B. Ramya sundaram, Shriram K Vasudevan, "Smart Meter Based on Real Time Pricing", Procedia Technology, vol. 21, pp. 120-124, 2015.
13. Tobias Knayer, Natalia Kryvinska, "An analysis of smart meter technologies for efficient energy management in households and organizations", Energy Reports, vol.8, pp. 4022-4040, 2022.
14. Ali Parsa, Tooraj Abbasian Najafabadi, Farzad Rajaei Salmasi, "A Hierarchical Smart Home Control System for Improving Load Shedding and Energy Consumption: Design and Implementation", IEEE Sensors Journal, vol. 19, no. 9, pp. 3383-3390, 2019.
15. M. Usman Saleem, M. Rehan Usman, Mustafa Shakir, "Design, Implementation, and Deployment of an IoT Based Smart Energy Management System", IEEE Access, vol. 9, pp. 59649- 5966, 2021.
16. D. Marikyan, S. Papagiannidis and E. Alamanos, "A systematic review of the smart home literature: A user perspective", Technology Forecasting Social Change, vol. 138, pp. 139-154, 2019.
17. S. Madakam, R. Ramaswamy and S. Tripathi, "Internet of Things (IoT): A literature review", Journal Computer Communication, vol. 3, no. 5, pp. 164-173, 2015.
18. C. Zhi, W. Lei, and F. Yong, "Real-time price-based demand response management for residential appliances via stochastic optimization and robust optimization," IEEE Transactions on Smart Grid, vol. 3, no. 4, pp. 1822-1831, 2012.
19. M. Pipattanasomporn, M. Kuzlu, and S. Rahman, "An algorithm for intelligent home energy management and







**Krishnaveni et al.,**

demand response analysis," IEEE Transactions on Smart Grid, vol. 3, no. 4, pp. 2166-2173, 2012.

20. Nedim Tutkun, Alessandro Burgio, Michal Jasinski, Zbigniew Leonowicz, Elzbieta Jasinska, "Intelligent Scheduling of Smart Home Appliances Based on Demand Response Considering the Cost and Peak-to-Average Ratio in Residential Homes", Energies, vol.14, 8510, 2021

21. Pijush Kanti Dutta Pramanik, Nilanjan Sinhababu, Bulbul Mukherjee, Sanjeevikumar Padmanaban, Aranyak Maity, Bijoy Kumar Upadhyaya, Jens Bo Holm-Nielsen, Prasenjit Choudhury, "Power Consumption Analysis Measurement Management and Issues: A State-of-the-Art Review of Smartphone Battery and Energy Usage", IEEE Access, vol. 7, pp. 182113-182172, 2019.

22. Yepeng Ni, Fang Miao, Jianbo Liu, Jianping Chai. "Implementation of Wireless Gateway for Smart Home", Communications and Network, vol.11, pp. 16- 20, 2013.

23. S.D.T. Kelly, N.K. Suryadevara, S.C. Mukhopadhyay, "Towards the Implementation of IoT for Environmental Condition Monitoring in Homes", Sensors Journal, IEEE, Volume: 13, pp- 3846 –3853, 2013.

24. K. Gill, S.-H. Yang, F. Yao, and X. Lu, "A zigbee-based home automation system," IEEE Transactions on Consumer Electronics, vol. 55, no. 2, pp. 422–430, 2009.

**Table 1 List of Message Commands**

MESSAGE	OPERATION
#A.all on*	Turn on all
#A.all off*	Turn off all
#A.tv on*	Turn on the TV
#A.tv off*	Turn off the TV
#A.light off*	Turn off the light
#A.fan on*	Turn on the Fan
#A.fan off*	Turn off the Fan

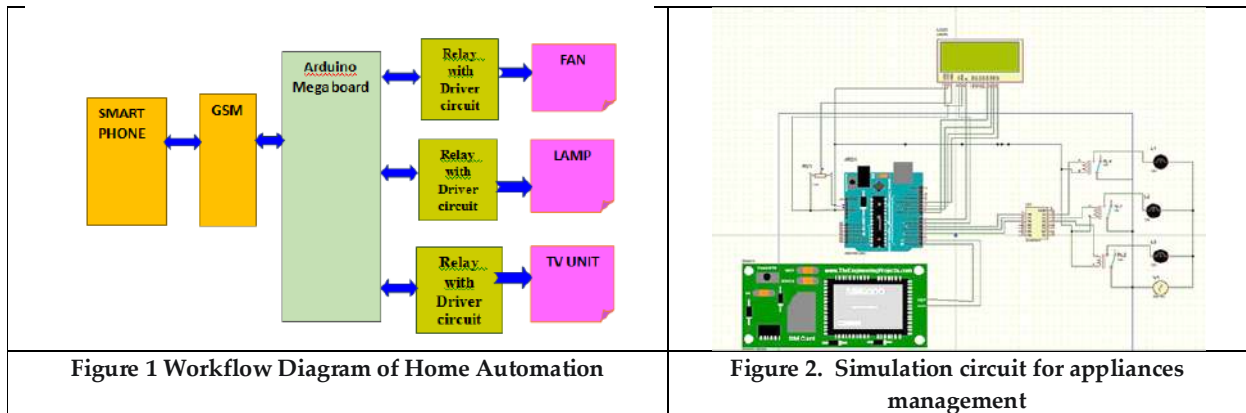
**Table 2. Description of hardware components**

Sl.NO	Component	SPECIFICATIONS
1.	Arduino UNO	<ul style="list-style-type: none"> <li>• A microcontroller board with an ATmega328P core.</li> <li>• Six analog inputs, fourteen digital input/output pins, a USB port an ICSP header, a power jack, a reset button and a 16 MHz ceramic resonator.</li> </ul>
2.	Relay driver ULN2003	<ul style="list-style-type: none"> <li>• This is an 8-channel relay interface board that is 5V active low relay module which is directly controlled by microcontrollers.</li> <li>• High-current equipment can be regulated.</li> <li>• Standard interface is linked to many Microcontrollers directly.</li> <li>• Maximum voltage for a relay output is AC-250V, 10A or DC-30V 10A.</li> </ul>
3.	GSM module Sim 900A	<ul style="list-style-type: none"> <li>• Customary AT instructions</li> <li>• Weight of item: 4.54 g</li> <li>• Serial baud rate adjustable can be adjusted from 1.2k to 115.2k BPS</li> <li>• electricity-less consumption mode: 1.5 mA of electricity is typically used in SLEEP mode.</li> <li>• Single supply voltage: 3.4V to 4.5V</li> </ul>





Krishnaveni et al.,





## Respiratory Muscle Training Protocols and Outcomes for Healthy Individuals: A Narrative Review

Jinal Parikh<sup>1\*</sup> and Megha Sheth<sup>2</sup>

<sup>1</sup>Assistant Professor, Department of Physiotherapy, Khyati Institute of Physiotherapy, (Affiliated to Gujarat University) Gujarat, India.

<sup>2</sup>Lecturer, Department of Physiotherapy, S.B.B. College of Physiotherapy, (Affiliated to Gujarat University) Gujarat, India.

Received: 13 Jan 2024

Revised: 09 Feb 2024

Accepted: 26 Apr 2024

### \*Address for Correspondence

**Jinal Parikh**

Assistant Professor,

Department of Physiotherapy,

Khyati Institute of Physiotherapy,

(Affiliated to Gujarat University) Gujarat, India.

Email: jinalparikh.phd@gmail.com



This is an Open Access Journal / article distributed under the terms of the **Creative Commons Attribution License** (CC BY-NC-ND 3.0) which permits unrestricted use, distribution, and reproduction in any medium, provided the original work is properly cited. All rights reserved.

### ABSTRACT

This clinical literature review presents the randomized controlled trial research studies about respiratory muscle strength training including inspiratory muscle strength training and expiratory muscle strength training in athletes and/or sports persons, singers, active and sedentary healthy individuals with its outcomes on bases of pre-designed training protocols through respiratory pressure threshold devices. Google Scholar, PubMed, and Science Direct databases were used to find the researches done on respiratory muscle strength training with the key words. Total of 11 published articles in the years ranged from **2012 to 2023** were selected which fulfilled the selection criteria for the current clinical review. Inspiratory Muscle Strength Training has been maximally studied as seen in 90.9% studies which showed significant improvement in pulmonary functions [Maximum Inspiratory Pressure and Maximum Expiratory Pressure] by respiratory muscle strength training. 54.5 % of studies done on Respiratory Muscle Strength Training have shown significant improvement in pulmonary function. Respiratory muscle strength training improves respiratory muscle strength in non diseased healthy individuals. Strength of recommendation is Grade A and level of evidence is 1 for this methodological study.

**Keywords:** Respiratory Muscle Strength Training (RMST), Inspiratory Muscle Strength Training (IMST), Expiratory Muscle Strength Training (EMST), Maximum Inspiratory Pressure (MIP), Maximum Expiratory Pressure (MEP), Healthy individuals





**Jinal Parikh and Megha Sheth**

## INTRODUCTION

Breathing being the primary vital function for every living individual, its fitness equally matters for any physically challenging activities of active life like athletics or sports, singing and task challenging occupational activities. To fulfill these tasks with best outcomes; it requires utmost physical fitness including respiratory fitness. Reduction or inappropriate respiratory muscle fitness according to demand of function may give difficulty in achieving functional goals[18]. Therefore, the fitness of respiratory muscles is much required to achieve desired goals and outcomes. Reduction or inappropriate respiratory muscle strength leads to respiratory muscle fatigue during activity performance; this can be explained by Metaboreflex. “Respiratory muscles fatigue resulting from accumulation of Lactic acid metabolites in respiratory muscles which activates Group III and IV nerve afferents of respiratory muscles; which increases sympathetic flow to exercising limb muscles from brain and reduces muscle function by limiting blood flow to the active muscles” which is known as Metaboreflex. Respiratory muscle fatigue increases the severity of exercise induced locomotor muscle fatigue causing reduced motor output to the working limb muscles and reduction in functional outcome. So as with Metaboreflex there is early termination of activity due to respiratory muscle fatigue.[12][19] RMST has been shown to reduce respiratory fatigue and it is used to improve performance in different sport and athletic competitions. [10][11]. Reduction in respiratory muscle contraction capacity leads to inability to produce normal respiratory pressure and air flow during inspiratory and expiratory phase of breathing thus compromises exercise performance in healthy individuals[6]. So as to prevent or treat the de-conditioning and/or reduction in respiratory muscle strength interventional training must be done.

There are two distinct forms of RMT available:

1. Based upon how the load is generated Resistance Training devices categorise in Respiratory Muscle/Strength Training [“High Force Low Velocity Respiratory Muscle Contractions”] also known as Inspiratory/flow Resistive Loading[IRL], Resistance Respiratory Muscle Training[RRMT] , Concurrent Inspiratory and Expiratory Training[CRMT], Expiratory Muscle Training[EMT].
2. Respiratory Muscle Endurance Training [“Low force high velocity contractions”] known as Ventilatory Muscle Training, Voluntary Isocapnic Hyperpnoea [VIH], Endurance Respiratory Muscle Training. [12].

**Respiratory muscle trainings can be done with various Training devices which include basic two types.**

1. a) Passive Flow-Resistance device – “Resistance or load to the respiratory flow is decided by previously selected variable orifice diameter; so smaller the diameter greater the resistance” B) Dynamically Adjusted Flow-Resistance device – “Continuous and dynamically adjusted resistance to respiratory flow by adjusting surface area of flow orifice according to respiratory flow rate” and C) Pressure Threshold device–“ To initiate respiration, threshold resistance must be overcome by producing Respiratory Mouth Pressure”
2. For Endurance Training device – This requires to maintain high level of ventilation atleast for upto 30 minutes, needing high commitment, motivation due to time consuming strenuous activity .[13]

The simple assessment of global respiratory muscle strength in a clinical setting to screen respiratory muscle weakness with Non invasive Voluntary/Volitional tests includes three main components 1) Maximal Static Inspiratory Mouth Pressure (P<sub>imax</sub> or MIP), 2) Maximal Static Expiratory Mouth Pressure (P<sub>Emax</sub> or MEP) and 3) Maximal Sniff Nasal Inspiratory Pressure (SNIP).(14) MicroRPM is a Respiratory pressure meter which is a reliable device getting used for non invasive assessment of respiratory pressure i.e. Maximum Inspiratory and Expiratory Pressure which reflects inspiratory and expiratory muscle strength respectively[5]. Every Physical training would require a well pre-designed training protocol. This provides a specific direction for training and probability of having better improvements in outcomes. Moreover the theoretical aspects, the protocols are mainly designed on the bases of significant responses gained from physiological systems outcomes and/or functional outcomes with training of the respiratory muscles and evidences collected over a period of time for specific population by scientific researches. Aim of this review is to collect scientific research literature available on web database regarding effect of RMST on



**Jinal Parikh and Megha Sheth**

inspiratory & expiratory muscle strength (i.e. MIP and MEP respectively) with given RMST protocols and outcomes derived through these protocols used in these researches. This can guide a researcher for further researches to design protocols for RMST over the targeted population; athletes or sports persons, singers, active healthy and sedentary individuals. Multiple researches have been done till time which has very wide range of a respiratory training protocols in terms of frequency, intensity and duration for children to geriatric populations and from most sedentary to highly active sports population. This will further help to look for finding any correlation of training frequency, intensity and duration with age, gender or specific population.

**METHOD**

For online medical research articles Google Scholar Database, PubMed, and Science Direct were used to find the researches done on RMST with the key words of 'Respiratory Muscle Strength Training'(RMST), 'Inspiratory Muscle Strength Training' (IMST), 'Expiratory Muscle Strength Training'(EMST), 'Maximum Inspiratory Pressure' (MIP), 'Maximum Expiratory Pressure'(MEP) with setting the time limit from 2012 to 2023. Figure1. Describes the procedure of selection of research articles for narration. Total 48 studies were found, out of which 11 studies were selected according to pre decided selection criteria and included for further narration.

**STUDY SELECTION CRITERIA****Research article inclusion criteria**

English language articles published during 2012 to 2023) Studies done with randomized control trial (RCT) of respiratory muscle strength training. 3) Athletes or sports persons, singers or other voice users, mouth music instrumentalist, active and sedentary healthy individuals. 4) Male and female from age group of children, adolescents, adults and elders 5) Having outcomes of respiratory strength i.e., MIP, and/or MEP 6) RMST done with Pressure Threshold Devices.

**Research article exclusion criteria**

RMST done on Pathological/Medical or Surgical conditions/Pathological Dysphonia. 2) MIP and MEP evaluated with invasive Non Volitional Test 3) Study with Respiratory Muscle Endurance Training 4) Respiratory Pressure Meter Device comparative study 5) RMST combined with other Training i.e. e.g RMET, Resistance Training, Aerobic Training. 6) Only abstract of study available. 7) Pilot study and Case Series. 8) Studies on physically or mentally disabled Population.

**RESULT AND DISCUSSION**

Table: 1 describes the salient characteristics of all the RCT studies selected for narration. The present review describes total 11 RCT. IMST being maximally studied 90.9% and only one EMST on healthy adult male has been done. There is no RCT study on combined IMST- EMST. RMST is being studied in wide age range of population i.e. 14 yrs old Swimmers to 80 yrs old Elders. Respiratory muscle strength training intensity is decided by percentage of respiratory pressure i.e. MIP and MEP; 30% to 80% Respiratory pressure have been used in different researches out of which 50 to 55% training intensities are being used commonly, 30 breaths per session, two sessions per day for 7 days per weeks, for 4 and 8 weeks training duration is most commonly used training protocols. With given protocols there is significant improvement in pulmonary functions [MIP and MEP] by RMST in 54.5 % of studies. Rests of the studies have shown significant improvement in respiratory pressure after training within the group (Pre-post evaluation) but no between the groups (i.e. compared with control group). No RCT of RMST is available for singer, musicians or other voice users.



**Jinal Parikh and Megha Sheth**

## DISCUSSION

This review is aimed at describing the RMST protocols and outcomes for healthy individuals [athletes or sports persons, singers, mouth music instrumentalists, active healthy and sedentary individuals, healthy smokers, ranging from children to geriatric population] with respiratory muscle training devices i.e. pressure threshold devices. Total of 11 RCT research articles on different healthy populations has been found except is for voice users [e.g. Speakers, Teachers, Vocalists or Singers] and Mouth Music Instrumentalist. Out of 11 six studies have shown Improvement in MIP and MEP by RMST. Remaining 5 studies have shown no improvement of MIP with RMST when compared with control group. Few studies have shown Improvement in MIP and MEP with IMST only this supports the literature expiratory muscles work during forced or loaded inspiratory phase of breathing<sup>[17]</sup>. This explains that only IMST is enough for both inspiratory and expiratory muscle strength and can be used alone clinically for training of both respiratory muscles. Though for the population who requires more of expiratory pressure like voice users and mouth music instrumentalist alone EMST or combined IMST and EMST can be done. None of the studies have seen any long term changes in MIP and MEP after cessation of respiratory training. RCT done by Helga et al (2014) has shown statistical improvement in MIP and MEP in elder with training intensity at 40% of MIP and 8 resisted breaths per day for 8 weeks which is conflicting results of study done by Francesco et al (2019) on older adults which showed no significant changes in MIP between experimental and control groups with 8 weeks of RMST with 50-80% training intensity. MIP and MEP at mouth level represents inspiratory and expiratory muscle strength respectively.

For the measurement of MIP and MEP at mouth level via non invasive methods MicroRPM is the device getting used most frequently. There is very wide variation in total study duration which ranges from 4 weeks minimally to 12 weeks maximally and showing significant changes in MIP and MEP with RMST, further studies are recommended to see the effect of training duration on MIP and MEP. There is a role of warm up sessions prior to physical training for better performances<sup>[8]</sup>, here none of the research article has mentioned any warm up sessions prior to respiratory muscle training so further studies regarding the effect of warm up session with RMST are needed. To understand the relation of training protocols with age, gender and population further studies are required as due to lack of RCT studies statistical correlation cannot be described There is no any kind of health hazards including any changes in vitals during the training sessions has been reported in any studies with use of pressure threshold devices. This supports the results gained by Helena et.al<sup>[16]</sup> stating that EMST don't fluctuate cardiovascular parameters in healthy young adults. Further precautions should be taken related to hygiene of training devices as its being used almost on daily bases so any respiratory infections can contaminate it very easily through multiple breathing efforts on devices and same hygiene precautions for assessment device as well as being used in multiple people. Further researches on training with lesser duration in term of total training weeks and frequency in term of session per week can be done to check effectiveness of RMST on pulmonary parameters. No RCT has been reported for Voice users, Dancers and Musicians; these can also be done in future. Further review for role of RMST on other pulmonary functions & task specific outcome measures in healthy individuals is needed.

## CONCLUSION

Respiratory Muscle Strength Training (RMST) significantly improves Respiratory Muscle Strength [MIP and MEP] in non diseased healthy individuals.

## ACKNOWLEDGMENT

None



**Jinal Parikh and Megha Sheth****REFERENCES**

1. Archiza B, Andaku DK, Caruso FCR, et al. Effects of inspiratory muscle training in professional women football players: a randomized sham-controlled trial. *Journal of Sports Sciences*. 2017;36(7):771-780. doi: <https://doi.org/10.1080/02640414.2017.1340659>
2. Bostanci vÖ, Mayda H, Yılmaz C, Kabadayı M, Yılmaz AK, Özdal M. Inspiratory muscle training improves pulmonary functions and respiratory muscle strength in healthy male smokers. *Respiratory Physiology & Neurobiology*. 2019;264:28-32. doi: <https://doi.org/10.1016/j.resp.2019.04.001>
3. Cunha M, Mendes F, Paciência I, et al. The effect of inspiratory muscle training on swimming performance, inspiratory muscle strength, lung function, and perceived breathlessness in elite swimmers. *Porto Biomedical Journal*. 2019;4(6):e49. doi: <https://doi.org/10.1097/j.pbj.0000000000000049>
4. De Sousa MM, Pimentel M dos S, Sobreira I de A, Barros R de J, Borghi-Silva A, Mazzoli-Rocha F. Inspiratory Muscle Training Improves Aerobic Capacity in Amateur Indoor Football Players. *International Journal of Sports Medicine*. 2020;42(05):456-463. doi: <https://doi.org/10.1055/a-1255-3256>
5. Dimitriadis Z, Kapreli E, Konstantinidou I, Oldham J, Strimpakos N. Test/Retest Reliability of Maximum Mouth Pressure Measurements With the MicroRPM in Healthy Volunteers. *Respiratory Care*. 2011;56(6):776-782. doi: <https://doi.org/10.4187/respcare.00783>
6. Edwards AM, Maguire GP, Graham D, Boland V, Richardson G. Four Weeks of Inspiratory Muscle Training Improves Self-Paced Walking Performance in Overweight and Obese Adults: A Randomised Controlled Trial. *Journal of Obesity*. 2012;2012:1-6. doi: <https://doi.org/10.1155/2012/918202>
7. Fatma AM, Hamada HA, Saab IM. Effect of inspiratory muscle training on diaphragm mobility and functional capacity in elderly: A randomized clinical trial. *Journal of Gerontology , series A. Biological science and Medical Sciences. Fizjoterapia Pol.* 2019;19(2):28-32 [https://www.researchgate.net/publication/368288830\\_Effect\\_of\\_Inspiratory\\_Muscle\\_Training\\_on\\_Diaphragm\\_Mobility\\_and\\_Functional\\_Capacity\\_in\\_Elderly\\_A\\_randomized\\_clinical\\_trial](https://www.researchgate.net/publication/368288830_Effect_of_Inspiratory_Muscle_Training_on_Diaphragm_Mobility_and_Functional_Capacity_in_Elderly_A_randomized_clinical_trial)
8. Fradkin AJ, Zazryn TR, Smoliga JM. Effects of Warming-up on Physical Performance: A Systematic Review With Meta-analysis. *Journal of Strength and Conditioning Research*. 2010;24(1):140-148. doi: <https://doi.org/10.1519/jsc.0b013e3181c643a0>
9. Ferraro FV, Gavin JP, Wainwright T, McConnell A. The effects of 8 weeks of inspiratory muscle training on the balance of healthy older adults: a randomized, double-blind, placebo-controlled study. *Physiological Reports*. 2019;7(9):e14076. doi: <https://doi.org/10.14814/phy2.14076>
10. Griffiths LA, McConnell AK. The influence of inspiratory and expiratory muscle training upon rowing performance. *European Journal of Applied Physiology*. 2006;99(5):457-466. doi: <https://doi.org/10.1007/s00421-006-0367-6>
11. Hartz CS, Sindorf MAG, Lopes CR, Batista J, Moreno MA. Effect of Inspiratory Muscle Training on Performance of Handball Athletes. *Journal of Human Kinetics*. 2018;63(1):43-51. doi: <https://doi.org/10.2478/hukin-2018-0005>
12. Illi SK, Held U, Frank I, Spengler CM. Effect of Respiratory Muscle Training on Exercise Performance in Healthy Individuals. *Sports Medicine*. 2012;42(8):707-724. doi: <https://doi.org/10.1007/bf03262290>
13. KKP M, LR N, PR A, JC P, LFT S. A Review on Respiratory Muscle Training Devices. *Journal of Pulmonary & Respiratory Medicine*. 2018;08(02). doi: <https://doi.org/10.4172/2161-105x.1000451>
14. Laveneziana P, Albuquerque A, Aliverti A, et al. ERS statement on respiratory muscle testing at rest and during exercise. *European Respiratory Journal*. 2019;53(6):1801214. doi: <https://doi.org/10.1183/13993003.01214-2018>
15. Lin CH, Lee CW, Huang CH. Inspiratory Muscle Training Improves Aerobic Fitness in Active Children. *International Journal of Environmental Research and Public Health*. 2022;19(22):14722. doi: <https://doi.org/10.3390/ijerph192214722>





**Jinal Parikh and Megha Sheth**

16. Laciuga H, Davenport P, Sapienza C. The Acute Effects of a Single Session of Expiratory Muscle Strength Training on Blood Pressure, Heart Rate, and Oxygen Saturation in Healthy Adults. *Frontiers in Physiology*. 2012;3. doi: <https://doi.org/10.3389/fphys.2012.00048>
17. Mackała K, Kurzaj M, Okrzymowska P, Stodółka J, Coh M, Rożek-Piechura K. The Effect of Respiratory Muscle Training on the Pulmonary Function, Lung Ventilation, and Endurance Performance of Young Soccer Players. *International Journal of Environmental Research and Public Health*. 2019;17(1):234. doi: <https://doi.org/10.3390/ijerph17010234>
18. Padkao T, Boonla O. Relationships between respiratory muscle strength, chest wall expansion, and functional capacity in healthy nonsmokers. *Journal of Exercise Rehabilitation*. 2020;16(2):189-196. doi: <https://doi.org/10.12965/jer.2040080.040>
19. Romer LM, Polkey MI. Exercise-induced respiratory muscle fatigue: implications for performance. *Journal of Applied Physiology*. 2008;104(3):879-888. doi:<https://doi.org/10.1152/jappphysiol.01157.2007>
20. Souza H, Rocha T, Pessoa M, et al. Effects of Inspiratory Muscle Training in Elderly Women on Respiratory Muscle Strength, Diaphragm Thickness and Mobility. *The Journals of Gerontology Series A: Biological Sciences and Medical Sciences*. 2014;69(12):1545-1553. doi: <https://doi.org/10.1093/gerona/glu182>
21. Shukla M, Prem V. *Journal of Cardiovascular Disease Research*. Respiratory muscle training on diaphragm thickness, pulmonary function test and respiratory muscle strength in healthy young adults: a randomized controlled trial. Accessed October 21, 2023. [https://www.jcdro nline.org/admin/Uploads/Files/624433a82a3387\\_34018566.pdf](https://www.jcdro nline.org/admin/Uploads/Files/624433a82a3387_34018566.pdf)
22. Tsukamoto T, Kato M, Kurita Y, Uchida M, Kubo A, Maruyama H. The Efficacy of Expiratory Muscle Training during Inspiratory Load in Healthy Adult Males: A Randomized Controlled Trial. *Healthcare*. 2022;10(5):933-933. doi: <https://doi.org/10.3390/healthcare10050933>

**Table:1 Study characteristics**

Sr.No	Author & Study Type	Training Type & Population	Baseline Training Intensity with Training Device	Breaths / session	Training session per day	Training Days In A Week	Total Duration (Week)	Result Of Study on MIP & MEP	Conclusion
1	Edwards et al. (2012) [6] A Randomized Controlled Trial	IMT; 15 Overweight and Obese Adults (40 to 65 yrs old Male and Female)	EG =55% MIP with POWER Breathe CG=10% MIP	30 Inspiration	Twice	7 days	4 Weeks	P value MIP EG = p < 0.05 within the group but not between the groups	IMT may improve MIP in Overweight and obese adults
2	Souza et al (2014) [20] Controlled, Randomized, &	IMT; 22 Elderly Women (60-80 Yrs)	EG = 40% MIP with Threshold IMT CG= NR	8 Breath series for 2 mins with 1 min rest	Twice	7 Days	8 Weeks	P Value MIP p < .001 for within and between	IMT protocol of moderate intensity produces an increase in







**Jinal Parikh and Megha Sheth**

	Double-blind Clinical Trial							groups	respiratory muscle strength
								P Value MEP p < .001 for within and p = .013 for between groups	
3	Archiza et al. (2017) <sup>[1]</sup>  A randomized double-blind sham-controlled trial	IMT;  18 female football players (20± 2 yrs)	EG = 55% MIP with POWERbreathe® K5,  CG = 15% MIP	30 Inspirations	Twice	5 days	6 Weeks	MIP P value Within the group p= 0.0001 for EG and CG. No significant changes in MEP	IMT may improve inspiratory muscles Strength female football players
4	Bostanci et al (2019) <sup>[2]</sup>  A randomized, double-blind, and placebo controlled Design	IMT;  42 Healthy male smokers [23 ± 6 yrs]	EG Smoker and EG Non Smoker = 50% MIP with POWER®Breath Classic  CG = 15% MIP	30 dynamic inspiratory efforts (with 1 min interval)	Twice	7 Days	4 Weeks	P value for MIP and MEP EG Smoker and EG Non Smoker = p< 0.05 for between and within the group  CG MEP p value = p< 0.05	significantly improvement observed, in expiratory muscle strength and pulmonary functions of the smoker than the non smoker group
5	Ferraro et	IMT;	EG= 50%	30	Twice	7 days	8	P value	IMT





**Jinal Parikh and Megha Sheth**

	all (2019) <sup>[9]</sup> Randomized, double-blind, placebo-controlled study	46 community-dwelling older adults [74± 6 years]	MIP with POWERbreathe Medic Plus CG= 15% MIP , 60 breaths once daily	Inspiration			Weeks	MIP within the group EG = P ≤ 0.01, CG = P = 0.02	improves MIP significantly within the group but not between the groups
6	Cunha et al. (2019) <sup>[3]</sup> A Randomized Controlled Trial	IMT; 32 Elite Swimmers (15 and 14 years old)	EG = 55% MIP with POWERbreathe Plus PB-2002 CG = 15% MIP	2 cycles of 30 Inspiration	NR	5 days	12 Weeks	MIP P value p=0.914 between the group p= 0.01 within the EG and p=0.036 for CG	No significant effects on inspiratory muscle strength of elite swimmers.
7	Fatma et al. (2019) <sup>[7]</sup> A randomized controlled trial	IMT; 48 male and female non smokers elders of 60 to 70 yrs	EG= 40% MIP With Threshold IMT (Respironics) CG= 7 CmH2o of equipment	8 cycles of 2 min Training with 1 min Break	NR	3 days	10 Weeks	MIP P value EG = p <0.0001 within the group and between the group CG = p< 0.838 within the group and P< 0.296 between the group	IMT improves Respiratory muscle strength in elders
8	De souza et al. (2020) <sup>[4]</sup> Controlled	IMT, 30 Male amateur school	EG with POWERbreathe International EG1= 80% of	EG1 = 3 sets of 12 Repetitions	Once	3 days	8 Weeks	P value within the EG1 , EG2 group.	IMT enhances MIP and MEP in football





**Jinal Parikh and Megha Sheth**

	, simple blind randomized clinical study	team of indoor football players 14 to 30 yrs old	MIP EG2= 50% of MIP CG = No training	EG2= 2 sets of 20 repetitions 2 min rest between sets				MIP p < 0.000, MEP P =0.003  No significant difference for changes of MIP and MEP between training groups	player
9	Shukla et al. (2021) [21] A randomized controlled trial	IMT 60 Young adult ( 22-23 yrs old)	EG =50% MIP and MEP with Power Lung CG = At base line without any load.	30 repetitions	Twice	5 days	8 weeks	P Value  MIP and MEP within and Between the group = P<0.0001	RMT increases MIP and MEP in young adults.
10	Lin et al. (2022) [15] A randomized controlled trial	IMT; 30 Active Children (age 10.0 ± 0.6 yrs)	EG High intensity = 80% of MIP EG Low intensity = 30% of MIP CG = No training	4 sets of 6 Inspiratory Breath	NR	5 days	6 weeks	MIP P value within group  EG1= p <0.05  EG2= p =0.19  CG = p =0.88  Between Group p =0.49	6 weeks of high-intensity IMT results in an increase in MIP, and low-intensity IMT does not result in any change in MIP.
11	Tsukamoto et al.	EMT;	EG = 50% MEP with	15 min	Twice	7 days	4 Weeks	P value	EMT increases

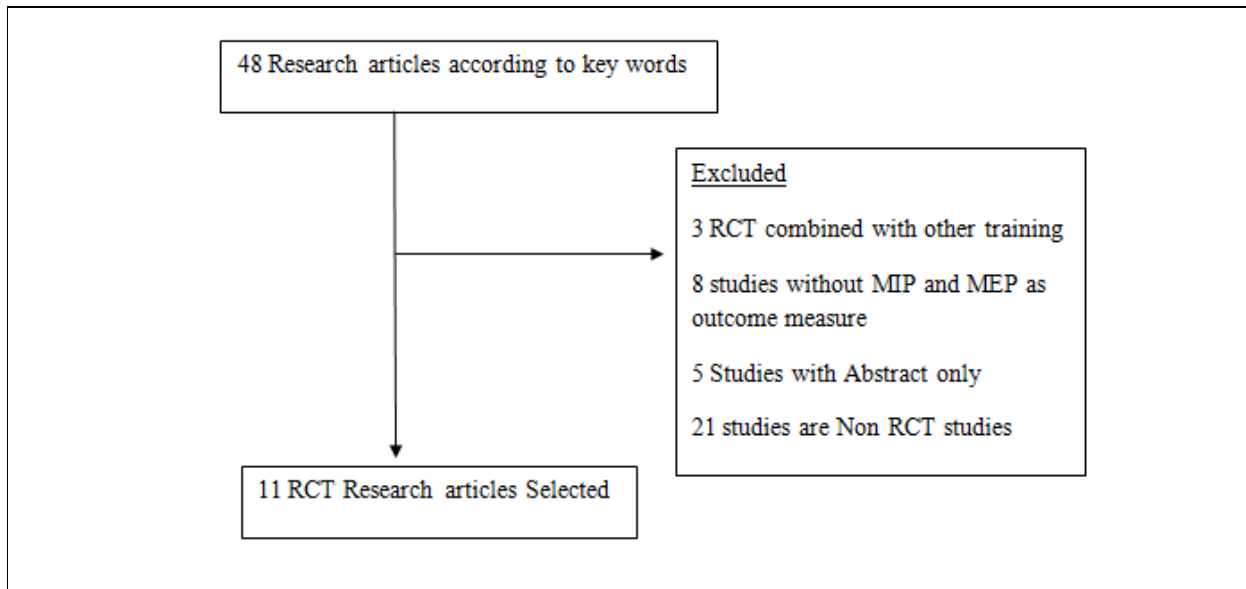




**Jinal Parikh and Megha Sheth**

	(2022) <sup>[22]</sup> A Randomized Controlled Trial	31 Healthy adult Male (20-39 yrs)	EMST150 CG= No training					EG MEP = p < 0.01 within the group MIP = p < 0.01 between group	PEmax reduces respiratory Muscle fatigue and respiratory distress.
--	---	-----------------------------------	----------------------------	--	--	--	--	--	--

(RMT= Respiratory Muscle Training, IMT= Inspiratory Muscle Training, EG = Experimental Group, CG = Control Group, EMST= Expiratory Muscle Strength Training, MIP = Maximum Inspiratory Pressure, MEP = Maximum Expiratory Pressure, PEP=Positive Expiratory Pressure, yrs= Age in Years, p = Probability of error, NR = Not reported)



**Figure 1. Flow diagram of studies selected for narration on bases of selection criteria.**





## The Impact of Unemployment on Drug Addiction in Tripura: An Empirical Investigation

Purna Laxmi Jamatia<sup>1\*</sup> and R. Gurumoorthy<sup>2</sup>

<sup>1</sup>Ph.D. Research scholar, Department of Sociology and Social work, Annamalai University, Chidambaram, Tamil Nadu, India.

<sup>2</sup>Associate Professor, Department of Sociology and Social work, Annamalai University, Chidambaram, Tamil Nadu, India.

Received: 22 Jan 2024

Revised: 09 Feb 2024

Accepted: 27 Apr 2024

### \*Address for Correspondence

**Purna Laxmi Jamatia**

Ph.D. Research scholar,

Department of Sociology and Social work,

Annamalai University,

Chidambaram, Tamil Nadu, India.

Email: purnajam25@gmail.com



This is an Open Access Journal / article distributed under the terms of the **Creative Commons Attribution License (CC BY-NC-ND 3.0)** which permits unrestricted use, distribution, and reproduction in any medium, provided the original work is properly cited. All rights reserved.

### ABSTRACT

Unemployment is a problem in itself and it causes number of issues for society. The present study highlights the pressing need to tackle drug addiction and unemployment in Tripura. The data were collected from a non-governmental organization called as 'Holy Welfare Society' It emphasizes the need for comprehensive interventions like as awareness campaigns, job creation, and strong government support for treatment and rehabilitation programs. Policymakers, medical experts, and community leaders working to address the interconnected issues of drug addiction and unemployment can benefit greatly from these findings. The researcher use self-report Interview Schedule and descriptive method were used for this study. The study shows that 90% of the unemployed were addicted to drugs such as marijuana, alcohol, heroin etc thus, proving that unemployment and drug addiction are interrelated.

**Keywords:** Unemployment, Drug, Addiction, Tripura, Rehabilitation

### INTRODUCTION

Unemployment is the major issue of the world. Contrary to popular belief, the term "unemployment" does not include people who have given up looking for work within the last four weeks for a variety of reasons, such as quitting to pursue further education, retiring, becoming disabled, or attending to personal matters. Instead, it refers to people who are waiting to return to work after being laid off. Unemployment can lead to various problems and be a hindrance to the society. Unemployment is also one of the main reasons for theft, drug addiction, and unnecessary



**Purna Laxmi Jamatia and R. Gurumoorthy**

violence etc. In today generation drug addiction has been common issue and these drugs are mostly used by unemployed youths of the society. This is mostly due to the availability of free time and unemployment. Tripura is one of the states of India where unemployment and drug addict youths are increasing rapidly. Despite the several steps taken by the government unemployment and drug addiction has shown no sign to reduce instead it is increasing every day. In-depth study is necessary in this topic to understand the root cause. There were several studies made on unemployment and drug addictions in Tripura but a study on a linkage between unemployment and drug addictions has not been conducted. As is well known, unemployment is at the core of all social and economic issues, and it also serves as a major contributing factor to the drug addiction of young people.

**UNDERSTANDING UNEMPLOYMENT AND DRUG ADDICTION****Unemployment**

A person who actively seeks employment but is unsuccessful is said to be unemployed. This is seen to be an important indicator of the state of the economy. The method most frequently used to determine a nation's unemployment rate is the unemployment rate itself. To obtain this information, one need only divide the total population of a country's labor force by the number of unemployed persons.

**Addiction**

The inability to give up a substance or habit, even when doing so could have negative psychological or bodily effects, is known as addiction. Addiction encompasses more than just a reliance on drugs like heroin or cocaine. A further symptom of several addictions is the unwillingness to give up engaging in certain activities, such as eating, working, or gambling. According to the American Society of Addiction Medicine, addiction is a medical condition that can be treated and is persistent. It involves intricate relationships between an individual's experiences, genetics, environment, and brain circuits. Addicts either use drugs or take part in obsessive actions that they frequently carry out despite negative consequences. Among all the addiction, drug addiction has been one of the common addictions all around the world. United Nation Office on Drugs and crime (UNODC) has mentioned on World Drug Report 2019 that 35 million people suffered from drug use disorder and only 1 in 7 received treatment. The increased understanding of the degree of drug use from surveys carried out in India and Nigeria – two of the world's ten most populated countries – has led to the higher estimations for 2017.

**Rehabilitation center**

Rehabilitative treatment aims to restore, maintain, or enhance the abilities necessary for day-to-day functioning. These skills could be mental, physical, or cognitive (learning and thinking). It is possible that you lost them because of an illness, an accident, or a side effect of medical care. Your functionality and everyday life may be enhanced with rehabilitation. Rehabilitation center can be of different types Cognitive rehabilitation, Physical therapy, Recreation therapy, Speech and Language therapy, occupational therapy, Vocational Rehabilitation etc. All the types of Rehabilitation have different functions.

**METHODOLOGY****OBJECTIVES**

- To Examine the inter-relation between unemployment and drug addiction in Tripura.
- To Understand the problems and challenges encountered by unemployed drug addict youths.

**Area of the study**

The study was conducted in De-addiction and rehabilitation center in Tripura namely `Holy Welfare Society`. It is a Non-Governmental Organization (NGO) located in the heart of Tripura in West district. The NGO was established on 11.06.2020. The organization has had around 380 patients approximately till date. It is one of the well-known organizations in the state and it is working conventionally for the welfare of the society.



**Purna Laxmi Jamatia and R. Gurumoorthy****Sample size**

The self-report interview schedules were used to gather data for this investigation. The total of 50 respondents were selected for the study. The age group of the respondents are between 15-30 which shows the respondents are all youths. There is no biases for the respondents.

**Limitation of the study**

- Study was limited to one non-governmental organization namely 'Holy Welfare Society' in Tripura.
- The present study was limited to 50 respondents.

**Methods and tools of data collection**

The study uses both qualitative and quantitative methods to gathered information. The primary source of information is collected from self-report interview schedule and the secondary source of information are gathered from document reports, books, Government reports, website, web information etc.

**DISCUSSION AND RESULTS**

The Table 1 shows age-wise composition of the respondents. Out of 50 respondents the majority 40% (20) of the respondents falls under the category of (20-24) years of age. The other 28% (14) of the respondents falls under the category of (25-30) years of age. 96% (48) of the respondents are male, while only 4% (2) of the respondents are women. This shows that male is more into drugs than women in the study area. Base of the table 3 - 80% (40) of the respondents are unemployed. Only 20% (10) of the respondents are employed in the study area.

**To Examine the inter-relation between unemployment and drug addiction in Tripura.**

68% (34) of the respondents are unemployed for more than 2 years. 20% (10) of the respondents are unemployed for 1-2 years, while 10% (5) of the respondents are unemployed for 6 months to 1 year and only 2% (1) of the respondents have unemployed for less than 6 months. The study explains that 100 % (50) of the respondents are using all types of drugs that is available in the market such as marijuana, heroin, injections etc. This shows that the usage of drugs is highly increasing day by day. The study further explains that the total of 100% (50) of the respondents are using drugs on a daily basis in the study area. This has affected the number of youths in the state and is a hindrance for the welfare of the society. As the number of usage of drugs is increasing day by day the table 7 show the main reason of drug addiction in the study area. 64% (32) of the respondents has agree that it is due to easy availability of drugs. 16% (8) of the respondents are because of unemployment, while 14% (7) of the respondents are due to the lack of education. Only 6% (3) of the respondents has mentioned other.

**To Understand the problems and challenges encountered by unemployed drug addict youths.**

The respondents have faced numerous problems physically and mentally. From the study it shows that majority of 94% (47) has sought help or treatment and only 6% (3) of the respondents did not seek help or treatment. 90% (45) of the respondents has had negative effects on health for taking drugs. The remaining only 10% (5) has claimed that drug addiction has affected their health positively. This shows that drug addiction is bad for our community as well as the individuals health. The study shows that 92% (46) of the respondents has witnessed the negative impact of drug addiction in the community while only 8% of the respondent did not witness any negative. The majority of the respondents has witnessed the negative impact of drug addiction in the community but that does not stop them from taking drugs. The study further explained that 86% (43) of the respondents said that in order to reduce drug addiction the government should provide access to treatment and rehabilitation program for all. 8% (4) of the respondents responded that the government should take initiatives to provide job to the youths and only 6% (3) of the respondents has said that the government should focus more on awareness campaigns and provide funding for it.



**Purna Laxmi Jamatia and R. Gurumoorthy****SUGGESTIONS**

The suggestions to reduce the drug addictions in the community and increase the employment opportunity for the welfare of the community are mentioned below

1. Job opportunities for the youths who have the qualification must be provided as joblessness create a sense of non-belongingness which ultimately pushes them towards drug addiction.
2. Proper awareness program or campaign should be made and it should start from family such as family council. Proper teaching to youths and family about disease cause by addiction.
3. Proper treatment for the patients is very important and the government should provide support in funding and medical bills.
4. There should be strong law enforcement against the drug dealers and users. It is high time that government take strong action and stop the availability of drugs in the community.
5. The Government should give more important to Rehabilitation centers because it is only in Rehab centers that the individual can remain clean.

**CONCLUSION**

Unemployment is often misunderstood, but it has effect on everything both on economic and social problem. A more advance system and effective strategies to be implemented by evaluating unemployment needs. Addiction in society must be stopped and in order to stop that all individuals need to take an active role for it. Individuals who suffer from addiction typically refuse that they have a problem and turn off getting help. An intervention might inspire someone to ask for or accept help by providing a structured chance for them to make adjustments before problems worsen. As from the study it is clear that a number of young people are involved in drug addiction in Tripura and it is important that government implement a strong policy such as awareness programs to reduce these problems of the state.

**REFERENCES**

1. Arkes, J. (2011). Recessions and the participation of youth in the selling and use of illicit drugs. *International Journal of Drug Policy*, 22(5), 335-340.
2. Bassols, N. M., & Castelló, J. V. (2016). Effects of the great recession on drug consumption in Spain. *Economics and Human Biology*, 22(2), 103-116.
3. Brenner, M. H. (1975). Mortality and the national economy. *The Lancet*, 26, 568-573.
4. Brenner, M. H. (1975). Trends in alcohol consumption and associated illnesses. Some effects of economic changes. *American Journal of Public Health*, 65, 1279-1292.
5. Brenner, M. H. (n.d.). Influence of social environment on psychopathology: The historic perspective. In J. E. Barret (Ed.), *Stress and mental disorder* (pp. 161-177). New York: Raven Press, 1979.
6. Bretteville-Jensen, A. L. (2011). Illegal drug use and the economic recession – what can we learn from the existing research? *International Journal of Drug Policy*, 22(5), 353-359.
7. Cahill, A. (2014). Almost 10% of Irish young people emigrated during recession. *Irish Examiner*, 29th March.
8. Callan, T., Nolan, B., Keane, C., Savage, M., & Walsh, J. (2013). The great recession, austerity and inequality: evidence from Ireland. *Intereconomics*, 48(6), 335-338.
9. Cambridge, G., Lynch, O., & Windle, J. (2022). *The Desistance Journey: Into Recovery and out of Chaos*. Palgrave McMillan, London.
10. Carew, A. M., & Comiskey, C. (2018). Rising incidence of ageing opioid users within the EU wide treatment demand indicator; the Irish opioid epidemic from 1996 to 2014. *Drug and Alcohol Dependence*, 192(2), 329-337.
11. Caulkins, J. P. (2011). The global recession's effect on drug demand – diluted by inertia. *International Journal of Drug Policy*, 22(5), 374-375.





**Purna Laxmi Jamatia and R. Gurumoorthy**

12. Central Statistics Office (CSO). (n.d.). Recorded crime offences by type of offence and year. Retrieved from <https://data.cso.ie/>.
13. Chalmers, J., & Ritter, A. (2011). The business cycle and drug use in Australia: evidence from repeated cross-sections of individual level data. *International Journal of Drug Policy*, 22(5), 341-352.
14. Clarke, V., & Braun, V. (2021). *Thematic Analysis: A Practical Guide*. Sage, London.
15. Claudy, M. C., Keating, A., & Prothero, A. (2017). Consumption. In W. K. Roche, P. J. O'Connell, & A. Prothero (Eds.), *Austerity and Recovery in Ireland: Europe's Poster Child and the Great Recession* (pp. 107-124). Oxford University Press, Oxford.
16. Colell, E., Sanchez-Niubo, A., Deldos, G. L., Benavides, F. G., & Domingo-Salvany, A. (2015). Economic crisis and changes in drug use in the Spanish economically-active population. *Addiction*, 110(7), 1129-1137.
17. Coulthard, M., Farrell, M., Singleton, N., & Meltzer, H. (2002). *Tobacco, alcohol and drug use and mental health*. London: Office of National Statistics ONS.
18. Forcier, M. W. (1988). Unemployment and alcohol abuse: a review. *Journal of Occupational Medicine*, 30, 246-251.
19. Hanisch, K. A. (1999). Job loss and unemployment research from 1994 to 1998: A review and recommendations for research and intervention. *Journal of Vocational Behavior*, 55(2), 188-220.
20. Healy, T. (2015). Emigration has taken its toll. Retrieved from [www.nerinstitute.net/blog/monday-blog-emigration-has-taken-its-toll](http://www.nerinstitute.net/blog/monday-blog-emigration-has-taken-its-toll).
21. Henkel, D. (1998). Sucht und Armut. Alkohol, Tabak und illegale Drogen [Addiction and poverty. Alcohol, tobacco and illicit drugs]. Opladen, Leske und Budrich.
22. Henkel, D. (2011). Unemployment and substance use: a review of the literature (1990-2010). *Current Drug Abuse Reviews*, 4(1), 4-27.
23. IPSOS. (2015). Prevalence of drug use and gambling in Ireland and drug use in Northern Ireland. Retrieved from [www.drugsandalcohol.ie/26364/1/Bulletin-1.pdf](http://www.drugsandalcohol.ie/26364/1/Bulletin-1.pdf).
24. Jamatia, P. L., & Gurumoorthy, R. (2023). An Exploratory Study on the Youth Unemployment in North-East India. *International Journal of Economic, Business, Accounting, Agriculture Management and Sharia Administration (IJEBAAS)*, 3(1), 85-92.
25. Kestila, L., Martelin, T., Rahkonen, O., Joutsenniemi, K., Pirkola, S., Poikolainen, K., Koskinen, S. (2008). Childhood and current determinants of heavy drinking in early adulthood. *Alcohol and Alcoholism*, 43, 460-469.
26. Khlaf, M., Sermet, C., & Le Pape, A. (2004). Increased prevalence of depression, smoking, heavy drinking and use of psycho-active drugs among unemployed men in France. *European Journal of Epidemiology*, 19, 445-451.
27. Nair, S. (2020). A Study on The Causes and Impact of Unemployment in India. *International Review of Business and Economics*, 4(2), 53.
28. Singh, L. B. (2006). *The Scourge of Unemployment in India and Psychological Health*. Concept Publishing Company.
29. Stewart, C. D. (1950). The Definition of Unemployment. *The Review of Economics and Statistics*, 32(1), 55-59.
30. Tsai, J., Ford, E. S., Li, C., Pearson, W. S., & Zhao, G. (2010). Binge drinking and suboptimal self-related health among adult drinkers. *Alcoholism: Clinical and Experimental Research*, 34, 1465-1471.
31. United Nations. (2005). *Figures of World Population Prospects: 2008 revision*. Geneva: UN Population Division.
32. United Nations World Youth Reports. (2013, 2016).
33. Winton, M., Heather, N., & Robertson, I. (1986). Effects of unemployment on drinking behavior: a review of the relevant evidence. *International Journal of Addiction*.





**Purna Laxmi Jamatia and R. Gurumoorthy**

**Table 1: Age-wise composition of the respondents**

SL No	Age Group	Frequency	In %
1	15-19 years	16	32.00%
2	20-24 years	20	40.00%
3	25-30 years	14	28.00%
	Total	50	100.00%

**Table 2: Gender of the respondents**

SL No	Gender	Frequency	In%
1	Male	48	96.00%
2	Female	2	4.00%
	Total	50	100%

**Table 3: Occupation status of the respondents**

SL No	Occupation	Frequency	In %
1	Employed	5	10.00%
2	Unemployed	40	90.00%
	Total	50	100.00%

**Table 4: Period of Unemployment**

SL No	Period of Unemployment	Frequency	In %
1	Less than 6 months	1	2.00%
2	6 months-1 year	5	10.00%
3	1 year-2 year	10	20.00%
4	More than 2 years	34	68.00%
	Total	50	100.00%

**Table 5: Types of drugs use**

SL No	Usage of drugs/ heroine/marijuana etc	Frequency	In %
1	Heroin	0	0.00%
2	Marijuana	0	0.00%
3	dendrite	0	0.00%
4	Alcohol	0	
5	All the above	50	100.00%

**Table 6 : Number of usage of drugs**

SL No	No of usage	Frequency	In %
1	Daily	50	100.00%
2	Few times a week	0	0.00%
3	Few times a month	0	0.00%
4	rarely	0	0.00%
	Total	50	100.00%

**Table 7: Reason of drug addiction**

SL No	Reasons of drug addiction	Frequency	In %
1	Unemployment	8	16.00%
2	Peer Pressure	0	0.00%
3	Lack of Education	7	14.00%





**Purna Laxmi Jamatia and R. Gurumoorthy**

4	Easy availability of Drugs	32	64.00%
5	Other	3	6.00%
	Total	50	100.00%

**Table 8: Sought help or treatment**

SL No	Sought help or treatment	Frequency	In %
1	Yes	47	94.00%
2	No	3	6.00%
	Total	50	100.00%

**Table 9: Affects of drug addiction on health**

SL No	Affects of drug addiction on health	Frequency	In %
1	Negatively	45	90.00%
2	Positively	5	10.00%
3	No Effect	0	0.00%
	Total	50	100.00%

**Table 10 : Witnessed negative impact of drug addiction in the community.**

SL No	Witnessed negative impact of drug addiction	Frequency	In %
1	Yes	46	92.00%
2	No	4	8.00%
	Total	50	100.00%

**Table 11: Role of Government**

SL No	Role of Government	Frequency	In %
1	Job Creation initiatives	4	8.00%
2	Providing access to treatment and Rehabilitation program	41	82.00%
3	Funding for awareness campaigns	3	6.00%
4	Strengthening law enforcement	2	4.00%
5	Other		0.00%
	Total	50	100.00%





## Finite L-Ideal Automaton and Finite R-Ideal Automaton of a Finite Ring Automaton

Y. Immanuel Nelson<sup>1\*</sup> and K. Muthukumaran<sup>2</sup>

<sup>1</sup>Research Scholar, P.G. and Research Department of Mathematics, Saraswathi Narayanan College (Autonomous), Perungudi, (Affiliated to Madurai Kamaraj University), Madurai, Tamil Nadu, India.

<sup>2</sup>Head and Associate Professor, P.G. and Research Department of Mathematics, Saraswathi Narayanan College (Autonomous), Perungudi, (Affiliated to Madurai Kamaraj University) Madurai, Tamil Nadu, India.

Received: 19 Jan 2024

Revised: 09 Feb 2024

Accepted: 26 Apr 2024

### \*Address for Correspondence

**Y. Immanuel Nelson**

Research Scholar,

P.G. and Research Department of Mathematics,

Saraswathi Narayanan College (Autonomous),

Perungudi, (Affiliated to Madurai Kamaraj University),

Madurai, Tamil Nadu, India.

Email: sharonroja.nelson@gmail.com



This is an Open Access Journal / article distributed under the terms of the **Creative Commons Attribution License** (CC BY-NC-ND 3.0) which permits unrestricted use, distribution, and reproduction in any medium, provided the original work is properly cited. All rights reserved.

### ABSTRACT

In this paper, the finite L-ideal automaton and finite R-ideal automaton of a finite ring automaton are defined and examples are given. Also, we proved that the intersection of two finite L-ideal automaton and two finite R-ideal automaton are again a finite L-Ideal Automaton and finite R-ideal automaton respectively and the union need not to be.

**Keywords:** Finite Automaton, Finite Ring Automaton, Finite Ideal Automaton, Finite L - Ideal Automaton, Finite R - Ideal Automaton.

### INTRODUCTION

The Automaton is a type of mathematical system model. The machine that responds to input by producing outputs is known as an automaton. For example, imagine that we give some data to the machine then the input and previous inputs made to the machine have an impact on the answer. Numerous different conceivable histories for the machine exist. It will, however, require an endless storage capacity. Since it is challenging to design machines with infinite storing capacity, we will focus on those whose past actions can only have a limited number of effects on their present actions. Because of this, we only take into account finite automata. Finite subgroup automata [4] and Finite abelian automata [6] were first introduced by K. Muthukumaran and S. Shanmugavadivoo respectively. M. Kamaraj and S.





**Immanuel Nelson and Muthukumar**

Shanmugavadivoo were also introduced finite binary automata [5]. Additionally, we presented Finite ring automata [2], Homomorphic images of finite ring automata[3], and Group actions in finite group automata[1]. In this study, Finite L-Ideal Automaton and Finite R-Ideal Automaton are introduced, and a few theorems are derived.

**PRELIMINARIES**

**Definition 2.1** The 5-tuple  $(Q, \Sigma, \delta, q_0, F)$  represents a finite automaton.  $Q$  is a finite set of components,  $q_0$  in  $Q$  is the beginning state,  $\Sigma$  is a finite input alphabet,  $F \subseteq Q$  is the set of ending states, and  $\delta$  is the transition rule which assigns every element of  $Q \times \Sigma$  to  $Q$ .

**Definition 2.2** [5] The 6-tuple  $(Q, *, \Sigma, \delta, q_0, F)$ , represents a finite binary automaton, where  $Q$  is a finite set of components called states,  $\Sigma$  is a finite set of integers,  $*$  is a mapping from  $Q \times Q$  to  $Q$ ,  $q_0$  in  $Q$  is a state called the beginning state and  $F \subseteq Q$  and  $F$  is the set of states called ending states and  $\delta$  is the transition rule which assigns every element of  $Q \times \Sigma$  to  $Q$  defined by the operation in the group  $(Q, *)$ , for example  $\delta(q, n) = q^n$ . The transition function  $\delta$  is extended in the manner shown below, if  $\Sigma^*$  is the set of input strings: For  $m \in \Sigma^*$  and  $n \in \Sigma$ ,  $\delta': Q \times \Sigma^* \rightarrow Q$  is defined by  $\delta'(q, mn) = \delta(\delta'(q, m), n)$ . If there is no ambiguity  $\delta'$  can be changed to  $\delta$ .

**Definition 2.3** [4] The 6-tuple  $(Q, *, \Sigma, \delta, q_0, F)$  represents a finite group automaton, where  $Q$  is a finite set of components and the components are called states and  $(Q, *)$  is a group,  $q_0 \in Q$  and the state  $q_0$  is called the beginning state,  $\Sigma$  is a subset of integers and the integers are called inputs,  $F \subseteq Q$  and the states (components) of  $F$  are called ending states,  $\delta$  is the transition rule which assigns every element of  $Q \times \Sigma$  to  $Q$  defined by the operation in the group  $(Q, *)$ .

**For example**  $\delta(q, n) = q * q * q * \dots * q$  (n times).

The transition function  $\delta$  is extended in the manner shown below, if  $\Sigma^*$  is the set of input strings:

For  $m \in \Sigma^*$  and  $n \in \Sigma$ ,  $\delta': Q \times \Sigma^* \rightarrow Q$  is defined by  $\delta'(q, mn) = \delta(\delta'(q, m), n)$ .

**Definition 2.4** [1] The 6-tuple  $(Q, *, \Sigma, \delta, q_0, F)$  represents a finite L – group automaton, where  $Q$  is a finite set of components, the components of  $Q$  are called states and  $(Q, *)$  is a group,  $q_0 \in Q$  and  $q_0$  is called the beginning state,  $\Sigma$  is a subgroup of  $G$  and the elements of  $\Sigma$  are called inputs,  $F \subseteq Q$  and the elements of  $F$  are called ending states,  $\delta: Q \times \Sigma \rightarrow Q$  is defined by  $\delta(q, n) = n * q$

**Definition 2.5** [1] The 6-tuple  $(Q, *, \Sigma, \delta, q_0, F)$  represents a finite R – group automaton, where  $Q$  is a finite set of components, the components of  $Q$  are called states and  $(Q, *)$  is a group,  $q_0 \in Q$  and  $q_0$  is called the beginning state,  $\Sigma$  is a subgroup of  $G$  and the elements of  $\Sigma$  are called inputs,  $F \subseteq Q$  and the elements of  $F$  are called ending states,  $\delta: Q \times \Sigma \rightarrow Q$  is defined by  $\delta(q, n) = q * n$

**Definition 2.6** [2] The 8-tuple  $(Q, +, \cdot, \Sigma, \delta_1, \delta_2, q_0, F)$  represents finite ring automaton, where  $Q$  is a finite set of components called states and  $(Q, +, \cdot)$  is a ring,  $q_0$  in  $Q$  is a state called the beginning state,  $\Sigma$  is a finite set of integers, and  $F \subseteq Q$  and  $F$  is the set of states called ending states and  $\delta_1, \delta_2$  are transition functions from  $Q \times \Sigma$  to  $Q$  defined by  $\delta_1(q, n) = nq$  and  $\delta_2(q, n) = q^n$

The transition function  $\delta$  is extended in the manner shown below, if  $\Sigma^*$  is the set of input strings:

For  $m \in \Sigma^*$  and  $n \in \Sigma$ ,  $\delta_1': Q \times \Sigma^* \rightarrow Q$  is defined by  $\delta_1'(q, mn) = \delta_1(\delta_1'(q, m), n)$ .  $\delta_1'$  can be changed to  $\delta_1$  to decrease the amount of notations.

For  $m \in \Sigma^*$  and  $n \in \Sigma$ ,  $\delta_2': Q \times \Sigma^* \rightarrow Q$  is defined by  $\delta_2'(q, mn) = \delta_2(\delta_2'(q, m), n)$ .  $\delta_2'$  can be changed to  $\delta_2$  to decrease the amount of notations.

The simple expression of a Finite Ring Automaton is FRA..





**Immanuel Nelson and Muthukumaran**

**Definition 2.7** Let  $(R, +, \cdot, \Sigma, \delta_1, \delta_2, q_0, F)$  be a FRA. Let  $S$  be a sub ring of  $R$ . Let us take  $\Sigma = S$ . Let  $q_0$  in  $R$  be a state called the beginning state and  $F \subseteq R$  and  $F$  is the set of states called ending states  $\delta_1, \delta_2$  are the mappings defined as follows:

Define  $\delta_1 : R \times \Sigma \rightarrow R$  by  $\delta_1(q, n) = n + q$

Define  $\delta_2 : R \times \Sigma \rightarrow R$  by  $\delta_2(q, n) = n \cdot q$

Then the ring automaton  $(R, +, \cdot, \Sigma, \delta_1, \delta_2, q_0, F)$  is called Finite L-Ring Automaton.

**Definition 2.8** Let  $(R, +, \cdot, \Sigma, \delta_1, \delta_2, q_0, F)$  be a FRA. Let  $S$  be a sub ring of  $R$ . Let us take  $\Sigma = S$ . Let  $q_0$  in  $R$  be a state called the beginning state and  $F \subseteq R$  and  $F$  is the set of states called ending states  $\delta_1, \delta_2$  are the mappings defined as follows:

Define  $\delta_1 : R \times \Sigma \rightarrow R$  by  $\delta_1(q, n) = n + q$

Define  $\delta_2 : R \times \Sigma \rightarrow R$  by  $\delta_2(q, n) = q \cdot n$

Then the ring automaton  $(R, +, \cdot, \Sigma, \delta_1, \delta_2, q_0, F)$  is called Finite R-Ring Automaton.

**FINITE L-IDEAL AUTOMATON AND FINITE R-IDEAL AUTOMATON**

**Definition 3.1** Finite L-Ideal Automaton

Let  $(R, +, \cdot, \Sigma, \delta_1, \delta_2, q_0, F)$  be a FRA. Let  $B$  be a non-empty subset of  $R$  such that  $b_1 - b_2 \in B$ , for all  $b_1, b_2 \in B$  and  $r \cdot b \in B$ , for all  $r \in R$  and for all  $b \in B$ . Then  $(B, +, \cdot, \Sigma, D_1, D_2, q_B, F_B)$  is a FRA, where  $+$  and  $\cdot$  are the operations of the ring  $(R, +, \cdot)$ ,  $\Sigma$  is the set of inputs as in the given automaton  $(R, +, \cdot, \Sigma, \delta_1, \delta_2, q_0, F)$ ,  $D_1$  maps  $B \times \Sigma$  into  $B$  such that  $\delta_1$  restricted to  $B$  is  $D_1$  and  $D_2$  maps  $B \times \Sigma$  into  $B$  such that  $\delta_2$  restricted to  $q_0$  if  $q_0 \in B$  or  $q_B = \delta_1(q_0, a) \in B$  or  $q_B = \delta_2(q_0, a) \in B$ , for some  $a \in \Sigma$  and  $F_B = F \cap B$ . The FRA  $(B, +, \cdot, \Sigma, D_1, D_2, q_B, F_B)$  is called a Finite L-Ideal Automaton of the given FRA  $(R, +, \cdot, \Sigma, \delta_1, \delta_2, q_0, F)$ .

**Definition 3.2:** Finite R-Ideal Automaton

Let  $(R, +, \cdot, \Sigma, \delta_1, \delta_2, q_0, F)$  be a FRA. Let  $B$  be a non-empty subset of  $R$  such that  $b_1 - b_2 \in B$ , for all  $b_1, b_2 \in B$  and  $b \cdot r \in B$ , for all  $r \in R$  and for all  $b \in B$ . Then  $(B, +, \cdot, \Sigma, D_1, D_2, q_B, F_B)$  is a FRA, where  $+$  and  $\cdot$  are the operations of the ring  $(R, +, \cdot)$ ,  $\Sigma$  is the set of inputs as in the given automaton  $(R, +, \cdot, \Sigma, \delta_1, \delta_2, q_0, F)$ ,  $D_1 : B \times \Sigma \rightarrow B$  such that  $\delta_1$  restricted to  $B$  is  $D_1$  and  $D_2 : B \times \Sigma \rightarrow B$  such that  $\delta_2$  restricted to  $B$  is  $D_2$ ,  $q_B = q_0$  if  $q_0 \in B$  or  $q_B = \delta_1(q_0, a) \in B$  or  $q_B = \delta_2(q_0, a) \in B$ , for some  $a \in \Sigma$  and  $F_B = F \cap B$ . The FRA  $(B, +, \cdot, \Sigma, D_1, D_2, q_B, F_B)$  is called Finite R-Ideal Automaton of the given automaton  $(R, +, \cdot, \Sigma, \delta_1, \delta_2, q_0, F)$ .

**Example 3.3** Let  $(L, \oplus, \odot, \Sigma, \tau_1, \tau_2, l_0, F)$ , be a FRA, where  $L = Z_6$ ,  $\Sigma = \{0, 2, 4\}$ ,  $\tau_1$  and  $\tau_2$  are the transition functions,  $l_0$  be the initial state. Let  $I = \{0, 2, 4\}$  be a subring of  $L$  under the binary operations in  $L$ , then  $(I, \oplus, \odot, \Sigma, \eta_1, \eta_2, i_0, F_i)$  where  $\eta_1$  maps  $I \times \Sigma$  into  $I$  and  $\eta_2$  maps  $I \times \Sigma$  into  $I$ . Let  $i_0 = 0$  be initial state, then we can select  $i_0 = 0$  also or  $\eta_1(l_0, a) \in I$  or  $\eta_2(l_0, a) \in I$  for some  $a \in \Sigma$  and  $F_i = F \cap I$ . Then the FRA  $(I, \oplus, \odot, \Sigma, \eta_1, \eta_2, i_0, F_i)$  is a Finite L-Ideal Automaton of the given FRA  $(L, \oplus, \odot, \Sigma, \tau_1, \tau_2, l_0, F)$ .

**Note 3.4:** There can be many number of Finite L-Ideal Automata and Finite R-Ideal Automata for the given FRA.

**Theorem 3.5** Let  $(R, +, \cdot, \Sigma, \delta_1, \delta_2, q_0, F)$  be a FRA. Let  $(B, +, \cdot, \Sigma, D_1, D_2, q_B, F_B)$  and  $(C, +, \cdot, \Sigma, D_1', D_2', q_C, F_C)$  be two Finite L-Ideal Automata of the FRA  $(R, +, \cdot, \Sigma, \delta_1, \delta_2, q_0, F)$ . Suppose there exists some  $a \in \Sigma$  such that  $\delta_1(q_0, a) \in B \cap C$  or  $\delta_2(q_0, a) \in B \cap C$ . Then there exists a Finite L-Ideal Automaton of the FRA  $(R, +, \cdot, \Sigma, \delta_1, \delta_2, q_0, F)$  with  $B \cap C$  as the set of all states for this Finite L-Ideal Automaton.

**Proof:** Consider the FRA  $(R, +, \cdot, \Sigma, \delta_1, \delta_2, q_0, F)$ .

Since  $(B, +, \cdot, \Sigma, D_1, D_2, q_B, F_B)$  is a Finite L-Ideal Automaton of the FRA  $(R, +, \cdot, \Sigma, \delta_1, \delta_2, q_0, F)$ ,  $D_1 : B \times \Sigma \rightarrow B$  and  $\delta_1$  restricted to  $B$  is  $D_1$  and  $D_2 : B \times \Sigma \rightarrow B$  and  $\delta_2$  restricted to  $B$  is  $D_2$





**Immanuel Nelson and Muthukumar**

Since  $(C, +, \cdot, \Sigma, D_1', D_2', q_C, F_C)$  is a Finite L-Ideal Automaton of the FRA  $(R, +, \cdot, \Sigma, \delta_1, \delta_2, q_0, F)$ ,  $D_1' : C \times \Sigma \rightarrow C$  and  $\delta_1$  restricted to  $C$  is  $D_1'$  and  $D_2' : C \times \Sigma \rightarrow C$  and  $\delta_2$  restricted to  $C$  is  $D_2'$ .

Let  $E = B \cap C$

Since  $(B, +, \cdot, \Sigma, D_1, D_2, q_B, F_B)$  and  $(C, +, \cdot, \Sigma, D_1', D_2', q_C, F_C)$  are Finite L-Ideal Automata of the FRA  $(R, +, \cdot, \Sigma, \delta_1, \delta_2, q_0, F)$ ,  $a - b \in B$ , for all  $a, b \in B$  and  $r \cdot a \in B$ , for all  $r \in R$  and for all  $a \in B$  and  $a - b \in C$ , for all  $a, b \in C$  and  $r \cdot a \in C$ , for all  $r \in R$  and for all  $a \in C$

Therefore,  $a - b \in E$ , for all  $a, b \in E$  and  $r \cdot a \in E$ , for all  $r \in R$  and for all  $a \in E$

Clearly  $(E, +, \cdot)$  is a ring which is a subring of  $(R, +, \cdot)$

Let us define the transition mappings  $\sigma$  and  $\sigma'$  as given below:

Define  $\sigma : E \times \Sigma \rightarrow E$  by  $\sigma(r, a) = D_1(r, a)$  or  $\sigma(r, a) = D_1'(r, a)$

(Since  $\delta_1$  restricted to  $B$  is  $D_1$  and  $\delta_1$  restricted to  $C$  is  $D_1'$ )

Therefore,  $\delta_1$  restricted to  $E$  is  $\sigma$

Define  $\sigma' : E \times \Sigma \rightarrow E$  by  $\sigma'(r, a) = D_2(r, a)$  or  $\sigma'(r, a) = D_2'(r, a)$

(Since  $\delta_2$  restricted to  $B$  is  $D_2$  and  $\delta_2$  restricted to  $C$  is  $D_2'$ )

Therefore,  $\delta_2$  restricted to  $E$  is  $\sigma'$

Let  $F_E = F_B \cap F_C$

Let  $q_E = q_0$  if  $q_0 \in E$  or

$$= \delta_1(q_0, a) \in E \text{ or } \delta_2(q_0, a) \in E, \text{ for some } a \in \Sigma$$

By the hypothesis,  $\delta_1(q_0, a) \in E$  or  $\delta_2(q_0, a) \in E$ , for some  $a \in \Sigma$ .

Hence,  $(E, +, \cdot, \Sigma, \sigma, \sigma', q_E, F_E)$  is a Finite L-Ideal Automata of the FRA  $(R, +, \cdot, \Sigma, \delta_1, \delta_2, q_0, F)$  with  $E = B \cap C$  as the set of all states for this Finite L-Ideal Automaton.

**Corollary 3.6** Let  $(R, +, \cdot, \Sigma, \delta_1, \delta_2, q_0, F)$  be a FRA. Let  $B_1, B_2, B_3, \dots, B_n$  be Finite L-Ideal Automata of the FRA  $(R, +, \cdot, \Sigma, \delta_1, \delta_2, q_0, F)$ . Suppose there exists  $a \in \Sigma$  such that  $\delta_1(q_0, a) \in B_1 \cap B_2 \cap B_3 \cap \dots \cap B_n$  or  $\delta_2(q_0, a) \in B_1 \cap B_2 \cap B_3 \cap \dots \cap B_n$ . Then there exists a Finite L-Ideal Automaton of the FRA  $(R, +, \cdot, \Sigma, \delta_1, \delta_2, q_0, F)$  with  $B_1 \cap B_2 \cap B_3 \cap \dots \cap B_n$  as the set of all states for this Finite L-Ideal Automaton.

**Proof:** Using the above theorem, it may be demonstrated by induction on  $n$ .

**Result 3.7** Union of two finite L-ideal automaton need not to be a finite L-ideal automaton.

**Proof:** Let  $(L, +, \cdot, \Sigma, \tau_1, \tau_2, l_0, F)$  be a FRA. Let  $(L_1, +, \cdot, \Sigma, \eta_1, \eta_2, l_0, F_{l_1})$  and  $(L_2, +, \cdot, \Sigma, \eta_1, \eta_2, l_0, F_{l_2})$  be two finite L-ideal automata of  $(L, +, \cdot, \Sigma, \tau_1, \tau_2, l_0, F)$ . Since union of two sub rings need not to be a subring, so  $L_1 \cup L_2$  need not to be a subring. Hence it is not possible to have the finite L-ideal automata with  $L_1 \cup L_2$  as the set of all states.

**Theorem 3.8** Let  $(R, +, \cdot, \Sigma, \delta_1, \delta_2, q_0, F)$  be a FRA. Let  $(B, +, \cdot, \Sigma, D_1, D_2, q_B, F_B)$  and  $(C, +, \cdot, \Sigma, D_1', D_2', q_C, F_C)$  be two Finite R-Ideal Automata of the FRA  $(R, +, \cdot, \Sigma, \delta_1, \delta_2, q_0, F)$ . Suppose there exists some  $a \in \Sigma$  such that  $\delta_1(q_0, a) \in B \cap C$  or  $\delta_2(q_0, a) \in B \cap C$ . Then there exists a Finite R-Ideal Automaton of the FRA  $(R, +, \cdot, \Sigma, \delta_1, \delta_2, q_0, F)$  with  $B \cap C$  as the set of all states for this Finite R-Ideal Automaton.

**Proof:** Let  $E = B \cap C$

Since  $(B, +, \cdot, \Sigma, D_1, D_2, q_B, F_B)$  and  $(C, +, \cdot, \Sigma, D_1', D_2', q_C, F_C)$  are Finite R-Ideal Automata of the FRA  $(R, +, \cdot, \Sigma, \delta_1, \delta_2, q_0, F)$ ,

$a - b \in B$ , for all  $a, b \in B$  and  $r \cdot a \in B$ , for all  $r \in R$  and for all  $a \in B$  and

$a - b \in C$ , for all  $a, b \in C$  and  $r \cdot a \in C$ , for all  $r \in R$  and for all  $a \in C$

Therefore,  $a - b \in E$ , for all  $a, b \in E$  and  $r \cdot a \in E$ , for all  $r \in R$  and for all  $a \in E$

Clearly  $(E, +, \cdot)$  is a ring which is a subring of  $(R, +, \cdot)$

As in the previous theorem  $(E, +, \cdot, \Sigma, \sigma, \sigma', q_E, F_E)$  is a Finite R-Ideal Automata of the FRA  $(R, +, \cdot, \Sigma, \delta_1, \delta_2, q_0, F)$  with  $E = B \cap C$  as the set of all states for this Finite R-Ideal Automaton.





### Immanuel Nelson and Muthukumaran

**Corollary 3.9 :** Let  $(R, +, \cdot, \Sigma, \delta_1, \delta_2, q_0, F)$  be a FRA. Let  $B_1, B_2, B_3, \dots, B_n$  be Finite R-Ideal Automata of the FRA  $(R, +, \cdot, \Sigma, \delta_1, \delta_2, q_0, F)$ . Suppose there exists some  $a \in \Sigma$  such that  $\delta_1(q_0, a) \in B_1 \cap B_2 \cap B_3 \cap \dots \cap B_n$  or  $\delta_2(q_0, a) \in B_1 \cap B_2 \cap B_3 \cap \dots \cap B_n$ . Then there exists a Finite R-Ideal Automaton of the FRA  $(R, +, \cdot, \Sigma, \delta_1, \delta_2, q_0, F)$  with  $B_1 \cap B_2 \cap B_3 \cap \dots \cap B_n$  as the set of all states of this Finite R-Ideal Automaton.

**Proof:** Using the above theorem, it may be demonstrated by induction on n.

## CONCLUSION

In many domains, but particularly in computer science, the notion of automata is crucial. In these sectors, the Finite R-Ideal Automata and Finite L-Ideal Automata will both be crucial. Additional study in this area will yield more worthwhile findings.

## REFERENCES

1. Y.Immanuel Nelson and Dr.K.Muthukumaran, "Group Actions In Finite Group Automata" *"INTERNATIONAL JOURNAL OF ADVANCED RESEARCH IN ENGINEERING AND TECHNOLOGY"*, ISSN Print :0976-6480, ISSN online :0976-6499, Volume 10, Issue 4, July-August 2019, PP 274-279.
2. Y.Immanuel Nelson and Dr.K.Muthukumaran," Finite Ring Automata", *GIS Science Journal*, Volume 9, Issue 12, December 2022, Pages 857 - 863.
3. Y.Immanuel Nelson and Dr.K.Muthukumaran, "Homomorphic Images of Finite Ring Automata", *Metszet Journal*, Volume 7, Issue 12, December 2022, Pages 312 – 321.
4. Dr.K.Muthukumaran and S.Shanmugavadivoo, "Finite Abelian Automata" *"IOSR Journal Of Mathematics"*, A Journal of "International Organization of Scientific Research" e-ISBN:2278-5728, p-ISBN:2319- 765X,Volume 14, Issue 2, Ver.II (March.-April.2018),PP 01-04.
5. S.Shanmugavadivoo and Dr. M.Kamaraj, "Finite Binary Automata" *"International Journal of Mathematical Archive"*, ISSN 2229 - 5046, 7(4),2016, Pages 217-223.
6. Dr.K.Muthukumaran and S.Shanmugavadivoo, "Finite Subgroup Automata" *"IOSR Journal of Mathematics"*, A Journal of "International Organization of Scientific Research", e-ISBN:2278-5728, p-ISBN:2319-765X,Volume 15, Issue I, Ver.I (Jan.-Feb.2019),PP 50-56.
7. Danish Ather, Raghuraj and Vinodani Katiyar, "An efficient algorithm to design DFA that accepts strings over input symbol a, b having at most x number of a and y number of b" *Journal of Nature Inspired Computing*, Vol.I, No. 2, 2013, pages 30-33.
8. Danish Ather, Raghuraj and Vinodani Katiyar, "To develop an efficient algorithm that generalize the method of design of Finite Automata that accepts "N" Base Number such that when "N" is divided by M leaves remainder "X", *IJCA ISBN*, December 2012.
9. S.Shanmugavadivoo and Dr. M.Kamaraj, "An Efficient Algorithm To Design DFA That Accept Strings Over The Input Symbol A,B,C Having Atmos X Number of A, Y Number of B, & Z Number of C" *"Shanlax International Journal of Arts, Science And Humanities"* Volume 3, No. 1, July 2015, Pages 13-18
10. John E. Hopcroft, Jeffery D.Ullman, *Introduction to Automata Theory, Languages, And Computation*, Narosa Publishing House.
11. J.P.Tremblay and R.Manohar, *Discrete Mathematical Structures with Applications To Computer Science*, Tata Mcgraw-Hill Publishing Company Limited, New Delhi, 1997.







## A Literature Review on Physiotherapy Management of Sinding Larsen Johansson Syndrome

Yashasvi Pathak<sup>1\*</sup> and Shwetha Sasidharan<sup>2</sup>

<sup>1</sup>BPT Student 4th Year, Department of Physiotherapy, Garden City University, Bengalore, Karnataka, India.

<sup>2</sup>Assistant Professor, Department of Physiotherapy, Garden City University, Bengalore, Karnataka, India.

Received: 27 Jan 2024

Revised: 09 Feb 2024

Accepted: 26 Apr 2024

### \*Address for Correspondence

#### Yashasvi Pathak

BPT Student 4th Year,  
Department of Physiotherapy,  
Garden City University,  
Bengalore, Karnataka, India.  
Email: yashap27@gmail.com



This is an Open Access Journal / article distributed under the terms of the **Creative Commons Attribution License** (CC BY-NC-ND 3.0) which permits unrestricted use, distribution, and reproduction in any medium, provided the original work is properly cited. All rights reserved.

### ABSTRACT

Knee pain, a prevalent orthopedic concern, encompasses various conditions impacting the joint's functionality. Sinding-Larsen Johansson (SLJ) Syndrome, is a specific form of knee pain commonly affecting adolescents. Characterized by inflammation at the inferior pole of the patella, SLJ Syndrome arises from repetitive stress on the patellar tendon during growth spurts. Overuse injuries to the knee are commonly reported by physically active children and adolescents, though SLJ is a rarely seen syndrome. This study is based on reviewing the relevant literature and synthesizing the knowledge domain about the physiotherapy interventions for Sinding Larsen Johansson (SLJ) Syndrome focusing on pain reduction and muscle strength enhancement as key therapeutic outcomes. PubMed, Research Gate, and Google Scholar were the databases utilized to search for research papers. 53 articles from the past 23 years were collected and reviewed in accordance with the selection criteria. The articles that focused on the physiotherapy management of SLJ syndrome were included as per the selection criteria. Five out of 53 articles were included in the review. The results indicate a comprehensive approach to rehabilitation should be explored to optimize the management of SLJ syndrome and improve the quality of care for affected individuals. We draw inferences from this literature study that a structured physiotherapy intervention plays a vital role in the management of Sinding Larsen Johansson Syndrome, aiming to alleviate pain and enhance the range of motion of the knee joint.

**Keywords:** Sinding Larsen Johansson Syndrome, Physiotherapy management for SLJ, Conservative treatment, Knee pathology, Exercises for SLJ.



**Yashasvi Pathak and Shwetha Sasidharan**

## INTRODUCTION

Knee pain is one of the most common musculoskeletal complaints seen in the pediatric and adolescent population. The complaint is most prevalent in physically active patients, with up to 54% of athletes having some degree of knee pain per year [1]. Sinding-Larsen-Johansson syndrome (SLJ) is named after Swedish surgeon Sven Christian Johansson (1880-1959) and Norwegian physician Christian Magnus Falsen Sinding-Larsen (1866-1930) who independently described the same disease process in the early 1920s [2]. The syndrome is an osteochondrosis of the inferior pole of the patella [3], which commonly occurs due to repetitive microtrauma or contraction of the muscle which results in detachment of the ossification center at the proximal patella tendon [4]. Sinding-Larsen reported an affection of the distal pole of the patella in two adolescents based on a lecture by Johansson, who was the first to describe the disease; it is believed to be an inflammation that is related to overstrain and repeated injury and, therefore, has a gradual onset of pain [5]. Symptomatic patients are usually between the ages of 10 and 12 years [6]. SLJ syndrome is caused by increased tension and pressure due to repetitive traction by the patellar tendon on the lower pole of the patella (still partly cartilaginous in adolescents) during contraction of the quadriceps muscle [7]. The disease affects the proximal tendon at its insertion into the patella [8]. It is often grouped under the general classification of “jumper’s knee” [9]. In this syndrome, pain is due to abnormal motion of the synchondrosis area that appears mainly after an acute injury event or repeated microtrauma in adolescents or athletes [10]. SLJ shows localized tenderness and soft tissue swelling [11] often coupled with the tightness of surrounding muscles, especially the quadriceps, hamstrings, and gastrocnemius which results in inflexibilities of the knee joint [12]. There is a painful site in the lower pole of the patella and the proximal region of the patellar tendon, with local inflammatory signs that lead to functional impairment of the knee [13]. SLJD appears to be rare because the incidence of radiographic abnormalities at the inferior pole of the patella has been suggested to be low (2-5%) in healthy juveniles (10-14 years of age) [14]. The pain increases during flexion combined with the loading of the knee joint [15]. This study aimed to systematically review and synthesize the existing literature on physiotherapy interventions for Sinding Larsen Johansson Syndrome focusing on pain reduction and muscle strength enhancement as key therapeutic outcomes.

## METHODOLOGY

### Study Design

A thorough literature search was conducted using the search engines Research Gate, Google Scholar, PubMed, and more. The literature review was conducted for the period from 2000 to 2023.

### Search Strategy

The keywords used were: *Sinding Larsen Johansson Syndrome, Physiotherapy management for SLJ, Conservative treatment, Knee pathology, and Exercises for SLJ*. Additionally, the article’s reference lists were examined.

### Sample Size

A sample size of 53 was obtained after searching in databases using the following keywords: *Sinding Larsen Johansson Syndrome, Physiotherapy management for SLJ, Conservative treatment, Knee pathology, and Exercises for SLJ*. Based on inclusion and exclusion criteria and year of publication, further articles were scrutinized, and finally, five appropriate articles were obtained for this systematic review.

### Inclusion Criteria

The articles were included if they have met the following criteria:

- The studies included the physiotherapy management of the SLJ Syndrome.
- The articles published between 2000-2023.
- The published studies were in the English language.
- Articles having full text.



**Yashasvi Pathak and Shwetha Sasidharan****Exclusion Criteria**

The articles were excluded if they have met the following criteria:

- Articles of past the year 2000.
- The articles that focused their data on knee syndromes other than Sinding Larsen Johansson Syndrome.
- Articles which did not contain data regarding the physiotherapy management of Sinding Larsen Johansson Syndrome.
- The articles were published in other languages.

**SELECTION OF INCLUSION AND EXCLUSION CRITERIA**

Inclusion and exclusion criteria were applied to select five articles for this review. The preference for English language articles was based on the belief that it would minimize the chances of errors in analyses. Analyzing articles in non-English languages might lead to misinterpretations and the gathering of inappropriate information. Therefore, focusing on English-language articles allows for proper analyses, interpretation, and gathering of accurate information. The selected articles spanned from 2000 to 2023, excluding those published before 2000. Only articles with full texts were considered to ensure comprehensive information retrieval. Exclusion criteria involved articles lacking data on the physiotherapy management of Sinding-Larsen-Johansson Syndrome, as they were deemed irrelevant to the study's scope. The scope of this study is regarding the Physiotherapy management of the Sinding Larsen Johansson Syndrome and hence articles containing no relevant information regarding the mentioned scope of this study were not considered shown in Figure 1.

**RESULTS**

Out of 53 articles, 5 articles shown in Table 1 were retrieved which fulfilled the eligibility criteria using the above-mentioned selection strategy. Many articles were excluded for not meeting the requirements, not fulfilling the inclusion and exclusion criteria, and many because they were duplicates.

**DISCUSSION**

This review evaluated the existing literature on physiotherapy interventions for Sinding Larsen Johansson Syndrome focusing on pain reduction and muscle strength enhancement as key therapeutic outcomes. We included only articles that included the studies focusing on the physiotherapy management of the SLJ Syndrome, articles published between the years 2000 and 2023, articles with full text, and articles with only English language. Highlighting the physiotherapy management for Sinding Larsen Johansson Syndrome is very important to administer an appropriate physiotherapy regimen and reduce the incidence of knee injuries and knee pain complaints in pediatric and adolescent age groups. The results indicated that there should be a structured rehabilitation program to release the pain and increase the range of motion of the knee joint. The article written by Douglas M. Freedman states that SLJ is universally recognized as a self-limited process, the condition is uniformly considered to be treated with routine nonoperative measures of rest, occasional immobilization, and progressive rehabilitation, whether SLJ lesions develop after multiple episodes of microtrauma or result from a single episode of macrotrauma [19]. LOUW Q reports that the standard duration of the disease typically spans nine to twelve months, with activity restriction forming the cornerstone of treatment, complemented by the potential benefits of an exercise program encompassing stretching and progressive strengthening [20]. Based on a study done by M Kuehnast, the imaging of Sinding-Larsen-Johansson syndrome may require a combination of radiographs, MRI, and ultrasound [21]. Initially, the treatment approach is conservative, involving a reduction in activity to a point where symptoms become manageable, coupled with the use of local ice massage [22]. Emphasizing different aspects of non-operative care, as revealed in a study by D.I.Clark, key components include patient education, activity modification, exercise protocols, and the application of patella taping [23]. Due to the prevalent decreased flexibility observed in many athletes along with children and adolescents, it is advisable to regularly perform hamstring stretches, and adjustments to activity



**Yashasvi Pathak and Shwetha Sasidharan**

levels may be necessary due to the pain being activity-related [24]. According to Erik Witvrouw, open kinetic chain leg extension exercises have been employed to strengthen the quadriceps muscle, while closed kinetic chain exercises simulate and replicate numerous functional movements [25]. To prevent muscle atrophy in patients with SLJ, it is imperative to start core strengthening and address flexibility or strength issues through exercises. NMT (Neuromuscular taping), will provide an increase in the functional ability of muscles by stimulating nerve responses through biochemical, emotional, and energy stimulation mechanisms to achieve the desired result as mentioned in an article by Siti Muawanah [26]. Mark De Carlo reports that Avoiding jumping, kicking, and running is crucial to prevent stress on the extensor mechanism and promote healing, with exercise progression transitioning from bilateral to unilateral and incorporating a shift from high repetition/low weight to low repetition/high weight [17]. Finalizing the rehabilitation progression includes the identification of training errors and recommendations to prevent further injury, and the utilization of a patella strap can be advantageous in controlling pain during sports activity [27]. In addressing symptom relief, Shane M. McClinton advocates a strategy that incorporates manual therapy, foot orthoses, knee taping/bracing, treatment of trigger points (e.g., dry needling), and the application of cold or heat modalities [28].

**LIMITATIONS**

- We were able to screen only 53 articles as these many relevant articles were only available in the databases. Appropriate articles obtained were 5 out of 53. This shows that not many studies have been conducted on the physiotherapy interventions for Sinding Larsen Johansson Syndrome focusing on pain reduction and muscle strength enhancement as key therapeutic outcomes.
- It should be emphasized that the review only took into consideration articles that were written in English.

**CONCLUSION**

In summary, the literature review on physiotherapy interventions for Sinding Larsen Johansson Syndrome underscores the significance of nonoperative care, including patient education, activity modification, and exercise protocols, in managing this rare condition. This particular Syndrome typically affects children and adolescents, especially athletes, but can also affect active adults involved in activities that require jumping or squatting. The findings emphasize the need for a comprehensive approach to rehabilitation, encompassing pain reduction, muscle strength enhancement, and the prevention of further injury. However, the limited number of relevant articles available for review indicated a gap in research on physiotherapy interventions for SLJ syndrome, highlighting the necessity for further investigation and the development of evidence-based guidelines. It is crucial to continue exploring innovative strategies and interventions to optimize the management of SLJ syndrome and improve the quality of care for affected individuals. Additionally, future research should focus on expanding the evidence base for physiotherapy interventions, ultimately contributing to enhanced treatment outcomes and improved quality of life for individuals with Sinding Larsen Johansson Syndrome.

**REFERENCES**

1. Rosenblatt RA, Cherkin DC, Schneeweiss R, Hart LG. The content of ambulatory medical care in the United States. An interspecialty comparison. *N Engl J Med.* 1983 Oct 13;309(15):892-7. doi: 10.1056/NEJM198310133091505. PMID: 6888482.
2. Medlar RC, Lyne ED. Sinding-Larsen-Johansson disease. Its etiology and natural history. *J Bone Joint Surg Am.* 1978 Dec;60(8):1113-6. PMID: 721864.
3. De Flaviis L, Nessi R, Scaglione P, Balconi G, Albisetti W, Derchi LE. Ultrasonic diagnosis of Osgood-Schlatter and Sinding-Larsen-Johansson diseases of the knee. *Skeletal Radiol.* 1989;18(3):193-7. doi: 10.1007/BF00360969. PMID: 2665105.



**Yashasvi Pathak and Shwetha Sasidharan**

4. Aziz, M. A., Radzi, D., & Abu Hanifah, R. (2020). Case report: A rare case of Sinding Larsen-Johansson syndrome in adult. *Malaysian Journal of Movement, Health & Exercise*, 9(2), 17-23.
5. Alassaf N. Acute presentation of Sinding-Larsen-Johansson disease simulating patella sleeve fracture: A case report. *SAGE Open Med Case Rep.* 2018 Sep 10;6:2050313X18799242. doi: 10.1177/2050313X18799242. PMID: 30210798; PMCID: PMC6131294.
6. Yen YM. Assessment and treatment of knee pain in the child and adolescent athlete. *Pediatr Clin North Am.* 2014 Dec;61(6):1155-73. doi: 10.1016/j.pcl.2014.08.003. Epub 2014 Oct 23. PMID: 25439017.
7. Valentino M, Quiligotti C, Ruggirello M. Sinding-Larsen-Johansson syndrome: A case report. *J Ultrasound.* 2012 Jun;15(2):127-9. doi: 10.1016/j.jus.2012.03.001. Epub 2012 Mar 28. PMID: 23396672; PMCID: PMC3558086.
8. Carr JC, Hanly S, Griffin J, Gibney R. Sonography of the patellar tendon and adjacent structures in pediatric and adult patients. *AJR Am J Roentgenol.* 2001 Jun;176(6):1535-9. doi: 10.2214/ajr.176.6.1761535. PMID: 11373229.
9. Valvano, Kevin & Sina, Reddog. (2017). Acupuncture Meridian-Based Myofascial Release to Treat Knee Pain in Sinding-Larsen-Johansson Syndrome: A Case Report. *AAO Journal.* 27. 15-20. 10.53702/2375-5717-27.2.15.
10. Kajetanek C, Thauat M, Guimaraes T, Carnesechi O, Daggett M, Sonnery-Cottet B. Arthroscopic treatment of painful Sinding-Larsen-Johansson syndrome in a professional handball player. *Orthop Traumatol Surg Res.* 2016 Sep;102(5):677-80. doi: 10.1016/j.otsr.2016.05.011. Epub 2016 Jul 19. PMID: 27450859.
11. Houghton KM. Review for the generalist: evaluation of anterior knee pain. *Pediatr Rheumatol Online J.* 2007 May 4;5:8. doi: 10.1186/1546-0096-5-8. PMID: 17550634; PMCID: PMC1887528.
12. Gesthuizen, Top Contributors-Yelena, Andrew Klaehn, Michelle Lee, and Naomi O'Reilly. "Sinding Larsen Johansson Syndrome."
13. López-Alameda S, Alonso-Benavente A, López-Ruiz de Salazar A, Miragaya-López P, Alonso-Del Olmo JA, González-Herranz P. Enfermedad de Sinding-Larsen-Johansson: análisis de factores asociados [Sinding-Larsen-Johansson disease: analysis of the associated factors]. *Rev Esp Cir Ortop Traumatol.* 2012 Sep-Oct;56(5):354-60. Spanish. doi: 10.1016/j.recot.2012.05.004. Epub 2012 Jul 13. PMID: 23594889.
14. WOLF J. Larsen-Johansson disease of the patella; seven new case records; its relationship to other forms of osteochondritis; use of male sex hormones as a new form of treatment. *Br J Radiol.* 1950 Jun;23(270):335-47. doi: 10.1259/0007-1285-23-270-335. PMID: 15420380.
15. Draghi F, Danesino GM, Coscia D, Precerutti M, Pagani C. Overload syndromes of the knee in adolescents: Sonographic findings. *J Ultrasound.* 2008 Dec;11(4):151-7. doi: 10.1016/j.jus.2008.09.001. Epub 2008 Oct 30. PMID: 23396316; PMCID: PMC3552786.
16. Rajahalme, Alfons. "Physiotherapy in Sinding-Larsen-Johansson." (2022).
17. De Carlo M, Armstrong B. Rehabilitation of the knee following sports injury. *Clinics in sports medicine.* 2010 Jan 1;29(1):81-106.
18. Gerbino PG. Adolescent anterior knee pain. *Operative Techniques in Sports Medicine.* 2006 Jul 1;14(3):203-11.
19. Freedman DM, Kono M, Johnson EE. Pathologic patellar fracture at the site of an old Sinding-Larsen-Johansson lesion: a case report of a 33-year-old male. *J Orthop Trauma.* 2005 Sep;19(8):582-5. doi: 10.1097/01.bot.0000151817.55551.2d. PMID: 16118568.
20. Louw O. Anterior knee pain: uncommon aetiologies. *South African Journal of Physiotherapy.* 2003 May 1;59(2):25.
21. Kuehnast, Marianne & Mahomed, Nasreen & Mistry, Bhadrish. (2012). Sinding-Larsen-Johansson syndrome. *South African Journal of Child Health.* 6. 10.7196/sajch.423.
22. Jackson AM. Anterior knee pain. *The Journal of Bone and Joint Surgery. British volume.* 2001 Sep;83(7):937-48.
23. Clark DI, Downing N, Mitchell J, Coulson L, Syzpryt EP, Doherty M. Physiotherapy for anterior knee pain: a randomised controlled trial. *Ann Rheum Dis.* 2000 Sep;59(9):700-4. doi: 10.1136/ard.59.9.700. PMID: 10976083; PMCID: PMC1753277.
24. Patel DR, Villalobos A. Evaluation and management of knee pain in young athletes: overuse injuries of the knee. *Transl Pediatr.* 2017 Jul;6(3):190-198. doi: 10.21037/tp.2017.04.05. PMID: 28795010; PMCID: PMC5532199.





**Yashasvi Pathak and Shwetha Sasidharan**

25. Witvrouw E, Lysens R, Bellemans J, Peers K, Vanderstraeten G. Open versus closed kinetic chain exercises for patellofemoral pain. A prospective, randomized study. *Am J Sports Med.* 2000 Sep-Oct;28(5):687-94. doi: 10.1177/03635465000280051201. PMID: 11032226.
26. Muawanah S. The Effectiveness of Neuromuscular Taping (NMT) Application and Core Stability Exercise to Increase Agility in the Case of Jumpers Knee at PTPN V Pekanbaru Soccer School University Abdurrab. *Proceeding ISETH (International Summit on Science, Technology, and Humanity).* 2022:105-9.
27. Chew KT, Lew HL, Date E, Fredericson M. Current evidence and clinical applications of therapeutic knee braces. *Am J Phys Med Rehabil.* 2007 Aug;86(8):678-86. doi: 10.1097/PHM.0b013e318114e416. PMID: 17667199.
28. McClinton SM, Cobian DG, Heiderscheit BC. Physical Therapist Management of Anterior Knee Pain. *Curr Rev Musculoskelet Med.* 2020 Dec;13(6):776-787. doi: 10.1007/s12178-020-09678-0. Epub 2020 Oct 30. PMID: 33128200; PMCID: PMC7661565.

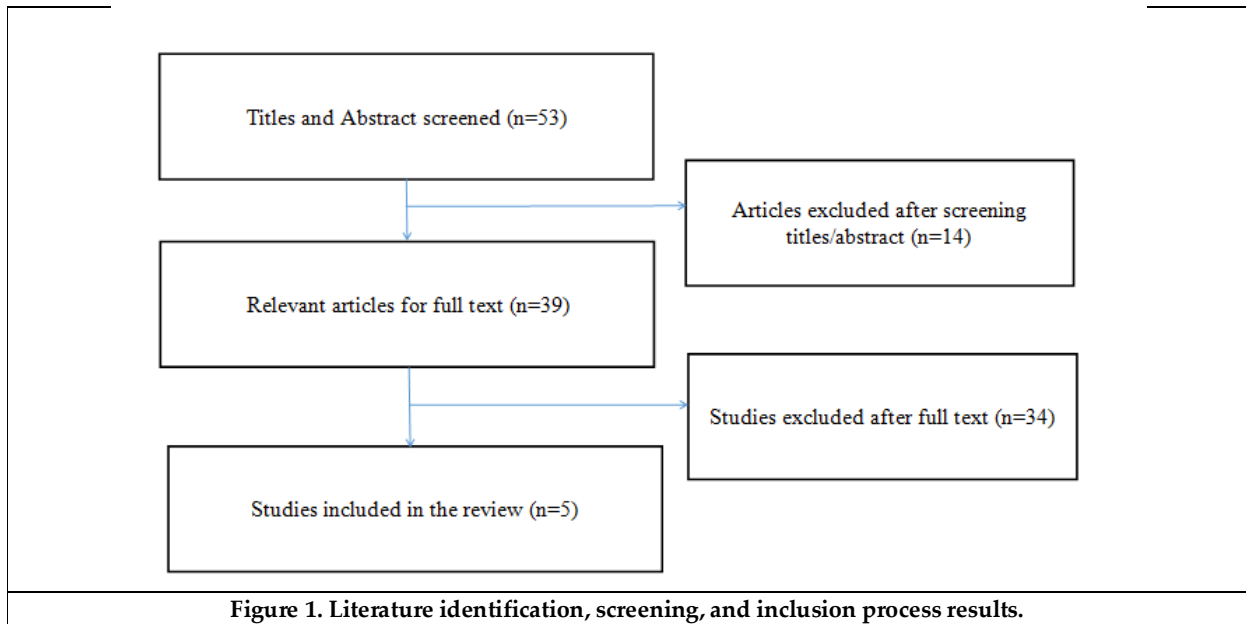
**Table 1. The findings of these five articles are summarized in the table below.**

Author/Study, Year	Title of the article	Study aims and objectives	Findings from the article
Rajahalme, Alfons (2022) [16]	Physiotherapy in Sinding Larsen Johansson Syndrome.	Compile factual data on the role of physiotherapy in the treatment of Sinding Larsen Johansson Syndrome.	The thesis aims to provide evidence-based knowledge on the treatment and prevention of SLJS, emphasizing the importance of physiotherapy interventions such as stretching and strengthening exercises.
Yelena Gesthuizen, Andrew Klaehn, Michelle Lee and Naomi O'Reilly (2012) [12]	Sinding Larsen Johansson Syndrome.	The article aims to highlight the importance of recognizing the significance of the injury at the time of initial presentation to prevent chronic rates associated with delayed treatment.	SLJ is associated with localized pain worsened by exercise, inflexibilities of the knee joint, and altered stress through the patellofemoral joint.
Mark De Carlo, PT, DPT, MHA, SCS, ATC*, Brain Armstrong, MPT (2010) [17]	Rehabilitation of knee following sports injury.	Insight on proper knee rehabilitation followed by a sports injury in children and adolescents.	Rehabilitation programs should be individualized and based on the anatomy of the involved structures, biomechanics of the knee joint, and the stage of healing.
Houghton KM (2007) [11]	Review for the generalist: evaluation of anterior knee pain.	Providing a concise yet comprehensive overview of Sinding-Larsen-Johansson involves delving into the specifics of this condition.	The article provides several key findings on Sinding-Larsen-Johansson-Syndrome including its clinical presentation, differentiation from other conditions, and management strategies.
Peter G. Gerbino, MD (2006) [18]	Adolscent Anterior Knee Pain.	Highlights the importance of accurate diagnosis and appropriate interventions for successful treatment outcomes.	Nonoperative treatment is usually the first approach for adolescent anterior knee pain, but specific operative interventions may be necessary in cases where nonoperative treatment is ineffective or inadequate





**Yashasvi Pathak and Shwetha Sasidharan**





## Pharmacognostical and Analytical Study of Shatadhauta Jivaniya Ghrita: An Ayurvedic Polyherbal Formulation

Shalaka More<sup>1\*</sup> and Manjiri Keskar<sup>2</sup>

<sup>1</sup>Associate Professor, Department of Shalaky Tantra, Parul Institute of Ayurved, Parul University, Gujarat, India.

<sup>2</sup>Professor and HoD, Department of Shalaky Tantra, Parul Institute of Ayurved, Parul University, Gujarat, India.

Received: 30 Jan 2024

Revised: 09 Feb 2024

Accepted: 26 Apr 2024

### \*Address for Correspondence

#### Shalaka More

Associate Professor,  
Department of Shalaky Tantra,  
Parul Institute of Ayurved,  
Parul University, Gujarat, India.  
Email: vdshalakapawar@gmail.com



This is an Open Access Journal / article distributed under the terms of the **Creative Commons Attribution License** (CC BY-NC-ND 3.0) which permits unrestricted use, distribution, and reproduction in any medium, provided the original work is properly cited. All rights reserved.

### ABSTRACT

In the modern digitalized era, the incidence and prevalence of *Shushkaakshipaka*, or dry eyes, are increasing, imposing a large burden on health services. In the classical literature of *Ayurved; Jivaniya Ghrita* is indicated for the treatment of *Shushkakshipaka* (Dry eye). In the present study, on undergoing *Dhauta Samskara*, the trial medication *Shatadhauta Jivaniya Ghrita* is subjected to clinical trial in *Shushkakshipaka* (Dry eye) To establish standard quality parameters for *Shatadhauta Jivaniya Ghrita*. *Jivaniya Ghrita* was prepared by classical *ghrita Kalpana* method, then washed one hundred times with water to get the final product *Shatadhauta Jivaniya Ghrita*. Standard Operation Procedure were adopted and recorded accordingly. *Shatadhauta Jivaniya Ghrita* was subjected for quality control parameters through Organoleptic, Physico – chemical evaluation, Phyto-chemical analysis, anti-microbial study, particle size analysis, Spreadability by Texture Analyser and High-Performance Thin Layer Chromatography fingerprinting (HPTLC). Rancidity was negative indicating that the physico-chemical parameters are in acceptable range, also the sample was free from contamination. The present work was carried out to standardize the finished product *Shatadhauta Jivaniya Ghrita* in terms of its identity quality and purity. Pharmacognostical and physico chemical observations revealed the specific characters of all active constituents used in the preparation, which impacts a good therapeutic property.

**Keywords:** Dry Eye, *Ghrita*, HPTLC, *Jivaniya*, Organoleptic, Pharmacognosy, Pharmaceutical, *Shatadhauta*, *Shushkakshipaka*.







## Shalaka More and Manjiri Keskar

## INTRODUCTION

*JivaniyaGhrita* is an Ayurvedic formulation, indicated for treating *shushkaakshipaka* (dry eye syndrome) in *Sushruta Samhita*<sup>[1]</sup> and classical ayurvedic treatises. It has shown encouraging clinical outcome in *shushkakshipaka*. Encouraged by this outcome present study is aimed to see the effect of *shatdhautajivaniyaghrita* under the title “An Open Labelled Randomized Controlled Clinical Trial of *ShatdhautajivaniyaGhrita* in The Management of *Shushkaakshipaka*”. *ShatadhautajivaniyaGhrita* is an Ayurvedic formulation prepared by doing one hundred times *dhavan*(wash) of *jivaniyaghrita* with water. This particular preparation is a modified form of *jivaniyaghrita*. Hence an attempt has been made to study *ShatadhautajivaniyaGhrita* by pharmacognostical, preliminary phytochemical, physico-chemical parameters and to develop HPTLC (High-Performance Thin Layer chromatography study) fingerprints of the compound formulation *ShatadhautajivaniyaGhrita*.

**Importance of *Shatadhauta Samskara***

As the name denotes, it is prepared by washing Ghee one hundred times with water <sup>[2]</sup> As the washing continuous, due to pressure applied during rubbing, particle size of fat granules gets reduced. Eventually, successive washings result in oil in water type of emulsion. The characteristic granular, oily consistency and odour present in the ghee is lost, resulting in a homogeneous, smooth, nonoily product, which is easier to apply, thus improving the patient compliance as a base for topical application. pH changes from acidic to neutral makes it beneficial in preventing irritation. Reduction in particle size of *Shatadhautaghrita* makes the product nongranular, non-sticky, homogeneous, with a large surface area, similar to that of modern cream base which makes it easy to apply and may result in increased rate of absorption. As per modern ocular therapeutics the tissue contact time of *Shatadhautaghrita* is more so bioavailability of drug is also increased allowing better absorption.

## MATERIALS AND METHODS

**Procurement of Raw Drug**

The raw drugs purchased from Local Drug Dealer. All Drugs were authenticated by the Department of Pharmacognosy, Parul institute of Pharmacy, Parul university, Vadodara. Certified Cow ghee was purchased by Shuddham Gaushala, Shuddham Organics, Meerut, Uttar Pradesh.

Method of Preparation:

It was prepared in two steps:

1. Preparation of *JivaniyaGhrita*.
2. Preparation of *ShatadhautajivaniyaGhrita* – by *Dhawan Samskara* (Hundred Wash with Water).

**Substitute of *JivaniyaMahakashaya***

*Jivaniyaghrita* which has been prepared for the study contains substitutes of some of the drugs of *JivaniyaAushadhi*. These drugs are

1. *Vidarikand* (Substitute of *Jivaka, Rishbhaka*) <sup>[3]</sup>
2. *Shatavari* (Substitute of *Meda, Mahameda*) <sup>[4]</sup>
3. *Ashwagandha* (Substitute of *Kakoli, Ksheerkakoli*) <sup>[5]</sup>
4. *Mudgaparni*
5. *Mashaparni*
6. *Jeevanti*
7. *Mulethi*

**Method of Preparation of *JivaniyaGhrita***

The *JivaniyaGhrita* was prepared by classical method of *Ghritapaka*. For *Ghritapaka* 1kg *ghrita* was taken, *dravdravya*: *godugdha*. *Kalka dravya*: *vidarikanda, shatavari, ashwagandha, mudgaparni, mashaparni, jeevanti, mulethi*. In a large vessel



**Shalaka More and Manjiri Keskar**

go-ghrita was poured, when it got melted under moderate flame *Murchhandravaya: haritaki, amalaki, vibheetaki, nagarmotha, haridra, nimbuswaras* were added for fifteen minutes. After *Ghritamurchhan* was done, *kalkadravya* in particular ratio were added followed by addition of *dravadravya, Godugdha*. To get final product, the contents were subjected to heat till up to *sneha siddhilakshana* were observed. Heating was stopped when *Varti* was formed and froth subsided. *Varti* was tested for absence of crackling sound. *Ghrita* was filtered while still hot (approx. 80°) through a muslin cloth and allowed to cool. After that, the *Ghrita* was packed tightly in glass containers to protect from light and moisture. The contents of *JivaniyaGhrita* and their proportion is mentioned in [Table no.1]

**Pharmacodynamics of JivaniyaGhrita:<sup>[6]</sup>**

The mode of action of a drug and its physiological effect can be best understood by the properties of its basic physiochemical factors i.e., *Rasa, Guna, Veerya, Vipaka, Karma* and *Prabhava* of the drugs. These properties affect the *Doshas* and determine their *Doshkarma* activity which in turn corrects the vitiated *Doshas* and maintain the *Doshika* equilibrium of the body. The pharmacodynamics of the selected drug (*JivaniyaGhrita*) is explained in [Table no. 2]

**Preparation of ShatadhautajivaniyaGhrita – By Dhawan Samskara (Hundred Wash with Water)**

*Jivaniyaghrita* of 1 kg is taken in a copper plate. Normal tap cold water is added above the level of ghee. Ghee and water rubbed vigorously for 6-8 minutes till water become slightly warm, and the contents were allowed to settle. Water was decanted carefully, avoiding loss of ghee. Then same cold tap water was added to the previously washed ghee and similar procedure was repeated. This procedure was carried out for one hundred times to obtain *Shatadhautaghrita*. Samples were collected after washing and stored in plastic container at room temperature for analysis. Certified Shuddham Organics Pure A2 Cow's ghee was used for preparation of *JivaniyaGhrita* and analysis of *shatadhautajivaniyaghrita* was done.

**ANALYTICAL STUDY****Organoleptic Analysis**

It was done with the help of *Panchagyanendriya Pariksha* /examination with the help of sense organs. Various parameters such as colour, odour, taste, touch and texture of the finished product were observed and recorded. [Table No.3]

**Physico-Chemical Analysis**

Physiochemical analysis such as loss on drying at 110° C, Water soluble extractive, Total Ash, Acid insoluble Ash, Alcohol soluble extract, Acid value, Peroxide value, Saponification value, Iodine value [Table No. 4]. Specific gravity at 25° C, Viscosity, Refractive index, tests were carried out.

**Phyto-Chemical Analysis**

Preliminary tests were carried out on methanolic extract for the presence or absence of phytoconstituents like alkaloids, tannins & phenolic compounds, flavonoids, saponins and Anthraquinone glycosides. [Table:5]

**Microbiological Limit Test**

Microbial load estimation shows total bacterial count and total Yeast and mould count. Test for another specific pathogen is negative defined in [Table no.6]

**High-Performance Thin-Layer Chromatography Study****Methodology of High-Performance Thin-Layer Chromatography**

The formulation was subjected to bioactive compound identification. Toluene: Ethyl Acetate:Glacial Acetic Acid (8:2:2:0.1 v/v) was used as the mobile phase. The procedure was deemed to be satisfactory. As a result, the method validation was carried out.

General experiment details

1. Temperature-100±5°C
2. Humidity-40%
3. Preparation of Test Solution:





### Shalaka More and Manjiri Keskar

0.5 g of sample is taken in a beaker and to it 20 mL of Methanol is added. It is refluxed for 30 Minutes. After cooling the sample is filtered through Whatman Filter Paper No.1. Filter the obtained methanol with 0.45-micron membrane filter. The filtrate of the sample is collected. The test solution thus obtained is used for HPTLC fingerprinting.

#### 4. Preparation of Spray reagent [Anisaldehyde – sulphuric acid reagent]:

0.5 mL Anisaldehyde is mixed with 10 mL Glacial acetic acid, followed by 85 mL Methanol and 5 mL Sulphuric acid (98 %). 2.0 µl of the above extract were applied on a pre coated Silica gel 60 F<sub>254</sub> on aluminum sheets to a band width of 10 mm using CAMAG Linomat 5-TLC applicator.

### Experimental method

- Sample Preparation – Extracted using methanol
- Stationary phase-TLC silica gel 60 F<sub>254</sub>
- Standard preparations
- Mobile phase - Toluene: Ethyl Acetate: Glacial acetic acid (8:2:0.1 v/v)
- Development Chamber-Saturated chamber with Whatman filter paper no.1 Developing Distance 80 mm from the lower edge
- Documentation-At 254 nm & 540nm
- Chromatogram-At 254 nm & 540nm

Rf values obtained by HPTLC fingerprinting is shown in [Table No.7]

### DISCUSSION

Identification of original drug is the first step to maintain the quality of the final product. All the ingredients were authenticated with help of characters mentioned in the API. In the sample Flavonoids, Steroids, Triterpenoids and Anthraquinones were present. Physico-chemical parameters were compared with API and found within the limits. pH shows that the aqueous solution of ghrita is alkaline in nature. HPTLC fingerprinting for *ShatadhautajivaniyaGhrita* reveals four spots of rf values 0.28, 0.42, 0.53, 0.84 in short wave uv 254 nm. In long wave uv 540 nm seven spots at 0.14, 0.25, 0.28, 0.42, 0.60, 0.65, 0.78 Rf values were observed.

### CONCLUSION

The formulated *ShatadhautajivaniyaGhrita* can be used for the management of *Shushkakshipaka* (Dry Eye Syndrome). Physiochemical profile, TLC fingerprint, Microbials limit tests are essential parameter for the quality of formulation. All parameters in this preparation were found within normal limits. On that basis we may conclude that the formulated *Shatadhautajivaniyaghrita* is compatible to the patients and have stable shelf life at room temperature. For the prospective research, study will be helpful for the establishment of safety profile, efficacy and acceptance of Modified *Shatadhautajivaniyaghrita* formulation.

### REFERENCES

1. Sushruta Samhita, Uttara Tantra of M harshi Sushruta, Edited with Ayurvedic TatwaSandipika. By Kaviraj AmbikaduttaShashtri Part ii. Varanasi: Chaukhamba Orientalia: 2004.p.149.
2. Acharya S.N. Mishra, Abhinava Bhaishajyakalpana-vijnana 4th edition, 1993, ChaukhambaSubhartiPrakashana, page 301.
3. Bhavaprakasanighantuyukta of Shri BhavMisraVidyotini Hindi Vyakhya Part-1, Shlok, 156, 182 Reprint edition 2013, Chaukhamba Sanskrit Sansthan.





### Shalaka More and Manjiri Keskar

4. Bhavaprakasanighantuyukta of Shri BhavMisraVidyotini Hindi Vyakhya Part-1, Shlok, 156, 182 Reprint edition 2013, Chaukhamba Sanskrit Sansthan.
5. Bhavaprakasanighantuyukta of Shri BhavMisraVidyotini Hindi Vyakhya Part-1, Shlok, 156, 182 Reprint edition 2013, Chaukhamba Sanskrit Sansthan.
6. Bhavaprakasa Nighantu of Shri BhavaMisra Prof. K.C. Chuneekar Shloka (1/153), P.No.60 Reprint edition 2013, Chaukhamba Bharti Academy.

**Table No. 1: Contents used in JivaniyaGhrita.**

Name of Drug	Latin Name	Part Used	Ratio
Vidarikanda	<i>Puraria tuberosa</i>	Fruit	0.50
Shatavari	<i>Asparagus racemosus</i>	Root	0.50
Ashwagandha	<i>Withaniasomnifera</i>	Root	0.50
Mudgaparni	<i>Phaseolus trilobus</i>	Panchang	0.25
Mashaparni	<i>Phaseolus radiates</i>	Panchang	0.25
Jivanti	<i>Leptadenia reticulata</i>	Leaves	0.25
Mulethi	<i>Glycyrrhiza glabra</i>	Root	0.25
Godugdha	<i>Lactus</i>	-	4
Go-Ghrita	<i>Butyrumdepuratum</i>	-	1

**Table No. 2: Pharmacodynamics of Jivaniyaghrita:**

Dravya	Rasa	Guna	Virya	Vipaka	Doshshamka
Vidarikanda	Madhur	Guru, Snigdha	Sheeta	Madhura	Vata- Pitta shamaka
Shatavari	Madhur, Tikta	Guru, Snigdha	Sheeta	Madhura	Vata- Pitta shamaka
Ashwagandha	Madhur, Tikta, Katu,	Laghu, Snigdha	Ushna	Madhura	Vata-Kapha shamaka
Mudgaparni	Madhur	Laghu, Ruksha	Sheeta	Madhura	Tridosha-shamaka
Mashaparni	Madhur Tikta,	Laghu, Snigdha	Sheeta	Madhura	Vata-Pitta shamaka
Jivanti	Madhur	Laghu, Snigdha	Sheeta	Madhura	Tridosha-shamaka
Mulethi	Madhur	Guru, Snigdha	Sheeta	Madhura	Vata- Pitta shamaka
Godugdha	Madhur	Guru, Snigdha	Sheeta	Madhura	Vata- Pitta shamaka
Go-Ghrita	Madhur	Guru, Snigdha	Sheeta	Madhura	Vata- Pitta shamaka

**Table No.3: Organoleptic parameters of ShatadhautajivaniyaGhrita**

Parameters	Results
Colour	Light Green
Odour	Characteristics
Touch	Unctuous
Taste	Bitter
Appearance	Semi-solid

**Table No.4: Physico-Chemical Analysis**

Sr.No.	Parameter	Result
1	pH	7.1
2	Specific Gravity	0.948
3	Refractive Index	1.442
4	Acid value	1.98
5	Peroxide value	0.00
6	Saponification value	94.3
7	Iodine value	23.4





**Shalaka More and Manjiri Keskar**

**Table No.5:Phyto-chemical Analysis**

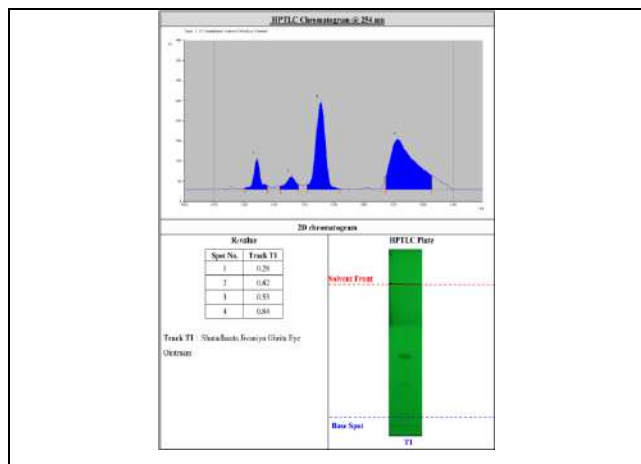
Sr.No.	Parameter	Result
1	Alkaloid	-
2	Flavonoids	+
3	Tannins & Polyphenols	-
4	Steroids	+
5	Triterpenoids	++
6	Saponin	-
7	Anthraquinones	+
8	Carbohydrates	-
9	Protein	-
10	Starch	-

**Table No.6: Microbiological Analysis**

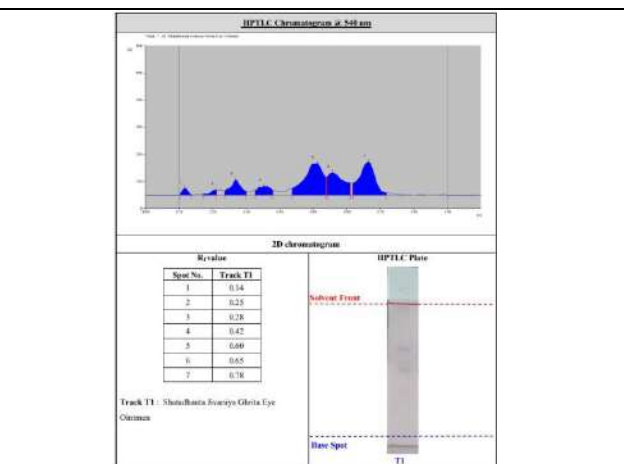
1	Total Microbial Plate Count	1580 cfu/g
2	Total Yeast & Mould Count	Absent
3	Staphylococcus aureus	Absent
4	Salmonella sp.	Absent
5	Pseudomonas aeruginosa	Absent
6	Escherichia coli	Absent

**Table No.7: Rf values obtained by HPTLC fingerprinting:**

Sample	Visualize under short UV (254nm)		Visualize under long UV (540nm)	
	No. of spots	Rf values	No. of spots	Rf values
ShatadhautaJivaniyaGhrita	4	0.28,0.42,0.53,0.84	7	0.14,0.25,0.28,0.42,0.60,0.65,0.78



**Fig.1. HPTLC plate showing banding pattern and Rf Values at 254nm**



**Fig.2. HPTLC plate showing banding pattern and Rf Values at 540 nm**





## Nutritional Composition of Golden Sweet Potato and its Role in Alleviating Vitamin-A Deficiency through a Food based Approach

Nidhi Singh<sup>1</sup> and Kumari Sunita<sup>2\*</sup>

<sup>1</sup>Research Scholar, Department of Botany, Deen Dayal Upadhyaya University, Gorakhpur, Uttar Pradesh, India.

<sup>2</sup>Assistant Professor, Department of Botany, Deen Dayal Upadhyaya University, Gorakhpur, Uttar Pradesh, India.

Received: 30 Jan 2024

Revised: 09 Feb 2024

Accepted: 26 Apr 2024

### \*Address for Correspondence

**Kumari Sunita**

Assistant Professor,  
Department of Botany,  
Deen Dayal Upadhyaya University,  
Gorakhpur, Uttar Pradesh, India.



This is an Open Access Journal / article distributed under the terms of the **Creative Commons Attribution License** (CC BY-NC-ND 3.0) which permits unrestricted use, distribution, and reproduction in any medium, provided the original work is properly cited. All rights reserved.

### ABSTRACT

Despite being labeled as "poor man's food" or a "famine crop," sweet potatoes (*Ipomoea batatas* L. Lam), the second-most significant root tuber and the seventh-most significant food crop globally, have enormous potential to support a food-based approach to promote food security to alleviate poverty and to supplement as an alternative staple food for the resource-poor farmers because of its many beneficial qualities including its short lifetime, high nutritional value, high production with few inputs. The sweet potato with orange flesh is becoming more and more significant among the tropical tuber crops had a great possibility of becoming a standard diet in the consumer food chain in order to address the issue of vitamin-A deficiency. In addition to being cheapest energy source tubers are high in minerals, carbohydrates, starch, and vitamin A in the form of  $\beta$ -carotene. Therefore by consuming more of these tubers the poor who have limited access to pricey animal foods high in vitamin A, such as fish oil, eggs, milk, and butter can meet their daily needs for vitamin A and a few other critical nutrients. Being in Orange-fleshed sweet potatoes rich in  $\beta$ -carotene, a precursor of vitamin A, are currently regarded as a significant bio-fortified crop in many underdeveloped nations in reducing the deficiency of vitamin A. This paper is focused on identifying possible cultivars of Sweet potatoes with orange flesh that are rich in beta-carotene and retain a greater amount of it after cooking. The findings of this study indicate that consuming more cooked or fresh orange-fleshed sweet potatoes can significantly aid in reducing vitamin A dietary deficiencies and preventing night blindness a serious public health issue. Vitamin A is a micronutrient that is necessary for healthy growth and development. Vitamin A deficiency (VAD) is particularly common in children and pregnant women due to the greater intake requirements during critical growth phases. In developing nations, VAD is a major public health issue that can be avoided.





Nidhi Singh and Kumari Sunita

Consumption of foods rich in vitamin A is low and reliable data on VAD prevalence, particularly among vulnerable populations is lacking. This paper presents a food based approach used in maternal nutrition and health indicators.

**Keywords:** Golden Sweet Potato, Vitamin-A, Beta-Carotene, Malnutrition, VAD

## INTRODUCTION

Vitamin A deficiency is the leading cause of childhood blindness worldwide and one of the most common issues in developing nations. Even a little deficiency is linked to an increase in preschooler mortality but severe deficiencies have extremely high fatality rates. As a result, vitamin A deficiency is a serious public health issue in underdeveloped nations and is to blame for millions of infant deaths each year. Nutritionists in various developing nations have obtained evidence that a significant number of people and children do not get enough important vitamins and minerals in their diets [1]. Almost half of the world's population lacking in micronutrients may reside in India, where blindness affects roughly 40,000 children annually mostly as a result of vitamin A deficiencies. Numerous global initiatives have been underway for a long time to address vitamin A deficiency and subsequently prevent night blindness. The third strategy is a crucial food-based approach for achieving and maintaining an adequate intake of micronutrient-rich foods within the framework of an adequate overall diet. The other two strategies are supplementation programmes through the distribution of vitamin capsules, fortification of common foods with micronutrients, and the improvement of dietary quality through food diversification [2]. The most long-lasting initiatives may be those centred around food and necessitate an inter-sectoral viewpoint. Examples of such approaches include supplying agricultural and educational inputs while keeping in mind cultural, socioeconomic, market, and health circumstances. It has also been demonstrated that the introduction of new crops and home gardening are the most crucial elements of the food-based approach to enhancing the quantity and quality of food consumed. This research focuses on how orange-fleshed sweet potatoes might be used as a food-based intervention to increase vitamin A intake in tiny, marginal farming communities that are impoverished.

Sweet potato (*Ipomoea batatas L. Lam*), an important Asian vegetable, is now cultivated worldwide and is distributed in tropical and subtropical countries. Asia as a whole occupies about 78% of the world's area of this harvest and about 92% of the world's production. India is one of the main producers of this crop along with China, America, Brazil, Peru, Mexico and Thailand. China is the world's largest producer and consumer of sweet potatoes, accounting for approximately 67% of the world's area and approximately 86% of world production. India accounts for about 68% of the total production in South Asia, followed by 27% in Bangladesh and about 5% in Sri Lanka. In India, sweet potato is grown mainly in Orissa, Uttar Pradesh, West Bengal, Bihar, Karnataka, Tamil Nadu and Kerala. Sweet potato tubers are rich in starch, sugars, minerals and vitamins. Since sweet potato with orange juice is rich in  $\beta$ -carotene, it is becoming increasingly important as the cheapest source of antioxidants with several physiological properties such as anti-oxidation, anti-cancer and protection against liver damage, and is most suitable for biofortification. to fight malnutrition. a small and marginal farming community. Orange-fleshed sweet potatoes have significant potential to promote a food-based approach to treating vitamin A deficiency, a major public health problem in poor parts of the country. Thus, there is great potential for this self-sustaining crop to be introduced as a regular supplement in the consumer food chain as an alternative staple food source for resource-poor farmers in an era of widespread population growth and nutrition crisis. However, a large number of consumers are unaware of the nutritional value of some high-yielding orange-fleshed sweet potato varieties. In addition, the biochemical composition of orange-fleshed sweet potatoes varies between genotypes. Therefore, it is important to evaluate the biochemical composition of different genotypes when selecting cultivars with high  $\beta$ -carotene content. Considering all these aspects, a study was conducted on the importance of orange-fleshed sweet potato to alleviate the lack of vitamin A, and to complete this study, an evaluation of the nutritional value of tubers of different genotypes of orange-fleshed sweet potato. to select promising, optimal varieties. performance and quality.



**Nidhi Singh and Kumari Sunita**

## MATERIAL AND METHOD

Five potential cultivars of orange-fleshed sweet potato were grown at the Department of Botany DDU Gorakhpur University during winter season with three replication. The tuber yield ( $\text{Kg/m}^2$ ) of all the cultivars harvested at 120 days after planting (DAP) were recorded. After washing, peeling and shredding, fresh tubers of each cultivars were dried at  $70^\circ\text{C}$  for about 48 hours till the tubers gained constant weight to determine the  $\beta$ -carotene ( $\text{mg}/100 \text{ g}$ ) content.

## RESULT AND DISCUSSION

Significant variations in yield were observed among the variety of Golden Sweet potato (Table-1). Higher tuber yield were recorded with CIP 440127 ( $2.6 \text{ Kg/m}^2$ ), ST-14 ( $2.4 \text{ Kg/m}^2$ ), VA-43 ( $2.2 \text{ Kg/m}^2$ ), PRDF ( $1.8 \text{ Kg/m}^2$ ) and ST-13 ( $1.4 \text{ Kg/m}^2$ ). Beta carotene content of the tuber also varied significantly (Table-1). The highest and lowest Beta carotene were observed in ST-14 and ST-13. Although some degradation occurred during cooking, the  $\beta$ -carotene content of the cooked tubers in, ST-14, and CIP was still substantial. Thus, consumption of some of the orange-fleshed sweet potato cultivars like ST-14 and CIP with high Beta carotene can make a significant contribution in alleviating vitamin A malnutrition and combating night blindness which is a major public health problem in poverty stricken small and marginal farming community.

### Food uses of Golden Sweet Potato

Its flours have been used in making Cake, Cookies, Biscuits, Buns, Muffins, Candy. The roots are also used in product like Jam, Jelly, Soft drinks, Pickles, Fried Chips and so many other products.

### Food Based Strategies for Improving Vitamin A Status

Despite significant efforts and investment in tablet, capsule and injectable approaches, no significant progress has been made in reducing vitamin A deficiency in dietary supplements in developing countries in recent decades. Low dietary intake of vitamin A is the main cause of vitamin A deficiency in developing countries [3]. Although some animal foods such as fish oil, liver, egg and butter are rich in vitamin A in its true form, retinol is directly and easily used by the human body, the poor people cannot afford these expensive foods. Therefore, significant efforts must be made to promote vitamin A intake by increasing the consumption of cheap plant foods and vegetables which although not containing vitamin A as such, still contain its precursor beta-carotene, which can be converted vitamin A in the human body. Supplemental programs in alleviating vitamin A deficiency will therefore be replaced by sustainable nutrition-based strategies in the future Low et al. [4]. Orange-fleshed sweet potato has emerged as one of the most promising plant sources of  $\beta$ -carotene, vitamin -A [5]. A serving of 100-150 g of boiled sweet potato tubers with orange color can cover the daily need of vitamin A of young children, which can protect them against blindness [6]. In addition to beta-carotene and pro-vitamin A, young children and adults get enough calories vitamin C and other micronutrients through increased consumption of orange-fleshed sweet potatoes.

## CONCLUSION

Making a small change, such as changing the variety, is probably easier than introducing a whole new food. Thus, replacement of white-fleshed sweet potato varieties currently grown by farmers with new orange-fleshed varieties such as ST-14, CIP 440127 and VA-43 with high  $\beta$ -carotene would help alleviate vitamin A deficiency. production and distribution among resource-poor farmers can increase the availability of orange-fleshed sweet potatoes in poor areas. In addition to promoting the orange fleshed sweet potatoes in the home diet, nutritional education about the function and importance of vitamin-A in the diet could improve the role of vitamin-A in the fight against night blindness a major public health problem in disadvantaged areas.







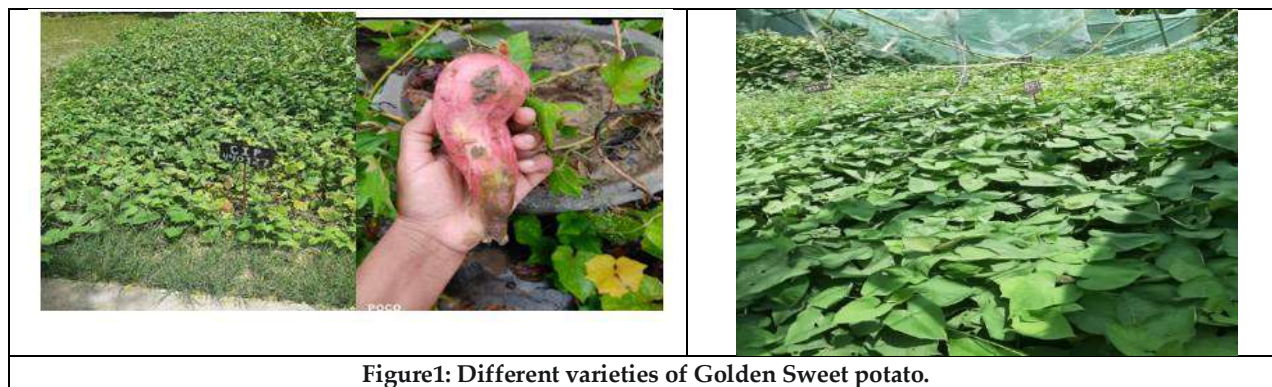
**Nidhi Singh and Kumari Sunita**

**REFERENCES**

1. United Nations, Administrative Committee on Coordination/Sub-Committee on Nutrition (1997) Third report on the world nutrition situation. World Health Organization, Geneva, Switzerland.
2. World Health Organization (1996) Indicators for assessing vitamin A deficiency and their application in monitoring and evaluating intervention programmes. World Health Organization, Geneva, Switzerland.
3. Buycks M (1996) The international community’s commitment to combating micronutrient deficiencies. Food and Agriculture Organization of the United Nations, Rome, Italy.
4. Low J, Walker T, Hijmans R (2001) The potential impact of orange-fleshed sweet potatoes on vitamin A intake in Sub-Saharan Africa. Paper presented at a regional work shop on food based approaches to human nutritional deficiencies. The VITAA Project, Vitamin A and orange-fleshed sweet potatoes in Sub-Saharan Africa, 9-11 May, Nairobi, Kenya.
5. Hagenimana V, Low J (2000) Potential of Orange-fleshed sweet potatoes for raising vitamin a intake in Africa. Food Nutr Bull 21: 414-418.
6. Tsou SCS, Hong TL (1992) The nutrition and utilization of sweet potato. Sweet potato technology for the Twenty-first Century, Tuskegee University Press, Tuskegee University, USA.

**Table-1: Performance of Different varieties of Golden Sweet potato harvested at 120 DAP.**

Genotypes	Total tuber yield (Kg/m <sup>2</sup> )	Beta-Carotene (mg/100g)
CIP 440127	2.6	6560
ST-13	1.4	5240
ST-14	2.4	9830
VA-43	2.2	6430
PRDF	1.8	5840



**Figure1: Different varieties of Golden Sweet potato.**





## Development and Validation of Method for Determining the Precise Amount of Cefotaxime in Pharmaceutical Formulations using High-Performance Liquid Chromatography (HPLC)

Basavaraj Hiremath\*

Assistant Professor, Department of Chemistry, S. S. Margol College, Shahabad – 585228 (Affiliated to Gulbarga University), Kalaburagi, Karnataka, India.

Received: 22 Jan 2024

Revised: 09 Feb 2024

Accepted: 29 Apr 2024

### \*Address for Correspondence

#### Basavaraj Hiremath

Assistant Professor,  
Department of Chemistry,  
S. S. Margol College, Shahabad – 585228  
(Affiliated to Gulbarga University),  
Kalaburagi, Karnataka, India.  
Email: drbhiremath25@gmail.com



This is an Open Access Journal / article distributed under the terms of the **Creative Commons Attribution License** (CC BY-NC-ND 3.0) which permits unrestricted use, distribution, and reproduction in any medium, provided the original work is properly cited. All rights reserved.

### ABSTRACT

Cefotaxime in vial dosage forms was rapidly and accurately measured using an isocratic HPLC approach, yielding an entire analysis time of less than 2 minutes. The separation of components was performed at room temperature using a mobile phase composed of acetonitrile and deionized water in a ratio of 60:40 (v/v). This was achieved by utilizing a Waters XTerra RP-18 column with dimensions of 5  $\mu\text{m}$ , (250 x 4.6 mm i.d). The separation process was monitored at a wavelength of 240 nm. In order to find the maximum absorption level, the experimental settings include a flow rate of 1 ml/min as well as the use of HPLC-PDA with a PDA detector adjusted at 240 nm. A shorter analysis time was likely indicated by the cefotaxime retention time, which was shown to be 1.058 min. Cefotaxime had a  $2.46 \times 10^{-3}$   $\mu\text{g/ml}$  limit of detection, suggesting that the method was very sensitive. After that, it was verified to make sure it met the standards for measuring medications in vial form of dosage that the FDA has established.

**Keywords:** Cefotaxime, Accuracy, Precision, Validation, Formulation.

## INTRODUCTION

Chemically the name of Cefotaxime sodium (CFT) is known as “(6R,7R)-3-[(acetyloxy)methyl]-7-[[[(2Z)-2-(2-aminothiazol-4-yl)-2-(methoxyimino)acetyl]amino]-8-oxo-5-thia-1-azabicyclo[4.2.0]oct-2-ene-2-carboxylate” (Figure 1). Antibiotics of the third generation, known as cephalosporin, are effective against bacteria that have developed resistance to earlier generations of antibiotics. These antibiotics kill more gram-negative bacteria, and some of those



**Basavaraj Hiremath**

bacteria can penetrate the brain's protective blood-brain barrier. Some bacteria, including Citrobacter and Staphylococcus aureus, are susceptible to third-generation antibiotics. Additionally, they are effective against  $\beta$ -lactamase-producing strains of Haemophilus and Neisseria, as well as providence, marcescent, and marcescent [1]. The earliest cephalosporin antibiotic was cefotaxime sodium, which was developed in the third century. An assortment of bacterial infections can be remedied by means of this antibacterial drug. One popular name for it is Claforan [2]. When it comes to penicillin-resistant pneumococcus strains, the most effective cephalosporin is cefotaxime sodium. It is recommended to try treating severe pneumococcal infections with penicillin as an experimental measure. Cefotaxime sodium, an antibiotic known for its high level of antimicrobial activity, broad spectrum of antibacterial properties, and exceptional resistance to  $\beta$ -lactamase, is often linked with a typical adverse effect index. The wide range of illnesses it can treat includes meningitis, peritonitis, septicaemia, urinary tract infections, and respiratory tract infections, infections of the limbs, muscles, and skin, among many others.

Cefpodoximeproxetil is a third-generation cephalosporin, and it can also be utilized as a principal intermediary in its formulation. Oral administration of a drug with comparable efficacy against pneumococcus is a relatively new development in medicine [3]. Both the favorable and negative features of cefotaxime are therapeutically and analytically significant. Its resistance to penicillinase is an advantage. Diseases resistant to penicillin or its variations may be cured with this. Though it has many positive qualities, it also has many negative ones, such as a plethora of adverse effects including headaches, diarrhea, nausea, vomiting, stomach cramps, and fainting [4]. Many experimental techniques exist for estimating CFT; one of these is spectrophotometry, which requires converting Fe (III) using (CFT) to Fe (II), which then reacts with 2,2-bipyridyl to form a red chromogen) [5-9]. Methods for atomic absorption [23] and high-performance liquid chromatography [10-22]. Based on previous research on flow-injection procedures [24–26], hemiluminescence [27], and electrochemical processes [28], this study aims to create a spectrophotometric method for the detection of CFT that is responsive, quick, and easily applicable. The method will be used for both pure extracts and pharmaceutical injectable formulations. These procedures are less recoverable, moderate precise, and linear. The high value of limit of quantification is a result of poor sensitivity, and the chromatographic duration is relatively long, about 12 min. These are two of the demerits. These methods have many problems, such as being too lengthy, detailed, complicated, less accurate, and the percentage of recovery being low and time-consuming (Table 1). The purpose of this research was to create and evaluate an easy technique for measuring the concentrations of cefotaxime in both its pure and pharmaceutical formulations within 2 min.

**EXPERIMENTAL****Apparatus**

The HPLC studies relied on equipment made by the Kyoto, Japan-based Shimadzu (UFLC) Corporation, which included a SPD-prominence diode array detector, LC-20AD solvent delivery pumps system, SIL-20A prominence auto sampler, and DGU 20A5 prominence degasser. There was additional use of Lab Solutions' data analysis tools. Notable columns employ CTO-20A ovens to maintain the ideal column temperature. For separation, the Waters XTerra RP-18, a product of Ireland, was utilized. Its dimensions are 5  $\mu$ m by 250 $\times$ 4.6mm.

**MATERIALS AND REAGENTS**

A complimentary sample of cefotaxime was supplied by the Indian company Alkem Laboratories Ltd. We used deionized water and acetonitrile HPLC-grade solvents from Merck Specialities Pvt. Ltd. in India. Formulation of pharmaceuticals is bought from a local store.

**Stock solutions**

Cefotaxime was dissolved in deionized water to create a standard solution with a concentration of 1000  $\mu$ g/ml. A volumetric flask was used to dissolve the drug in water, producing an adequate stock solution with a concentration





### Basavaraj Hiremath

of 1000 µg/ml. Stored in a dark, cold place, a solution was maintained at 35 °C. To make curves for calibration at levels of 0.25, 0.5, 1.0, 2.0, 4.0, and 8.0 µg/ml, the stock solution (1000 µg/ml) was diluted in series using the mobile phase. To achieve a dosage of cefotaxime appropriate for medicinal uses, the antibiotic was combined with a mobile phase and filtered through a 0.2 µm membrane. This was subjected to a 5 min. ultrasonic bath. For the estimation, we utilize the operational solution.

#### Mobile phase

It includes a freshly prepared 60:40 v/v of acetonitrile (ACN) to deionized water in a binary preparation we utilized a DGU 20A5 conspicuous degasser and a 0.2 µm the membrane filter to filter and degas the mobile phase before use it.

#### Pharmaceutical formulations

It purchased these pharmaceutical formulations from local retailers: Zydus Healthcare Limited (250 mg vial), Alkem Laboratories Ltd (500 mg vial), and Overseas Pharma Pvt Ltd (1000 mg vial).

## PROCEDURES

#### Construction of a calibration curve

The drug was diluted to final amounts of 0.25, 0.5, 1.0, 2.0, 4.0, and 8.0 µg/ml by using 10 ml volumetric flasks for the standard CFT stock solution. The chromatogram was obtained by introducing 10 µl of each mixture onto the column and then utilizing wavelengths of 240 nm. To illustrate the correlation between drug concentration and reaction, more precisely peak area, a concentration-response graph was drawn (Figure 2). For the purpose of validating quality control (QC) samples, low (LQC) and medium (HQC) levels were designated by values of 8.0 µg/ml.

#### Pharmaceutical formulation procedure

For the analysis, the following vial formulations were used: Biotax, Taxim, and Opitax. The mobile phase was used to dissolve an exact amount of the solution, which corresponds to 20 mg of each medicine. The solution was thereafter transferred to 100 ml gauging flasks through filtration and subsequently diluted with the mobile phase until it reached the required volume. As previously stated, the procedure was subsequently finished by employing conventional addition methods.

## RESULT AND DISCUSSION

#### Optimizing chromatographic parameters

A detailed representation of the different chromatographic conditions is provided in Table 2. In order to find the most effective wavelength for chromatographic detection, a PDA detector was used at 240 nm. Shimadzu (UFLC) Corporation of Kyoto, Japan, manufactures a number of instruments, including the SPD-prominence diode array detector, the SIL-20A prominence auto sampler, the LC-20AD solvent delivery pumps system, and the DGU 20A5 prominence degasser. Finally, the mobile phase was optimized by conducting a series of experiments to find the optimal composition ratio and pH. Acetonitrile and deionized water, in a ratio of 60:40 (v/v), with a flow rate of 1 ml/min, was observed to be the most effective mobile phase. Separation and elution of cefotaxime in both its pure form and pharmaceutical formulations may be achieved under these conditions (Figure.1) at 1.058 min. The drug can be analysed in their pure forms or synthetic mixes using the suggested (HPLC-PDA) method, which is detailed in Table 2.

#### Validation of methods

Validation of the methods was executed out in accordance with the 2005 International Conference on Harmonization (ICH) resolution [29].



**Basavaraj Hiremath****Linearity**

Five different dosage forms of the drug mixture were considered for the linearity studies. The CFT curves for calibration (Table 3) showed linearity from 0.25-8.0 µg/ml when plotting peak area against concentration. According to the results, the CFT variables' linear regression equations are  $y = 2.440167C + 4103246$ . The present method was determined to have an average accuracy of  $99.89 \pm 0.20$  and a precision of  $99.91 \pm 0.32$ , with an intermediate precision of  $99.45 \pm 0.47$ . The equation's predicted regression coefficient values ( $R^2$ ) were determined to be 1.0, indicating that CFT drugs are very linear.

**Accuracy**

Assessing the accuracy of the procedure was done by contrasting the yields of commercially accessible CFT at various levels of concentration within the given range. The conventional addition process was used in conjunction with three replicates of each concentration to achieve this. The experiment involved adding varying concentrations of each drug according to the procedure. Table 4 shows that both pharmaceuticals achieved excellent recovery rates, which were calculated as a percentage using the pharmaceutical quantity.

**Precision**

Precision was evaluated by comparing its intra- and inter-day precision. By utilizing QC samples with levels ranging from 2.0, 4.0, and 8.0 µg/ml, this validation was effectively carried out. By calculating the standard deviations (SD) for three independent measurements taken using a solution containing pure medicines, intra-day precision was assessed. The method's excellent precision was shown by the wide range of standard deviations, which ranged from 0.05 to 0.37. Table 4 shows that both the inter- and intra-day standard deviations were within the acceptable range, with both falling somewhere between 0.05-0.37. The study's findings confirm the method's precision in identifying the amounts of the drugs in pharmaceutical formulations.

**Selectivity and Specificity**

It tested the method's selectivity by introducing CFT solutions into the column one at a time. A clear peak with a retention time of 1.058 min. was the end conclusion by this proposed method. The blank solution did not show this peak. Specificity research also showed that vial formulations with excipients did not add any impurities that would have changed the clear CFT signal (Figure. 3).

**Quantification and detection limits**

The signals-to-noise ratio was set at 3:1 for the detection limits (LOD) and 10:1 for the quantitation limits (LOQ). As for CFT, the corresponding limit of detection was  $2.46 \times 10^{-3}$  µg/ml. Likewise, according to (Table 3), the CFT limit of quantification was found to be  $8.11 \times 10^{-3}$  µg/ml. Alternatively, CFT was determined by El-Hassan et al. to have quantization limits for 0.959 µg/ml and a detection limit of 0.316 µg. The outcomes we obtained reveal the extreme sensitivity of the proposed method.

**Robustness**

In order to assess the method's robustness, we maintained the other chromatographic parameters at a constant value and adjusted the flow rate and mobile phase ratio with tiny, intentional changes ( $\pm 0.05$ ). The effects of the modifications were examined by examining the drug's standard deviation and recovery percentage. The results were unaffected by the adjustments, as shown in Table 5, because the standard deviation (SD) for CFT was rather minor, at 0.56. Drug recovery averaged 100.74% at a standard deviation of 0.56 as well as RSD of 0.37.

**APPLICATIONS****Analysis of vial formulations**

Biotax, Taxim, and Opatax, three pharmaceutical formulations containing CFT were effectively analyzed using the proposed method [25-26]. The student's t-Test as well as F test was computed by statistical analysis. The fact that the



**Basavaraj Hiremath**

procedure is unaffected by any excipients or pollutants demonstrates its high degree of specificity. An F-test and Student's t-test were employed to compare the obtained results with the reference procedures. Since the computed 't' and 'F' values remained lower than the tabular ones for CFT, there was certainly none statistically significant difference in accuracy and precision between the reference and proposed approaches (Table 6).

**CONCLUSION**

The determination of CFT has been accomplished using an isocratic RP-HPLC technique. In this study, we developed and validated a method that estimates CFT concentrations rapidly and accurately; the whole analysis takes only 2.0 minutes. Based on the outcomes, it is evident that the suggested approach is fast, accurate, selective, robust, and transferable. The CFT linearity of the studied drugs was found to be in the range of 0.25-8.0 µg/ml. The method has been successfully used to analyse the commercially available vials of Biotax, Taxim, and Opitax for quality control purposes, where quick and cost-effective analysis is crucial. For routine examination of cefotaxime in its pharmaceutical and pure forms, the suggested method can be utilized in quality control laboratories in order to save the valuable time.

**ACKNOWLEDGEMENTS**

The author is very thankful to the Alkem Laboratory for providing the gift sample and S. S. Margol College, Shahabad, for their support.

**Conflict of interest**

The author says that the text does not contain any conflicts of interest.

**Ethical approval**

No research on humans or animals is included in this manuscript.

**REFERENCES**

1. Katzung BG. Basic and clinical pharmacology. 14<sup>th</sup> ed. 2018. 804-805.
2. Saeed AM, Salih ES. Indirect spectrofluorometric method for the determination of cefotaxime sodium, ciprofloxacin hydrochloride and famotidine in pharmaceuticals using bromate-bromide and acriflavine dye. Baghdad Sci. J. 2020; 17(1):1-10
3. Kondaiah S, GovindaChowdary P, Naga Raja Reddy G, SuryanarayanaRao V. Spectrophotometric determination studies of cefotaxime (CFX) and their CFXCd (II) and CFX-Cu (II) complexes. 2017; 33(1):258-268.
4. Abbas SM, Mohammed MN. Spectrophotometric determination of cefotaxime via diazotization reaction in pure and pharmaceutical samples, Ibn AL-Haitham. J Pure App Sci. 2017; 30(2):151-160.
5. Ilyas SA, Imran M, Kumar N, Shah J, Jan MR, Fazil S, Khalid M. Investigation of spectrophotometric method for determination of cefotaxime sodium in different brands of pharmaceutical preparations. 2015; 6(12):52022-52030.
6. Ali Ahmed SM, Ellbashir AA, Aboul-Enein HY. New spectrophotometric method for determination of cephalosporins in pharmaceutical formulations. Arabian J Chem. 2015; 8(2):233-239.
7. Bushra MU, Akter N, Hassan MR, Islam A, Hossain MR. Development and validation of a simple UV spectrophotometric method for the determination of cefotaxime sodium in bulk and pharmaceutical formulation. IOSR J. Pharm. 201; 4:74-77.
8. Stribet D, Vasilescu I, Radu GL. Spectrofluorimetric analysis of cefotaxime sodium by using 4-fluoro-7-nitrobenzofurazan as derivatization agent. Chem Mat Sci. 2014; 76(3):89-98.



**Basavaraj Hiremath**

9. Sayed RA, Wafaa S, Hassan MY, El-Mamml, Abdalla AS. A new extractive spectrophotometric method for the determination of gatifloxacin and cefotaxime sodium in pure and pharmaceutical dosage forms. 2012; 28(2):639-650.
10. Raut MD, Ghode SP, Kale RS, Puri MV, Patil HS. Spectrophotometric method for the simultaneous estimation of Cefotaxime Sodium and Sulbactam in Parenteral dosage forms. 2011; 3(3):10-15.
11. Li J, Zhang M, Li Q. Spectrophotometric determination of cefotaxime sodium with potassium ferricyanide. 2011; 28(1):88-93.
12. Rageh AH, El-Shaboury SR, Saleh GA, Mohammed FA. Spectrophotometric method for determination of certain cephalosporins using 4-chloro-7-nitrobenzo-2-oxa-1, 3-diazole (NBD-Cl). Nat Sci. 2010; 8(2):828-840.
13. Arafat AB, Kon SG, Mikov M. The measurement of cefotaxime sodium in rat plasma after oral administration: a sensitive HPLC-UV method. Int J Pharm Sci. 2015; 7(4):6-34.
14. Iqbal MS, Bahari MB, Darwis Y, Iqbal MA, Hayat A, Gantala V. An RP-HPLC-UV method with SPE for cefotaxime in all-in-one total parenteral nutritional admixtures: application to stability studies. Int J AOAC. 2013; 96(2):290-294.
15. Shah RY, Jat RY. Reverse phase high performance liquid chromatographic method for the quantification of cefotaxime sodium in pharmaceutical dosage form. 2015; 5(3):96-100.
16. Luhputu MKD, Djoka W, Ika P, Rizka H, Endang L. Bio Analytical and validation high-performance liquid chromatography method for simultaneous quantification cefotaxime and ciprofloxacin in human plasma. J App Pharm Sci. 2024; 14(1):221-229.
17. Mahmoud M, Sebaiya, Sobhy M, El-Adla, Samar S, Elbaramawia, Shaban AA, Abdel-Raheemb, AlaaNafiea. Developing a highly validated and sensitive HPLC method for simultaneous estimation of cefotaxime and paracetamol in pure and pharmaceutical preparations. 2024; 13:435-444.
18. Mostafa F, Al-Hakkani. HPLC Analytical Method Validation for Determination of Cefotaxime in the Bulk and Finished Pharmaceutical Dosage Form. 2020; 1(1):34-42.
19. Lalitha N, Sanjay Pai PN. Development and validation of RP-HPLC method for estimation of Cefotaxime sodium in marketed formulations. J Basic Cli Pharm. 2010; 1(1):1-10.
20. El-Beltagy HE, Amin AS, El-Balkeny MN, Madkour SA. Simultaneous determination of cefepime, cefotaxime and ceftriaxone in pharmaceutical formulation by HPLC method. 2019; 14(1):81-87.
21. Lalitha N, Pai PS. Development and validation of RP-HPLC method for estimation of cefotaxime sodium in marketed formulations. J Basic Cli Pharm. 2009; 1(1):26-28.
22. Ahmed NR, Omar FK. HPLC method for determination of paracetamol in pharmaceutical formulations and environmental water samples. 2018; 7(15):1-10.
23. Aleksic MM, Kapetanovic V, Atanackovic J, Jovic B, Zecevic M. Simultaneous determination of cefotaxime and desacetylcefotaxime in real urine sample using voltammetric and high-performance liquid chromatographic methods. Talanta. 2008; 77(1):131-137.
24. Samanidou VF, Tsochatzis ED, Papadoyannis. HPLC determination of cefotaxime and cephalaxine residues in milk and cephalaxine in veterinary formulation. Micro ChimActa. 2008; 160(4):471-475.
25. Ling SSN, Yuen KH, Barker SA. Simple liquid chromatographic method for the determination of cefotaxime in human and rat plasma. J Chrom B. 2003; 783(1):297-301.
26. Hammood MK, Qasim AW, Jasim F. An indirect atomic absorption spectrophotometric determination of cefotaxime in pharmaceutical formulations by using rhodium (II) as a mediating metal. Nat J Chem. 2011; 41:27-37.
27. Khalaf MA, Hammood MK. Validation of flow injection method for determination of cefotaxime sodium in injection dosage using fluorometric detector. Int J Sci Nat. 2018; 9(2):1983-200.
28. Al-Abachi MQ, Al-Ward HS, Mahammad YH. Batch and flow-injection spectrophotometric determination of sodium cefotaxime in pharmaceutical preparations. Iraqi J Sci. 2012; 53(2):241-249.
29. International Conference on Harmonization of Technical Requirements for Registration of Pharmaceuticals for Human Use, ICH Harmonized Tripartite Guideline, Validation of Analytical Procedures: Text and Methodology Q2(R 1). London. 2005.





## Basavaraj Hiremath

Table 1: Comparison of the proposed HPLC technique to those currently in use

Sl. No.	Method	Experimental details	Detection wavelength	LOQ in µg/ml	Linear Range in µg/ml	Remarks	Ref. No.
1	RP-HPLC	A PDA detector is an accessory for the Labtronic Model 3201 (LC -2010 <sup>TH</sup> -Liquid Chromatography). The column is a Promesil C18 (250 mm, 4.6 mm, 5 µm). A 37:63 v/v ratio of phosphate buffer to acetonitrile was employed as the mobile phase.	254 nm	0.956	1 – 20	There is long retention duration (around 8 minutes), a broad linear operating range, a low precision and accuracy, and a high limit of quantification.	[15]
2	RP-HPLC	The HPLC system is a Hitachi L-2420 UV-Vis detector coupled with an L-2130 pump. The Luna Phenomenex® C18 chromatographic column (250 × 4.6 mm i.d; 5µm) was utilized by the LC system. Mixtures of phosphate buffer (0.02 M, pH 3.0), ammonium chloride (ACN), and methane (MeOH) in the proportions of 80:12:8, volume/volume, make up the mobile phase.	280 nm	0.2	0.2 – 10	A retention time of more exceeding 8.0 min. is considered less sensitive and less accurate.	[16]
3	HPLC	A Thermo Scientific® Venusil XBPC18 (L) (5µm, 4.6x250 mm) was used in the separation technique, which was carried out at room temperature with a mobile phase that was ACN:Distilled water (70:30, v/v). The flow rate that was used in the experiment was 1 ml/min.	255 nm	1.4x10 <sup>-5</sup>	2.5-100	Relative standard deviation (RSD) > 1.694%, low sensitivity, and high linear dynamic range. It takes 1.79 minutes.	[17]
4	RP-HPLC	In chromatography, a BDS column that contains an reversed phase, which has dimensions of (150 mm x 4.0 mm x 5 µm), is utilized. To prepare the mobile phase, 1000 ml of methanol and 130 mL of the phosphate buffer were mixed.	235 nm	107.6	1.0-20	A relative standard deviation of just 0.19 was found for all six replicates, while the mean retention time was 12.515 min. Extremely linear calibration capable with minimal sensitivity.	[18]
5	RP-HPLC	An isocratic RP-HPLC system was developed by applying a	252 nm	0.6	10-70	Recovery was approximately 97%	[19]







**Basavaraj Hiremath**

		mobile phase that was 85:15 v/v of an ammonium acetate (AA) buffer (pH 6.8) and acetonitrile on an SS Wakosil II- C8 column that had a measurement of 250 mm × 4.6 mm i.d. having a particle size of 5 µm.				whereas retention duration was 5.57 min., which is less exact and precise.	
6	RP-HPLC	A C18 column (250 mm × 4.6 mm) with a particle size of 5 µm and acquired from the USA was used for chromatographic separation. A mixture of 25% acetonitrile and 75% formic acid (by volume) yielded the best mobile phase. The formic acid concentration was 0.1%.	260 nm	20.0	50-200	Lower accuracy and precision, with a high limit of quantification and a linear range. The retention period is 4.19 minutes.	[20]
7	RP-HPLC	The separation process was carried out on a Waters XTerra RP-18 column (with an internal diameter of 5 µm and a length of 250 × 4.6 mm) running at 240 nm, with a mobile phase that was 60:40 (v/v) acetonitrile to deionized water.	240 nm	8.11 × 10 <sup>-3</sup>	0.25-8.0	With a retention time of just 1.058 min., it is incredibly sensitive, easy to use, accurate, precise, and user-friendly.	Current Method

**Table 2: Chromatographic parameters for the planned HPLC method**

Parameter details	Conditions
HPLC Column	The Waters XTerra RP-18 column has an internal diameter of 4.6 mm and a 5 µm diameter.
Mobile phase	A mobile phase was made up of acetonitrile and deionized water in a 60:40 (v/v) ratio. DGU 20A5 prominence was the degasser at ambient temperature.
UV detection	240 nm
Flow rate	1.0 ml/min
Injected volume	10 µl
Temperature in °C	Ambient
CFT retention time	1.058 min.

**Table 3: The proposed method cefotaxime results and parameters**

Parameters	Cefotaxime		
	Conc. Taken (µg/ml)	Conc. Found (µg/ml)	% Recovery
	2	2.001	100.05
	4	4.013	100.33
	8	7.995	99.94





**Basavaraj Hiremath**

Mean recovery*			100.11
N			3
±SD			0.2011
±RSD			0.2009
Regression equation**			
Slope (b)	4103246		
Intercept (a)	2.440167		
LOD	2.46×10 <sup>-3</sup>		
LOQ	8.11×10 <sup>-3</sup>		
Correlation coefficient (r) 1.0			
Accuracy (mean ±SD)			99.89±0.20
Precision Repeatability (±%RSD)			99.91±0.32
Intermediate precision			99.95±0.47

\*Average of three independent procedure.

\*\*Y=a+bC, where Y is the peak area, C is the concentration of the drug in (µg/ml).

**Table 4: Findings of the standard addition recovery method**

Vial of Injection studied	Proposed Method			
	CFT in Injection µg/ml	Pure CFT added µg/ml	Total CFT found µg/ml	Pure CFT Recovered percent ± SD*
Biotax 250 mg	1.995	2	4.000	100.12 ± 0.05
	1.995	4	5.998	100.05 ± 0.17
	1.995	8	9.997	100.02 ± 0.24
Taxim 500 mg	3.997	2	6.001	100.06 ± 0.13
	3.997	4	7.996	99.98± 0.37
	3.997	8	11.996	99.96 ± 0.21
Opitax 1000 mg	7.995	2	9.998	100.03 ± 0.09
	7.995	4	11.94	99.99 ± 0.11
	7.995	8	15.993	99.98 ± 0.31

\*Mean value of three determinations.

**Table 5: Results of robustness at different temperate**

Flow rate in ml/min	Temperature in °C	CFT Conc. Found in (µg/ml)	% of Recovery
0.9	22	8.05	100.62
1.0	24	8.11	101.37
1.2	26	8.02	100.25

**Table 6: Pharmaceutical and reference method statistical data**

Name of pharmaceutical dosage	Nominal quantity	Labelled % standard deviation (SD)	
		Reference method	Proposed method
Biotax <sup>a</sup>	250 mg	99.90 ± 0.10	99.88 ± 0.08, t = 0.37, F = 1.59
Taxim <sup>b</sup>	500 mg	99.91 ± 0.07	99.90 ± 0.10, t = 0.05, F = 0.60
Opitax <sup>c</sup>	1000 mg	99.91 ± 0.10	99.90 ± 0.08, t = 0.11, F = 0.62





**Basavaraj Hiremath**

\* Manufactured by: a. Zydus healthcare Ltd.; b. Alkem Laboratories Ltd.; c. Overseas Pharma Pvt. Ltd., India. The t-value determined at the 95% level of significance is 2.365. A tabulated F-value of 3.79 indicates a level of confidence of 95%.

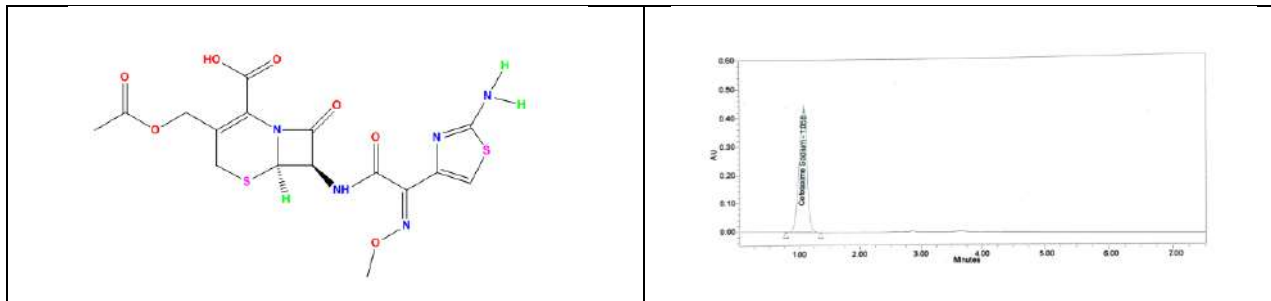


Figure 1: Chemical structure of CFT

Figure 2: Chromatogram of cefotaxime at 8.0 µg/ml.

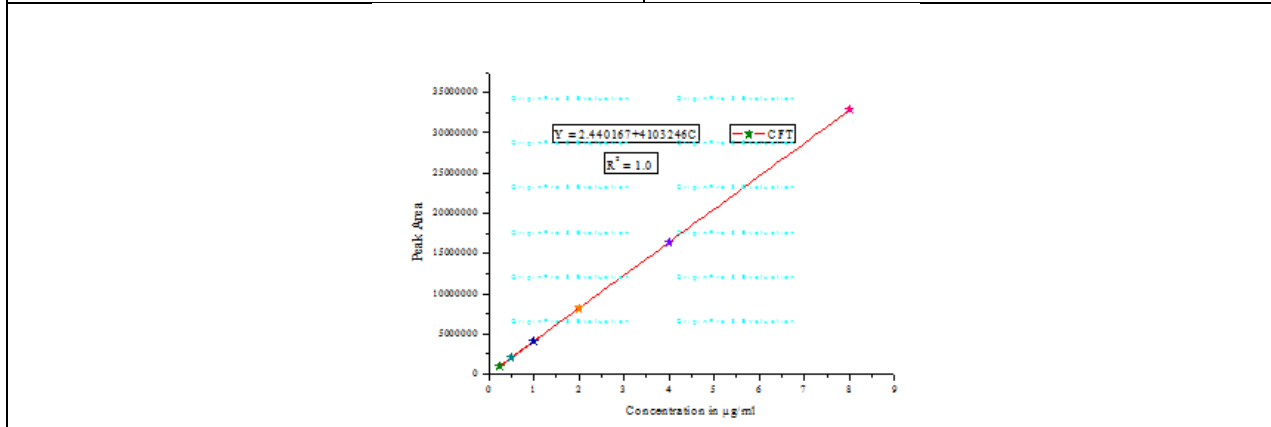


Figure 3: Calibration plot of concentration of CFT vs peak area





## Omega 3 Fatty Acid in Flaxseed Oil: A Promising Treatment for Oral Submucous Fibrosis

Aiswarya Chandran K V<sup>1\*</sup>, Abhinethra M S<sup>2</sup> and Sushma Rudraswamy<sup>3</sup>

<sup>1</sup>Doctor, Private Practitioner, Mysore, India.

<sup>2</sup>Reader, Department of Oral Medicine and Radiology, V S Dental College, (affiliated to Rajiv Gandhi University of Health Sciences) Bangalore, Karnataka, India.

<sup>3</sup>Assistant Professor, Department of Public Health Dentistry, JSS Dental College, JSSAHER, Mysore, Karnataka, India.

Received: 07 Jan 2024

Revised: 26 Mar 2024

Accepted: 26 Apr 2024

### \*Address for Correspondence

Aiswarya Chandran K V

Doctor,

Private Practitioner,

Mysore, India.

Email: aiswaryachandrank@gmail.com



This is an Open Access Journal / article distributed under the terms of the **Creative Commons Attribution License** (CC BY-NC-ND 3.0) which permits unrestricted use, distribution, and reproduction in any medium, provided the original work is properly cited. All rights reserved.

### ABSTRACT

Oral submucous fibrosis (OSMF) is a potentially malignant disorder affecting the oral cavity, pharynx, and upper digestive tract. It causes inflammation and fibrosis of submucosal tissues, with areca nut being the main agent. The nut's alkaloid and flavonoid components cause abnormal collagen production, leading to fibrous bands and reduced mouth opening. Prolonged chewing can also lead to oral cancer in OSMF patients. A study of 20 OSMF patients was conducted, who received biweekly intralesional injections of 1.5 ml Dexamethasone in 4 mg/1 ml and Hyaluronidase 1500 IU mixed with Lignocaine 0.5 ml& with flax seed oil capsules 1000mg three times for six weeks daily for three months. All the patients were followed up every month for 3 months and then after six months, and their mouth opening was assessed based on inter-incisal distance, tongue protrusion, cheek flexibility, and burning sensation. The study showed statistically significant improvements in mouth opening, cheek flexibility, and burning sensation, except tongue protrusion, but also clinically significant improvements in overall oral health. The study suggests that flaxseed oil capsules along with intralesional injections may be an effective treatment for Oral submucosal fibrosis patients, but further research is needed to confirm these findings.

**Keywords:** Oral Submucous Fibrosis, flaxseed oil, omega 3 fatty acids, Corticosteroid



Aiswarya Chandran *et al.*,

## INTRODUCTION

Oral submucous fibrosis (OSMF) is a chronic, resistant disease characterized by a juxta-epithelial inflammatory reaction and progressive fibrosis of submucosal tissues. It affects the oral cavity and pharynx, leading to rigidity, trismus, and difficulty opening the mouth. Other terms include juxta-epithelial fibrosis, idiopathic scleroderma, idiopathic palatal fibrosis, submucous fibrosis, sclerosing stomatitis, and diffuse OSMF. [1,2] The prevalence of OSMF in India is estimated to be between 0.2-2% in males and 1.2-4.6% in females, with a broad age range of 11-60 years. The widespread marketing of commercial tobacco and areca nut products, known as Gutkha, has led to a significant increase in incidence, affecting 10-20% of the global population.[3] Various treatment modalities have been attempted for this condition, including quitting smoking, medicinal therapy like iron supplements, multivitamins, antioxidants, intravenous injections, steroid injections, and placenta extracts. Severe cases require surgical excision of fibrous bands. Flaxseed oil, derived from flaxseed, is a rich source of essential omega-3 fatty acid alpha-linolenic acid (ALA), and is often used as a dietary supplement. It contains active compounds like ALA, LA, and oleic acid, as well as Fiber and ligans, glycosides, and peptides. Flaxseed oil has been shown to lower inflammation, prevent heart disease, and promote digestive health, with its lipid peroxidation playing a role in its benefits. Flaxseed oil has been touted as a potential remedy for reducing inflammation due to its high concentration of omega-3 fatty acids.[4] A meta-analysis of 12 studies found that flaxseed oil can reduce the levels of inflammatory markers Interleukin-6 and malondialdehyde.[5] Omega 3 fatty acids, Eicosapentanoic acid(EPA) and Docosahexaenoic acid (DHA), are polyunsaturated essential fatty acids that humans cannot synthesize. Studies have shown their beneficial effects on chronic inflammatory diseases like Rheumatoid arthritis, Systemic Lupus erythematosus, inflammatory bowel diseases, chronic periodontitis, and Recurrent aphthous stomatitis. They also show anti-inflammatory and antineoplastic activity with minimal side effects. However, their role in OSMF not been well established. [6,7,8] Till now no study has been conducted to evaluate the efficacy of flaxseed oil in OSMF.

## MATERIALS AND METHODS

The study involved 20 clinically diagnosed Oral Submucous Fibrosis patients at V.S Dental College and Hospital Bangalore, reporting to the Department of Oral Medicine and Radiology. The study includes patients aged 18 to 60, willing to participate and sign informed consent, with a positive history of areca nut chewing or commercial preparations, and those with clinically diagnosed oral submucous fibrosis, including difficulty opening the mouth, blanching, burning sensations, and palpable fibrous bands. Patients with other systemic diseases, mucosal diseases, skin lesions associated with oral lesions, and those with known allergies or contraindications are excluded from the study. A case history was recorded, and patients were informed about the procedures to be performed during the study. Patients were asked to sign a consent form if they were ready to participate. Mouth opening, tongue protrusion, cheek flexibility, and burning sensation were evaluated.

- Mouth opening was measured as the distance between the incisal edges of upper and lower central incisors when maximally extended.
- Tongue protrusion was measured as the distance from the mesio-incisal edge of central incisor to the tip of the protruded tongue.
- Cheek flexibility was recorded based on the distance between specified points on the cheek skin.
- Burning sensation was determined using a 0-10 Visual Analogue Scale (VAS), with higher scores indicating a greater level of burning sensation.

Patients were given biweekly intralesional injections of Dexamethasone 1.5ml & Hyaluronidase 1500 IU mixed with Lignocaine 0.5 ml for 6 weeks & with flax seed oil capsules 1000mg three times daily for 3 months. Patients were followed up every month for 3 months and then after 6 months. We have used Naturyz flaxseed oil soft gels offer 1000mg of flaxseed oil with an active form of Omega 3-6-9, providing essential fatty acids for body function. These





Aiswarya Chandran *et al.*,

soft gels are rich in phytonutrients, ALA (Alpha-linolenic acid), and fatty acids. The data was analysed using SPSS 22.0 (SPSS Inc., Chicago, IL), with a significance level of  $p < 0.05$ . Descriptive statistics were used to assess mean and standard deviation, and ONE WAY ANOVA and TUKEYS POST HOC TEST were used to fine-tune differences within the group.

## RESULTS

The mean age and gender distribution of participants enrolled in a study are important demographic characteristics that can impact the overall findings and conclusions. In this study, the mean age of participants was  $37.6 \pm 9.5$ , indicating a relatively young population. Additionally, the study had a higher proportion of male participants, with 85% male and 15% female.

### Mouth opening

The mean mouth opening of the patients during 1st visit, 1st month, 2nd month, 3rd month, 6th month were  $2.99 \pm 0.58$ ,  $3 \pm 0.61$ ,  $3.12 \pm 0.61$ ,  $3.43 \pm 0.61$ ,  $3.46 \pm 0.65$  respectively with statistically significant p-value of 0.02. The mean comparison by ANOVA and Bonferroni s correction showed that there was a statistically significant difference between the baseline and the subsequent visit ( $p < 0.05$ ). The mean difference between the 1st visit and 3rd month, 1st visit and 6th month follow up showed statistically significant ( $p > 0.05$ ) [Table-1]

### Tongue protrusion

The mean measurement of tongue protrusion during 1st visit, 1st month, 2nd month, 3rd month, 6th month were  $2.78 \pm 0.69$ ,  $2.93 \pm 0.72$ ,  $3.0 \pm 0.72$ ,  $3.2 \pm 0.72$ ,  $3.18 \pm 0.73$  respectively with a p value of 0.25. The multiple mean comparison by ANOVA and Bonferroni s correction showed that there was no statistically significant difference between the baseline and the subsequent visit ( $p > 0.05$ ). The mean difference between the all the visits showed no statistical significance ( $p > 0.05$ ) [Graph-1].

### Cheek flexibility

The mean measurement of cheek flexibility during 1st visit, 1st month, 2nd month, 3rd month, 6th month were  $0.81 \pm 0.2$ ,  $0.87 \pm 0.22$ ,  $0.9 \pm 0.22$ ,  $0.96 \pm 0.22$ ,  $0.97 \pm 0.23$  respectively with a statistically significant p value of 0.03. The multiple mean comparisons by ANOVA and Bonferroni s correction showed that there was a statistically significant difference between the baseline and the subsequent visit ( $p < 0.05$ ). The mean difference between the 1st visits and 3rd month, 1st visit and 6th month follow up showed statistically significant ( $p > 0.05$ )

### Burning sensation

The mean value of burning sensation in during 1st visit, 1st month, 2nd month, 3rd month, 6th month were  $6.67 \pm 1.12$ ,  $4.45 \pm 1.31$ ,  $3.2 \pm 1.28$ ,  $2.05 \pm 1.31$ ,  $1.35 \pm 1.3$  with a highly significant p value of 0.0001. The multiple mean comparisons by ANOVA and Bonferroni s correction showed that there was a statistically significant difference between the baseline and the subsequent visit ( $p < 0.05$ ). The mean difference between the all the visits showed statistical significance ( $p < 0.05$ ) except between 3rd and 6th month.

## DISCUSSION

The study enrolled 20 patients with a history of areca nut chewing or commercial preparations, and those clinically diagnosed with oral submucous fibrosis. Most of the subjects were in the age range of 24-65, with 85% being male and 15% female. The clinical presentation of the patients included difficulty opening the mouth, blanching, burning sensations, and palpable fibrous bands. Most subjects belonged to functional stage 1 and clinical stage 2 category in our study<sup>9</sup>. These findings suggest that areca nut chewing, and commercial preparations are more prevalent in males and can lead to the development of oral submucous fibrosis. The study highlights the importance of early diagnosis





**Aiswarya Chandran et al.,**

and intervention to prevent the progression of the disease to more advanced stages. The study educated patients about their condition and its potential, instructed them to stop all forms of habit, and provided detailed information about all procedures performed. Informed consent was obtained, including the patient's history, form, type, frequency, and duration. Flaxseed oil is a great source of heart-healthy omega-3 fatty acids, with one tablespoon containing a substantial amount of 7,196 mg. However, it is important to note that the omega-3 fatty acid found in flaxseed oil, alpha-linolenic acid (ALA), is not converted efficiently to active forms of omega-3 like EPA and DHA.[10] A study in Pune, Maharashtra, evaluated the effectiveness of systemic Omega-3 in treating OSMF patients. Patients received biweekly intralesional injections of Dexamethasone and Hyaluronidase mixed with Lignocaine for 6 weeks, and 1gm Omega-3 capsules three times daily for 3 months. The study concluded that Omega-3 fatty acids can reduce subjective symptoms.[6] Omega 3 fatty acids have been known to have numerous health benefits, including reducing inflammation and improving heart health. However, recent studies have shown that omega 3 supplementation can also have positive effects on oral health. A study has shown that a daily omega-3 regimen therapy for recurrent aphthous stomatitis patients has promising results. The therapy, which includes EPA and DHA, alters the cellular functions of polymorphonuclear leukocytes, modulates lymphocyte proliferation, and increases the expression of endogenous host antioxidant enzymes. This enhances inflammation clearance within the lesion, promoting tissue regeneration, and promotes the treatment of recurrent aphthous stomatitis.[11]

One more found that omega 3 fatty acids, specifically n-3 PUFA, EPA, and DHA, selectively inhibit the growth of both premalignant and malignant keratinocytes.[12] In OSMF, dexamethasone works as an immune suppressant by limiting soluble substances generated by sensitized lymphocytes and muzzling inflammatory responses, hence avoiding fibrosis by lowering fibroblastic proliferation and collagen deposition. Hyaluronidase degrades hyaluronic acid, reducing intercellular cement material viscosity and facilitating medication diffusion, leading in improved trismus and fibrosis outcomes.[13] These results suggest that flaxseed oil supplementation can have a positive effect on various oral health parameters, including mouth opening, cheek flexibility, and burning sensation. While the increase in tongue protrusion was not found to be statistically significant, it is possible that a larger sample size or longer duration of supplementation may yield different results. The present study analysed patients' mouth opening, tongue protrusion, cheek flexibility, and burning sensation during various visits. The mean mouth openings were measured at the first, second, third, and sixth months, with a statistical significant difference between the baseline and the subsequent visit ( $p < 0.05$ ). The mean difference between the 1st visit and 3rd month, 1st visit and 6th month follow up showed statistically significant ( $p > 0.05$ ). Tongue protrusion measurements were also measured at the first, second, third, and sixth months but there was no statistical significant difference between the baseline and the subsequent visit ( $p > 0.05$ ). The cheek flexibility at various intervals, with statistical significant difference between the baseline and the subsequent visit ( $p < 0.05$ ). The mean difference between the 1st visit and 3rd month, 1st visit and 6th month follow up showed statistically significant ( $p > 0.05$ ). Burning sensation were measured at the first, second, third, and sixth months, with a statistical significant difference between the baseline and the subsequent visit ( $p < 0.05$ ). The mean difference between the all the visits showed statistical significance ( $p < 0.05$ ) except between 3rd and 6th month. The results of this study suggest that the combination of intralesional injections and flaxseed oil capsules may be an effective treatment option for OSMF patients. However, studies with larger sample sizes and longer follow-up periods are needed to confirm these findings. Further research is needed to confirm these findings and to develop effective and safe treatments for this debilitating condition. It is important for patients with OSMF to seek early diagnosis and treatment to prevent the progression of the disease and reduce the risk of developing oral cancer.

## ACKNOWLEDGEMENTS

The authors express their sincere gratitude to VS Dental College and Hospital, Bengaluru, for their invaluable support and contributions to this research.





Aiswarya Chandran et al.,

## REFERENCES

1. Prabhu SR, Wilson DF, Daftary DK, Johnson NW. Oral Diseases in the Tropics. New York, Toronto: Oxford University Press; 1993. p. 417-22.
2. More C, Peter R, Nishma G, Chen Y, Rao N. Association of Candida species with Oral submucous fibrosis and Oral leukoplakia: a case control study. Ann Clin Lab Res. 2018;06(3):248. doi: 10.21767/2386-5180.100248.
3. Shahid RA. Coming to America: betel nut and oral submucous fibrosis. JADA. 2010;141:423e428.(1)
4. Goyal A, Sharma V, Upadhyay N, Gill S, Sihag M. Flax and flaxseed oil: an ancient medicine & modern functional food. J Food Sci Technol. 2014;51(9):1633-53. doi:10.1007/s13197-013-1247-9
5. Tamtaji OR, Milajerdi A, Reiner Ž, et al. Effects of flaxseed oil supplementation on biomarkers of inflammation and oxidative stress in patients with metabolic syndrome and related disorders: A systematic review and meta-analysis of randomized controlled trials. Clin Nutr ESPEN. 2020;40:27-33. doi:10.1016/j.clnesp.2020.09.017
6. Dr. Milanjeet Kaur Raizada, Dr. Digamber M Sable, Dr Asha Chowdhery, Dr.Mahesh Shivaji Chavan & Dr. Ladu Singh Rajpurohit. omega 3: a novel treatment agent in oral submucous fibrosis: a pilot study: J Oral Pathol Med. 2017 Jul;46(6):439-442.
7. Elham Rajaei, Karim Mowla, Ali Ghorbani, Sara Bahadoram, Mohammad Bahadoram& Mehrdad Dargahi-Malamir. The Effect of Omega-3 Fatty Acids in Patients With Active 59 Rheumatoid Arthritis Receiving DMARDs Therapy: Double-Blind Randomized Controlled Trial: Global Journal of Health Science 2016; (8) 7
8. Nosratzahi T, Akar A Efficacy of Omega-3 in Treatment of Recurrent Aphthous Stomatitis: A Randomised, Double-blind, Placebo-controlled Study: Chin J Dent Res 2016;19(3):159-64
9. Haider SM, Merchant AT, Fikree FF, Rahbar MH. Clinical and functional staging of oral submucous fibrosis. Br J Oral Maxillofac Sur. 2000;38:12-5.
10. Brenna JT. Efficiency of conversion of  $\alpha$ -linolenic acid to long chain n-3 fatty acids in man. Current Opinion in Clinical Nutrition and Metabolic Care [Internet]. 2002 Mar 1;5(2):127–32. Available from: <https://doi.org/10.1097/00075197-200203000-00002>
11. Khouli AE and Gendy EA. Efficacy of omega-3 in treatment of recurrent aphthous stomatitis and improvement of quality of life: a randomized, double-blind, placebocontrolled study. OOOOE. 2014; 117 (2):191-196.
12. Nikolakopoulou Z, Nteliopoulos G, Michael-Titus AT and Parkinson EK. Omega-3 polyunsaturated fatty acids selectively inhibit growth in neoplastic oral keratinocytes by differentially activating ERK1/2. Carcinogenesis. 2013; 34(12):2716–2725.
13. Leena James , Akshay Shetty , Diljith Rishi, Marin Abraham . Management of Oral Submucous Fibrosis with Injection of Hyaluronidase and Dexamethasone in Grade III Oral Submucous Fibrosis: A Retrospective Study. Journal of International Oral Health 2015; 7(8):82-85.

Table 1- Analysis at different time interval

	MOUTH OPENING		TONGUE PROTRUSION		CHEEK FLEXIBILITY		VAS FOR BURNING SENSATION	
	MEAN	SD	MEAN	SD	MEAN	SD	MEAN	SD
1 <sup>st</sup> visit	2.99	0.589	2.78	0.697	0.81	0.2	6.67	1.182
1 <sup>st</sup> month	3.09	0.61	2.93	0.725	0.87	0.225	4.45	1.316
2 <sup>nd</sup> month	3.12	0.611	3.07	0.734	0.90	0.228	3.2	1.281
3 <sup>rd</sup> month	3.43	0.612	3.205	0.721	0.96	0.225		







**Aiswarya Chandran et al.,**

							2.05	1.316
6 th month	3.46	0.659	3.185	0.738	0.97	0.234	1.35	1.308
F VALUE	3.18	1.35	2.66	68.61				
P VALUE	<b>0.02*</b>	0.25	<b>0.03*</b>	<b>0.0001*</b>				
POSTHOC TEST(TUKEY HSD TEST)	P VALUE	PVALUE	P VALUE	P VALUE				
1 <sup>ST</sup> VISIT & 1 <sup>ST</sup> MONTH	0.95	0.96	0.98	<b>0.0001*</b>				
1 <sup>ST</sup> VISIT & 2 <sup>ND</sup> MONTH	0.12	0.70	0.34	<b>0.0001*</b>				
1 <sup>ST</sup> VISIT & 3 <sup>RD</sup> MONTH	<b>0.02*</b>	0.35	<b>0.03*</b>	<b>0.0001*</b>				
1 <sup>ST</sup> VISIT & 6 <sup>TH</sup> MONTH	<b>0.02*</b>	0.40	<b>0.02*</b>	<b>0.0001*</b>				
1 <sup>ST</sup> MONTH& 2 <sup>ND</sup> MONTH	0.15	0.97	0.41	<b>0.012*</b>				
1 <sup>ST</sup> MONTH& 3 <sup>RD</sup> MONTH	0.11	0.75	0.06	<b>0.0001*</b>				
1 <sup>ST</sup> MONTH& 6 <sup>TH</sup> MONTH	0.44	0.80	0.11	<b>0.0001*</b>				
2 <sup>ND</sup> MONTH& 3 <sup>RD</sup> MONTH	0.31	0.97	0.87	<b>0.04*</b>				
2 <sup>ND</sup> MONTH& 6 <sup>TH</sup> MONTH	0.26	0.98	0.80	<b>0.0001*</b>				
3 <sup>RD</sup> MONTH& 6 <sup>TH</sup> MONTH	0.99	0.98	0.99	0.41				

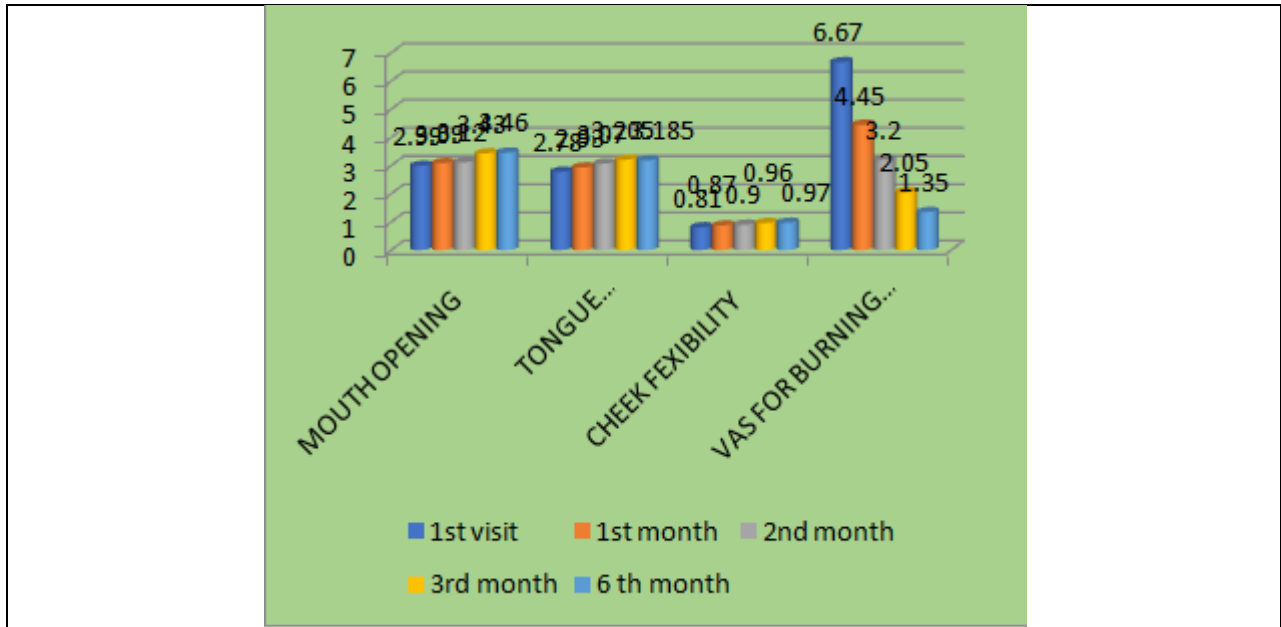
\*P<0.05 is statistically significant(ANOVA TEST)

Analysis within the each visit using ANOVA shows significant difference exist observed with respect to mouth opening, cheek flexibility and VAS burning sensation (p<0.05)





Aiswarya Chandran et al.,



Graph 1: Graphical representation at different time interval





## Role of Kukutanda Pinda Sweda and Mashbaladi Nasapana in the Management of Ardita W.S.R to Bell's Palsy - A Case Study

Alka Yadav<sup>1\*</sup> and Sarita Yadav<sup>2</sup>

<sup>1</sup>Assistant Professor, Department of Panchakarma, FIMS, SGT University, Gurgaon, Haryana-122004, India.

<sup>2</sup>Assistant Professor, Department of Shalaky Tantra, FIMS, SGT University, Gurgaon, Haryana-122003, India.

Received: 22 Jan 2024

Revised: 09 Feb 2024

Accepted: 29 Apr 2024

### \*Address for Correspondence

**Alka Yadav**

Assistant Professor,  
Department of Panchakarma,  
FIMS, SGT University,  
Gurgaon, Haryana-122004, India.  
Email: raoalka2324@gmail.com



This is an Open Access Journal / article distributed under the terms of the **Creative Commons Attribution License** (CC BY-NC-ND 3.0) which permits unrestricted use, distribution, and reproduction in any medium, provided the original work is properly cited. All rights reserved.

### ABSTRACT

*Ardita* disease is one of the eighty *Nanatmaja Vyadhi* of *Vata* caused by vitiated *Vata* which affects the face unilaterally leading to deviation of the face, slurred speech, unable to blink or close the affected eye. As per *Acharya Charak* this disease may affect half the body or half of the face only, when half of the face is involved then it is called *Ardita*. *Ardita* can be correlated with bell's palsy. Bell's palsy is most common unilateral lower motor neuron facial palsy that suddenly or progressively occur that results in a temporary inability to control the facial muscles on the affected side of the face. In most cases, the weakness is temporary and significantly improves over weeks. Symptoms can vary from mild to severe. A 42-year-old male patient came to Panchakarma OPD in SGT Ayurveda hospital with complaints of left side deviated face, drooling of saliva from the left angle of mouth, slurred speech and unable to close his right eye. The patient was treated with Panchakarma procedures (*Kukutanda Pinda Sweda* and *Mashbladi Nasapana*) along with palliative *Ayurvedic* (*Shamana* medicine) treatment. After the treatment patient got significant relief in the symptoms. Bell's palsy can be managed inclusively with *Panchakarma* procedure and *Shamana* medicine (palliative treatment).

**Keywords:** *Ardita*, *Kukutanda Pinda Sweda*, *Mashbaladi Nasapana*, Bell's Palsy.





Alka Yadav and Sarita Yadav

## INTRODUCTION

Bell's palsy is an acute infranuclear lower motor neuron type palsy of seventh cranial nerve involving all the muscles of face resulting in weakness of the facial muscles. The lesion in bell's palsy is nonsuppurative inflammation or edema of the nerve at the level of stylomastoid foramen [1]. It accounts for over 50% of acute facial palsies. Bell's palsy equally affects both sexes. There is no age bar but incidence rises with increasing age [2]. Bell's palsy has an incidence of 23 cases per 100,000 population/year, or about 1 in 60 to 70 people in a lifetime [3]. In *Ayurvedic* literature Acharya Charka explained *Ardita* as "*ArdhēTasminmukhārdhē Vā Kēvalē Syāttadarditam*" means when increased *Vata* and *Rakta Kshaya* affects one half of the body or half of the face only, is called *Ardita* (facial paralysis) leading to distortion of one side of the face and produces asymmetry of the nose, eye brow, fore head, eye and jaw[4]. In *Ashtang sangraha* *Ardita* explained as *Ekayama*.

### Chief Complaints

A 42 years old male patient comes to Panchakarma OPD. Patient came with following chief complaints:

1. *Vakri bhavti vaktrardha* (Deviation of the mouth on left side)
2. *Netra stabhdta* (Difficulty in closing the right eye) for two weeks
3. *Netra strava* (watering of the eye)for two weeks
4. *Lalastrava* (Drooling of saliva on right angle of mouth)
5. Unable to chew food
6. *Swarbheda* (Slurred speech)

### History of Present illness

A 42 years old male patient was asymptomatic before 2 weeks but in the morning when he woke up; observed right sided facial weakness and gradually in the evening condition worsened. He was suffering from symptoms like asymmetry of the face, difficulty in closing right eye with dribbling of saliva from the angle of the mouth on the left side of the face.

### History of Past illness

**Medical history-** K/C/O HTN for 2 years (taking antihypertensive drug) Appendectomy 3 years before

**Diagnostic history-** MRI Bain (2/10/2023)- Showed long segments of the facial nerve enhance in a uniformly linear fashion on right side

### Personal History-

Marital status-Married

Occupation- Software Engineer

Diet- Vegetarian

Sleep- Disturbed due to work

**Family History:** No any major illness

### On Examination

General physical examination –

Weight- 69kg

Height-5'3"

BMI-26.9 kg/m<sup>2</sup>

Blood pressure- 130/90 mm of hg

Pulse- 74/min.

Respiration rate- 16/min



**Alka Yadav and Sarita Yadav**

Pallor- Absent  
Icterus- Absent  
Cyanosis- Absent  
Clubbing- Absent  
Oedema- Absent  
Lymphadenopathy- Absent

**Asthavidh Pariksha**

- Nadi - 74/min.
- Mala - Samyak
- Mutra - Samyaka
- JIvha - Niram
- Shabda - Avishesha
- Sparsha - Ruksha
- Druka - Avishesha
- Akruti – Madhyam

**On Systemic Examination**

Examinations of Respiratory system and Cardiovascular, observed no significant abnormality.

Central Nervous Examination-

1. Consciousness- Conscious
2. Orientation to- Time, place, person- Intact
3. Memory - not affected
4. Intelligence- Intact
5. Hallucination & Delusion - Absent
6. Speech - Slow and slurred

Superficial and deep reflexes were normal.

**Cranial nerve examination-**

On examination the function of all cranial nerves is intact except facial nerve.

**Sensory assessment**

Taste sensation- intact

Hearing function- intact

Motor assessment-

Hearing function-Normal

**Inspection**

a. Symmetry of face- Asymmetrical, Deviation of mouth towards left side

**Facial movement**

Asked the patient to carry out a sequence of **facial expression**.

- **Eyebrows raising:** to assesses frontalis – not possible on right side
- **Forehead frowning:** to assesses frontalis- not possible on right side
- **Closures of eyes:** to assesses orbicular oculi – Right eyeball moves upwards and inwards when the patient attempts to close it along with incomplete closure of eyelid. (Bells phenomenon)
- **Blowing of cheeks:** to assesses orbicularis oris –not Possible in right side





### Alka Yadav and Sarita Yadav

- **Smiling sign:** to assesses levator anguli oris and zygomaticus major – present but without upward involvement of right angle of mouth
- **Pursed lips:** to assesses orbicularis oris and buccinator – not possible on the right side.

#### Treatment plan

##### **Panchakarma (bio purification) procedures**

Assessment was done on the basis of facial nerve function grading by House-Brookman grading measures[5].

The case study was assessed after administering seven days of Abhyanga with *Navaneeta* and localised *Swedana* by *Kukutanda Sweda* followed by *Mashbaladi Nasapana* and *Vachadi Pratisarana* [Table no.1] for seven days. Significant relief was observed in closure of the eyelids, nasolabial fold and improvement was noticed in weakness of different facial muscles, and complete pursing of lips. There was significant improvement observed in speech and drooling of saliva but mild asymmetry of the face was present for *Shamana* of *Doshas*, the same medications were continued for two more weeks. [Table no.2]

## DISCUSSION

*Ardita* is a *Vata* dominant disorder and in *Ayurvedic* classical texts there are different treatment modalities are mentioned like *Navana* (Errhine therapy), *Moordha Taila* like *Shirobasti* (retention of oil on the head), *Tarpana* (Libation) with medicated oil to the eyes and ears, *Nadi Sweda* (Tubal sudation), *Upanaha Sweda* (application of poultice) are included in the treatment principle of *Ardita*. Keeping in the view of all treatment modalities mentioned in our classical texts, this comprehensive treatment was planned for the patient.

##### **Kukutanda Pinda Sweda**

*Kukutanda Pinda Sweda* or *Anda Sweda* is practiced mainly by *Ayurveda Vaidya* in Kerala. It comes under the variety of *Ushma sweda*[6].

##### **Mashabaladi Nasapana**

The word *Nasapana*, which means drinking of medicated ghee, oil or decoction through nose. Yoga science also advocated to drink water through nose for cleansing the upper respiratory tract and the technique is called as *Jala Neti*.<sup>7</sup> *Acharya Videha* is the first to mention the *Nasapana*[8].

##### **Mashbaladi Kshaya**

*Māṣabalāśūkasimbikatrīnarāsnā'svagandhoruvūkānām |*

*koātho nasyanipito ramathalavanānvitah koṣṇah ||*

*apaharati pakṣaḡhatam manyāstambham sakarṇanādarujam durjayamarditavatam saptahajjayati cavasyam || (CD 72)*

*Mashbaladi nasapana* is mentioned in the *Chakradutta* and indicated in paralysis, neck rigidity, tinnitus and facial paralysis for seven days [9]

## PROCEDURE

After *Abhyanga* with *Navneet* and *Swedana* with *Kukutanda Pinda Sweda*, the patient was made to sit on *Nasaya* chair and head of the patient was kept tilted laterally. Then *Sukhoshana Mashbaladi Kashaya* is filled in 20 ml syringe and pushed slowly into the nostril. The same procedure was done for other nostril also. During the procedure patient was asked to swallow the contents as much as possible. After that *Gandoosha* and *Kavala graha* followed. The patient was advised to take *Sukhoshna Jala* and *Laghu Ahara*.

**Ekangveer Ras-** It balance the vitiated *Vata* and *Kapha* and also have rejuvenating and nourishing properties[10].





### Alka Yadav and Sarita Yadav

**Ashwagandha Churna**-It reduces increased *Vata* and *Kapha* and cures oedema[11].

**Shatavari Curra**-Improves muscle tone, and cures aggravated *Vata*, *Pitta*, *Rakta* and oedema [12].

**Dashmoola Kwatha**-*Dashmoola* has potent anti-inflammatory and antioxidant properties. As a result, it's utilised to treat painful, inflammatory conditions [13].

#### **Mukhabhyanga with Navneet**

Facial massage done with *Navneet* –*Navaneeta* is said to be an *Agyadravya* (main drug) for *Arditavata* by *Acharya Vagbhata* [14]. It is *Snigdha* and *Madhura* in *rasa* and has *Vatapittahara* properties[15].

**Kukatanda Pinda Sweda**- It is *Snigdha*, lipid soluble liquid and it provides *Snehana* and *Swedana* simultaneously. The massage with the *pottali* increased localised circulation. *Kukatanda* in itself has *brahmana* and *snigdha*, *balaya* properties as egg yolk contains high amount of vitamin A,D,E,B1,B2,B5,B6,B9 and B12 and choline which helps in the improvement the of muscle and nerve fibers and increase the flexibility of facial muscles[16].

**Nasapana** -Most of the drugs used in the *Mashabladi Nasapana* are either *Kaphavata Shamaka* or *Vata Shamaka* some of the drugs are *teekshana* such as *Hingu*, *Saindhava*. They produce irritation of the nasal mucosa which increases the nasal secretions as a result of increased circulation. It also probably generates a chemical impulse which is further transformed into electrical impulse which is finally converted into a neuronal impulse. This neuronal impulse influences on cerebral cortical areas thereby producing a stimulatory effect leading to evacuation of dosha and stimulation of facial nerve. Also, the irritant effect of *Nasapana dravya* increases blood circulation to the brain, which increase oxygen supply which reduces Ischemia, which is one of the reasons for facial paralysis. Ultimately the morbid dosha are thrown out along the nasal discharge, tears and saliva. Also, the *vatashamaka* drugs and *brumhaniya* drugs allieviate *vata*. Hence this preparation is effective in both *Dhatuksajanya* and *Margavaranjanya Vata Vyadhis*. The active principles may reach upto certain levels in nervous system to produce *vatagna* effect and *bala*, *mashabring brunhana* effect i.e., regeneration of the tissues and innervation of facial nerve. In this way *Nasapana* helps in management of *Ardita* [17].

## CONCLUSION

The case was treated with comprehensive panchakarma treatment modalities like *abhyanga*, *kukatanda pinda sweda* and *Mashabladi nasapana* along with palliative treatment. This treatment was helpful in reducing symptoms of bell's palsy by balancing vitiated *vata dosha* by *snehana*, *vatashamaka*, *brumhaniya*, anti-inflammatory properties of drugs used in treatment. This current study provides a way more to explore the scope of therapy like *nasapana* in motor neuron disorders.

## REFERENCES

1. Dr. SN Chug, Bedside Medicine Without Tears, Published by Jaypee Brothers, 2<sup>nd</sup> Edition, 2011, page no. 229
2. PL Dhingra, Shruti Dhingra, Diseases of Ear, Nose and Throat, Published by Elsevier, 6<sup>th</sup> Edition, Chapter 14, page no. 95
3. M. Flint Beal, Stephen L. Hauser, Harrison's Internal Medicine, Trigeminal Neuralgia, Bell's Palsy, and Other Cranial Nerve Disorders, part 16, 17<sup>th</sup> ed., p. 2584.
4. Vatavyadhi Chikitsa (carakasamhitaonline.com)
5. House-Brackmann score [https://en.wikipedia.org/wiki/House%E2%80%93Brackmann\\_score](https://en.wikipedia.org/wiki/House%E2%80%93Brackmann_score)
6. Dr. Vasant C. Patil, Principles and Practice of Panchakarma, Chapter 14, page no.559, Chaukhamba Publications 2016, ISBN: 9788191028607
7. Dr. Vasant C. Patil, Principles and Practice of Panchakarma, Chapter 14, page no.559, Chaukhamba Publications 2016, ISBN: 9788191028607





## Alka Yadav and Sarita Yadav

8. Dr. Vasant C. Patil, Principles and Practice of Panchakarma, Chapter 14, page no.559, Chaukhamba Publications 2016, ISBN: 9788191028607
9. Chakrapanidatta, Cakradatta- Chikitsa Sangra, translated by Ravidatta shastri chapter 22, vatavyadhi, verse no. 24, Chaukhamba Publishers; Varanasi
10. <http://ayurmedinfo.com/2012/07/10/ekangveer-rasbenefits-dosage-ingredients-side-effects>.
11. Bhavprakash of Bhavamisra, Commentary by Dr. Bulusu Sitaram, Gudichyadai Varga page no. 278 Chaukhamba Publishers; Varanasi
12. Bhavprakash of Bhavamisra, Commentary by Dr. Bulusu Sitaram, Gudichyadai Varga page no. 278 Chaukhamba Publishers; Varanasi
13. [https://www.researchgate.net/publication/360354715\\_dashamoola\\_a\\_systematic\\_overview](https://www.researchgate.net/publication/360354715_dashamoola_a_systematic_overview)
14. Bramhananda T, editor. Uttara Tantra; Chapter 40, verse no. 15. In: Astanga Hridaya of Vagbhata with Nirmala Hindi Commentary. Varanasi, India: Chaukhamba Sanskrit Pratisthana; 2013. p. 1212
15. Kashinath SP, Gorakhnath C, editors. Sutra Sthana; Chapter 27, verse no. 230. In: Charak Samhita of Agnivesha with Vidyotini Hindi Commentary. Varanasi, India: Chaukhamba Surabharati Prakashana; 2008. p. 552
16. Sophie Rehault-Godbert, Nicolas Guyot, Yves. The Golden Egg: Nutritional Value, Bioactivities, and Emerging Benefits for Human Health. Nutrients. 2019;11: 684p. doi:10.3390/nu11030684.
17. Dr. Unnikrishnan. V. S, Dr. Prashanth. A. S., Dr. Priyadarshini, A Critical Review On The Concept Of Nasapana And Its Mode Of Action. Pijar/July-August-17/Volume 1/Issue-6 Page 71

Table no.1: Panchakarma (bio purification) procedures

SN	Panchakarma procedures	Drugs	Duration
1.	Mukha abhyaga (Facial massage)	Navneet	7 Days
2.	Swedana	Kukutanada sweda	7 Days
3.	Nasapana	Mashbaladi kwatha	7 Days
4.	Jihwa pratisarana	Vacha, yastimadhu pratisarana with honey	7 Days

Table no. 2 Palliative Treatment

SN	Medicines	Duration
1	Ekangveer ras- one tablet twice a day with luke warm water	14Days
2	Ashwagandha churna- 3gm twice a day with luke warm water	14 Days
3	Shatavari churna- 2 gm twice a day with luke warm water	14 Days
4	Dashmoola kwatha- 15 ml twice a day with luke warm water before meal	14Days

Table no. 3 Table of comparisons of subjective parameters

Parameters	Grading before treatment	Grading after 7 days of treatment	Grading after 14 days
Forehead frowning	Absent	Moderately visible	Clearly visible
Deviation of the mouth toward left side	Grade iii	Grade ii, slightly deviated	Deviation decreased by 80%, turning to normal symmetry of face
Improper blinking of right eye	Grade iii	Grade ii	Blink and close eye easily
Unable to chew food from right side	Grade iv	Grade ii, able to chew semisolid food	Able to chew solid food properly from right side
Slurred speech	Very slow and highly muffled	Able to speak with less efforts and moderately muffled voice	Mild muffled voice
Dribbling of saliva from the angle of	Spontaneous	Intermittent dribbling	Dribbling of saliva controlled completely







## Alka Yadav and Sarita Yadav

mouth			
Widening of palpebral fissure	Severely wide (half of the cornea and sclera visible)	Moderately wide (one third of cornea and sclera visible)	Slightly wide (clearly visible cornea)
Nasolabial fold	Nasolabial crease absent	Nasolabial crease seen slightly while smiling	Clearly visible nasolabial crease
Pursing of lips	Release of air while pursing	With efforts able to purse the lips without release of air	Complete pursing of lips without release of air
Smiling sign	Present without upward involvement	Mild upward involvement	Marked upward movement

Table 4- contents of the *Kukutanda pinda sweda*

SN	Drugs	Quantity
1.	<i>Kola-kulatthadi churna</i>	400gms
2.	<i>Haridra</i>	100gms
3.	<i>Methika</i>	100gms
4.	Lemon	1
5.	Egg yolk	10
6.	Cloth	2meter
7.	Thread	2meter
8.	Dashmoola oil	500ml

Table 5- Contents of *Mashabaladi Kashaya*

SN	Drugs	Quantity
1.	<i>Masha</i> ( <i>Vigna radiata</i> )	10gms
2.	<i>Bala</i> ( <i>Sida cordifolia</i> )	10gms
3.	<i>Shookashimbi</i> ( <i>Mucuna pruriens</i> )	10gms
4.	<i>Rasana</i> ( <i>Pluchea lanceolata</i> )	10gms
5.	<i>Ashwagandha</i> ( <i>Withania somnifera</i> )	10gms
6.	<i>Urubaka</i> ( <i>Ricinus cummunis</i> )	10gms
7.	<i>Hingu</i> ( <i>Asafoetida</i> )	1 pinch
8.	<i>Saindhav</i>	1 pinch





## Influence of using Microalgae as Biofertilizer in Wheatgrass (*Triticum aestivum*)

Khevna Pandya<sup>1</sup>, Vijay Jagdish Upadhye<sup>2</sup> and Anupama Shrivastav<sup>3\*</sup>

<sup>1</sup>Ph.D. Scholar, Department of Microbiology, Faculty of Applied Science, Parul University, Vadodara, Gujarat, India.

<sup>2</sup>Deputy Director, Department of Research and Development cell, Parul University, Vadodara, Gujarat, India.

<sup>3</sup>Associate Professor, Faculty of Life Health and Allied Sciences, ITM Vocational University, Vadodara, Gujarat, India-391760.

Received: 22 Jan 2024

Revised: 09 Feb 2024

Accepted: 27 Apr 2024

### \*Address for Correspondence

**Anupama Shrivastav**

Associate Professor,

ITM Vocational University,

Gujarat, India.

Email: anupamashrivastav@gmail.com



This is an Open Access Journal / article distributed under the terms of the **Creative Commons Attribution License** (CC BY-NC-ND 3.0) which permits unrestricted use, distribution, and reproduction in any medium, provided the original work is properly cited. All rights reserved.

### ABSTRACT

Biofertilizers play an essential role as an additional substance supplied to crops to increase their productivity. The production of crops and their market value are significantly influenced by fertilizers. Therefore, broad-spectrum, low-cost biofertilizers must be produced on a large scale. In this study, the impact of freshwater microalgae as fertilizer on wheatgrass (*Triticum aestivum*) growth and yield was examined. The wheatgrass plant was grown in soil that also contained cow manure and microalgae (*Micractinium reisseri*) and another wheatgrass plant without microalgae species (control). Different growth parameters, viz., plant height, number of leaves per plant, fresh weight, dry weight of leaves, and pigment content, were examined. The result shows that plants treated with microalgae were found to have all growth parameters and pigment content higher than the control plant. In addition, the microalgae-treated plant increased its growth performance at the early stage of growth, improved its yield characteristics, and increased seed germination. The potential of the microalgae as fertilizer in the production of wheatgrass was demonstrated by a microalgae treatment that showed high growth and yield.

**Keywords:** Biofertilizer, Microalgae, *Micractinium reisseri*, *Triticum aestivum*





Khevna Pandya et al.,

## INTRODUCTION

Freshwater and marine habitats both include microscopic photosynthetic organisms called microalgae. They have a similar photosynthetic process as land plants, but because they live in an aqueous environment with abundant water, CO<sub>2</sub>, and other essential nutrients, they are far more effective at turning solar energy into biomass [1]. They are an incredibly diverse group of prokaryotic and eukaryotic organisms, and because they are less well known, they can be used to make organic slow-release fertilizer [2, 3]. Because of their commercial importance as a source of high-content proteins, vitamins, vital amino acids, and fatty acids, microalgae are photosynthetic organisms that are regarded as essential biofertilizers. The use of enriched organic biofertilizers is highly advantageous in order to increase yield both quantitatively and qualitatively, rather than applying organic fertilizers alone [4]. As an organic fertilizer that provides N, P, and K in a steady release for the needs of plants, microalgae have the ability to stop nutrient losses. In addition to macronutrients, the phototrophic microorganisms also include trace elements and compounds that help plants thrive, such as phytohormones, vitamins, carotenoids, amino acids, and antifungal agents [5]. For cyanobacteria, anoxygenic phototrophic bacteria, and microalgae, the advantageous properties of phototrophic biomass as a biofertilizer, such as bioactive growth-promoting supplements, have already been established [6, 7]. Only biofertilizers have the capacity to convert essential nutrients from inaccessible to available forms during biological processes and to provide optimal conditions for growth and germination [8]. Agriculturally significant microalgae are a source of biofertilizers, mostly for tropical rice and wheat crops.

Additionally, algae produce bioactive substances (secondary metabolites) that promote the growth of some plant species and prevent the growth of harmful bacteria and fungi. Additionally, the microalgae supply organic matter for plant growth [9, 10, 11]. A potential remedy is the use of microalgae as biofertilizers. Biofertilizers are viewed as a sustainable, cost-effective, and environmentally friendly alternative to synthetic fertilizers because they not only increase agricultural production but also reduce environmental pollution [12]. Biofertilizers are substances that contain living microorganisms or natural substances derived from organisms like bacteria, fungi, and algae that enhance the chemical and biological qualities of soil, promote plant development, and restore soil fertility [13]. Faster germination and better growth of rice seeds have been discovered in a study looking at the impact of algal extracts on seed germination [14]. Similar outcomes were found by other, more recent research using seaweed extracts on tomato and wheat seedlings; however, they also noted growth inhibition with increasing extract concentrations [15, 16, 17]. It is noted that when compared to using the appropriate N completely via inorganic form or using inorganic N form at percentages lower than 50%, using the *S. platensis* biofertilizer from 5 to 25 ml/tree/year resulted in a significant promotion on the leaf area and its content of N, P, and K, yield, and fruit quality [18]. The impact of algal biofertilizers such as *C. vulgaris* and *S. platensis* was clearly seen in the plant growth parameters, yield production, seed quality, seed germination, and physical chemical parameters of rice and maize [19, 20]. Earlier, it was observed how *C. vulgaris*, an organic fertilizer, affected the development and productivity of grapevines, banana trees, and lettuce [21, 22]. Investigating the potential agricultural uses of the hardy green microalgae *Micractinium reisseri* as a seed primer, a foliar fertilizer, and a soil amendment or biofertilizer was the aim of this study. It also sought to determine its effects on wheatgrass (*Triticum aestivum*) seed germination and plant growth.

## MATERIALS AND METHODS

### Algal culture.

The freshwater microalgae culture maintained in the microbiology laboratory of Parul Institute of Applied Sciences and Research, Parul University, Ahmedabad, Gujarat, India, was used in this study. BG-11 medium and Bold Basal Medium (BBM) were used for the growth of *M. reisseri*. Both cultures were incubated under continuous illumination at room temperature. Mass cultivation of microalgae was performed with an aerator set up. Microalgae was dried in a hot air oven, and the dried biomass of algae was harvested.





Khevna Pandya et al.,

### Experimental setup

The experiment was conducted for 25 days, and the experimental design is shown in Fig. 1. Wheat grass seeds were surface-sterilised with 70% ethanol and washed with distilled water, then air-dried in the shadow of open air. The seeds were planted in 10 cm-diameter earthen pots containing sandy loam soil with 50% coarse sand, 4% fine sand, 20% silt, and 15% clay with a pH of 7.2. Soil was treated with cow dung manure and microalgae at a dose of 2 g dry power per kg of soil before planting. A fully randomized design with the following three treatments in triplet replicates was set up for growing in natural environmental conditions. Every treatment received 15 seeds to sprout, and they were watered twice weekly. The number of leaves, length of leaves, and width of leaves were recorded at a specific time interval. Treatments are as follows:

1. Control
2. Microalgae

### Growth Parameters

#### Plant height (cm)

With the aid of a measuring scale, the height of the plant was measured from the soil's surface to the tips of its completely opened leaves, and an average was determined.

#### Numbers of leaves per plant

After transplanting and during the harvesting stage, the number of leaves per plant was counted at particular time intervals.

#### Shoot length (cm)

With the aid of a measuring scale, the shoot length was measured.

#### Leaf width per plant (cm)

With the aid of a measuring scale, the width of the leaf was measured.

### Fresh Weight/Dry Weight

Using a weighted balance, the fresh and dry weights of the entire plants were measured, and the average was then determined.

### Estimation of chlorophyll and carotenoid.

Leaf was collected from wheat grass, which was treated with microalgae and control. For the extraction procedure, leaves were washed with distilled water and allowed to dry at room temperature.

### Extraction

The extraction and analysis were performed as an alteration to the process described earlier [23]. The leaves were roughly chopped into little (20\*50 mm<sup>2</sup>) pieces, and 0.5 g of the leaves were pulverized in a mortar and pestle with 10 ml of 90% methanol or water. After two hours of sample freezing, the grounding was resumed. After centrifuging the homogenized material for 20 minutes at 10,000 rpm at 4 °C, 0.5 ml of the supernatant was combined with 4.5 ml of the appropriate solvents. The content of chlorophyll a, chlorophyll b, and carotenoids was then estimated using this solution in a spectrophotometer. Every measurement was carried out three times.

### Estimation

The concentrations of chlorophyll a, chlorophyll b, and total carotenoids were calculated using the equations reported by S. Nayek et al. [24], as follows:

$$\text{Chlorophyll a (Ch-a)} = 16.72(A665.2) - 9.16(A652.4)$$

$$\text{Chlorophyll b (Ch-b)} = 34.09(A652.4) - 15.28(A665.2)$$

$$\text{Total carotenoid content} = [1000(A470) - 1.63\text{Ch-a} - 104.96\text{Ch-b}] / 221$$





Khevna Pandya et al.,

## RESULTS AND DISCUSSION

Microalgae-treated plants triggered faster seed germination two days earlier than the control group. Only the microalgae culture treatment at least partially germinated the seeds by the third day. The majority of treatments had achieved a 90% germination rate by the fifth day. Given that most of the seeds exposed to these treatments did indeed sprout, it was determined that some of the seeds were not viable. Calculations of germination energy showed that germination and microalgae had a positive association. Germination occurs more quickly in the presence of microalgae than in the control plant. The wheatgrass seed inoculated with microalgae culture had a longer root development than the control group. The ability of plants to absorb water and nutrients increases with the number of lateral roots they have; therefore, seeds infected with microalgae culture could potentially accumulate more plant biomass and produce larger agricultural yields. The results show significant differences between the microalgae as a biofertilizer treatment that was applied for a 20-day seedling process compared to the control plant. Differences in several important growth parameters, such as the number of leaves, plant height, leaf weight, leaf width, leaf fresh weight, and dry weight, were observed. The results were obtained and presented in graphic form Fig. 2. Figure 2 shows the growth of a wheat grass plant treated with microalgae and a control plant after 25 days of experimental treatment. The growth parameters, such as the number of leaves, plant height, leaf weight, leaf width, leaf fresh weight, and dry weight, were found to be higher in the microalgae-treated plant as compared to the control plant.

The *M. reisseri*-treated plant yielded higher values than the control plant. The yield attributes, including plant height and total number of leaves, of the wheat grass plant noted superior values to those of the control plants. Overall observations of the developing plants revealed variations in plant mass under the biofertilizer treatments. According to the findings, the biofertilizer treatments given to seedling plants 25 days beforehand produced noticeably higher biomass with larger fresh weights for the shoots and roots (Fig. 2). In comparison to the control group, all biofertilized treatments resulted in a greater total fresh weight. According to Sharma and Upadhyay [25], using microalgal biofertilizers improves plant growth by increasing leaf area and improving photosynthesis rates. This leads to increased bulb length, diameter, and weight, which contribute to the production of vegetative parts and partitioning of the bulbs. Nasreen et al. [26] and El-Tantawy et al. [27] found that nitrogen-based fertilizers boosted dry total biomass in plant leaves. Pervez et al. [28] found that fertilizers had a significant impact on the maximum total biomass of plants. The majority of studies on the use of algae in agriculture have concentrated on cyanobacteria, or blue-green algae, in plants for a variety of reasons, the most significant of which is their capacity to fix atmospheric nitrogen into forms that plants can use [29, 30]. Alternatively, the algae have been used on macroalgae, or seaweeds, since they can be harvested from coastal regions and are simpler to handle than microalgae [31].

A renewed focus on using microalgae to produce biofuels has prompted greater research into possible products and/or by-product uses that could boost the viability of mass-scale culture and manufacturing. Due to their high retail values, bioactive compounds (nutraceutical, antioxidants, and food active ingredients) have been the focus of most research on the potential by-product applications of microalgae [32]. We think that the use of microalgal biomass or by-products as agrochemicals has a bigger unexplored market. Limited data supports the use of live microalgae culture, cell extracts, and dry biomass as possible agrochemicals. This study aimed to explore the potential agricultural applications of microalgae, specifically if *M. reisseri* live culture, cell extracts, and dry biomass may be used as biofertilizers for wheatgrass plants. Microalgal extracts have been linked to increased crop development through plant growth regulators (auxins, gibberellins, and cytokinins), as well as high amounts of macro- and micronutrients [33]. This study found that applying *M. reisseri* aqueous extracts, live culture, and dry biomass improved wheatgrass plant germination, growth, and yield. Our investigation found that using live *M. reisseri* culture and aqueous cell extracts enhanced seed germination percentages in all treatments compared to the control group. Using live *M. reisseri* culture resulted in faster germination and stronger seedlings. Chlorophyll and carotenoid content were determined in the microalgae-treated plant leaf and the control plant leaf. Chlorophyll and carotenoids were extracted with 90% methanol, and OD was measured using a spectrophotometer. Spectrophotometric data was substituted into the calculation. The results were obtained by comparing the





### Khevna Pandya et al.,

chlorophyll and carotenoid content graphically Fig. 3. When chlorophyll and carotenoid levels were estimated, plants treated with microalgae showed greater values than control plants. Presoaking lupinus seeds in *Aspergillus oryzae* culture filtrates greatly boosts the amount of chlorophyll a, b, and total chlorophylls in the leaves [34]. Higher levels of chlorophyll were seen in banana plants treated with the biofertilizer consortium, according to Senthil Kumar et al. [35] Ellora Malakar and Kalita's report, which noted that *Anabaena torulosa* had the highest levels of total and chlorophyll A among *Anabaena doliolum* and *Calothrix marchica*, corroborated the current findings. A higher buildup of chlorophyll content in organic fertilizers, albeit at a slower rate, may be the consequence of the consortium's synergistic impact, which improved the plant's uptake of N, P, and K. In this work, it was evident that treating wheatgrass seedlings with dry *M. reisseri* biomass (biofertilizer) increased all growth parameters and pigment content. There was a noticeable difference when the biomass was added a few weeks before the plants were transplanted, indicating that the biomass must first decompose before the plants can absorb it.

The seedlings that were given biofertilizer treatments a few days before being transplanted showed the highest rates of plant development and leaf count, which may indicate a higher crop production in theory. Aqueous cellular extracts, dry biomass, and live microalgae culture may boost plant development and increase the viability of algal production systems from an economic standpoint. New technologies will be required as climate change intensifies in order to improve and safeguard agricultural products globally. Microalgae present a viable solution to the problem of producing more food with limited resources. They can safeguard and enhance agricultural productivity while also benefiting farmers and algae producers in terms of the environment and economy. The wheatgrass plant treated with microalgae induced faster germination than the control plant. The more lateral roots a plant has, the more capacity it has to absorb water and nutrients. As a result, seeds treated with microalgae culture may accumulate more plant biomass and result in higher agricultural output. It was discovered that the microalgae-treated plants outgrew the control plant in every growth parameter, including plant weight, the number of leaves per plant, shoot length, fresh weight, and dried weight of leaves. Plants treated with microalgae generated higher levels of carotenoid and chlorophyll than control plants. The remarkable yields and growth rates of the *M. reisseri*-treated plant demonstrated the potential of microalgae as a biofertilizer for wheatgrass cultivation.

## REFERENCES

1. Carlsson SA, Van Beilen JB, Moller R, Clayton D, Bowles D. Micro- and Macro-algae: Utility for Industrial Applications: Outputs from the EPOBIO Project. CPL Press, Newbury; 2007.
2. Mulbry W, West head EK, Pizarro C, Sikora L. Recycling of manure nutrients: use of algal biomass from dairy manure treatment as a slow release fertilizer. Bioresour Technol 2005;96:451–458.
3. Mulbry W, Kondrad S, Pizarro C. Biofertilizers from algal treatment of dairy and swine manure effluents: characterization of algal biomass as a slow release fertilizer. J Veg Sci 2007; 12,107–125.
4. Ahmed MA, Ahmed AG, Mohamed MH, Tawfik MM. Integrated effect of organic and biofertilizers on wheat productivity in new reclaimed sandy soil. Res J Agric Biol Sci 2011;7:105–114.
5. Spolaore P, Joannis-Cassan C, Duran E, Isambert A. Commercial applications of microalgae. J. Biosci. Bioeng 2006; 101:87–96.
5. Kumari R., Kaur I, Bhatnagar AK. Effect of aqueous extract of *Sargassum john stonii* Set chell and gardner on growth, yield and quality of *Lycoper siconesulentum* Mill. J. Appl. Phycol 2011; 23:623–633.
6. Tripathi RD. Role of blue green algae biofertilizer in ameliorating the nitrogen demand and fly-ash stress to the growth and yield of rice (*Oryza sativa* L.). Plants Chemosphere 70 2008; 1919–1929.
7. Vessey JK. Plant growth promoting rhizobacteria as biofertilizers. Plant Soil 255 2003;571–586.
8. Burja AM, Banaigs B, Abou-Mansour E, Burgess JG, Wright, P.C. Marine cyanobacteria—a prolific source of natural products. Tetrahedron 57 2001;46:9347-9377.
9. Falch BS, König GM, Wright AD, Sticher O, Angerhofer CK, Pezzuto JM, Bachmann H. Biological activities of cyanobacteria: evaluation of extracts and pure compounds. Planta Med 1995; 61(4):321-8.





## Khevna Pandya et al.,

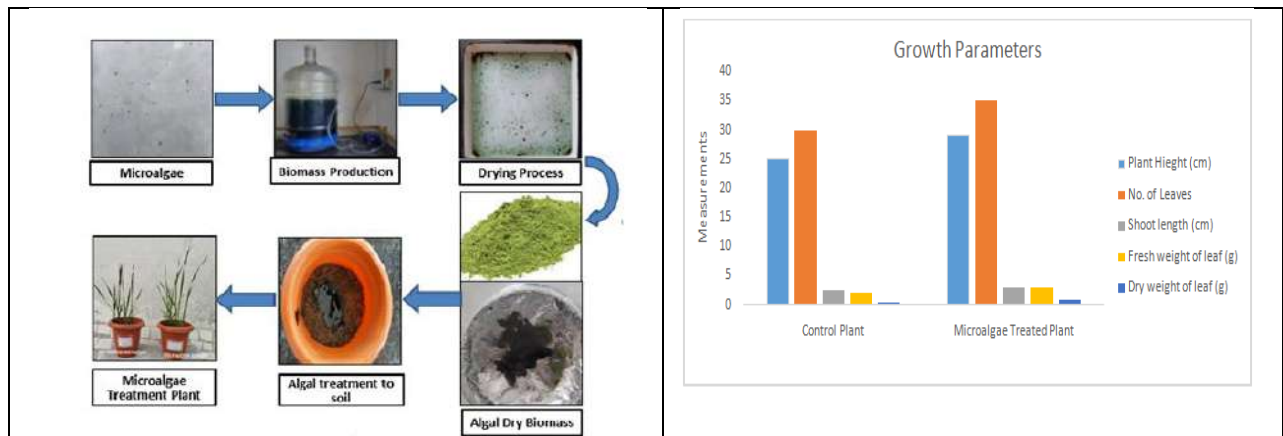
10. Moon SS, Chen JL, Moore RE, Patterson GML. Calophycin a fungicidal cyclic decapeptide from the terrestrial blue-green alga *Calothrix fusca*. J. Org. Chem 1992;57(4):1097-1103.
11. Kawalekar SJ. Role of biofertilizers and biopesticides for sustainable agriculture. J Biol Innov 2013; 2:73–78.
12. Abdel-Raouf N, Al-Homaidan AA, Ibraheem IBM. Agricultural importance of algae. Afr J Biotechnol 2012; 11:11648–11658
13. Shukla AC, Gupta AB. Agriculture: influence of algal growth promoting substances on growth, yield and protein contents of rice plants. Nature 1967; 213:744.
14. Kumar G, Sahoo D. Effect of seaweed liquid extract on growth and yield of *Triticum aestivum* var. Pusa Gold. J Appl Phycol 2011; 23:251–255.
15. Kumari R, Kaur I, Bhatnagar AK. Effect of aqueous extract of *Sargassum johnstonii* Setchell & Gardner on growth, yield and quality of *Lycopersicon esculentum* Mill. Journal of Applied Phycology 2011; 23(3):623-633.
16. Hernandez-Herrera RM, Santacruz-Ruvalcaba F, Ruiz-Lopez MA, Norrie J, Hernandez-Carmona G. Effect of liquid seaweed extracts on growth of tomato seedlings (*Solanum lycopersicum* L.). J Appl Phycol 2013; 26:619–628.
17. El-Khawaga, A.S.: Effect of anti-salinity agents on growth and fruiting of different date palm cultivars. Asian J Crop Sci 2013;5:65–80.
18. Dineshkumar R, Kumaravel R, Gopalsamy J, Sikder MNA, Sampathkumar P. Microalgae as bio-fertilizers for rice growth and seed yield productivity. Waste Biomass Valor 2017.
19. Dineshkumar R, Subramanian J, Gopalsamy J, Jayasingam P, Arumugam A, Kannadasan S, Sampathkumar P. The impact of using microalgae as biofertilizer in maize (*Zea mays* L.). Waste Biomass Valor 2017; 10(4).
20. Abd-Allah, SE, Abd El-Moniem-Eman A, Ahmed MA. The combined effect of some organic manures, mineral N fertilizers and algal extract on yield and fruit quality of *Williamsbanana* plants. Am. Euras. J. Agric. Environ. Sci. 2008; 4: 417–426.
21. Faheed AF, Abd-El Fattah Z. Effect of *Chlorella vulgaris* as biofertilizer on growth parameters and metabolic aspects of Lettuce plant. J. Agric. Soc. Sci 2008; 4(4); 165–169.
22. Nayek S, Choudhury H, Jaishree N, Roy S. Spectrophotometric analysis of chlorophylls and carotenoids from commonly grown Fern species by using Extracting solvents, 2014;4(9);63-69.
23. Sartory DP, Grobbelaar JU, Extraction of chlorophylla from freshwater phytoplankton for spectrophotometric analysis. Hydrobiologia. 1984;114:177–187.
24. Sharma A, Upadhyay BK. Marketing promotion policies in agriculture (special reference to National Fertilizer Limited). Mark. Promot. Policies Agric. India 1992;152:8–15.
25. Nasreen S, Haque MM, Hossian MA, Farid TM. Nutrient uptake and yield of onion as influenced by nitrogen and sulphur fertilization. Bangladesh J. Agric. Res 2007;32(3):413–420.
26. El-Tantawy E, El-Beik EM, El-Beik AK. Relationship between growth, yield and storability of onion (*Allium cepa* L.) with fertilization of nitrogen, sulphur and copper under calcareous soil conditions. Res J. Agric. Biol. Sci 2009;5:361–371.
27. Pervez MA, Ayub CM, Bashart A, Nave AV, Nasir M. Effect of nitrogen levels and spacing on growth and yield of radish (*Raphanus sativus* L.). Int. J. Agric. Biol. 2004;3(6):504–506.
28. Sharma NK, Tiwari SP, Tripathi K, Rai AK. Sustainability and cyanobacteria (blue-green algae): facts and challenges. J Appl Phycol 2010;23:1059–1081.
29. Jha MN, Prasad AN. Efficacy of new inexpensive cyanobacterial biofertilizer including its shelf-life. World J Microbiol Biotechnol 2006;22:73–79.
30. Zodape ST. Seaweeds as a biofertilizer. J Sci Ind Res 2001;60:378–382.
31. Plaza M, Santoyo S, Jaime L, Garcia-Blairsy Reina G, Herrero M, Senorans FJ, Ibanez E. Screening for bioactive compounds from algae. J Pharm Biomed Anal 2010;51:450–455.
32. Tarakhovskaya ER, Maslov YI, Shishova MF. Phytohormones in algae. Russ J Plant Physiol 2007;54:163–170.
33. Haroun AS, Hussein MH. The promotive effect of algal Biofertilizers on growth, protein pattern and some metabolic activities of *Lupinus terms* plant grown in siliceous soil. Asian J. Plant Sci 2003;2(13):944–951.





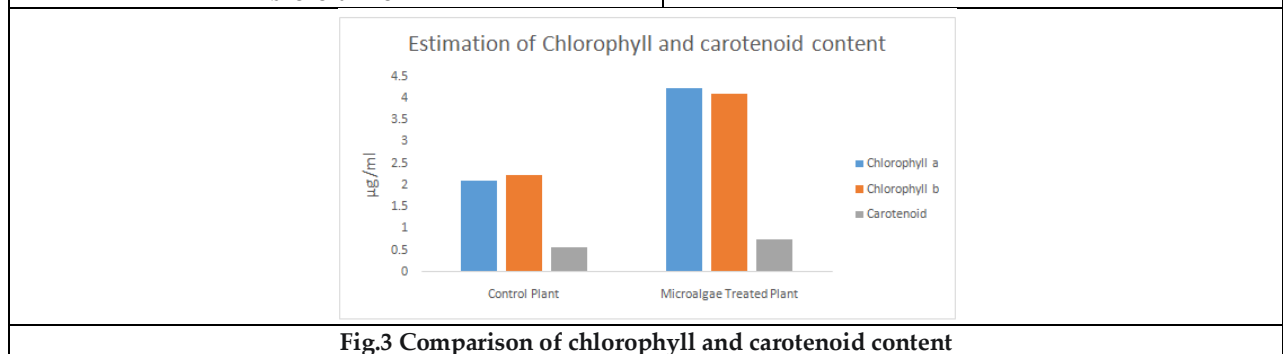
**Khevna Pandya et al.,**

34. Senthilkumar D, Satheesh P, Uthaya V, Anbuganapathi G. Influence of biofertilizer mixed flower waste vermicompost on the growth, yield and quality of groundnut (*Arachis hypogaea* L.). World Appl. Sci J. 2014;31(10):1715–1721.
35. Ellora Malakar, MC, Kalita A. Perspective towards development and commercialization of potential BGA biofertilizers of Assam, North East India and carrier materials for BGA mass production and inoculum development. Ann. Biol. Res 2012;3:814–828.



**Fig. 1 Experimental Set-up for Microalgae as a biofertilizer**

**Fig.2 Growth Parameter Measurement**



**Fig.3 Comparison of chlorophyll and carotenoid content**







## An Assessment of Determinants of Treatment Non-adherence in Mental Health Therapy: A Review of Literature

Jahangir Khan<sup>1</sup>, Suzana Hasan Ali Alqafeai<sup>1</sup> and Jwaad Akhtar Khan<sup>2\*</sup>

<sup>1</sup>Ph.D Scholar, Department of Healthcare and Pharmaceutical Management, School of Management and Business Studies, Jamia Hamdard (Deemed to be University) New Delhi, India.

<sup>2</sup>Assistant Professor, Department of Healthcare and Pharmaceutical Management, School of Management and Business Studies, Jamia Hamdard (Deemed to be University) New Delhi, India.

Received: 22 Jan 2024

Revised: 09 Feb 2024

Accepted: 29 Apr 2024

### \*Address for Correspondence

Jwaad Akhtar Khan  
Assistant Professor,  
Department of Healthcare and Pharmaceutical Management,  
School of Management and Business Studies,  
Jamia Hamdard (Deemed to be University)  
New Delhi, India.  
Email: jwaadakh@jamiyahamdard.ac.in



This is an Open Access Journal / article distributed under the terms of the **Creative Commons Attribution License** (CC BY-NC-ND 3.0) which permits unrestricted use, distribution, and reproduction in any medium, provided the original work is properly cited. All rights reserved.

### ABSTRACT

Early treatment discontinuation is prevalent among patients receiving mental health services. The determinants influencing treatment discontinuation may diverge from those influencing treatment initiation. Barriers and general determinants of non-compliance with therapy among individuals diagnosed with mental health disorders are discussed in this review article. To identify the variables that influence the patients' non-adherence to mental healthcare services. The authors provided an overview of the primary research conducted on patient non-adherence to mental health care, as documented in various databases and published articles. The current study includes an overview of the recent publications on factors contributing to non-adherence. The findings indicate that multiple factors lead to non-adherence in patients who suffer from mental health issues. Researchers classified these factors into two categories: non-clinical factors and clinical factors. However, factors such as medication efficacy, long treatment duration, treatment complexity, pill burden, and comorbidity need to be addressed to sustain health improvement and reduce the mental health treatment dropout ratio. The barriers to accessing behavioral health treatment in India include shame, stigma, and discrimination; absence of awareness; lack of psychiatry professionals; high cost of treatment; lack of mental health literacy; cultural beliefs and practices; geographical barriers; language barriers; and lack of integration with primary healthcare. Addressing these barriers will require a multifaceted approach, including increasing public





Jahangir Khan et al.,

awareness, improving mental health infrastructure, providing adequate funding for mental health services, and integrating psychiatric health with primary healthcare.

**Keywords:** Non-adherence, mental health, dropout factors, treatment barriers

## INTRODUCTION

The primary concern found among the individuals diagnosed with mental health disorders in a clinical outpatient setting is the failure to adhere to the prescribed course of treatment, sometimes resulting in the termination of medical care without seeking guidance from the treating doctor. Accessibility and patient adherence to the recommended treatment are the key factors that determine the success of any medical treatment, including mental health. Adherence to treatment is of the utmost importance across the field of psychiatric treatment, as consistent adherence to therapy can have a substantial positive influence on treatment results. According to studies, 20%-50% of patients are not in compliance with their treatment regimen, and this percentage increases to 70%-80% for people with mental health illnesses [1]. Psychiatric disorders expect long periods of post-treatment monitoring to prevent relapses and improve the individual's psychological well-being [2]. Despite over 50 years of research on this topic, immature cessation rates continue to be high, particularly among adult population. Research studies regularly report higher percentages of early mental health care terminations. According to research, 30-50% of patients discontinue their treatment after their first therapy session [3]. Depression and anxiety, among the most prevalent mental health diseases, are significant contributors to the overall burden of years lived with disability worldwide.

In poor and middle-income nations, the available data suggests that a significant majority of individuals suffering from depression (79-93%) and anxiety (85-95%) are unable to access the necessary medical care [4]. Globally, psychiatric disorders provide a significant public health concern. Mental health disorders have a global impact, affecting approximately 450 million individuals. It contributes to 14% of the total global burden of diseases. Additionally, psychiatric diseases cost around US\$2.5 trillion in 2010 and projected to go up to US\$6.0 trillion by 2030 [5]. Mental health diseases account for 11.8% of India's overall illness burden [6]. Only 10% of mental illness patients receive evidence-based therapy. [7]. In accordance to the India's National Mental Health Survey, 2016, the lifetime prevalence is 13.67%, with an intervention gap of 84.5% for any mental condition [8]. Indian government took steps towards addressing the mental health needs of its residents with the help of National Mental Health Programme and later with District Mental Health Programme by considering the main objectives of ensuring the availability and accessibility of a minimum level of mental health treatment for all, by fostering mental health knowledge and expertise in general medical services, and promoting public involvement in the development of behavioural health services [9][8].

### Non-adherence

As per the World Health Organization's definition of non-adherence to medication, this occurs when a person does not take their medication in accordance with the recommendations of their doctor or other healthcare provider [10]. Regardless of the number of visits, researchers have defined non-adherence as the act of terminating therapy without the approval of the physician [11]. As per Hatchett et al.'s study, non-adherence refers to the failure to attend the most recent scheduled appointment [12]. Technically, a dropout is ending contact with practitioners without a treatment solution or mutually agreed-upon termination. [13]. Longo et al. defined non-adherence as not following up after an initial therapy session. [14].

### Factors affecting non-adherence

A prior study with individuals diagnosed with mental disorders highlighted that factors associated with patients that influenced adherence include male gender, young age, unemployment, poor socio-economic class, substance abuse, monetary challenges, and prior instances of not adhering to treatment [15][16][17][18][19]. Non-compliance is



**Jahangir Khan et al.,**

also related to disease-related factors such as the seriousness of the disease, lack of awareness, cognitive impairment, and unpleasant experiences [15][16][18]. Treatment ineffectiveness, adverse drug reactions, and the complicated approach to treatment were among the treatment-related factors that led to non-adherence [15][16][18]. A few psychological and social factors have been found to affect treatment adherence. These include the shame and guilt that come with having a mental illness, patients' different beliefs about what caused their illness, such as stressful life events or supernatural activity, support from family members, and ease of access to medical facilities[20][21][18].

**Consequences of Non-adherence**

Untreated or irregularly treated mental health problems can lead to poor quality of life, mental or physical impairment, poverty, unemployment, low income, stress on caretakers, marriage separation, homelessness, domestic violence, substance abuse, etc. [22]. Moreover, studies have shown that failure to comply with medical recommendations is linked to higher incidences of unintended hospitalizations, slow healing, and extended stays at the health facilities[23], greater possibility of committing suicide, a poor prognosis.[24], and poor satisfaction with life [25]. Approximately 31.7% of those diagnosed with serious psychological disorders develop long-term dysfunction and dependency on others [26]. Unattended patients with mental health problems often go untreated, while those with families who are seeking help often turn to alternative practitioners, such as those from Indian indigenous medicine, astrologers, and religious or faith-based practitioners[27]. The factors responsible for treatment dropout could be different from the factors responsible for not starting treatment. Younger age, belonging to a minority group, absence of medical insurance, unemployment, low income, lack of education, comorbid mood disorders, and drug dependency have been found to increase the risk of treatment dropouts [28]. This review article addresses the general determinants of non-compliance with therapy among individuals diagnosed with mental health disorders.

**LITERATURE REVIEW**

A number of studies indicate that a significant proportion, ranging from 30.0% to 60%, of individuals diagnosed with mental health disorders terminate their medical treatment without the consent of their treating physician [29][30]. According to a study by Australia's Headspace, a sizable percentage of 30–75% of young adults who have access to psychiatric services tend to end therapy early[31]. Demyttenaere et al. (2004) found that between 75% to 85% of individuals with serious mental illness disorders in poor and middle-income nations have no access to the required medical treatment, compared to 35% to 50% in higher-income countries [32]. Research indicates that over 50% of people with schizophrenia may not follow the recommended treatment plan[33][34]. According to research conducted in Ethiopia, the overall incidence of medication non-compliance was shown to be 51.20%. The respondents cited several explanations for their non-adherence, including negligence (20.2%), being out of medication (5.4%), observing adverse effects (8.5%), and experiencing improvement or believing they are healed (11.7%) [35]. Prior research conducted in India has shown diverse estimates of treatment non-adherence rates across different mental health conditions. Among the 528 patients, 29.7% utilized behavioral health services consistently for twelve months or longer. Most of the patients(36.2%) discontinued therapy after their initial visit, while 34.1% ended subsequent visits within the first week to the twelfth month [36]. A study conducted in Rohtak, Haryana, found that 38.2% of patients discontinued therapy after their very first consultation. Out of the remaining patients, 61.8% stopped their medication within six months [37]. In their 2013 research study, Banerjee and Varma interviewed 239 people with unipolar depression. Out of these, 66.9% (160) were found to be non-adherent to therapy, while 33.1% (79) were adherent [38]. In accordance with Grover et al., 25% of elderly individuals terminate their treatment soon after their first encounter [39]. A total of 50 patients displaying evidence of schizophrenia had been interviewed. Out of these patients, 8 (16%) were classified as high adherers, 16 (32%) as moderate adherers, and 26 (52%) as poor adherers [18]. An Indian study identified certain elements that contribute to treatment non-adherence. The main factors contributing to the problem are: a lack of knowledge about the illness (93.75%); insufficient support from family members (56.25%); religious beliefs attributing the illness (56.25%); financial limitations (37.5%); dynamics within the family (43.75%); the family's level of acceptance (43.75%); a lack of understanding of the illness (31.25%);





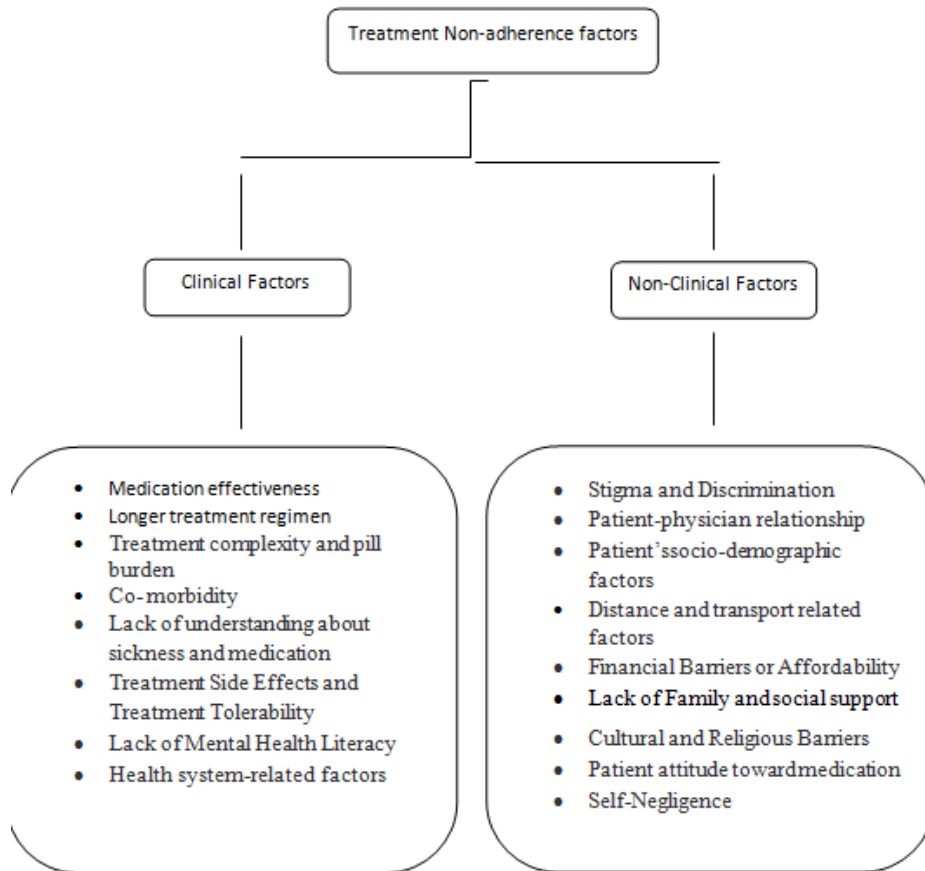
**Jahangir Khan et al.,**

the family's ability to cope (25.0%); community beliefs about mental diseases (25%); and other factors [40]. Approximately 61.54% of the patients who did not comply with their therapy cited "adverse effects of medications" as the cause of their non-adherence. Additionally, 53.85% of the patients said that they saw the treatment as ineffective, leading them to discontinue their prescribed treatment [18].

**DISCUSSION**

**Reviewing the factors affecting the patient's non-adherence to mental health services.**

The factors responsible for treatment dropout could be different from the factors responsible for not starting treatment. The researcher attempts to identify the factors responsible for treatment drop out (non-adherence). It has been found in numerous studies that patient non-adherence depends on various elements. In order to review these determinants, the researcher has categorized the factors into two clusters, as shown below in the framework:



**Clinical factors**

**Medication effectiveness**

Lower medication efficacy and Patients' and caretakers' perceived effectiveness, such as perceived symptom relief or medications having no effect on the illness, are side-effect-related variables that led to non-compliance [41][42][43].

**Longer treatment regimen**

Prolonged duration of treatment (6–12 months and beyond) was identified as a contributing factor for treatment non-adherence [44][5].





Jahangir Khan *et al.*,

### **Treatment complexity and Pill burden**

Complicated treatment plans, multiple dosages frequencies and various drug combinations were major causes of treatment non-adherence. Pill burden, or taking extra pills, also affected psychotropic drug adherence [45][46]. Furthermore, the method of administering medication had a notable impact on adherence to therapy. The individuals receiving injectable treatment had higher adherence rates compared to those who were orally administered medications [41].

### **Co-morbidity**

Research has indicated that people who have other medical conditions in addition to their existing psychiatric problems are more inclined to not follow to their prescribed medicines[44].

### **Lack of understanding about sickness and medication**

Lack of insight regarding their disease and treatment was among the most common factors responsible for non-adherence to psychiatric drug therapy [28][4]. Lack of treatment compliance in mental health disorders was caused by misunderstandings related to the effects of treatment, a lack of understanding of their sickness or mental problems, and, in some cases, satisfaction with subjective relief of symptoms [5].

### **Treatment Side Effects and Treatment Tolerability**

Several research studies have identified a link between non-adherence to psychiatric medication and the rate of drug-related side effects [47]. Added to that, patients and their attendants' reported medication adverse effects were associated with mental health treatment non-adherence [48]. The most commonly reported adverse effects that contribute to discontinuing mental health treatment were feeling dizziness, drowsiness, tiredness, restlessness, lethargy, and sleepiness [49].

### **Lack of Mental Health Literacy**

The absence of information regarding psychiatric health conditions, treatment options, and the potential benefits of therapy may contribute to non-compliance [50].

### **Health system-related factors**

Adherence to therapy could be greatly influenced by various factors related to healthcare practitioners, such as their level of experience, awareness of culture, and ability to communicate. In addition, systematic barriers such as lengthy waiting times, administrative issues, and disorganized treatment services may have an impact on therapy continuity [46][51]. The shortage of healthcare professionals is also having an impact on compliance with treatment [52].

### **Non Clinical Factors**

#### **Stigma and Discrimination**

One of the primary obstacles that individuals have while seeking and complying with mental health therapy is the prevalent social stigma associated with mental diseases. The presence of social stigma might result in persons disguising their difficulties, postponing the pursuit of assistance, or prematurely terminating treatment as a consequence of fear regarding society judgment or isolation [7][53][54]. "Stigma and discrimination of mental health disease and treatment" in mental disorders like schizophrenia are broadly accepted. The fear of discrimination due to the stigma or shame of taking treatment can cause individuals to stop their treatment [18].

#### **Patient-physician relationship**

A strong relationship between the patient and the doctor or therapist is required for better treatment compliance. The variables responsible for non-compliance to mental health treatment include unpleasant and prejudiced conduct of physician, rigid scheduling rules, poor interaction between patients and physicians and mistrust[55].

#### **Patient's socio-demographic factors**

Medication non-adherence has been associated with some socio-demographic factors among mental patients. Joblessness was one of the variables responsible for treatment non-adherence [56]. The education level of individuals





Jahangir Khan *et al.*,

was found to be a key element in the occurrence of treatment non-adherence. Mental health patients with a lower level of education are more prone to non-adherence to their drug therapy in comparison to individuals with a higher level of education [57][51]. Patients' non-compliance to their mental health treatments was also associated to certain non-modifiable demographic variables such as gender and age [55].

#### **Distance and transport related factors**

Behavioral health services are generally very limited in remote locations, requiring patients to travel longer distances. Shortage of public transportation and health resources may make mental health adherence more difficult [48][42]. The significant travel to access healthcare services and to get medicines can lead to non-compliance with treatment in mental health services. [40].

#### **Financial Barriers or Affordability**

The high cost of therapy and the limited availability of behavioral health services continue to be primary barrier, particularly for underprivileged populations. Financial obstacles frequently prevent patients from accessing the appropriate care they need [58][4]. Approximately half of the patients reported "financial difficulties" as the primary cause of their non-compliance with therapy [18].

#### **Lack of Family and social support**

Research studies indicate that absence of family or social support is linked with non-compliance to mental health treatment [59][60]. Factors such as lower harmony in families or inadequate support from family, discrimination from community individuals, disturbance in family relations and spiritual beliefs, impaired community functioning, being homeless, the absence of caregivers, and a lack of social assistance were identified to be responsible for non-adherence to psychotropic treatment. [61][40].

#### **Cultural and Religious Barriers**

Patients' different ideologies regarding treatment may result in treatment discontinuation (e.g., witchcraft, supernatural powers, etc.) [18]. Cultural customs, religious convictions, and spiritual faith all have a significant impact on how people view mental illness. Cultural differences may make it difficult to get assistance with mental health issues. Individuals may also be discouraged from seeking assistance or following treatment regimens due to cultural and religious barriers [62][28].

#### **Patient attitude toward medication**

Patients' beliefs about medicines became a significant factor influencing treatment adherence. Patients' negative perception regarding the medicine is an important variable responsible for psychiatric treatment non-adherence [35].

#### **Patient's perception of treatment**

Individuals who believed that therapy have no impact on their disease became more prone to non-compliance with their prescription. Considering treatment useless is another important factor in non-compliance [54].

#### **Self-Negligence**

Both caregivers and patients reported that being engaged with their routine tasks, irresponsible with timings, failing to recall medicine timing, and inconsistent follow-up has been associated with treatment non-adherence [51][63]. In the worst-case scenario, individuals' complete denial of the drug was a major reason for cessation and non-adherence to their prescription [55].

#### **Belief about alternative therapies**

Various beliefs regarding the efficacy and utility of medical treatments or other forms of treatment may have an impact on how well a patient adheres to therapy. Patients who had negative perspectives about psychiatric medications were more inclined to consider other options for treatment, such as conventional or spiritual approaches to treatment [45][28].





Jahangir Khan et al.,

## CONCLUSION

This review article addresses the general factors and determinants of treatment non-adherence among individuals diagnosed with mental health disorders. The researcher has addressed the research objective to determine the factors that impact patients' non-adherence to mental health care services; hence, this review of literature has provided a list of elements responsible for treatment discontinuation from behavioral health facilities. These factors were the primary causes of the majority of issues experienced by mental health patients, irrespective of the frequency of occurrence in most cases. Psychological health treatment is crucial for promoting the well-being of people; however, in India, mental health services are often inaccessible due to various barriers, and poor adherence to recommended therapy into an outpatient medical setting seems to be a prevalent problem amongst individuals diagnosed with mental illness, which is characterized by treatment termination without informing their treating doctor. The barriers to accessing behavioural health treatment in India include shame, stigma and discrimination, absence of awareness, lack of psychiatry professionals, high cost of treatment, lack of mental health literacy, cultural beliefs and practices, geographical barriers, language barriers, and lack of integration with primary healthcare. Addressing these barriers will require a multifaceted approach, including increasing public awareness, improving mental health infrastructure, providing adequate funding for mental health services, and integrating psychiatry health with primary healthcare. The problem of treatment non-compliance in behavioral health services can be addressed by adopting the home visit approach, using tracking and tracing strategies, and implementing appropriate technology. The implementation of a patient-centered treatment engagement service is necessary in order to effectively address issues related to dropout rates and reasons for discontinuation within the treatment process. Overall, improving access to mental health treatment in India is crucial for promoting the well-being of individuals and addressing the national burden of mental disorders. Healthcare professionals and authorities should prioritize these issues and allocate greater attention to them.

## REFERENCES

1. R. Breen and J. T. Thornhill, "Noncompliance with medication for psychiatric disorders: Reasons and remedies," *CNS Drugs*, vol. 9, no. 6, pp. 457–471, 1998, doi: 10.2165/00023210-199809060-00004.
2. S. B. Sriramulu, A. R. Elangovan, M. Isaac, and J. R. Kalyanasundaram, "Treatment non-adherence pattern among persons with neuropsychiatric disorders: A study from a rural community mental health centre in India," *Int. J. Soc. Psychiatry*, vol. 68, no. 4, pp. 844–851, Jun. 2022, doi: 10.1177/00207640211008462.
3. F. Baekeland and L. Lundwall, "Dropping out of treatment: A critical review," *Psychol. Bull.*, vol. 82, no. 5, pp. 738–783, 1975, doi: 10.1037/h0077132.
4. G. M. Esponda, S. Hartman, O. Qureshi, E. Sadler, A. Cohen, and R. Kakuma, "Barriers and facilitators of mental health programmes in primary care in low-income and middle-income countries," *The Lancet Psychiatry*, vol. 7, no. 1, pp. 78–92, 2020, doi: 10.1016/S2215-0366(19)30125-7.
5. A. Semahegn, K. Torpey, A. Manu, N. Assefa, G. Tesfaye, and A. Ankomah, "Psychotropic medication non-adherence and its associated factors among patients with major psychiatric disorders: A systematic review and meta-analysis," *Syst. Rev.*, vol. 9, no. 1, pp. 1–18, 2020, doi: 10.1186/s13643-020-1274-3.
6. V. Patel et al., "Chronic diseases and injuries in India," *Lancet*, vol. 377, no. 9763, pp. 413–428, 2011, doi: 10.1016/S0140-6736(10)61188-9.
7. R. Shidhaye and M. Kermode, "Stigma and discrimination as a barrier to mental health service utilization in India," *Int. Health*, vol. 5, no. 1, pp. 6–8, Mar. 2013, doi: 10.1093/inthealth/ihs011.
8. B. S. Pradeep et al., "National mental health survey of India, 2016 - rationale, design and methods," *PLoS One*, vol. 13, no. 10, Oct. 2018, doi: 10.1371/JOURNAL.PONE.0205096.
9. R. Sagar et al., "Twelve-month prevalence and treatment gap for common mental disorders: Findings from a large-scale epidemiological survey in India," *Indian J. Psychiatry*, vol. 59, no. 1, pp. 46–55, 2017, doi: 10.4103/psychiatry.IndianJPsychiatry\_333\_16.





**Jahangir Khan et al.,**

10. W. H. Organization, *Adherence to long-term therapies: evidence for action*. 2003. Accessed: Nov. 14, 2023. [Online]. Available: <https://apps.who.int/iris/bitstream/handle/10665/42682/9?sequence=1>
11. G. Pekarik, "Relationship of clients' reasons for dropping out of treatment to outcome and satisfaction," *J. Clin. Psychol.*, vol. 48, no. 1, pp. 91–98, 1992, doi: 10.1002/1097-4679(199201)48:1<91::AID-JCLP2270480113>3.0.CO;2-W.
12. G. T. Hatchett, K. Han, and P. G. Cooker, "Predicting premature termination from counseling using the Butcher Treatment Planning Inventory," *Assessment*, vol. 9, no. 2, pp. 156–163, 2002, doi: 10.1177/10791102009002006.
13. A. Rossi, F. Amaddeo, G. Bisoffi, M. Ruggeri, G. Thornicroft, and M. Tansella, "Dropping out of care: Inappropriate terminations of contact with community-based psychiatric services," *Br. J. Psychiatry*, vol. 181, no. OCT., pp. 331–338, 2002, doi: 10.1192/bjp.181.4.331.
14. D. A. Longo, R. W. Lent, and S. D. Brown, "Social Cognitive Variables in the Prediction of Client Motivation and Attrition," *J. Couns. Psychol.*, vol. 39, no. 4, pp. 447–452, 1992, doi: 10.1037/0022-0167.39.4.447.
15. I. S. Chandra, K. L. Kumar, M. P. Reddy, and C. M. P. K. Reddy, "Attitudes toward medication and reasons for non-compliance in patients with schizophrenia," *Indian J. Psychol. Med.*, vol. 36, no. 3, pp. 294–298, 2014, doi: 10.4103/0253-7176.135383.
16. D. Velligan, P. Weiden, M. Sajatovic, and J. Scott, "The expert consensus guideline series: adherence problems in patients with serious and persistent mental illness," 2009, Accessed: Jun. 12, 2023. [Online]. Available: <https://www.psychiatrist.com/read-pdf/455/v70s0401.pdf>
17. T. N. Srinivasan and R. Thara, "Beliefs about causation of schizophrenia: Do Indian families believe in supernatural causes?," *Soc. Psychiatry Psychiatr. Epidemiol.*, vol. 36, no. 3, pp. 134–140, 2001, doi: 10.1007/s001270050302.
18. B. Chaudhari, D. Saldanha, A. Kadiani, and R. Shahani, "Evaluation of treatment adherence in outpatients with schizophrenia," *Ind. Psychiatry J.*, vol. 26, no. 2, p. 215, 2017, doi: 10.4103/IPJ.IPJ\_24\_17:
19. S. Sarkar, K. Mathan, S. Sakey, S. Shaik, K. Subramanian, and S. Kattimani, "Cost-of-treatment of clinically stable severe mental illnesses in India," *Indian J. Soc. Psychiatry*, vol. 33, no. 3, p. 262, 2017, doi: 10.4103/0971-9962.214600.
20. S. Sharif, G. Ogunbanjo, and N. Malete, "Reasons for non-compliance to treatment among patients with psychiatric illness: A qualitative study," *South African Fam. Pract.*, vol. 45, no. 4, pp. 10–13, Apr. 2003, Accessed: Jun. 12, 2023. [Online]. Available: <https://www.ajol.info/index.php/safp/article/view/13055>
21. T. J. Hudson et al., "A pilot study of barriers to medication adherence in schizophrenia," *J. Clin. Psychiatry*, vol. 65, no. 2, pp. 211–216, 2004, doi: 10.4088/JCP.v65n0211.
22. S. Grover, S. Mallnaik, S. Chakrabarti, and A. Mehra, "Factors associated with dropout from treatment: An exploratory study," *Indian J. Psychiatry*, vol. 63, no. 1, pp. 41–51, 2021, doi: 10.4103/psychiatry.IndianJPsychiatry\_87\_19.
23. J. P. McEvoy, A. C. Howe, and G. E. Hogarty, "Differences in the nature of relapse and subsequent inpatient course between medication-compliant and noncompliant schizophrenic patients," *J. Nerv. Ment. Dis.*, vol. 172, no. 7, pp. 412–416, 1984, doi: 10.1097/00005053-198407000-00007.
24. D. L. Roberts and D. I. Velligan, "Medication adherence in schizophrenia," *Drug Discovery Today: Therapeutic Strategies*, vol. 8, no. 1–2, pp. 11–15, 2011. doi: 10.1016/j.ddstr.2011.10.001.
25. H. Ascher-Svanum, D. E. Faries, B. Zhu, F. R. Ernst, M. S. Swartz, and J. W. Swanson, "Medication adherence and long-term functional outcomes in the treatment of Schizophrenia in usual care," *J. Clin. Psychiatry*, vol. 67, no. 3, pp. 453–460, 2006, doi: 10.4088/JCP.v67n0317.
26. C. D. Mathers and D. Loncar, "Projections of global mortality and burden of disease from 2002 to 2030," *PLoS Med.*, vol. 3, no. 11, pp. 2011–2030, Nov. 2006, doi: 10.1371/JOURNAL.PMED.0030442.
27. S. K. Khandelwal, H. P. Jhingan, S. Ramesh, R. K. Gupta, and V. K. Srivastava, "India mental health country profile," *International Review of Psychiatry*, vol. 16, no. 1–2, pp. 126–141, Feb. 2004. doi: 10.1080/09540260310001635177.
28. B. Bruwer, "Barriers to Mental Health Care and Predictors of Treatment Dropout in the South African Stress and Health Study," *Psychiatr. Serv.*, vol. 62, no. 7, p. 774, Jul. 2011, doi: 10.1176/appi.ps.62.7.774.
29. R. Lingam and J. Scott, "Treatment non-adherence in affective disorders," *Acta Psychiatr. Scand.*, vol. 105, no. 3,







**Jahangir Khan et al.,**

- pp. 164–172, 2002, doi: 10.1034/J.1600-0447.2002.1R084.X.
30. K. Demyttenaere and P. Haddad, "Compliance with antidepressant therapy and antidepressant discontinuation symptoms," *Acta Psychiatr. Scand. Suppl.*, vol. 101, no. 403, pp. 50–56, 2000, doi: 10.1111/J.1600-0447.2000.TB10948.X.
  31. Z. E. Seidler et al., "Patterns of Youth Mental Health Service Use and Discontinuation: Population Data from Australia's Headspace Model of Care," *Psychiatr. Serv.*, vol. 71, no. 11, pp. 1104–1113, 2020, doi: 10.1176/APPI.PS.201900491.
  32. O. Contribution, "Prevalence, Severity, and Unmet Need for Treatment of Mental Disorders in the World Health Organization World Mental Health Surveys," *lirias.kuleuven.be*, vol. 291, no. 21, pp. 2581–2590, 2017, Accessed: Jun. 13, 2023. [Online]. Available: <https://lirias.kuleuven.be/191655?limo=0>
  33. J. P. Lacro, L. B. Dunn, C. R. Dolder, S. G. Leckband, and D. V. Jeste, "Prevalence of and risk factors for medication nonadherence in patients with schizophrenia: A comprehensive review of recent literature," *Journal of Clinical Psychiatry*, vol. 63, no. 10, pp. 892–909, 2002. doi: 10.4088/JCP.v63n1007.
  34. J. M. Kane, "Compliance issues in outpatient treatment," *J. Clin. Psychopharmacol.*, vol. 5, no. 3, pp. 22S–27S, 1985, doi: 10.1097/00004714-198506001-00005.
  35. G. Hibde, Y. Dessalegne, N. Debero, L. Bekan, and M. Sintayehu, "Prevalence of drug non adherence and associated factors among patients with bipolar disorder at outpatient unit of Amanuel Hospital, Addis Ababa, Ethiopia, 2013," *African J. Psychiatry (South Africa)*, vol. 18, no. SpecialIssue, pp. 1–7, 2015, doi: 10.4172/2378-5756.1000003.
  36. S. B. Sriramulu, A. R. Elangovan, M. Isaac, and J. R. Kalyanasundaram, "Treatment non-adherence pattern among persons with neuropsychiatric disorders: A study from a rural community mental health centre in India," *Int. J. Soc. Psychiatry*, vol. 68, no. 4, pp. 844–851, 2022, doi: 10.1177/00207640211008462.
  37. N. Jain, S. Arya, and R. Gupta, "Predictors of dropout from outpatient mental health services; A study from Rohtak, India," *J. Neurosci. Rural Pract.*, vol. 8, no. 4, pp. 535–539, Oct. 2017, doi: 10.4103/jnrp.jnrp\_119\_17.
  38. S. Banerjee and R. P. Varma, "Factors Affecting Non-Adherence among Patients Diagnosed with Unipolar Depression in a Psychiatric Department of a Tertiary Hospital in Kolkata, India," *Depress. Res. Treat.*, vol. 2013, p. 12, 2013, doi: 10.1155/2013/809542.
  39. S. Grover, D. Dua, S. Chakrabarti, and A. Avasthi, "Dropout rates and factors associated with dropout from treatment among elderly patients attending the outpatient services of a tertiary care hospital," *Indian J. Psychiatry*, vol. 60, no. 1, pp. 49–55, 2018, doi: 10.4103/psychiatry.IndianJPsychiatry\_410\_17.
  40. S. K. Reddy et al., "Factors influencing access to psychiatric treatment in persons with schizophrenia: A qualitative study in a rural community," *Indian J. Psychiatry*, vol. 56, no. 1, pp. 54–60, Jan. 2014, doi: 10.4103/0019-5545.124714.
  41. J. M. Olivares et al., "Long-term outcomes in patients with schizophrenia treated with risperidone long-acting injection or oral antipsychotics in Spain: Results from the electronic Schizophrenia Treatment Adherence Registry (e-STAR)," *Eur. Psychiatry*, vol. 24, no. 5, pp. 287–296, 2009, doi: 10.1016/j.eurpsy.2008.12.002.
  42. S. Teferri, C. Hanlon, T. Beyero, L. Jacobsson, and T. Shibre, "Perspectives on reasons for non-adherence to medication in persons with schizophrenia in Ethiopia: A qualitative study of patients, caregivers and health workers," *BMC Psychiatry*, vol. 13, p. 1, Jun. 2013, doi: 10.1186/1471-244X-13-168.
  43. M. Kikkert, A. Schene, ... M. K.-S., and U. 2006, "Medication adherence in schizophrenia: exploring patients', carers' and professionals' views," *academic.oup.com*, vol. 32, no. 4, pp. 786–794, 2006, Accessed: Jan. 01, 2024. [Online]. Available: <https://academic.oup.com/schizophreniabulletin/article-abstract/32/4/786/1937892>
  44. M. Sajatovic, M. Valenstein, F. C. Blow, D. Ganoczy, and R. V. Ignacio, "Treatment adherence with antipsychotic medications in bipolar disorder," *Bipolar Disord.*, vol. 8, no. 3, pp. 232–241, Jun. 2006, doi: 10.1111/J.1399-5618.2006.00314.X.
  45. Ibrahim, M. M. Yerima, I. B. Rabbebe, H. A. Garkuwa, and Yahya, "Medication-related factors of non adherence among patients with schizophrenia and bipolar disorder: Outcome of a cross-sectional survey in Maiduguri, North," vol. 7, no. 5, pp. 31–39, 2015, doi: 10.5897/JNBH2015.0128.
  46. E. A. Muche, A. E. Gurmu, E. Abdela, B. Allele, E. Cheru, and B. Amogne, "Rate of Nonadherence to Antipsychotic Medications and Factors Leading to Nonadherence among Psychiatric Patients in Gondar





**Jahangir Khan et al.,**

- University Hospital," *downloads.hindawi.com*, 2014, doi: 10.1155/2014/475812.
47. F. Taj *et al.*, "Factors associated with non-adherence among psychiatric patients at a tertiary care hospital, Karachi, Pakistan: A questionnaire based cross-sectional study," *J. Pak. Med. Assoc.*, vol. 58, no. 8, pp. 432–436, 2008, Accessed: Jan. 08, 2024. [Online]. Available: [https://ecommons.aku.edu/cgi/viewcontent.cgi?referer=&httpsredir=1&article=1012&context=pakistan\\_fhs\\_mc\\_psychiatry](https://ecommons.aku.edu/cgi/viewcontent.cgi?referer=&httpsredir=1&article=1012&context=pakistan_fhs_mc_psychiatry)
  48. S. Chopra, P. Bansal, and P. Bansal, "Journal of Advanced Medical and Dental Sciences Research |Vol. 8|Issue 1|," *J Adv Med Dent Scie Res*, vol. 8, no. 1, pp. 184–186, 2020, doi: 10.21276/jamdsr.
  49. M. DiBonaventura, S. Gabriel, L. Dupclay, S. Gupta, and E. Kim, "A patient perspective of the impact of medication side effects on adherence: Results of a cross-sectional nationwide survey of patients with schizophrenia," *BMC Psychiatry*, vol. 12, Mar. 2012, doi: 10.1186/1471-244X-12-20.
  50. S. Mohamed *et al.*, "Cross-sectional and Longitudinal Relationships Between Insight and Attitudes Toward Medication and Clinical Outcomes in Chronic Schizophrenia," *researchgate.net*, 2008, doi: 10.1093/schbul/sbn067.
  51. T. A. Burra, E. Chen, R. S. McIntyre, S. L. Grace, E. R. Blackmore, and D. E. Stewart, "Predictors of self-reported antidepressant adherence," *Behav. Med.*, vol. 32, no. 4, pp. 127–134, Dec. 2007, doi: 10.3200/BMED.32.4.127-134.
  52. A. Rashid Khan RCSI, U. Malaysia Campus, A. Rashid, and M. Rahmah, "Treatment Related Risk Factors Associated with the Default of Depression Treatment Among the Elderly—A Case Control Study," *researchgate.net*, vol. 3, pp. 11–16, 2010, Accessed: Jan. 09, 2024. [Online]. Available: [https://www.researchgate.net/profile/Abdul-Khan-92/publication/228988401\\_Treatment\\_Related\\_Risk\\_Factors\\_Associated\\_with\\_the\\_Default\\_of\\_Depression\\_Treatment\\_Among\\_the\\_Elderly-A\\_Case\\_Control\\_Study/links/0deec52f827a8a5143000000/Treatment-Related-Risk-Factors-Associated-with-the-Default-of-Depression-Treatment-Among-the-Elderly-A-Case-Control-Study.pdf](https://www.researchgate.net/profile/Abdul-Khan-92/publication/228988401_Treatment_Related_Risk_Factors_Associated_with_the_Default_of_Depression_Treatment_Among_the_Elderly-A_Case_Control_Study/links/0deec52f827a8a5143000000/Treatment-Related-Risk-Factors-Associated-with-the-Default-of-Depression-Treatment-Among-the-Elderly-A-Case-Control-Study.pdf)
  53. R. Raguram, T. M. Raghu, P. Vounatsou, and M. G. Weiss, "Schizophrenia and the cultural epidemiology of stigma in Bangalore, India," *J. Nerv. Ment. Dis.*, vol. 192, no. 11, pp. 734–744, 2004, doi: 10.1097/01.nmd.0000144692.24993.1b.
  54. J. A. Sirey, M. L. Bruce, G. S. Alexopoulos, D. A. Perlick, S. J. Friedman, and B. S. Meyers, "Perceived stigma and patient-rated severity of illness as predictors of antidepressant drug adherence," *Psychiatr. Serv.*, vol. 52, no. 12, pp. 1615–1620, 2001, doi: 10.1176/appi.ps.52.12.1615.
  55. S. Moritz, J. Favrod, C. Andreou, ... A. M.-S., and undefined 2013, "Beyond the usual suspects: positive attitudes towards positive symptoms is associated with medication noncompliance in psychosis," *academic.oup.com*, Accessed: Nov. 24, 2023. [Online]. Available: <https://academic.oup.com/schizophreniabulletin/article-abstract/39/4/917/1916280>
  56. S. Mahaye *et al.*, "Medication adherence of psychiatric patients in an outpatient setting," *scholar.archive.org*, vol. 6, no. 9, pp. 608–612, 2012, doi: 10.5897/AJPP11.646.
  57. T. Eticha, A. Teklu, D. Ali, G. Solomon, and A. Alemayehu, "Factors associated with medication adherence among patients with schizophrenia in Mekelle, Northern Ethiopia," *PLoS One*, vol. 10, no. 3, Mar. 2015, doi: 10.1371/journal.pone.0120560.
  58. S. Chopra, P. Bansal, and P. Bansal, "Journal of Advanced Medical and Dental Sciences Research |Vol. 8|Issue 1|," *J Adv Med Dent Scie Res*, vol. 8, no. 1, pp. 184–186, 2020, doi: 10.21276/jamdsr.
  59. M. Sintayehu, G. Hibdye, Y. Dessalegne, N. Debero, and L. Bekan, "Prevalence of Drug Non Adherence and Associated Factors among Patients with Bipolar Disorder at Outpatient Unit of Amanuel Hospital, Addis Ababa," *researchgate.net*, p. 1, 2015, doi: 10.4172/2378-5756.S1-003.
  60. S. M. R. *et al.*, "Community outreach for untreated schizophrenia in rural India: a follow-up study of symptoms, disability, family burden and costs," *Psychol. Med.*, vol. 35, no. 3, pp. 341–351, 2005, [Online]. Available: [http://journals.cambridge.org/abstract\\_S0033291704003551%5Cnhttp://ovidsp.ovid.com/ovidweb.cgi?T=JS&PAGE=reference&D=emed7&NEWS=N&AN=2005125763](http://journals.cambridge.org/abstract_S0033291704003551%5Cnhttp://ovidsp.ovid.com/ovidweb.cgi?T=JS&PAGE=reference&D=emed7&NEWS=N&AN=2005125763)
  61. M. K. Iseselo, L. Kajula, and K. I. Yahya-Malima, "The psychosocial problems of families caring for relatives with mental illnesses and their coping strategies: a qualitative urban based study in Dar es Salaam," *BMC Psychiatry*, vol. 16, no. 1, 2016, doi: 10.1186/s12888-016-0857-y.
  62. P. Murthy, "Culture and alcohol use in India," *World Cult Psychiatry Res Rev*, pp. 27–39, 2015.
  63. S. M. Green, B. L. Levin, and R. Kirby, "Predictors of Premature Discontinuation from Behavioral Health





**Jahangir Khan et al.,**

Services: A Mixed Methods Study Guided by the Andersen & Newman Model of Health Care Utilization,” no. 27741582, p. 216, 2020, Accessed: Oct. 27, 2022. [Online]. Available: <http://myaccess.library.utoronto.ca/login?qurl=https%3A%2F%2Fwww.proquest.com%2Fdissertations-theses%2Fpredictors-premature-discontinuation-behavioral%2Fdocview%2F2394286736%2Fse-2%3Faccountid%3D14771%0Ahttps://librarysearch.library.utoronto.ca/openurl/01>





## Molecular Characterization of Naringinase Producing Bacteria *Pseudomonas resinovorans* RMCSJ-28

Anushka Tripathi<sup>1</sup>, Rachna Nara<sup>1</sup>, Nirmala Sehrawat<sup>2</sup>, Manoj Singh<sup>2</sup>, Anu Sehrawat<sup>1</sup>, Kumar Preet<sup>1</sup> and Mukesh Yadav<sup>2\*</sup>

<sup>1</sup>Ph.D. Student, Department of Bio-Sciences and Technology, M.M.E.C., Maharishi Markandeshwar (Deemed to be University), Mullana - Ambala, Haryana, India.

<sup>2</sup>Associate Professor, Department of Bio-Sciences and Technology, M.M.E.C., Maharishi Markandeshwar (Deemed to be University), Mullana- Ambala, Haryana, India

Received: 15 Feb 2024

Revised: 09 Mar 2024

Accepted: 29 Apr 2024

### \*Address for Correspondence

**Mukesh Yadav**

Associate Professor,

Department of Bio-Sciences and Technology,

M.M.E.C., Maharishi Markandeshwar (Deemed to be University),

Mullana- Ambala, Haryana, India

Email: mukeshyadav7@gmail.com



This is an Open Access Journal / article distributed under the terms of the **Creative Commons Attribution License** (CC BY-NC-ND 3.0) which permits unrestricted use, distribution, and reproduction in any medium, provided the original work is properly cited. All rights reserved.

### ABSTRACT

Naringin is a well known flavonoid, naturally present in the citrus fruits. It is also known for contributing to the bitterness of the citrus fruit juices. The naringinase (E.C.3.2.1.40) is an important enzyme complex that hydrolyses naringin and produces tasteless product naringenin. The naringin mediated bitterness therefore, can be reduced by naringinase mediated hydrolysis of naringin. In present investigations, naringinase producing bacterial strain (isolate RMCSJ-28) have been isolated from soil and characterized by 16s rRNA gene sequencing followed by phylogenetic analysis. The bacterial strain was found to be found to be *Pseudomonas resinovorans* and named as *Pseudomonas resinovorans* RMCSJ-28. This is first report on production of naringinase from *Pseudomonas resinovorans* and widens the pool of bacterial sources known to produce naringinase.

**Keywords:** Naringin, Naringinase, *Pseudomonas resinovorans*, 16S rRNA gene sequence, phylogenetic tree analysis

### INTRODUCTION

Naringin is a well known flavonoid naturally present in citrus fruits. Naringin is among the major causes of bitterness in citrus fruit juices. This flavonoid may cause interference during the citrus fruit juice processing [1]. The bitterness is undesirable in related food industry [2]. Therefore, the level of naringin should be reduced or removed



**Anushka Tripathi et al.,**

from the processed products [3]. Though, the level of naringin can be reduced through chemical methods, but the chemical method has several drawbacks [4]. Alternatively, naringinase enzyme may be used for hydrolysis of naringin into naringenin, a tasteless compound and therefore, have ability to lessen the citrus juices bitterness [5; 6]. Naringinase is an enzyme complex consisting two different catalytic activities including,  $\alpha$ -L-rhamnosidase (E.C. 3.2.1.40) and  $\beta$ -D-glucosidase (E.C. 3.2.1.21) activity that works in a sequential manner. In first step, naringin is hydrolyzed to rhamnose and prunin (glucoside) due to  $\alpha$ -L-rhamnosidase activity of naringinase, while in second step, prunin is hydrolyzed into naringenin and glucose due to  $\beta$ -D-glucosidase activity of naringinase [1; 7; 8; 9]. The rhamnosidase activity is considered necessary to eliminate bitterness [10]. Various studies have reported use of microbial naringinase for hydrolysis of naringin in citrus juices and promising results have been obtained [11]. A large number of enzymes have been reported from various bacterial sources for potent industrial applications [12; 13]. In this article, a naringinase producing bacterial strain has been isolated from soil and characterized as *Pseudomonas resinovorans* RMCSJ-28, by 16s rRNA gene sequencing followed by phylogenetic analysis. The bacterial strain was also found to produce naringinase in response to citrus peel powder. Further studies are required on production, characterization and application of naringinase produced from *Pseudomonas resinovorans* RMCSJ-28. This is the first report on *Pseudomonas resinovorans* RMCSJ-28 as source of naringinase.

## MATERIALS AND METHODS

### Isolation and screening of naringinase producing bacterial strains

The soil samples were collected from different fields of Haryana (India) with citrus plantations. The samples were stored in their natural state at 4°C, until further use [14; 15]. The soil samples were used to isolate naringinase producing bacteria [16; 17; 18; 19]. Appropriate serial dilution of soil suspension was done on the nutrient agar media (peptone, 0.5% w/v; yeast extract, 0.3% w/v; NaCl, 0.5% w/v; Agar, 1.5% w/v; pH 6.5) supplemented with citrus peel powder (1.0% w/v). The plates were incubated at 37°C for 24 hours. Fast growing, larger colonies were selected and cultured on nutrient agar media (peptone, 0.5% w/v; yeast extract, 0.3% w/v; NaCl, 0.5% w/v; Agar, 1.5% w/v; pH 6.5) containing naringin (0.05%; w/v) as selective substrate. Fast growing microbial colonies were selected, and preserved for screening. The isolated microbial strains were grown separately in nutrient broth (same as isolation media except agar, pH 6.5) supplemented with naringin (0.05%; w/v) for 24 hours at 37°C with continuous agitation of 150 rpm in an orbital shaker. The fermented broth was centrifuged (7000 rpm; 4°C; 10 minutes) to separate the cells from broth. The supernatant (cell free broth) was taken as crude enzyme and used to measure the naringinase activity [20; 21; 22]. Depending on the naringinase activity, microbial strain RMCSJ-28 was selected for further investigations and naringinase production.

### 16S ribosomal RNA gene sequence of naringinase producing bacterial strain RMCSJ-28 and phylogenetic analysis

The microbial strain RMCSJ-28 was confirmed to be bacteria with help of microscopic observation and characterized by 16s RNA gene sequencing followed by phylogenetic analysis. The 16S rRNA gene sequence of bacterial isolate RMCSJ-28 was obtained from geneOmbio Technologies Pvt. Ltd., Pune, India. The homology of the obtained 16S ribosomal RNA gene sequence (partial sequence) was determined using BLAST program of NCBI, USA (<https://blast.ncbi.nlm.nih.gov>) against the NCBI nucleotide database [23] and also aligned against the reference nucleotide sequences of the genera retrieved from the NCBI, GenBank using ClustalW program [24]. The phylogenetic tree was constructed using BLAST pairwise alignments with neighbor-joining method [25] with the help of online service provided by NCBI, USA (<https://www.ncbi.nlm.nih.gov>). The bacterial isolate was identified to be *Pseudomonas resinovorans* RMCSJ-28.

### Production of naringinase by *Pseudomonas resinovorans* RMCSJ-28

The media use for production of naringinase by *Pseudomonas resinovorans* RMCSJ-28 included yeast extract, 0.5% (w/v); peptone, 0.5% (w/v); NaCl, 0.5% (w/v); naringin, 0.15% (w/v); KH<sub>2</sub>PO<sub>4</sub>, 0.5% (w/v), MgSO<sub>4</sub>, 0.05% (w/v) and





Anushka Tripathi et al.,

MnSO<sub>4</sub> (0.001%, w/v). The media components were selected on the basis of earlier reports on naringinase production [18; 19; 21; 22; 26] and our preliminary results on naringinase production.

#### Citrus peel powder as raw substrate for naringinase production

Citrus peel powder of four citrus fruits namely, lemon, sweet lemon or mosambi, orange and kinnow at concentration of 1.0% (w/v) was studied as potent raw substrate for naringinase production from *Pseudomonas resinovorans* RMCSJ-28. Citrus peel was used in place of naringin, all other media constituents were used at their specified concentrations.

#### Assay for enzyme (naringinase) activity

Naringinase activity was measured on the basis of naringin hydrolysis as described by Davis [20] with minor modifications [21; 22]. Briefly, the fermented broth was centrifuged (7,000 rpm, 10 min, 4°C) and supernatant was used as crude enzyme. The typical assay mixture consisting 900 µl of naringin (0.05%, w/v) dissolved in sodium acetate buffer (0.1 M, pH 4.5) and 100 µl of supernatant was incubated for 1 hour at 50°C. Thereafter, an aliquot of 100 µl from the reaction mixture was taken and added to the 5 mL of diethylene glycol (90%, v/v) followed by addition of 100 µl NaOH (4 N) solution. After this, the reaction was incubated for 10 minutes at room temperature. The intensity of the developed yellow color was recorded at 420 nm in a UV-visible spectrophotometer. One unit of naringinase was defined as the amount of enzyme hydrolyzing 1 µmol of naringin per minute under the standard conditions of the assay.

## RESULTS AND DISCUSSION

#### Isolation and screening of naringinase producing microbial strains

Appropriate dilutions of soil samples were spread on citrus peel powder containing agar media and fast growing colonies were selected. The colonies were cultured on nutrient agar media containing naringin. Depending on growth and size of colony, different isolates were selected, and preserved for screening. On the basis of naringinase activity (2.5±0.031 IU/ml), isolate RMCSJ-28 (Rachna, Mukesh, Citrus Soil, Jhajjar, isolate 28) was selected for molecular characterization. Majority of the research work on naringinase production and related aspects has been conducted on fungal strains. In current study, isolation of naringinase producing bacterial strains was the main focus. Naringinase activity was used as the quantitative approach for secondary screening of the isolates. The bacterial isolate RMCSJ-28 was identified and characterized by performing 16S rRNA gene sequencing and phylogenetic analysis. Microbes are important source of industrial enzymes and soil is well known reservoir for isolation of useful microbial strains. Various authors have reported isolation of naringinase producing microbial strains from soil [26], citrus peel spoiled in air or soil [27] and other sources [28]. Promising naringinase producing bacterial strain has been isolated from the soil samples. Soil samples from fields having citrus plantation may be used to isolate the efficient naringinase producing microbial strains.

#### 16S ribosomal RNA gene sequence of bacterial strain RMCSJ-28 and phylogenetic analysis

The 16S rRNA gene sequence (599 bp) of bacterial strain RMCSJ-28 was analyzed for homology using nucleotide blast at NCBI, USA. The sequence revealed highest similarity with the *Pseudomonas resinovorans*. Therefore, the bacterial strain RMCSJ-28 was identified as *Pseudomonas resinovorans* and named as *Pseudomonas resinovorans* RMCSJ-28. The taxonomical information of the bacteria was found to be as follows: Bacteria; Pseudomonadota; Gammaproteobacteria; Pseudomonadales; Pseudomonadaceae; Pseudomonas. The phylogenetic tree was constructed (Figure 1) using BLAST pairwise alignments with neighbor-joining method of Saitou and Nei [25] with the help of online platform provided by NCBI, USA (<https://www.ncbi.nlm.nih.gov>). This is the first report exploring the naringinase producing potential of *Pseudomonas resinovorans*.





Anushka Tripathi et al.,

#### Submission of nucleotide sequence at GenBank, NCBI (USA) and accession number

The 16S ribosomal RNA gene sequence (partial) was submitted to GenBank (NCBI, USA) data base and has been assigned accession number OR346335.

#### Production of naringinase by *Pseudomonas resinovorans* RMCSJ-28 at shake-flask level

The media use for production of naringinase by *Pseudomonas resinovorans* RMCSJ-28 included yeast extract, 0.5% (w/v); peptone, 0.5% (w/v); NaCl, 0.5% (w/v); naringin, 0.15% (w/v);  $\text{KH}_2\text{PO}_4$ , 0.5% (w/v),  $\text{MgSO}_4$ , 0.05% (w/v) and  $\text{MnSO}_4$  (0.001%, w/v). The media components were selected on the basis of earlier reports on naringinase production [18; 19; 21; 22; 26] and our preliminary results on naringinase production. The mentioned media composition leads to higher production of naringinase ( $4.14 \pm 0.018$  IU/ml) as compared to screening ( $2.5 \pm 0.031$  IU/ml). Optimization of media is an important part of bioprocess technology and lead to higher production of enzymes and metabolites. Various authors have reported optimization of media components for higher production of naringinase using different microbial sources [4; 29]. Various media components have been shown to affect the naringinase production using different microbial strains including both bacteria and fungal strains. Various major carbon sources, nitrogen sources, yeast extract, peptone, metal ions, citrus peel powder,  $\text{KH}_2\text{PO}_4$ ,  $\text{MnSO}_4$ ,  $\text{MgSO}_4$ , naringin, NaCl and other media components have been found to affect the naringinase production by microbes [1; 18; 22; 26].

#### Citrus peel powder (CPP) as raw substrate for naringinase production

Peel powder of four citrus fruits (lemon, sweet lemon or mosambi, orange and kinnow; 1.0%, w/v) was investigated for production of naringinase at shake flask level. The bacteria *Pseudomonas resinovorans* RMCSJ-28 was able to produce naringinase in response to citrus peel powder. The citrus peel powder supported the production of naringinase, though the production was low as compared to naringin. Sweet lemon ( $3.07 \pm 0.039$  IU/ml) and orange ( $3.18 \pm 0.072$  IU/ml) resulted in higher production of naringinase as compared to lemon ( $2.77 \pm 0.054$  IU/ml) and kinnow peel powder ( $2.98 \pm 0.026$  IU/ml). Various reports describe the production of naringinase using citrus peel powder as substrate. Recently, Borkar et al. [30] reported the production of naringinase from *Aspergillus niger* van Tieghem MTCC 2425 using citrus waste peel. Similarly, Srikantha et al. [27] have reported optimal production of naringinase from *Aspergillus flavus* using citrus peel in solid state fermentation. Earlier, Puri et al. [18] also investigated the effect of citrus peel powder on production of naringinase from *Staphylococcus xylosus* MAK2. The results depicted the potential of citrus peel to be used as cost effective substrate. Further studies are requires on production of naringinase from *Pseudomonas resinovorans* RMCSJ-28.

## CONCLUSIONS

Naringinase is an important enzyme capable of hydrolyzing naringin into naringenin. Naringin is chiefly responsible for bitterness in citrus juices while naringenin is tasteless. Therefore, naringinase has significant applications in food industries particularly in de-bittering of citrus juices. In current studies, naringinase producing bacterial strain has been isolated from citrus plant rhizosphere and characterized as *Pseudomonas resinovorans* RMCSJ-28 by 16S rRNA gene sequence followed by phylogenetic tree analysis. Naringinase production was studied using naringin and citrus peel powder as inducer for production of naringinase. This is first report on naringinase production from *Pseudomonas resinovorans* and may provide useful insights in further investigations on naringinase production.

#### Conflicts of interests

The authors declare no conflict of interest.

## ACKNOWLEDGMENTS

Authors are thankful to the Head, Department of Bio-Sciences and Technology, M.M.E.C., Maharishi Markandeshwar (Deemed to be University) Mullana-Ambala (Haryana), India for providing necessary help and support.





Anushka Tripathi et al.,

## REFERENCES

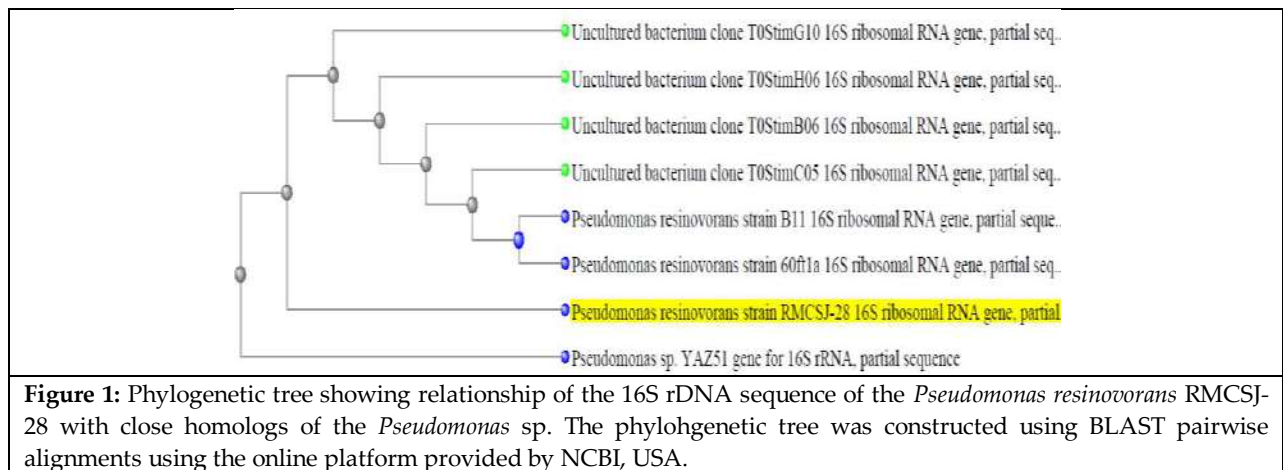
1. Yadav M, Sehrawat N, Sharma AK, Kumar V, Kumar A. Naringinase: microbial sources, production and applications in food processing industry. *J Microbiol Biotechnol Food Sci.* 2018; 8(1):717-720.
2. Awad GE, Abd El Aty AA, Shehata AN, Hassan ME, Elnashar MM. Covalent immobilization of microbial naringinase using novel thermally stable biopolymer for hydrolysis of naringin. *3 Biotech.* 2016 Jun;6:1-0.
3. Yusof S, Ghazali HM, King GS. Naringin content in local citrus fruits. *Food Chem.* 1990; 37(2): 113-121.
4. Puri, M., A. Banerjee, and U. Banerjee, Optimization of process parameters for the production of naringinase by *Aspergillus niger* MTCC 1344. *Process Biochem.* 2005. 40(1): 195-201.
5. Bodakowska-Boczniewicz J, Garncarek Z. Immobilization of naringinase from *Penicillium decumbens* on chitosan microspheres for debittering grapefruit juice. *Molecules.* 2019; 24(23):4234.
6. Muñoz M, Holtheuer J, Wilson L, Urrutia P. Grapefruit debittering by simultaneous naringin hydrolysis and limonin adsorption using naringinase immobilized in agarose supports. *Molecules.* 2022; 27(9):2867.
7. Chandler BV, Nicol KJ. Some relationships of naringin: their importance in orange juice bitterness. *CSIRO Food Res Quart.* 1975;35:79-88.
8. Habelt K, Pittner F. A rapid method for the determination of naringin, prunin, and naringenin applied to the assay of naringinase. *Anal Biochem.* 1983; 134(2): 393-397.
9. Ribeiro MH. Naringinases: occurrence, characteristics, and applications. *Appl Microbiol Biotechnol.* 2011; 90: 1883-95.
10. Puri M, Marwaha SS, Kothari RM, Kennedy JF. Biochemical basis of bitterness in citrus fruit juices and biotech approaches for debittering. *Crit Rev Biotechnol.* 1996; 16(2):145-155.
11. Falch EA. Industrial enzymes—developments in production and application. *Biotechnol Adv.* 1991; 9(4): 643-658.
12. Singh R, Singh R, Yadav M. Molecular and biochemical characterization of a new endoinulinase producing bacterial strain of *Bacillus safensis* AS-08. *Biologia.* 2013; 68(6): 1028-1033.
13. Singh RS, Yadav M. Enhanced production of recombinant aspartase of *Aeromonas media* NFB-5 in a stirred tank reactor. *Bioresour. Technol.* 2013; 145: 217-223.
14. Singh RS, Yadav M. Biochemical and molecular characterization of a new aspartase producer *Aeromonas media* NFB-5 from effluent of a fertilizer factory. *Curr Biotechnol.* 2012; 1: 185-193.
15. Malik K, Sehrawat N, Tripathi A, Nara R, Beniwal M, Singh M, Kumar S, Yadav M. Molecular characterization of yellow pigment producing bacterial strain as *Kocuria flava* KMSM-18 and fermentative production of yellow pigment. *Indian J Nat Sci.* 2023; 14 (81): 66790-66797.
16. Puri M, Kaur A. Molecular identification of *Staphylococcus xylosus* MAK2. *Appl Biochem Biotechnol.* 2010; 162: 181–191.
17. Radhakrishnan I, Sampath S, Kumar ST. Isolation and characterization of enzyme naringinase from *Aspergillus flavus*. *Inter J Adv Biotechnol Res.* 2013; 4: 208-212.
18. Puri M, Kaur A, Barrow CJ, Singh RS. Citrus peel influences the production of an extracellular naringinase by *Staphylococcus xylosus* MAK2 in a stirred tank reactor. *Appl Microbiol Biotechnol.* 2011; 89: 715–722.
19. Patil SV, Koli SH, Mohite BV, Patil RP, Patil RR, Borase HP, Patil VS. A novel screening method for potential naringinase-producing microorganisms. *Biotechnol Appl Biochem.* 2019; 66(3): 323-327.
20. Davis WB. Determination of flavonones in citrus fruits. *Anal Chem* 1947;19:476.
21. Puri, M., Kaur, A., & Singh, R. S. Response surface optimization of medium components for naringinase production from *Staphylococcus xylosus* MAK2. *Appl. Biochem. Biotechnol.* 2010; 162: 181–191.
22. Pavithra M, Prasanna DB, Saidutta MB. Production of naringinase by a new soil isolate of *Serratia* sp.: effect of different carbon and nitrogen sources. *Res J Biotechnol.* 2012; 7: 208-211.
23. Altschul SF, Gish W, Miller W, Myers EW, Lipman DJ. Basic local alignment search tool. *J Mol Biol.* 1990; 215(3):403-410.
24. Thompson JD, Gibson TJ, Higgins DG. Multiple sequence alignment using ClustalW and ClustalX. *Curr Protoc Bioinformatics.* 2003; 2-3.





Anushka Tripathi *et al.*,

25. Saitou N, Nei M. The neighbor-joining method: a new method for reconstructing phylogenetic trees. *Mol Biol Evol.* 1987; 4(4): 406-425.
26. Kumar A, Singh MK, Amena S. Optimization of naringinase production and its purification from *Micrococcus* sp. *Int J Pharm Pharm Sci.* 2015; 7: 269-272.
27. Srikantha K, Kapilan R, Seevaratnam V. Characterization of best naringinase producing fungus isolated from the citrus fruits. *Int. J. Biol. Res.* 2016; 4: 83.
28. Thammawat K, Pongtanya P, Juntharasri V, Wongvithoonyaporn P. Isolation, preliminary enzyme characterization and optimization of culture parameters for production of naringinase isolated from *Aspergillus niger* BCC 25166. *Agric Nat Resour.* 2008; 42(1): 61-72.
29. Chen D, Niu T, Cai H. Optimizing culture medium for debittering constitutive enzyme naringinase production by *Aspergillus oryzae* JMU316. *African J Biotechnol.* 2010; 9(31): 4970-4978.
30. Borkar V, Chakraborty S, Gokhale JS. Fermentative production of naringinase from *Aspergillus niger* van Tieghem MTCC 2425 using citrus wastes: Process optimization, partial purification, and characterization. *Appl. Biochem. Biotechnol.* 2021; 193(5): 1321-1337.





# A Conspectus of Cloud Computing Contrary to Recuperate the E-Learning Process

S.Bhavana<sup>1\*</sup> and T.Venkat Narayana Rao<sup>2</sup>

<sup>1</sup>Assistant Professor, Department of Computer Science and Engineering-the Internet of Things, Sreenidhi Institute of Science and Technology, (Affiliated to Jawaharlal Nehru Technological University Hyderabad) Hyderabad, Telangana, India.

<sup>2</sup>Professor and Head, Department of Computer Science and Engineerin- the Internet of Things (Affiliated to Jawaharlal Nehru Technological University Hyderabad) Hyderabad, Telangana, India.

Received: 23 Jan 2024

Revised: 09 Feb 2024

Accepted: 26 Apr 2024

## \*Address for Correspondence

**S.Bhavana**

Assistant Professor,

Department of Computer Science and Engineering- the Internet of Things,

Sreenidhi Institute of Science and Technology,

(Affiliated to Jawaharlal Nehru Technological University Hyderabad)

Hyderabad, Telangana, India.



This is an Open Access Journal / article distributed under the terms of the **Creative Commons Attribution License** (CC BY-NC-ND 3.0) which permits unrestricted use, distribution, and reproduction in any medium, provided the original work is properly cited. All rights reserved.

## ABSTRACT

As an aide in the training developing experience, online correspondences structures are used to work with e-learning, a kind of virtualized handling and distant learning. The rising of E-learning stages emerged profoundly in the past two years. Data searching for guidance information taking care of uses real factors made from web informational indexes to further develop the enlightening learning perspective for educational purposes while the developing experience is electronic. Dispersed processing is a sensible stage for supporting e-learning plans. It might be normally adjusted by offering a flexible response for changing PC resource usage for a really long time. It moreover works on all that to include data mining strategies in a spread environment while associating with gigantic e-learning datasets. A blueprint of the current status of disseminated registering is given in the survey and occasions of structure unequivocally planned for such a system. Furthermore, it in like manner discusses occasions of dispersed figuring and e-learning ways of thinking.

**Keywords:** E-Learning, Cloud Computing, Virtual Learning, SaaS, PaaS, IaaS

## INTRODUCTION

The broad use of the web, unquestionable level correspondence stages, and distance getting ready incited the movement of e-learning [2]. It utilizes different plans and abilities to give the best direction to homeroom heading.



**Bhavana and Venkat Narayana Rao**

These concrete Virtual course, messages and web joins, conversation sheets, and other learning stages, notwithstanding various things. The learning experience is better guided thanks to the internet based blend of students, content makers, and well-informed authorities. The undertakings' adaptability, openness, and clear entry are the most unmistakable advantages of learning with electronic mechanical congregations [3]. In information progress (IT), e-learning stages, all around called virtual appearance stages, are getting thoroughness, particularly taking into account the spread of Covivirus-19 and motorized progress. Different useful levels have related tries, as Huge Open Web based Courses (MOOCs), Record, Need to Learn, and the constructive Learning fleck at different schools, finished as remote learning plan by and large around the planet[3 ,4]. Virtual endeavors, which are completely kept up with by the e-learning point of view, have a noticeable ideal learning climate and are endlessly out more regular for people who can get their material online [6, 7].Numerous repercussions result from these degrees; For example, the design basics indispensable to offer an assistance to that different understudies simultaneously far outflank the constraints of standard web application clients. Additionally, essential advancement spikes generally coordinate with fast and dynamic changes in the interest for enlightening assets. An essentially further made structure than is conventionally guessed that for the learning affiliation ought to work regularly during these times will should answer demands without influencing other framework associations. Offering kinds of help with perspective on use and paying as the pay, overall, per-use structure for resources that are used is a decision.

The answer for these issues is conveyed figuring headway. Courshed enlisting was first proposed as a system for reducing down the expense of assessment while correspondingly expanding structure receptiveness and constancy [1, 8].From there on out, these objectives have framed into conveyed processing targets. However; there is a differentiation between the two to the extent that how the not entirely settled in each environment [28]. A figuring structure is all the more consistent concerning particular resources, and its essential job is to redesign PC system execution. On the other hand, the goal of circulated figuring is to permit clients to get different organizations without being have some familiarity with the fundamental system and give clear flexibility. It doesn't have a confined extent of organizations, including working with organizations and word taking care of [26]. It is pivotal for recollect that Help Organized Plan (SOA) is one of the places of help whereupon dispersed figuring is created. This sort of advancement is expected to help engineers in overcoming different dissipated legitimate enrolling hindrances, for instance, application blend, transpiring control, and safeguard the shows, as well as different various systems and shows, the wear and tear of hardware and programming to which we may be directly uncovered, and existing data structures [27]. Clients can't see the region of the handling establishment or a few other particular nuances since its capacities are totally made accessible as such [2]. The upsides of this new figuring perspective are clear conversely, with other fighting progressions. Cloud programming venders attempt to pass same or favored limits and capacities on over if the applications were stacked provincially on end patron machines, so clients don't need to consume cash on new hardware to use the application [14]. This cutoff limit and figuring drive draws in relationship to get their thing absolutely valuable quicker while requiring less associations from the IT office [15] by normally giving out IT resources (servers) taking into account assessment unusualness in virtual conditions.

Tremendous annals of student speculation with companions and teachers are moreover made by gigantic e-learning conditions like the ones discussed previously. These structures store basic data that hasn't been unequivocally reported. Estimations for data mining will be required [22]. Instructive data collection, or EDM, is a methodology that aid teachers and students with additional creating learning and direction in the continuous environment [17]. The fundamental point of convergence of this field is on coming up with novel methodologies for data assessment considering the recently referenced current tutoring framework activity. The improvement of shows and assets that will work with and overhaul learning is an indisputable objective of this methodology, which comparably desires to get a more critical impression of understudy execution. PC based tutoring systems that are planned to help with teaching and learning have a prompt relationship with this method. This capacity limit and figuring drive empowers organizations to get their product completely functional quicker while requiring fewer administrations from the IT office [15] by intuitively doling out IT resources (servers) in light of calculation intricacy in virtual conditions. Large repository of student taking part with peers and teachers are also produced by massive e-learning environments like the ones discussed earlier. These systems store significant data that hasn't been explicitly declared. Algorithms for



**Bhavana and Venkat Narayana Rao**

data mining will be required [22]. Instructional data collection, or knowledge discovery edm, is a method that helps teachers and students improve learning and instruction in the current environment [17]. The primary focus of this field is on developing novel methods for data analysis based on the current education system activity that is taking place. The improvement of conventions and assets that will work with and upgrade learning is a definitive objective of this procedure, which likewise expects to acquire a more profound comprehension of understudy execution. PC-based tutelage systems that are designed to help with instructing and learning have a direct connection to this strategy. These state-of-the-art tools track students' progress and provide constructive criticism so they can improve. To expand and enhance knowledge, the EDM approach works in tandem with an instructional paradigm. Thanks to cloud hosting, which is made possible by the size and adequacy expansions in computer's ability, data mining algorithms may now be adopted and applied into any database [20]. Conversely, some other approaches to data mining aren't as scalable. As this issue becomes more and more relevant, businesses and scholars are starting to take notice of it. Worldwide educational institutions are shifting to primarily or fully online instruction as a result of the COVID-19 pandemic. The primary challenge is providing sufficient and secure resources to support the E-growing experience. This research attempts to audit distributed computing administrations in order to find ways to help teachers take advantage of cloud administrations' advantages, like security, adaptability, and versatility, in order to enhance the E-growing experience. The rest of this paper is structured as follows. Section 2 covers the basic Cue of Cloud Computing. Section 3 discusses about E-LEARNING CHORE AND CLOUD COMPUTING. Section 4 describes the PROSPECT WAVER FOR E-LEARNING AND CLOUD COMPUTING. Section 5 Concludes the paper.

**Basic Cue of Cloud Computing**

All of the previously presented analyses had cloud computing as their main focus. The researchers are able to provide a detailed presentation of the concept because of the qualitative analysis that forms the basis of the review. In order to address the research, a literature review offers an overview, synopsis, and analysis of the topic. It examines books, scholarly journals, and any other relevant assets to a specific matter, concept, or area of study. Thanks to the internet, a plethora of resources and services are now accessible, such as servers, databases, software, data storage, networking, and cloud computing. The notion of Service-Oriented Architecture (SOA) is presented here. SOA is a rationally and technologically integrated framework that supports and integrates different kinds of facilities into an integration framework. In cloud computing terms, a service is simply a function that has been packaged in some way to facilitate standardization and structured, automated customer delivery. A service can be any component, such as software used for mail management, user identity verification, database administration, operating system usage control, and so forth, or hardware-related components like processing speed or storage capacity. Stated differently, the paradigm of cloud computing points to a shift in the way that technological applications are used to resolve problems [38].

The use and combination of services forms the foundation of the application. generate. Although traditional methods, such as distributed systems, depend on processor algorithms, the system's operation relies on the integration and use of services. Stated differently, this facilitates the processes of scalability, dependability, flexibility, and adaptation. For instance, during a surge in requirements of resources caused by an hike in the number of customers or computational load, multiple precedence's for a specific service may be launched in order to maintain the application's proper response time for customers. Because of the drop in demand, resources ought to be made available. Every decision is made with the customer in mind. Some of the most ambiance of cloud computing are its high degree of affinity, low connection requirements, and protocols that isolate the vendors environment from compilation [41]. Instead of having distinct boundaries, a SOA's operations are frequently divided into levels or layers. Certain components leverage services from lower tiers to extend the capabilities available to higher tiers. These divisions might also have different corporate structures, architectural styles, and other attributes. The structure of what is depicted is comprised of three primary layers, which vary based on the type of course of action being advocated. Coatings fall into three main categories. Together, they provide structure to what is shown, contingent on the kind of action being advocated. Coatings fall into three main categories. The most popular of these is a web-based storage system that arranges data into "files" or "blocks". A collection of registers, columns, or other entities that carry out operations and offer services is called a compute cloud. Large projects have benefited from the cloud



**Bhavana and Venkat Narayana Rao**

computing model [25]. It is well known that a large number of applications in science and business require a high processing power. Continuous data flows require an elevated communication link because they manage massive volumes of data in stable systems. There are numerous subsets within the framework's administrative structure. These frameworks are typically grouped based on the level of complexity they provide to the framework user. As demonstrated in Figure 1, this method accurately identifies three different levels of Infrastructure as a Service, or Infrastructure as service, provides basic components such as PC frameworks and equipment reflection, as well as infrastructure components such as server farms, network innovation, memory, and registration [26]. IaaS is analogous to a single PC platform because the working framework is in charge of managing and maintaining the framework's assets. Instead of purchasing and configuring its own entire processing infrastructure, the IaaS customer rents computing resources from the IaaS provider.

Customers only pay for the services they use because services are constantly assessed based on actual use. When the workload is light, distributed computing uses (and spends) less resources due to its dynamic versatility. IaaS can provide assistance when it is most urgently needed to resolve a particular client's problems. The majority of administrative agreements have a maximum amount that a client is not permitted to exceed. Typical IaaS clients include professionals and scholars who have experience with research. The wide range of support provided by IaaS enables these clients to configure investigations and interpret data to a truly unimaginable extent. Versatile PC Cloud (EC2) from Amazon is arguably one of the most well-liked IaaS providers at the moment. Google Compute Motor, Rack Space, and Windows Azure are a few other well-known IaaS companies. An integrated software package with all the components required to develop apps during the design and delivery stages is included in each of the previous analyses [23, 7]. IaaS services enable developers to connect indirectly to IaaS infrastructure and, consequently, the necessary architecture; PaaS providers do not supply infrastructure directly [13]. Apps and apps in their entirety can be developed using Platform as a Service (PaaS). Leading providers of Platforms as service-distributed computing services include "Google Application Motor," "Amazon Web Administrations," "Heroku," and "Open Shift-RedHat."etc. As web usage increases, the most advanced method of utilizing cloud services is called Programming as a Help (SaaS) [24]. Certain organizations enabled anyone to access the applications that served as client connection executives frameworks (CMSs) starting from the host elements of the stage as a service[14].

**E-LEARNING CHORE AND CLOUD COMPUTING**

Aweb based-learning frameworks are evolving at a rapid speed as a result of the suspension of local classes, a considerable increase in the number of understudies, instructional content, services offered, and assets easily accessible [4,18].In terms of content and data conveyance and recovery, cloud registration is what is going on here. Several educational institutions are now adopting cloud innovation. Distributed computing frameworks and e-learning framework design have a considerable impact on the e-learning biology's drawn out strength, agreement, asset productivity, and consistency [17]. The designers of [16] created a figure illustrating the effects and implications of establishing e-learning deals with any ramifications relating the authorized registering system. Because the program may be accessed at any time and from any location, web developers will initially be in high demand. By not paying for programming, planning, or hosting the board, the endorser saved money. As a result, the firm will spend less overall, send faster, and employ fewer IT professionals. Many educational institutions can benefit from using a SaaS server. Several scholars have previously researched the technological advantages of a cloud-based education. A hard disk is not required to transmit and backup data across devices. Students' learning can be saved in a reservoir and grown with them for as long as they like. Almost no data is lost in the event of a failure. Students can use virtualized programs to view and edit files from several places. Because all users have access to a single database in the cloud, cyber security modifications may be examined and implemented more effectively [22]. As a result, while additional study is expected to examine how cloud-related teaching methods or learning objectives are evaluated, two PC pools are used for guidance: a C pool with a thin client, a server pool running the microkernel, and a private cloud architecture based on v sphere. Not only can alert data be saved, but Android smartphones that function as rest alarms also allow for the observation of proficiency and setup through the use of keep notes. For the hardware host, the microkernel is essential. Virtual machines cannot interfere with one another when a hypervisor allocates



**Bhavana and Venkat Narayana Rao**

resources to each component as needed. A that operates directly on the concealed equipment is a superior option in this case. This layer meets the requirements of PaaS and SaaS cloud users and acts as an interface to the external world. Educational institutions are focusing increasingly on e-learning and cloud technology integration due to the growing demand for ongoing education. It was regarded by almost all educational institutions as a beneficial and effective replacement for e-Learning. On the other hand, the general characteristics of the cloud are linked to social responsibility and beneficial writing instruction [20]. Similar to previous group Google Docs projects, the authors of [21] look at how important and responsible students think they are.

**PROSPECT WAVER FOR E-LEARNING AND CLOUD COMPUTING**

An e-learning system hosted on the cloud can greatly mitigate the drawbacks of conventional on-site computer labs and platforms. An e-learning system hosted on the cloud can greatly mitigate the drawbacks of conventional on-site computer labs and platforms. The instructor needs to see an example of how to assign resources from the cloud and handle student accounts. It is also important to provide directions to students on how to retrieve and usage of the cloud-based materials for the course. By utilizing the inherent advantages of cloud technology—such as reduced costs, increased accessibility, fault tolerance, and distant connectivity—e-learning may be seamlessly integrated into a cloud-based system. The benefits of cloud technology can be exploited with. A migration feasibility assessment must include user requirements, the availability of existing IT infrastructure, and a cost-benefit analysis. Despite the fact that network and speed have improved dramatically over the last 10 years to a tolerable level around the world, a slow net connection can fundamentally impair cloud-based training and web-learning. When services and data are available from cloud datacenters that are not provincial in nature, the problem gets worse. Customers and learners using cloud-based e-learning platforms can experience major delays as a result of this problem. It is possible, though doubtful, that this object will involve the cloud in some way. The key to accomplishing the objective of this issue might lie in devices that closely mimic the equipment environment. Utilizing resources and software from both on-premises and cloud-based systems is recommended for hybrid clouds.

**CONCLUSION**

The analysis summary states that using cloud services for e-learning is a good idea because it enables teachers to use the security, flexibility of the cloud to represent the main component of e-learning, which is instruction that can be accessed from any device. at any time, and from anywhere. An effective learning environment with specialized knowledge that is easy to adapt to the present educational paradigm allows us to fully utilize the opportunities it affords. Software and hardware savings must be emphasized. It offers a greater selection of good educational possibilities for a lower license fee. When it comes to modifying and personalizing learning for each user, today's e-learning services and systems fall short. This method results in learners receiving general e-learning that is inappropriate for their need. Further r & dare required because cloud based comprehensive learning needs to be used and developed over a wide range of topic areas. Most contemporary systems rely on interactions between instructors and students to enhance the quality of each student's educational experience. It should be feasible to integrate cloud-based web-learning services like online chatting, video based calls etc., .Contemporary cloud-based e-learning frameworks make up for these drawbacks by using Skype, email, and voice-over-IP. This remains an issue for the vast majority of cloud-hosted services. When assessing the extent of an issue, there are multiple factors to take into account. According to new research, academics have a wealth of materials that could contribute in the development and implementation of cloud-based e-learning frameworks. Future research will evaluate the consequences of transitioning to a cloud-web-learning environment on a range of aspects such as access speed and educational quality. Meetings, teams, classroom and Zoom are all great resources for facilitating, supervising, and managing online learning.





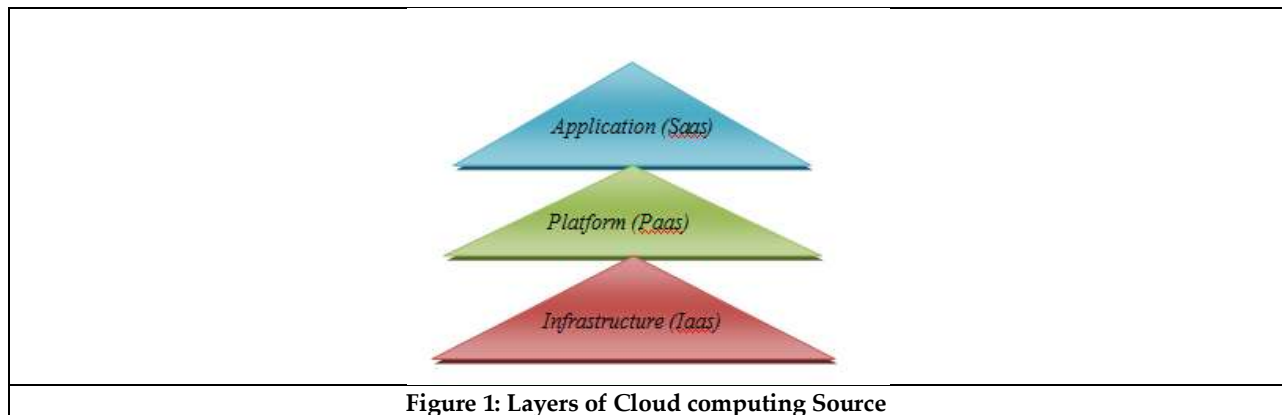
## REFERENCES

1. Alam, T. (2021). Cloud Computing and its role in the Information Technology. IAIC Transactions on Sustainable Digital Innovation (ITSDI), 1, 108-115.
2. Clark, R. C., & Mayer, R. E. (2016). E-learning and the science of instruction: Proven guidelines for consumers and designers of multimedia learning: John Wiley & sons.
3. Kaisara, G., & Bwalya, K. J. (2021). Investigating the E-Learning Challenges Faced by Students during COVID-19 in Namibia. International Journal of Higher Education, 10(1), 308-318.
4. Khan, R. M. I., Radzuan, N., Farooqi, S., Shahbaz, M., & Khan, M. (2021). Learners' Perceptions on WhatsApp Integration as a Learning Tool to Develop EFL Spoken Vocabulary. International Journal of Language Education, 5(2), 1-14.
5. Khan, R. M. I., Radzuan, N. R. M., Shahbaz, M., & Ibrahim, A. H. (2018). EFL Instructors' Perceptions on the Integration and Implementation of MALL in EFL Classes. International Journal of Language Education and Applied Linguistics, 39-50.
6. AlKhunzain, A., & Khan, R. (2021). The Use of M-Learning: A Perspective of Learners' Perceptions on M-Blackboard Learn.
7. Galić, S., Lušić, Z., & Stanivuk, T. (2020). E-learning in maritime affairs. Journal of Naval Architecture and Marine Engineering, 17(1), 38-50.
8. Mell, P., & Grance, T. (2011). The NIST definition of cloud computing.
9. Kundu, K., & Sharma, M. (2020). Data Mining and Techniques. Emerging Trends in Big Data, IoT and CyberSecurity, 33.
10. Aldowah, H., Al-Samarraie, H., & Fauzy, W.M. (2019). Educational data mining and learning analytics for 21st century higher education: A review and synthesis. Telematics and Informatics, 37, 13-49.
11. Ziani, A., Sadouq, Z. A., & Medouri, A. (2019). Use of cloud computing and GIS on vehicle traffic management. International Journal of Intelligent Enterprise, 6(2-4), 382-392.
12. Manzoor, D., Ali, A., & Ahmad, A., Cloud and Web Technologies: Technical Improvements and Their Implications on E-Governance. International Journal of Advanced Computer Science and Applications, 2014.5(5): 196-201.
13. Pahl, C. (2015). Containerization and the PaaS cloud. IEEE Cloud Computing, 2(3), 24-31.
14. Marinescu, D. C. (2017). Cloud computing: theory and practice: Morgan Kaufmann.
15. Haji, L. M., Zeebaree, S., Ahmed, O. M., Sallow, A. B., Jacksi, K., & Zeabri, R. R. (2020). Dynamic resource allocation for distributed systems and cloud computing. TEST Engineering & Management, 83, 22417-22426.
16. Masud, M. A. H., & Huang, X. (2011). ESaaS: A new education software model in E-learning systems. Paper presented at the International Conference on Information and Management Engineering.
17. Bora, U. J., & Ahmed, M. (2013). E-learning using cloud computing. International Journal of Science and Modern Engineering, 1(2), 9-12.
18. Khan, R. M. I., Shahbaz, M., Kumar, T., & Khan, I. (2020). Investigating Reading Challenges Faced by EFL Learners at Elementary Level. Register Journal, 13(2), 277-292.
19. Palos-Sanchez, P. R., Arenas-Marquez, F. J., & Aguayo-Camacho, M. (2017). Cloud computing (SaaS) adoption as a strategic technology: Results of an empirical study. Mobile Information Systems, 2017.
20. Hashem, I. A. T., Yaqoob, I., Anuar, N. B., Mokhtar, S., Gani, A., & Khan, S. U. (2015). The rise of "big data" on cloud computing: Review and open research issues. Information systems, 47, 98-115.
21. Blau, I., & Caspi, A. (2009). What type of collaboration helps? Psychological ownership, perceived learning and outcome quality of collaboration using Google Docs. Paper presented at the Proceedings of the Chais conference on instructional technologies research/
22. Bhardwaj, A., & Goundar, S. (2019). A framework to define the relationship between cyber security and cloud performance. Computer Fraud & Security, 2019(2), 12-19.
23. Fernandez, A., Peralta, D., Herrera, F., & Benítez, J. (2012). An overview of e-learning in cloud computing. Paper presented at the Workshop on Learning Technology for Education in Cloud (LTEC'12).



**Bhavana and Venkat Narayana Rao**

24. Khan, I., Ibrahim, A. H., Kassim, A., & Khan, R. M. I. (2020). Exploring The EFI Learners' Attitudes Towards the Integration of Active Reading Software in Learning Reading Comprehension at Tertiary Level. *MIER Journal of Educational Studies Trends & Practices*, 248-266.
25. Pekane, A. (2015). Adoption of cloud computing to enhance project management processes and outcomes in South Africa in the private sector. Cape Peninsula University of Technology.
26. Srivastava, P., & Khan, R. (2018). A review paper on cloud computing. *International Journal of Advanced Research in Computer Science and Software Engineering*, 8(6), 17-20.
27. Sunyaev, A. (2020). *Cloud computing Internet computing* (pp. 195-236): Springer.
28. Varghese, B., & Buyya, R. (2018). Next generation cloud computing: New trends and research directions. *Future Generation Computer Systems*, 79, 849-861.
29. Bora, U. J., & Ahmed, M. (2013). E-learning using cloud computing. *International Journal of Science and Modern Engineering*, 1(2), 9-12.
30. Khan, R. M. I., Shahbaz, M., Kumar, T., & Khan, I. (2020). Investigating Reading Challenges Faced by EFL Learners at Elementary Level. *Register Journal*, 13(2), 277-292.
31. Khan, R. M. I. (2020). Exploring The EFI Learners' Attitudes Towards the Integration of Active Reading Software in Learning Reading Comprehension at Tertiary Level. *MIER Journal of Educational Studies Trends & Practices*, 248-266.
32. Pekane, A. (2015). Adoption of cloud computing to enhance project management processes and outcomes in South Africa in the private sector. Cape Peninsula University of Technology.
33. Srivastava, P., & Khan, R. (2018). A review paper on cloud computing. *International Journal of Advanced Research in Computer Science and Software Engineering*, 8(6), 17-20.
34. Sunyaev, A. (2020). *Cloud computing Internet computing* (pp. 195-236): Springer.
35. Varghese, B., & Buyya, R. (2018). Next generation cloud computing: New trends and research directions. *Future Generation Computer Systems*, 79, 849-861.

**Figure 1: Layers of Cloud computing Source**





## Ensuring Children's Healthy Development: Role Transition of Primary School Teachers for Health Promotion

Jogy George<sup>1\*</sup> and N. R. Suresh Babu<sup>2</sup>

<sup>1</sup>Research scholar, Department of Sociology, Bharathiar University, Coimbatore, Tamil Nadu, India.

<sup>2</sup>Professor, Department of Sociology, Bharathiar University, Coimbatore, Tamil Nadu, India.

Received: 23 Jan 2024

Revised: 09 Feb 2024

Accepted: 26 Apr 2024

### \*Address for Correspondence

**Jogy George**

Research scholar,

Department of Sociology,

Bharathiar University,

Coimbatore, Tamil Nadu, India.

Email: jogygeorge96@gmail.com



This is an Open Access Journal / article distributed under the terms of the **Creative Commons Attribution License** (CC BY-NC-ND 3.0) which permits unrestricted use, distribution, and reproduction in any medium, provided the original work is properly cited. All rights reserved.

### ABSTRACT

Healthy Development of children is an indispensable objective of the primary education system in contemporary society. In schools, health promotion activities and health education were strengthened and reframed to serve the same purpose. In all these efforts, one stakeholder who has a pivotal role to play in the successful achievement of children's healthy development are primary school teachers. As they are the persons with whom children spend most of their time besides parents, they are able to transfer valid health knowledge to children and guide them to internalize it. The current scenario, which indicates the elevated health risk susceptibility of children, generates new expectations from the primary school teachers. The current study will focus on the role transition in primary school teachers in accordance with new role expectations that force them to engage in the health-related issues of students and utilize their medical gaze to contribute in identifying, preventing and improving health issues in the students. The current paper will utilize recent literature in corresponding areas. The results of the study brought spotlight on the shifting dynamics of teacher-student relationship with respect to the health promotion framework.

**Keywords:** Primary school teachers, healthy development, Role transition, Health promotion, Public health.

### INTRODUCTION

In the case of primary education, it is crucial to pave a robust foundation among the children to gain academic excellence. However, it should not overshadow the essentiality of addressing the overall development of the children



**Jogy George and Suresh Babu**

(Banerjee & Kiran, 2022). Clinical reports show that there is a massive rise in the cases of anxiety, stress, behavioural disorders and depression among children (Ma et al., 2021). Also, it should be noted that children are still in the early stages of developing their immune systems. Reading this within the line of health vulnerabilities can give a broad idea of the severe harm the situation poses (Singh et al., 2020). The children are more prone to ill-being due to their weak immunity, changes in environmental conditions and changing family dynamics. This has clear implications on their physical, social and mental well-being (Pietrabissa & Simpson, 2020). Considering the scenario, there should be more efforts in ensuring the healthy development of children along with academic goals. The healthy development of primary school students ideally aims at providing the students with sufficient health care, tackling health barriers and providing a safe and secure school environment where the students can be comfortable (Lowry et al., 2021). Children are exposed to the health promotion activities in formal educational settings during the recent times, especially after the pandemic period; the impact of the pandemic was so massive that general concern regarding health was elevated. Thus, students should be evaluated appropriately at the physical, psychological, behavioural and social levels. Successfully attaining this goal is a hefty task, requiring the joint effort of concerned stakeholders at many levels (Saxena et al., 2021). Thus the need for health promotion in primary school in order to achieve health goals concerning the students is more than ever.

Primary schools have to rigorously upgrade their resources and capacities to constitute a setting that can minimise the health risks of the children and contribute to the betterment of living and learning outcomes (Brivio et al., 2021). Programmes for health promotion in schools are strategic tools in public health as it has the potential to identify, address and create awareness regarding health issues of children, who are one of the most vulnerable sections with respect to health. The joint effort between schools, community, and medical authorities is inevitable in setting up perfectly working health promotion schools (Husseini et al., 2022). A school environment is to be maintained in such a way that it is free of harmful bacteria, viruses, and toxic chemicals. The availability of medical expertise to train the stakeholders within the schools to deal with the students, management and community who provide economic and social support etc., are essential requirements in school health promotion (Brivio et al., 2021). Along with this, primary school teachers, with whom the children spend most of their time, become a significant factor in health promotion activities in schools. They can act as a significant link between children and public health (Al-Amari, 2007). The role of teachers in a teacher-centered formal education system is to act as a catalyst in developing future generations. Thus development should not be restricted to academic outcomes. Earlier, the education system overburdened teachers with a curriculum focused on cognitive development, and there is no more time left to overlook the impact of unmet needs on the well-being of students (Weeks, 2000). The health promotion framework resulted in re-formulating what is expected of a primary school teacher, especially in the case of healthy development of children. The current paper will discuss increasing concerns regarding the health of school-going children and role expectations from primary school teachers in health promotion concerning the healthy development of children.

**METHODS**

An extensive literature search was conducted using online databases Web of Knowledge, OECD, JSTOR, SAGE, and PubMed, in the areas of social sciences, education and health. To build an all-encompassing review, additional online databases such as Google Scholar and Research Gate were also employed. In order to identify appropriate sources for the review, key search words such as 'Primary school teachers', 'healthy development', 'Role transition', 'Health promotion', and 'Public health' were employed. The synonyms and derivatives of these key search words were utilised to maximise the pool of resources which comes under the domain of the study. Furthermore, an inclusion criteria was fixed to narrow down and select the literature which are compatible with the purpose of the study. The inclusion criteria are:

- 1) The literature should deal directly either on,
  - a) Role of teachers in health promotion
  - b) Role of teachers in ensuring well being of students



**Jogy George and Suresh Babu**

2) The full text of the literature should be available in English language  
3) The literature should be published after 1st January 2019, so that the selected studies remain relatively recent.  
Even though both qualitative and quantitative papers were considered for review, from both types only qualitative data with significant was cautiously sorted out. After the refining of literature, it was subjected to manual thematic analysis.

**RESULTS**

The study extracted four dominant themes regarding new role expectations for teachers to ensure healthy development of children. It includes 1) improved health awareness, 2) role in health monitoring, 3) role in health training, and 4) role as public health worker. Each theme discussed a distinct aspect of new role expectations with respect to healthy development of children.

**Theme 1: Improved health awareness of primary school teachers**

Health awareness of an individual can be defined as a conglomerate of ideas and knowledge that a person holds regarding health, health practices, health needs, health services, preventive measures for health issues etc. (Chavan & Chavan, 2018). With the increasing health challenges in contemporary society, teachers are expected to improve their general health awareness. Specifically, primary school teachers, along with gaining general health awareness, are expected to build awareness regarding childhood life stages of health (Blake, 2020). Teachers, as members of society, have formed their health preferences from their own socialisation. But, there is a need for accurate and standardised awareness among primary school teachers to understand the physical, behavioural, social and psychological well-being issues of the children (Husain et al., 2015). This can be achieved by incorporating health promotion topics in teacher training programmes, coursework regarding the health of students at regular intervals of the academic year and engagement with expert health professionals (Nubani Husseini et al., 2022).

**Theme 2: The role of primary school teachers in health monitoring of children**

Children spend around 10 hours on a daily average within the classroom and school surroundings. It becomes the responsibility of teachers and school administration to look after the children during this period. Prioritising the well-being of the students, teachers are expected to monitor the academic and extracurricular activities of the children (Gant Bradley, 2014). The teachers should intervene in maintaining the appropriate distance between students in situations such as the presence of communicable diseases and epidemics (Jaspers, 2019). During the free time and breaks, teachers should monitor children that they are not coming in contact with harmful substances in school compounds, there is no bullying, and whether they are consuming unhealthy food items. During the sessions of physical activities, teachers should supervise the students in order to minimise physical injuries (Mitic et al., 2012).

**Theme 3: Primary school teachers as health trainers**

The role of a health trainer is to assess the lifestyle and health conditions of an individual and provide practical tips and action plans to improve their health (Tilson & Gebbie, 2004). Teachers have the opportunity to evaluate the nutrition, hygiene and behaviour of the students (Kamala Kumari, 2021). From the close interaction in the classroom, teachers can understand health issues affecting individual children. Primary school teachers can identify which students are undernourished, anaemic, which are the students who are not following hygienic practices, and whether students are showing some tendency of social incompetence and isolation (Hu et al., 2020). Primary school teachers can act as health mentors for students by ensuring that students are getting enough nutrition during the food breaks in school, advising the children to follow hygienic practices and improving the social competence of the children by encouraging them to be part of group activities and strengthening their interaction skills (Pokharel & Adhikari, 2020).



**Jogy George and Suresh Babu****Theme 4: Primary school teachers as public health workers**

Public health considers the generalised health of a given population in a community. This generalisation is to understand the general trends with respect to the health of the population (Lowry et al., 2022). The aim of conceptualising public health is to ameliorate the health of the concerned population and also by designing frameworks for preventing health problems via appropriate state-supported facilities and policies. Any employee who works to realise this goal can be called a public health worker. In India, about 25 percent of the population is aged less than 14 hence child public health has to be taken very seriously. By improving the participation of primary school teachers in students' health, they are also becoming part of a wider framework of public health (Campbell, 2020). As primary school teachers can observe and generalise what the recurring health problems and hurdles to well-being in children are, they can transfer this information to the concerned health regulatory body. Primary school teachers can also add to the betterment of policy-making regarding school health promotion by sharing their first-hand experience with the children (Kumar & Scuderi, 2000)

**FINDINGS**

The study identified four major themes regarding new role expectations for teachers to ensure healthy development of children. It includes 1) improved health awareness, 2) role in health monitoring, 3) role in health training, and 4) role as public health worker. The themes reflect discrete aspects of conceptualisation in relevant literature regarding new role obligation of primary school teachers. Majorly it focuses on aspects such as role transformation at the level of comprehension, classroom practices and at a larger level to public health. The first theme which discussed about improved health stressed the point that, in an efficiently working health-promoting school system, the teachers should be given enough time to update themselves with new knowledge, techniques and methods to readapt (Hwang & Chae, 2018). The teachers should be guided with health-friendly infrastructure, accessible health professionals, training sessions regarding student health and platforms where teachers can learn something new and raise their concerns (Núñez Díaz, 2020). Thus, along with time, teachers should also be assisted with space, which can improve their role performance (Charner-Laird, 2022). The second theme deals with the importance of observation and assessment of health issues among children by teachers. Various studies identified teachers as the second highest determining factor in the development of individuals after parents, with whom children spend most of their time apart (Ferindistika Putri et al., 2019). This can be understood from the direct association between teachers' attitudes and interaction with the students. The appropriate intervention of teachers has an exponentially positive impact on students with respect to their personality and performance (Zhou, 2021).

Considering the changes happened in the pandemic situation and as preparation for post-pandemic health promoting interventions, teachers require intense training in new models for classroom management, student well-being and student supervision (Plakhotnik et al., 2021). The academic duties of primary school teachers should be in balance with their participation required to ensure the healthy development of the children. (Lopes, 2017). The teacher should be able to read the well-being of the students from their behaviours and interaction within the classroom, and it is the teachers' duty to use verbal, visual and physical cues to manipulate students' classroom issues (Zhou, 2021). Pertinently teachers should know which health issues of students are manageable by the teachers themselves and which should be transferred further to be managed by concerned external agents (Sadaf & Huma, 2021) The third theme deals with the need of teachers being health trainers. The health-promoting primary schools should be able to construct a sustainable 'socio-ecological system' for the students. The teachers act as a component which will contribute to the maintenance of this 'socio-ecological system'. The intra-role transition of primary school teachers as a major socially influencing component in the healthy development of children requires an enhancement or development of 'teacher expertise' in the field of student health (Louis, 1980). Moreover, the characteristics of teaching have to be transformed into an 'emotional practice' in which the well-being of students will be marked as an evident priority. The genuine usage of 'professional capital', which is the knowledge and relation networks that they formed within their profession, and the 'social capital', which is a network of social relationships, can help primary school teachers in the process of building the desired 'teacher expertise'. The teachers



**Jogy George and Suresh Babu**

are vested with a huge responsibility, and they will be successful in the venture if they successfully improve the intrinsic factors such as 1) the caring nature of the teacher that wishes to improve the well-being of children, 2) usage of positive cue to control student behaviour and consequences, and avoiding harmful control mechanism such as corporal punishment, 3) the feeling of accountability as a teacher for student's success (Brault, 2021). The final theme conceptualises teachers as an important stakeholder in public health. As the education system collaborates with public health institutions to find the general health issues faced by the children, the teachers can act as a guide who creates awareness among the students, screeners who identify the potential issues in a student and a manipulator who can modify the health behaviour of the students. This transition in the role requires new learning from the part of the teachers and should be supported by parents, policymakers, management etc. (Hollander, 2021). The health of the children is such a delicate matter to deal with, and it is an alarming question that how much authority should be vested in primary school teachers to control the development of children. The aim of the reinforced role of teachers is to give the children scope for achieving healthy development.

Whether the involvement of primary school teachers should be restricted only to the classroom? Should they be given an active role in school administration for health promotion? or should they have a say in matters of policies regarding student health at a societal level? Primary school teachers should be given a clear-cut idea regarding how much authority or influence a teacher has in health promotion activities in school. Giving primary school teachers appropriate time, resourceful space and defined authority can help them accelerate their role transition. No role in society remains static, and they get modified with time. The health promotion framework and post-pandemic concerns have brought new expectations from society towards the role of teachers (Jourdan et al., 2016). The new role expectations are more focused on the involvement of teachers in the health and well-being of the student. With these new role expectations, teachers are undergoing an intra-role transition by which they have to reinterpret their duties and obligations with respect to the students' healthy development (Biddle, 1986). Hence, revising the role of teachers is a necessity of the time. It should be encouraged by providing all the necessary backing from the concerned stakeholders in accelerating their role transition and improving their efficiency to act as a support mechanism for students (Rodríguez-Triana et al. 2020).

**CONCLUSION**

The framework of health promotion programmes in schools to support the overall development of students has been around for a few decades. It is based on the idea that good health education practices involve collective and coordinated efforts of parents, teachers and school administration in addressing students' health issues through counselling, discussion and dialogues, moral coaching, appreciation of positive behaviours etc. Elementary students lack proper awareness regarding food, nutrition, hygiene and treatment required for health conditions. In addition to this, Covid pandemic has given a push in taking health promotion policies and actions of schools very seriously. In order to ensure the healthy development of children, the active engagement of primary school teachers in the health matters of children is a prerequisite. Along with parents, teachers are the people with children who spend most of their time. As teachers are getting ample time to observe, interact, analyse and evaluate the performance of students, the role expectations for primary school teachers in contemporary society also change. The primary school teachers are expected to go through an intra-role transition by improving their general and childhood stage-related health awareness, act as a health monitor, being a health trainer for the children and function as a public health worker who can identify general trends of health issues in children and contribute to policy-making. The successful role transition of primary school teachers will depend on many factors. Appropriate time should be given to the teachers to readjust; there should be a clearly defined space which contains health resources and health service support on which primary school teachers can work and a vested authority which gives transparency to which extent teachers can interfere in health-related matters of children. There is no question regarding the importance of role of primary school teachers in the healthy development of children. They can contribute at an immense level to ensure the overall development of children. This makes primary school teachers an indispensable stakeholder in the health-promoting actions of schools. But it is also relevant to understand that teachers are not medical experts or that not every teacher



**Jogy George and Suresh Babu**

has the internal motivation to be part of the health promotion of students. So the role expectations on primary school teachers to intervene in student health matters should not be over-exaggerated.

**Disclosure of Interest**

The authors report that there are no competing interests to declare.

**REFERENCE**

1. Al-Amari, H. (2007). An evaluation of the role of elementary school teachers in Kuwait in promoting health. *International Journal of Health Promotion and Education*, 45(4), 121–124. <https://doi.org/10.1080/14635240.2007.10708117>
2. Banerjee, J., & Kiran, P. (2022). Post pandemic school reluctance – do children require attention, support, and intervention? *Asian Journal of Psychiatry*, 67, 102940. <https://doi.org/10.1016/j.ajp.2021.102940>
3. Biddle, B. J. (1986). Recent developments in role theory. *Annual Review of Sociology*, 12(1), 67–92. <https://doi.org/10.1146/annurev.so.12.080186.000435>
4. Blake, V. (2020). Successful mentoring in action. *Mentoring Teachers in the Primary School*, 30–42. <https://doi.org/10.4324/9780429424199-5>
5. Brault, M. C., & Degroote, E. (2021). Caring, control, and accountability: Reasons behind teachers' participation in the medicalization of ADHD-related behaviors. In *Annual Meeting of the American Educational Research Association*.
6. Brivio, F., Fagnani, L., Pezzoli, S., Fontana, I., Biffi, L., Mazzaferro, A. D., Velasco, V., & Greco, A. (2021). School health promotion at the time of covid-19: An exploratory investigation with school leaders and teachers. *European Journal of Investigation in Health, Psychology and Education*, 11(4), 1181–1204. <https://doi.org/10.3390/ejihpe11040087>
7. Campbell, P. (2020). Rethinking professional collaboration and agency in a post-pandemic era. *Journal of Professional Capital and Community*, 5(3/4), 337–341. <https://doi.org/10.1108/jpcc-06-2020-0033>
8. Charner-Laird, M. (2022). The role of agency: Teachers, administrators, and caregivers navigate the COVID-19 pandemic. *Proceedings of the 2022 AERA Annual Meeting*. <https://doi.org/10.3102/1892591>
9. Chavan, G. M., & Chavan, V. M. (2018). Knowledge, attitude and practices of secondary school teachers regarding school health services in children. *International Journal Of Community Medicine And Public Health*, 5(4), 1541. <https://doi.org/10.18203/2394-6040.ijcmph20181232>
10. Ferindistika Putri, A., Andringrum, H., Khusnul Rofiah, S., & Gunawan, I. (2019). Teacher function in class: A literature review. *Proceedings of the 5th International Conference on Education and Technology (ICET 2019)*. <https://doi.org/10.2991/icet-19.2019.2>
11. Gant Bradley, H. (2014). Teachers creating safe school environments. <https://doi.org/10.33015 /dominic an.edu/2014.edu.04>
12. Hollander, K. (2021). Educating for a Recovering World: Developing Trauma-Sensitive Teaching Models in Response to COVID-19.
13. Hu, H., Wu, T., Fan, L., Zuo, K., Chen, L., Zhang, J., & Zhao, X. (2020). knowledge of child health and affecting factors among preschool teachers: A cross-sectional study in Chongqing, china. *Risk Management and Healthcare Policy*, Volume 13, 2515–2524. <https://doi.org/10.2147/rmhp.s280214>
14. Husain, I., Alamgir, M. A., & Shahzad, M. (2015). A study of health education and its needs for elementary school students. *i-Manager's Journal on School Educational Technology*, 10(3), 26–37. <https://doi.org/10.26634/jsch.10.3.3128>
15. Hwang, H. I., & Chae, H. K. (2018). Exploring the character strength of early childhood teachers. *Contemporary Social Sciences*, 27(1), 25–32. <https://doi.org/10.29070/27/57212>
16. Joshua, V. R. (2014). e. Oman-Towards a Healthy Society: A Case Study of e. Oman Initiative in Oman with Special Reference to ICT and Health. *Journal of Global Communication*, 7(1), 13-20.
17. Jourdan, D., Simar, C., Deasy, C., Carvalho, G. S., & Mannix McNamara, P. (2016). School Health Promotion and teacher professional identity. *Health Education*, 116(2), 106–122. <https://doi.org/10.1108/he-07-2014-0078>



**Jogy George and Suresh Babu**

18. Kamala Kumari, V. L. (2021). A study to assess the knowledge regarding the role of teachers in promoting healthy behavior in school children among primary school teachers in selected Primary Schools, Hyderabad, telangana. *International Journal of Research in Nursing*, 12(1), 49–52. <https://doi.org/10.3844/ijrnsp.2021.49.52>
19. Kumar, D. D., & Scuderi, P. (2000). Opportunities for teachers as policy makers. *Kappa Delta Pi Record*, 36(2), 61–64. <https://doi.org/10.1080/00228958.2000.10532019>
20. Lopes, J., Silva, E., Oliveira, C., Sass, D., & Martin, N. (2017). Teacher’s classroom management behavior and students’ classroom misbehavior: A study with 5th through 9th-grade students.
21. Louis, M. R. (1980). Career transitions: Varieties and commonalities. *Academy of Management Review*, 5(3), 329–340. <https://doi.org/10.5465/amr.1980.4288836>
22. Lowry, C., Leonard-Kane, R., Gibbs, B., Muller, L.-M., Peacock, A., & Jani, A. (2022). Teachers: The Forgotten Health Workforce. *Journal of the Royal Society of Medicine*, 115(4), 133–137. <https://doi.org/10.1177/014107682211085692>
23. Lowry, C., Stegeman, I., Rauch, F., & Jani, A. (2021). Modifying the school determinants of Children’s Health. *Journal of the Royal Society of Medicine*, 115(1), 16–21. <https://doi.org/10.1177/01410768211051718>
24. Ma, Z., Idris, S., Zhang, Y., Zewen, L., Wali, A., Ji, Y., Pan, Q., & Baloch, Z. (2021). The impact of covid-19 pandemic outbreak on education and Mental Health of Chinese children aged 7–15 years: An online survey. *BMC Pediatrics*, 21(1). <https://doi.org/10.1186/s12887-021-02550-1>
25. Mitic, W., Abdelaziz, B. F., & Madi, H. (2012). Health education: Theoretical concepts, effective strategies and core competencies. World Health Organization, Regional Office for the Eastern Mediterranean.
26. Nubani Husseini, M., Zwas, D. R., & Donchin, M. (2022). Teacher training and engagement in health promotion mediates health behavior outcomes. *International Journal of Environmental Research and Public Health*, 19(5), 3128. <https://doi.org/10.3390/ijerph19053128>
27. Núñez Díaz, C. (2020). Students’ mental health: The importance of the teacher’s role and training. *Revista Educación Las Américas*, 10(2), 277–287. <https://doi.org/10.35811/rea.v10i2.125>
28. Pietrabissa, G., & Simpson, S. G. (2020). Psychological consequences of social isolation during COVID-19 outbreak. *Frontiers in Psychology*, 11. <https://doi.org/10.3389/fpsyg.2020.02201>
29. Plakhotnik, M. S., Volkova, N. V., Jiang, C., Yahiaoui, D., Pheiffer, G., McKay, K., Newman, S., & Reißig-Thust, S. (2021). The perceived impact of COVID-19 on student well-being and the mediating role of the university support: Evidence from France, Germany, Russia, and the UK. *Frontiers in Psychology*, 12. <https://doi.org/10.3389/fpsyg.2021.642689>
30. Pokharel, S. D., & Adhikari, R. (2020). Teachers’ awareness toward students’ psychosocial wellbeing. *Dhaulagiri Journal of Sociology and Anthropology*, 14, 22–27. <https://doi.org/10.3126/dsaj.v14i0.29454>
31. Rodríguez-Triana, M. J., Prieto, L. P., Ley, T., de Jong, T., & Gillet, D. (2020). Social practices in teacher knowledge creation and innovation adoption: a large-scale study in an online instructional design community for inquiry learning. *International Journal of Computer-Supported Collaborative Learning*, 15(4), 445–467.
32. Sadaf, N., & Huma, A. (2021). Teachers’ knowledge regarding children’s health at the elementary school level. *Revija Za Elementarno Izobraževanje*, 14(1), 93–110. <https://doi.org/10.18690/rei.14.1.93-110.2021>
33. Saxena, R., Gupta, V., Rakheja, V., Dhiman, R., Bhardawaj, A., & Vashist, P. (2021). Lifestyle modification in school-going children before and after covid-19 lockdown. *Indian Journal of Ophthalmology*, 69(12), 3623. [https://doi.org/10.4103/ijo.ijo\\_2096\\_21](https://doi.org/10.4103/ijo.ijo_2096_21)
34. Singh, S., Roy, D., Sinha, K., Parveen, S., Sharma, G., & Joshi, G. (2020). Impact of covid-19 and Lockdown on Mental Health of Children and Adolescents: A Narrative Review with recommendations. *Psychiatry Research*, 293, 113429. <https://doi.org/10.1016/j.psychres.2020.113429>
35. Tilson, H., & Gebbie, K. M. (2004). The Public Health Workforce. *Annual Review of Public Health*, 25(1), 341–356. <https://doi.org/10.1146/annurev.publhealth.25.102802.124357>
36. Weeks, F. H. (2000). Behavior problems in the classroom: A model for teachers to assist learners with unmet emotional needs (thesis). Retrieved from <http://hdl.handle.net/10500/17854>
37. Zhou, J. (2021). The role of teacher-student relationships in the promotion of student wellbeing. *Learning & Education*, 10(3), 234. <https://doi.org/10.18282/l-e.v10i3.2468>





## Screening and Characterization of Bioflocculant Produced by *Pseudomonas aeruginosa* AJ4 for Treatment of Algal Polluted Water

Jayaprakash.A<sup>1\*</sup>, Revathy.S<sup>1</sup>, Vino.U<sup>2</sup> and Rajesh E.M<sup>3</sup>

<sup>1</sup>Ph.D Research Scholar, Department of Microbiology, PSG College of Arts & Science, (Affiliated to Bharathiar University) Coimbatore, Tamil Nadu, India.

<sup>2</sup>Ph.D Research Scholar, Department of Biochemistry, PSG College of Arts & Science, (Affiliated to Bharathiar University) Coimbatore, Tamil Nadu, India.

<sup>3</sup>Assistant Professor, Department of Microbiology, PSG College of Arts & Science, (Affiliated to Bharathiar University) Coimbatore, Tamil Nadu, India.

Received: 30 Jan 2024

Revised: 09 Feb 2024

Accepted: 26 Apr 2024

### \*Address for Correspondence

Jayaprakash.A

Ph.D Research Scholar,

Department of Microbiology,

PSG College of Arts & Science,

(Affiliated to Bharathiar University)

Coimbatore, Tamil Nadu, India.

Email: jayaprakashmicrobiologist501@gmail.com



This is an Open Access Journal / article distributed under the terms of the **Creative Commons Attribution License** (CC BY-NC-ND 3.0) which permits unrestricted use, distribution, and reproduction in any medium, provided the original work is properly cited. All rights reserved.

### ABSTRACT

This study explores the isolation and characterization of bioflocculant-producing strains from Kurichi Lake, Coimbatore, India, emphasizing their potential for water treatment. The latitude and longitude of the sampling site were 10°57'59.2"N 76°57'46.5"E. Locally sourced strains demonstrated cost-effective and region-specific advantages. Bacterial isolates, identified as *Pseudomonas aeruginosa*, exhibited distinctive characteristics through biochemical tests, gram staining, and colony morphology. Strain AJ4's 16S rRNA sequencing revealed a 99.9% resemblance to known *Pseudomonas* sp. strains (accession number OL818310). Under optimized conditions, *Pseudomonas aeruginosa* OL818310 produced a bioflocculant with a yield of 1.29 g/L, demonstrating efficient flocculation in kaolin clay suspension and algal-polluted water. Flocculating activity reached 94% for acidity and 92% for kaolin clay suspension. Microscopic analysis illustrated the efficacy of bioflocculant treatment in water purification. The bioflocculant also exhibited a remarkable 98% flocculating efficiency in algal-polluted water, influencing various water parameters. The bioflocculants are characterized by the use of FTIR, SEM, GC-MS, and TGA. This study contributes valuable insights into the sustainable and effective application of locally isolated strains for bioflocculant production, highlighting their role in addressing region-specific water quality challenges. The findings promote eco-friendly approaches in water treatment and pollution

74395





Jayaprakash *et al.*,

control, presenting a comprehensive understanding of the bioflocculant-producing bacteria and their applications.

**Keywords:** Bioflocculant, *Pseudomonas aeruginosa*, Water Treatment, Eco-Friendly, Algal-Polluted Water, Microbial Flocculation.

## INTRODUCTION

Algal blooms, characterized by the rapid proliferation of algae under favourable conditions of nutrients, hydrology, and climate, presented significant threats to water ecosystems. Harmful algal blooms (HABs), particularly those involving toxic algae, adversely impact water quality and aquatic life. These effects confined reduced water transparency, lowered oxygen levels, heightened concentrations of algal toxins, mortality among aquatic organisms, and concerns regarding the safety of drinking water (Karlson *et al.*, 2021). The prevalence of HABs increased globally, affecting 108 countries and regions, with algal toxins detected in most instances (Harke *et al.*, 2016). Diatom blooms, dinoflagellate blooms, and cyanobacteria blooms were notable due to their frequent occurrence, extended duration, and algal toxins (Chen *et al.*, 2018). Eutrophication and climate change were identified as significant contributors to the frequency and duration of HABs. The discharge of nitrogen and phosphorus-rich domestic and industrial sewage into water bodies hastened global water eutrophication. Simultaneously, climate change heightened the frequency and intensity of HABs over the past three decades, underscoring the global nature of this issue (Sha *et al.*, 2021). Addressing the challenges posed by algal blooms required effective methods for microalgae harvesting. Commonly used techniques, such as centrifugation, coagulation-flocculation, filtration, and flotation, often had drawbacks, including high energy consumption or biomass contamination. Using biological organisms such as bacteria, algae, and fungi as flocculating agents in bioflocculation emerged as a promising alternative due to economic efficiency, simplicity, and effectiveness (Nazari *et al.*, 2021). Traditional flocculants may be synthetic, organic, or naturally occurring, with synthetic variants presenting environmental hazards due to their non-degradability. Bioflocculants produced by microorganisms gained attention as they were nontoxic, harmless, and biologically degradable. These microbial flocculants, secondary metabolites with flocculating activity, consisted of polysaccharides, proteins, cellulose, and nucleic acids. Polysaccharides were identified as the primary active ingredient, making them suitable for various applications in wastewater treatment, heavy metal removal, drinking water purification, and food fermentation. However, challenges like high production costs, low yield, and uncertain ingredients hindered their widespread industrial application (Sivasankar *et al.*, 2020; Guo *et al.*, 2022). In the pursuit of expanding bioflocculant utilization, this study focused on investigating the bioflocculant-producing ability of *Pseudomonas aeruginosa*. The research aimed to optimize, purify, and characterize the produced bioflocculant. Furthermore, the study reported on the bioflocculant's efficacy in removing heavy metals commonly found in wastewater, offering valuable insights for potential industrial applications.

## MATERIALS AND METHODS

### Bacterial strain

Isolated flocculating-capable bacteria were derived from water samples collected from Kurichi Lake in Coimbatore, Tamil Nadu, India, with each 500 ml sample meticulously collected in sterile plastic bottles. Subsequently, these samples were promptly transported in an icebox to the Microbiology Laboratory at PSG College of Arts & Science, Coimbatore, Tamil Nadu. Within six hours of collection, a serial dilution was performed to identify bacterial strains, and a specific strain underwent primary gram stain and biochemical parameter assessments to elucidate its bacterial morphology. To further characterize the microorganism, 16S rRNA partial sequencing was used to identify the specific flocculating strain, which was subsequently submitted to GenBank.



Jayaprakash *et al.*,**Media and culture cultivation conditions**

The isolated strain was cultured on LB agar medium, and the culture was preserved in nutrient agar medium with deep inoculation for subsequent studies. Subsequently, the strain was inoculated into 100 ml LB broth medium in 250 ml flasks on a rotary shaker at 200 rpm for 24 hours. After incubation, 1% of the inoculum was transferred into a 250 ml fermentation medium in a 500 ml flask for 72 hours. The fermentation medium contained the following components per g/liter:  $(\text{NH}_4)_2\text{SO}_4$  0.5, yeast extract 5.0, glucose 5.0,  $\text{K}_2\text{HPO}_4$  10.0,  $\text{KH}_2\text{PO}_4$  5.0, and  $\text{MgSO}_4 \cdot 7\text{H}_2\text{O}$  0.30. The pH was adjusted to 7 using 1M HCl and 1M NaOH (Chen *et al.*, 2021). Following a 24-hour incubation, the culture broth was centrifuged at  $10,000 \times g$  for 30 minutes. The resulting cell-free supernatant was collected and utilized as a liquid bioflocculant. The flocculating activity of the liquid bioflocculant was subsequently analyzed using the Kuraneet *et al.* (1994) method.

**Optimization parameters on bioflocculant produced by *Pseudomonas aeruginosa***

The factors influencing the bioflocculant production by *Pseudomonas aeruginosa* OL818310 were assessed at a pH range of 3 to 12, temperature of 20, 25, 30, 35, 40, 45, 50°C, incubation time of 12, 24, 36, 48, 60, 72, 96, 108, 120 hours, carbon sources of glucose, maltose, sucrose, lactose, fructose, starch, guar gum, nitrogen sources of urea, yeast extract, ammonia, peptone, casein, agitation rate of 0, 55, 110, 165, 220 rpm and inoculum concentration ranging 1 to 4% (Salehizadeh & Yan, 2014).

**Extraction and purification of bioflocculant**

The purification process followed the method Agunbiade *et al.* (2018) outlined. After 72 hours of fermentation, the culture broth underwent centrifugation at  $8000 \times g$  for 30 minutes to eliminate bacterial cells. The sterile distilled water was added to the supernatant phase, and another round of centrifugation at  $8000 \times g$  for 15 minutes was carried out to remove insoluble substances. Ethanol was introduced in two volumes to the supernatant, stirred, and allowed to stand for 12 hours at four °C. The resulting residue was vacuum-dried, producing the crude bioflocculant. This crude product was dissolved in water to form a solution. One volume of a mixed solution of chloroform and n-butyl alcohol (5:2, v/v) was added to the solution. The mixture was stirred by pouring into a separating funnel, which stood for 12 hours at room temperature. The cell-free supernatant was discarded, and two volumes of ethanol ( $\text{C}_2\text{H}_5\text{OH}$ ) were added to retrieve the residue. The recovered residue was then subjected to lyophilization to obtain a purified bioflocculant.

**Characterization of purified bioflocculant**

The total protein content of the bioflocculant was determined by the Lowery method with BSA (Bovine Serum Albumin) as standard. The total sugar content of the bioflocculant was assessed using the phenol-sulfuric method with glucose as standard. The functional groups of the purified bioflocculant were analyzed in FTIR (Shimadzu, IR Affinity-1S Japan) with a range of  $400 - 4000 \text{ cm}^{-1}$  (Manivasagan *et al.*, 2015). The purified bioflocculant sample was subjected to SEM equipped with an elemental analyzer (Carl ZEISS EVO 18- Germany) to find the elements in the purified bioflocculant. The kaolin clay suspension was used as a control. The presence of volatile compounds in bioflocculant was analyzed by GCMS done at PSG Institute of Advanced Studies (PSGIAS), Coimbatore, Tamil Nadu, India (Ashwini Prabhakar *et al.*, 2020). The pyrolysis of the purified bioflocculant was evaluated using a TG-DSC analyzer (NETZSCH STA 449F3) with a temperature range of 26°C - 1200°C and a heating rate of 20°C/minute (Muthulakshmi *et al.*, 2017).

**Application in algal polluted pond water**

The pond water contaminated with algae was collected aseptically from Periyakulam in Coimbatore (Latitude: 10°59'11.0"N and Longitude: 76°57'21.3"E), Tamil Nadu, India. The collected water sample was transferred to the PSG College of Arts and Science, Department of Microbiology Laboratory, Coimbatore, Tamil Nadu, India. To 200 mL of water, 1.0 mg/mL of the purified bioflocculant was added and allowed for the flocculation process to occur. After bioflocculation, the supernatant was gently removed, and physiochemical parameters of BOD, COD, TSS and TDS were evaluated. The untreated sample served as control (Fraga-Garcia *et al.*, 2018).



Jayaprakash *et al.*,

### Statistics and Software

All the experiments were performed in triplicate. The mean and standard deviations were calculated using Origin 2023b software. All p values <0.05 were considered as significant.

## RESULTS AND DISCUSSION

### Sample Collection

In this study, biofloculant-producing strains were isolated from Kurichi Lake, Coimbatore, India, to develop effective and eco-friendly solutions for water treatment. The sampling area exhibited diverse microorganisms, suggesting a rich source of potential strains with biofloculant-producing capabilities (Fujita *et al.*, 2000). Strains isolated from water samples were particularly promising for aquatic environments, as they were likely to possess inherent traits conducive to thriving and biofloculant production under water treatment conditions (Agunbiade *et al.*, 2017). The latitude and longitude of the sampling site were 10°57'59.2"N 76°57'46.5"E. The unique characteristics of strains from Kurichi Lake made them well-suited for treating pollutants commonly found in the lake water (Figure 1). Moreover, utilizing locally isolated strains offered practical advantages, such as cost-effectiveness and eliminating the need for transportation from other sources. This research promoted the development of sustainable and efficient biofloculants tailored to the specific environmental conditions of Kurichi Lake, contributing to eco-friendly approaches in water treatment and pollution control. The findings underscored the potential of locally sourced biofloculant-producing strains for addressing water quality challenges in a region-specific context (Zhu *et al.*, 2017).

### Isolation and identification of biofloculant producing bacteria and their characteristics

Biofloculant-producing bacteria were successfully isolated and identified, and their corresponding characteristics are depicted in Figure 2. The distinctive colonies obtained through the spread plate technique, visually depicting the isolation process. The spread plate technique and colony morphology results are shown cohesively, illustrating the initial steps of the isolation process. Figure 2a further scrutinizes bacterial colony morphology, offering visual insights into the physical characteristics of the isolated strains. Gram staining results, shown in Figure 2b, reveal gram-negative, rod-shaped structures, adding precision to the characterization of the isolated biofloculant-producing strains. Additionally, to confirm the identity of the strains, biochemical tests specific to *Pseudomonas aeruginosa* were conducted (Figure 2c). The characteristic blue-green pigment, pyocyanin, associated with *Pseudomonas aeruginosa* colonies, is evident, contributing to their distinctive coloration. The metabolic traits of the isolated strains were elucidated through biochemical tests. Indole and MR tests yielded negative results, while VP was negative. The citrate test was positive, indicating citrate utilization. TSIA results revealed an alkali/alkali reaction (Red/Red), suggesting specific metabolic activities of the strains. Urease activity was negative, and glucose utilization was not observed. However, mannitol utilization was positive, contrasting with negative results for sucrose and lactose. Gelatin hydrolysis was positive, indicating enzymatic activity, while H<sub>2</sub>S production was negative. These detailed results, collectively presented in Figure 2, contribute to a comprehensive understanding of the isolated biofloculant-producing bacteria and their distinctive characteristics.

### 16S rRNA gene sequencing

Similarly, AJ4 strain was sequenced by 16S rRNA and submitted in BLAST to search the similar strains related to *Pseudomonase* sp. The 99.9% resemblance sequences that appeared relevant in BLAST were acquired from NCBI GenBank and aligned with the aid of the CLUSTALW software. The phylogenetic tree was constructed by using neighbour joining method with MEGA 11 software. The selected strain was submitted to NCBI GenBank and the accession number of OL818310 (Figure 3).



Jayaprakash *et al.*,**Optimization of *Pseudomonas aeruginosa* OL818310 for growth of culture and bioflocculant production****Effect of initial pH for the growth of *Pseudomonas aeruginosa* and bioflocculant production**

Microbial cells exhibit varying oxidation-reduction capacities, regulated by the initial pH levels that impact bioflocculant production and microbial growth biosynthesis (Suresh *et al.*, 2018). Figure 4 shows that flocculating activity consistently increases in the fermentation broth culture, ranging from 39.02% at pH 3 to 68.70% at pH 7, followed by a gradual decline to 28.90% at pH 12. The optimal pH for bioflocculant production is within the neutral range of  $7 \pm 0.2$ . Similar results were observed by Guo *et al.* (2018), who reported that bioflocculant produced by *Pseudomonas boreopolis* G22 showed the highest flocculating activity of 97.1% at pH 7.

**Effect of temperature on *Pseudomonas aeruginosa* cultivation and bioflocculant production**

The effect of temperature on bioflocculant production by *Pseudomonas aeruginosa* OL818310 was evaluated (Figure 5). When the temperature was adjusted to 35°C, the flocculating activity of the bioflocculant was achieved to a maximum flocculating activity of 92.38%, which was the optimum temperature. The flocculating activity of the bioflocculant steadily decreased as the temperature exceeded 40°C. Microorganism metabolism is proportional to temperature, and maximum enzymatic activation is attained at optimized temperatures. The cultivation temperature affects the synthesis of bioflocculant and microbial metabolism (Xia *et al.*, 2022).

**Effect of inoculum size for *Pseudomonas aeruginosa* growth and bioflocculant production**

The effect of inoculum size was significant for the bioflocculant production from *Pseudomonas aeruginosa* OL818310 (Figure 6). Therefore, different inoculum size ranges of 1% to 5% were used to measure the flocculation activity. Flocculation efficiency was observed in 41.95%, 50.58%, 62.31, 66.13% and 48.62%, respectively. Correspondingly, the highest flocculating activity of 66.13% was observed in 4% of the inoculum size. Therefore, a large inoculum size prolongs the stationary phase during bioflocculant production, while small inoculum sizes inhibit bioflocculant production with a significant overlap (Ntsangani *et al.*, 2017).

**Effect of carbon as an energy source for *Pseudomonas aeruginosa* growth and bioflocculant production**

The effect of carbon sources is essential for culture cultivation and bioflocculant production synthesis (Jang *et al.*, 2001). For *Pseudomonas aeruginosa* OL818310, the impact of different carbon sources was evaluated in Figure 7. The maximum flocculation activity (92.65%) was achieved using guar gum as a carbon source for culture cultivation and bioflocculant production. According to Dwari & Mishra (2019), the guar gum as a green flocculant was used to investigate flocculation sedimentation uses to remove the turbidity at 83% in pH 5 using 200g/tonne of solid.

**Effect of nitrogen as an energy source for *Pseudomonas aeruginosa* growth and bioflocculant production**

Another important source for bioflocculant production is nitrogen, shown in Figure 8. The organic nitrogen source of peptone shows the highest flocculating activity of 85.65% observed compared to other nitrogen sources. Different nitrogen sources of yeast extract (74.29%), urea (59.12%), tryptone (55.15%) and ammonium (42.59%) show the lowest flocculating activity. Similar results were observed in Nwodo *et al.* (2013), who reported that 1.5 g/L of peptone is a nitrogen source for bioflocculant production, enhancing the flocculation activity of 98.9%.

**Effect of cation for *Pseudomonas aeruginosa* growth and bioflocculant production**

The effect of different cations in bio flocculant production, such as Li<sup>+</sup>, Na<sup>+</sup>, Mn<sup>2+</sup> K<sup>+</sup>, Ca<sup>2+</sup>, Al<sup>3+</sup>, and Ba<sup>2+</sup>, was observed (Figure 9). The highest flocculating efficacy of 95.08% was observed in Ca<sup>2+</sup>. The other cations show 80.10%, 78.60%, 54.28%, 63.16%, 72.4% and 69.91% flocculation activity, respectively.

**Effect of shaking speed for *Pseudomonas aeruginosa* growth and bioflocculant production**

The influence of shaking speed on bioflocculant production by *Pseudomonas aeruginosa* OL818310 was evaluated (Figure 10). The maximum shaking speed was determined as 220 rpm, and the maximum flocculating activity was 92.86%. The shaking speed determines dissolved oxygen content, affecting nutrient absorption and enzymatic reaction. During the early growth phase, biomass and bioflocculant production were lower, resulting in lower viscosity of culture broth and oxygen demand Li *et al.*, 2016. Beyond this, the bioflocculant activity was reduced due



**Jayaprakash et al.,**

to the high shear stress that negatively impacts cell growth and bioflocculant production, as reported by Maliehet al., 2019.

**Production, extraction and purification of bioflocculant**

The bioflocculant was produced by *Pseudomonas aeruginosa* OL818310 under optimized conditions: 1% guar gum as carbon source, 1% peptone as nitrogen source, pH of 7, temperature of 35°C, 1% Ca<sup>2+</sup> of cations, shaking speed of 220 rpm, inoculums concentration of 4% and time course assay illustrated in Figure 11. The strain, *Pseudomonas aeruginosa* OL818310, has a bioflocculant yield of 1.29 g/L of bioflocculant produced. There was no cell growth was observed in the lag phase of 24 hours. It indicated that the bioflocculant production happened during cell growth, not cell autolysis. The maximum flocculating acidity of 94% was achieved at 72 hours, demonstrating that maximum bioflocculant production occurred during the late exponential stage and early stationary growth phase (Guo et al., 2018). There were decreases in flocculating activity from 84 hours, and this may have been due to the cell autolysis in the enzyme activity during the death phase (Saha et al., 2021). The optical density has started to decrease from 84 – 96 hours, and this decline may have been due to the clarification of dead cell debris in the medium. The pH declined steadily from 0 to 120 hours. The decrease in pH may have been due to the production of organic acids during metabolism or as bioflocculant components (Natarajan, 2015).

**Determination of the bioflocculation activity of the *Pseudomonas aeruginosa* AJ4 OL818310 produced bioflocculant against kaolin clay suspension**

The flocculating activity was determined against kaolin clay suspension described by Kurane et al. (1994). The purified bioflocculant was mixed with kaolin clay suspension to reach the maximum % flocculating rate of 92%. Figure 12 illustrates the microscopic images of kaolin clay suspension before and after being treated with the bioflocculant. The kaolin clay was distributed uniformly in the liquid medium before adding the bioflocculant, and the kaolin clay found no flocculation (figure 12 a). When the bioflocculant treated kaolin clay seems small, floc formation occurs after 5 minutes of settling time (figure 12 b). Similar results reported by Li et al., 2018 observed that settling time increased the volume of floc size will be increased. When the flocculation time reaches 5 min, the floc formation will be increased to the maximum level. The mechanism of kaolin flocculation occurred by a bioflocculant that neutralized the kaolin clay through van der Waals force to promote large floc (Salim et al., 2011).

**Characterizations of purified bioflocculant produced by *Pseudomonas aeruginosa* AJ4 OL818310****FTIR**

The FTIR analysis of purified bioflocculant revealed O-H stretching observed at 3344.92 cm<sup>-1</sup>, indicating N-H stretching aliphatic primary amine, C=C stretching alkene at 1639.49 cm<sup>-1</sup>. C-H bending monosubstituted at 731.02 cm<sup>-1</sup> and 597.93 cm<sup>-1</sup> indicated a halo compound (Figure 13). The FTIR spectrum evidenced that the purified bioflocculant was known to contain polysaccharides with hydroxyl and alkyne groups as an active functional group. All these results are well in accordance with the research done earlier by Ntozonkeet al., (2017), who stated the presence of the hydroxyl group as an active functional group of the bioflocculant obtained in *Pseudomonas aeruginosa* AJ4 OL818310.

**SEM**

The Scanning Electron Microscope analysis was performed to determine the morphology of bioflocculant obtained from *Pseudomonas aeruginosa* AJ4 OL818310 against kaolin clay powder standard. The purified bioflocculant by the active strain *Pseudomonas aeruginosa* AJ4 OL818310 was found to be amorphous, whereas fine scattered uniform kaolin clay particles were observed (Figure 14). These SEM results were well correlated with the results of Okaiyeto et al., 2015 and Tlou, (2017).

**Gas Chromatography-Mass Spectrometry (GC-MS)**

The volatile compounds of purified bioflocculant were analyzed with GC-MS analysis (Figure 15) (Table 1). A total of 21 compounds were identified through peak values and retention time. The Norcinnamolaurine compound has a high peak value obtained at 34.87% and a retention time of 19.929/min. The second high peak value of 11.47% and



**Jayaprakash et al.,**

retention time of 6.153/min was observed as a 1,1,3-Triethoxypropane compound with 100% probability. The third high peak value of 10.26% indicates the presence of Dibutyl phthalate compound in 15.819/min retention time. Corresponding results were observed from Pathak *et al.* (2017), who characterized *n*-hexadecane utilizing a novel bioflocculant-producing bacterium of *Pseudomonas aeruginosa* IASST201 strain applied for heavy metals removal.

**Thermogravimetric analysis (TGA)**

Thermogravimetric analysis was used to measure the thermal stability of the purified bioflocculant obtained from *Pseudomonas aeruginosa* AJ4 OL818310. Differential scanning calorimetry (DSC) was also used to measure the changes in the physical properties at different temperatures. The Result illustrated in Figure 16 indicated that an initial weight loss of 13.65% was observed at a temperature of 100°C. This was followed by 2.80% of the weight loss that occurred above 500°C, and 1.40% of the weight loss was observed over 1000°C. Based on the results, *Pseudomonas aeruginosa* AJ4 OL818310 could be attributed to the dissociation of the structure of polysaccharides, predicting that the bioflocculant was highly thermostable, which confers industrial usage. Similar results were observed by who Ngema *et al.* (2020), who reported bioflocculant produced from *Bacillus pumilus* JX860616 shown more thermal stability in 1000°C.

**Algal polluted pond water treatment**

The algal polluted water was collected and cultivated in the algal Laboratory, Department of Microbiology, PSG College of Arts & Science, Coimbatore, Tamil Nadu, India (Figure 17). After algal cultivation, 1 g of purified bioflocculant was added and measured the water parameters such as, colour, odour, TSS (Total suspended solids), TDS (Total dissolved solids), pH, temperature, turbidity, BOD, COD, alkalinity, hardness, calcium, magnesium, sodium carbonate, chloride, chlorine, nitrate nitrogen, fluoride, Faecal coliform and *E.coli* (Table 2). The flocculating activity of algal polluted water was measured based on Fraga-Garcia *et al.* (2018). In that 98% of the flocculating efficiency was observed during algal flocculation. Similar research study was reported by Ndikubwimana *et al.* (2016), using *Bacillus licheniformis* CGMCC 2876 to treat freshwater microalgae *Desmodesmus brasiliensis* at 98% flocculating activity.

**CONCLUSION**

The water sample was collected from the Kurichi Lake in Coimbatore, Tamil Nadu, India and isolated bioflocculant producing strain named as AJ4. The AJ4 strain was identified using 16S rRNA sequencing to know 99% similarity with *Pseudomonas aeruginosa* and the strain was submitted in the National Center for Biotechnology Information (NCBI) GenBank accession number of OL818310. Then the strain was optimized to cultivated in batch fermentation to produce the bioflocculant in a stationary phase of the bacterial growth. The characterization studies were carried to find the functional groups, morphology, functional compounds and thermal stability. In this study, bioflocculant AJ4 flocculates the algae in the water at 98% to remove and correspondingly reduces the BOD, COD levels. Here, 1% of guar gum and peptone used as nutrient source help for bacterial growth and achieve 86.5% of flocculation activity. The presence of 21 volatile compounds and functional groups in the bioflocculant was observed by GCMS and FTIR analysis. The thermal stability of the bioflocculant and flocculating ability in higher temperature were also measured. Based on these findings, bioflocculant can flocculate in any polluted environment and is suitable for multiple industrial purposes. The algal polluted Periyakulam water samples were tested and the results showed flocculating values of TSS (Total suspended solids), TDS (Total dissolved solids), pH, temperature, turbidity, BOD, COD, alkalinity, hardness, calcium, magnesium, sodium carbonate, chloride, chlorine, nitrate nitrogen, fluoride, Faecal coliform and *E.coli*. After flocculating treatment, TSS (Total suspended solids), TDS (Total dissolved solids), pH, temperature, turbidity, BOD, COD, alkalinity, hardness, calcium, magnesium, sodium carbonate, chloride, chlorine, nitrate nitrogen, fluoride, Faecal coliform and *E.coli* were reduced enormously and tests of COD, TDS results showed moderately reduced. Due to its bioflocculant potential, it can be used in the treatment of polluted water and wastewater.





Jayaprakash et al.,

## ACKNOWLEDGEMENTS

Authors acknowledge Tamil Nadu State Council for Science and Technology (TNSCST) for financial assistance under RFRS (Research Funding for Research Scholars / TNSCST/RFRS/VR/05/2019-20), Chennai. We also thank Department of Science Technology (DST), New Delhi for their infrastructure assistance under FIST (Fund for Improvement of S&T Infrastructure) scheme.

### Statements

The authors have declared that they have no conflict of interest in the publication.

### Authors Contribution

All authors contributed to the study conception and design. Material preparation, data collection and analysis were performed by Jayaprakash. A, Revathy. S and Rajesh E. M. The first draft of the manuscript was written by Jayaprakash. A and all authors commented on previous versions of the manuscript. All authors read and approved the final manuscript.

### Declarations

#### Ethical Approval

The ethical approval declaration was not applicable for this manuscript

### Funding

Tamil Nadu State Council for Science and Technology (TNSCST) under RFRS (Research Funding for Research Scholars / TNSCST/RFRS/VR/05/2019-20), Chennai.

### Data Availability

No dataset available

## REFERENCES

1. Karlson, B., Andersen, P., Arneborg, L., Cembella, A., Eikrem, W., John, U., ... & Suikkanen, S. (2021). Harmful algal blooms and their effects in coastal seas of Northern Europe. *Harmful Algae*, 102, 101989.
2. Harke, M. J., Steffen, M. M., Gobler, C. J., Otten, T. G., Wilhelm, S. W., Wood, S. A., & Paerl, H. W. (2016). A review of the global ecology, genomics, and biogeography of the toxic cyanobacterium, *Microcystis* spp. *Harmful algae*, 54, 4-20.
3. Chen, J., Leng, L., Ye, C., Lu, Q., Addy, M., Wang, J., ... & Zhou, W. (2018). A comparative study between fungal pellet-and spore-assisted microalgae harvesting methods for algae bioflocculation. *Bioresource technology*, 259, 181-190.
4. Sha, J., Xiong, H., Li, C., Lu, Z., Zhang, J., Zhong, H., ... & Yan, B. (2021). Harmful algal blooms and their eco-environmental indication. *Chemosphere*, 274, 129912.
5. Nazari, M. T., Rigueto, C. V. T., Rempel, A., & Colla, L. M. (2021). Harvesting of *Spirulina platensis* using an eco-friendly fungal bioflocculant produced from agro-industrial by-products. *Bioresource technology*, 322, 124525.
6. Sivasankar, P., Poongodi, S., Lobo, A. O., & Pugazhendhi, A. (2020). Characterization of a novel polymeric bioflocculant from marine actinobacterium *Streptomyces* sp. and its application in recovery of microalgae. *International Biodeterioration & Biodegradation*, 148, 104883.
7. Guo, H., Fu, X., Chen, Y., Feng, J., Qi, Z., Yan, M., ... & Shao, Q. (2022). Production of polysaccharide bioflocculants and gene co-expression network analysis in a biomass-degrading bacterium, *Pseudomonas* sp. GO2. *Renewable Energy*, 188, 997-1007.





## Jayaprakash et al.,

8. Kurane, R., Hatamochi, K., Kakuno, T., Kiyohara, M., Hirano, M., & Taniguchi, Y. (1994). Production of a bioflocculant by *Rhodococcuserythropolis* S-1 grown on alcohols. *Bioscience, biotechnology, and biochemistry*, 58(2), 428-429.
9. Salim, S., Bosma, R., Vermuë, M. H., & Wijffels, R. H. (2011). Harvesting of microalgae by bio-flocculation. *Journal of applied phycology*, 23, 849-855.
10. Ntozonke, N., Okaiyeto, K., Okoli, A. S., Olaniran, A. O., Nwodo, U. U., & Okoh, A. I. (2017). A marine bacterium, *Bacillus* sp. isolated from the sediment samples of Algoa Bay in South Africa Produces a Polysaccharide-Bioflocculant. *International journal of environmental research and public health*, 14(10), 1149.
11. Tlou, N. S. (2017). *Characterization of selected microbial species for bioflocculant producing potential and comparison with traditional flocculants in industrial waste water treatment* (Doctoral dissertation, University of Zululand).
12. Salehizadeh, H., & Yan, N. (2014). Recent advances in extracellular biopolymer flocculants. *Biotechnology Advances*, 32(8), 1506-1522.
13. Agunbiade, M., Pohl, C., & Ashafa, O. (2018). Bioflocculant production from *Streptomyces platensis* and its potential for river and waste water treatment. *Brazilian journal of microbiology*, 49, 731-741.
14. Manivasagan, P., Kang, K. H., Kim, D. G., & Kim, S. K. (2015). Production of polysaccharide-based bioflocculant for the synthesis of silver nanoparticles by *Streptomyces* sp. *International journal of biological macromolecules*, 77, 159-167.
15. Ashwini Prabhakar, S., Ojha, N., & Das, N. (2020). Application of Aloe vera mucilage as bioflocculant for the treatment of textile wastewater: process optimization. *Water Science and Technology*, 82(11), 2446-2459.
16. Muthulakshmi, L., Nellaiah, H., Kathiresan, T., Rajini, N., & Christopher, F. (2017). Identification and production of bioflocculants by *Enterobacter* sp. and *Bacillus* sp. and their characterization studies. *Preparative Biochemistry and Biotechnology*, 47(5), 458-467.
17. Fraga-García, P., Kubbutat, P., Brammen, M., Schwaminger, S., & Berensmeier, S. (2018). Bare iron oxide nanoparticles for magnetic harvesting of microalgae: from interaction behavior to process realization. *Nanomaterials*, 8(5), 292.
18. Agunbiade, M. O., Van Heerden, E., Pohl, C. H., & Ashafa, A. T. (2017). Flocculating performance of a bioflocculant produced by *Arthrobacter humicola* in sewage waste water treatment. *BMC biotechnology*, 17(1), 1-9.
19. Fujita, M., Ike, M., Tachibana, S., Kitada, G., Kim, S. M., & Inoue, Z. (2000). Characterization of a bioflocculant produced by *Citrobacter* sp. TKF04 from acetic and propionic acids. *Journal of Bioscience and Bioengineering*, 89(1), 40-46.
20. Zhu, L., Nugroho, Y. K., Shakeel, S. R., Li, Z., Martinkauppi, B., & Hiltunen, E. (2017). Using microalgae to produce liquid transportation biodiesel: what is next?. *Renewable and Sustainable Energy Reviews*, 78, 391-400.
21. Saha, S., Shukla, S. K., Singh, H. R., Pradhan, K. K., & Jha, S. K. (2021). Production and purification of bioflocculants from newly isolated bacterial species: a comparative decolourization study of cationic and anionic textile dyes. *Environmental Technology*, 42(23), 3663-3674.
22. Natarajan, K. A. (2015). Production and characterization of bioflocculants for mineral processing applications. *International Journal of Mineral Processing*, 137, 15-25.
23. Guo, H., Hong, C., Zhang, C., Zheng, B., Jiang, D., & Qin, W. (2018). Bioflocculants' production from a cellulase-free xylanase-producing *Pseudomonas boreopolis* G22 by degrading biomass and its application in cost-effective harvest of microalgae. *Bioresource technology*, 255, 171-179.
24. Xia, M., Zhou, H., Amanze, C., Hu, L., Shen, L., Yu, R., ... & Zeng, W. (2022). A novel polysaccharides-based bioflocculant produced by *Bacillus subtilis* ZHX3 and its application in the treatment of multiple pollutants. *Chemosphere*, 289, 133185.
25. Okaiyeto, K., Nwodo, U. U., Mabinya, L. V., Okoli, A. S., & Okoh, A. I. (2015). Characterization of a bioflocculant (MBF-UFH) produced by *Bacillus* sp. AEMREG7. *International Journal of Molecular Sciences*, 16(6), 12986-13003.
26. Pathak, M., Sarma, H. K., Bhattacharyya, K. G., Subudhi, S., Bisht, V., Lal, B., & Devi, A. (2017). Characterization of a novel polymeric bioflocculant produced from bacterial utilization of n-hexadecane and its application in removal of heavy metals. *Frontiers in microbiology*, 8, 170.







## Jayaprakash et al.,

27. Ntsangani, N., Okaiyeto, K., Uchechukwu, N. U., Olaniran, A. O., Mabinya, L. V., & Okoh, A. I. (2017). Bioflocculation potentials of a uronic acid-containing glycoprotein produced by *Bacillus* sp. AEMREG4 isolated from Tyhume River, South Africa. *3 Biotech*, 7, 1-12.
28. Jang, J. H., Ike, M., Kim, S. M., & Fujita, M. (2001). Production of a novel bioflocculant by fed-batch culture of *Citrobacter* sp. *Biotechnology letters*, 23, 593-597.
29. Ngema, S. S., Basson, A. K., & Maliehe, T. S. (2020). Synthesis, characterization and application of polyacrylamide grafted bioflocculant. *Physics and Chemistry of the Earth, Parts A/B/C*, 115, 102821.
30. Ndikubwimana, T., Zeng, X., Murwanashyaka, T., Manirafasha, E., He, N., Shao, W., & Lu, Y. (2016). Harvesting of freshwater microalgae with microbial bioflocculant: a pilot-scale study. *Biotechnology for biofuels*, 9(1), 1-11.
31. Dwari, R. K., & Mishra, B. K. (2019). Evaluation of flocculation characteristics of kaolinite dispersion system using guar gum: a green flocculant. *International Journal of Mining Science and Technology*, 29(5), 745-755.
32. Nwodo, U. U., & Okoh, A. I. (2013). Characterization and flocculation properties of biopolymeric flocculant (glycosaminoglycan) produced by *Cellulomonas* sp. Okoh. *Journal of applied microbiology*, 114(5), 1325-1337.
33. Li, Y., Jin, Y., Li, J., Li, H., & Yu, Z. (2016). Effects of thermal pretreatment on the biomethane yield and hydrolysis rate of kitchen waste. *Applied energy*, 172, 47-58.
34. Maliehe, T. S., Basson, A. K., & Dlamini, N. G. (2019). Removal of pollutants in mine wastewater by a non-cytotoxic polymeric bioflocculant from *Alcaligenes faecalis* HCB2. *International journal of environmental research and public health*, 16(20), 4001.

Table 1. GC-MS components of the purified bioflocculant from *Pseudomonas aeruginosa* AJ4 OL818310.

Compounds Name	Retention time (min)	Molecular formula	Molecular weight	Peak (%)	Probability (%)
1,1,3-Triethoxypropane	6.153	C <sub>9</sub> H <sub>20</sub> O <sub>3</sub>	176.25	11.47	100%
Zinc diamyldithiocarbamate	7.886	C <sub>22</sub> H <sub>44</sub> N <sub>2</sub> S <sub>4</sub> Zn	530.2	1.37	80.69%
4-iodo-N-[(3-methylthiophen-2-yl)methyl]aniline	8.097	C <sub>12</sub> H <sub>12</sub> INS	329.20	0.60	80.41%
Nonylcyclohexane	8.564	C <sub>15</sub> H <sub>30</sub>	210.40	1.03	66.21%
2,4-Diamino-6,8-bis[3,4-dichlorophenyl]-5,6-dihydro-8H-thiapyrano[4',3'-4,5]thieno[2,3-d]pyrimidine	10.108	C <sub>21</sub> H <sub>14</sub> Cl <sub>4</sub> N <sub>4</sub> S <sub>2</sub>	528.3	10.08	95.33%
Cyclododecane	10.375	C <sub>12</sub> H <sub>24</sub>	168.32	3.57	87.95%
3,5,23-Trimethyloctatriacontane	10.464	C <sub>41</sub> H <sub>84</sub>	577.1	0.94	94.96%
Cyclohexanebutanoic acid, 2-methyl-3-oxo-, methyl ester	10.597	C <sub>12</sub> H <sub>20</sub> O <sub>3</sub>	212.28	0.73	76.32%
Dihydropseudo-3,5-solasodiene-3-oltriacetate	11.064	C <sub>33</sub> H <sub>49</sub> NO <sub>5</sub>	539.7	0.97	96.18%
Hexaethylphosphoramidate	11.641	C <sub>12</sub> H <sub>30</sub> N <sub>3</sub> OP	263.36	0.61	30.67%
7-Hexadecene	12.519	C <sub>16</sub> H <sub>32</sub>	224.42	9.31	54.37%
Isopropylcyclohexane	13.186	C <sub>9</sub> H <sub>18</sub>	126.24	0.51	76.27%
Tributyltin oxide	13.308	C <sub>24</sub> H <sub>54</sub> OSn <sub>2</sub>	596.1	0.98	50.96%
Fumaric acid, 2-chloropropyl tridecyl ester	14.386	C <sub>20</sub> H <sub>35</sub> ClO <sub>4</sub>	374.9	3.34	95.65%
6-Tridecanone	15.097	C <sub>13</sub> H <sub>26</sub> O	198.34	1.40	79.35%





Jayaprakash et al.,

1 Lidocaine	15.297	C <sub>27</sub> H <sub>42</sub> N <sub>4</sub> O <sub>2</sub>	454.6	9.79	5.89%
N-(2-Diethylamino-ethyl)-2-(4-methyl-piperazin-1-yl)-nicotinamide	15.419	C <sub>17</sub> H <sub>29</sub> N <sub>5</sub> O	319.4	1.66	26.76%
Dibutyl phthalate	15.819	C <sub>16</sub> H <sub>22</sub> O <sub>4</sub>	278.34	10.26	8.85%
Carbonic acid, hexadecyl 2,2,2-trichloroethyl ester	16.108	C <sub>19</sub> H <sub>35</sub> Cl <sub>3</sub> O <sub>3</sub>	417.8	2.42	82.10%
3,3,7,11-Tetramethyltricyclo[5.4.0.0(4,11)]undecan-1-ol	17.652	C <sub>15</sub> H <sub>26</sub> O	222.37	0.82	98.78%
Norcinnamolaurine	19.929	C <sub>17</sub> H <sub>17</sub> NO <sub>3</sub>	283.32	34.87	77.34%

Table 2. Before and after treatment of algal polluted water.

Water parameters	Before treatment	After treatment
Color (Hazen)	50	<5.0
Odour	Objectionable	Agreeable
TSS (mg/L)	164	85.6
TDS (mg/L)	4200	174.2
pH	9.11	7.5
Temperature	27.5	27.2
Turbidity NTU	185.4	4.9
BOD (mg/L)	64	4.20
COD (mg/L)	362	19.50
Total alkalinity CaCO <sub>3</sub> (mg/L)	160	65.7
Total hardness as CaCO <sub>3</sub> (mg/L)	650	192
Calcium (mg/L)	320	79.1
Magnesium (mg/L)	180	29.6
Residual sodium carbonate (mg/L)	3.16	1.5
Chloride (mg/L)	2812	248
Residual free chlorine (mg/L)	124	0.32
Nitrate nitrogen (mg/L)	200	46
Fluoride (mg/L)	4.42	0.198
Faecal coliform (MPN/100ml)	0	0
<i>E. coli</i> (Presence/absence)	0	0

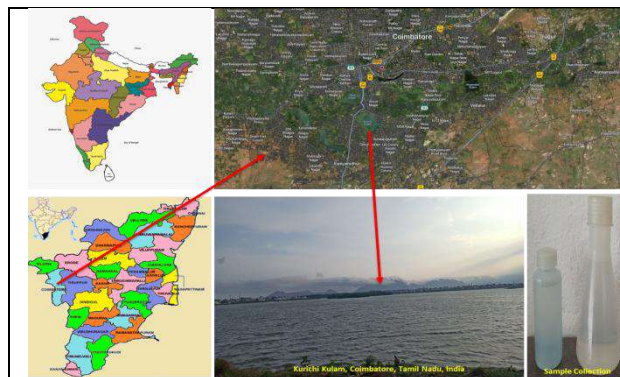


Figure 1. Sample collection area: Kurichikulam, Coimbatore, Tamil Nadu, India.

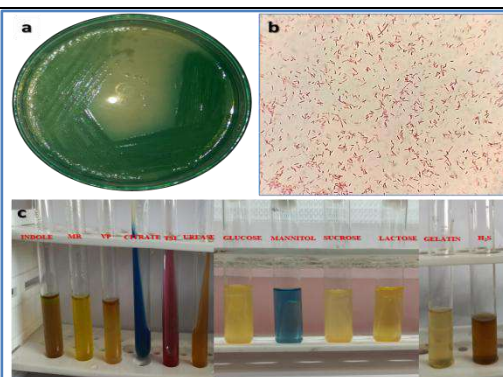


Figure 2. Isolation of biofloculant producing microorganism. a), isolated colonies b), gram's staining, c) biochemical results.





Jayaprakash et al.,

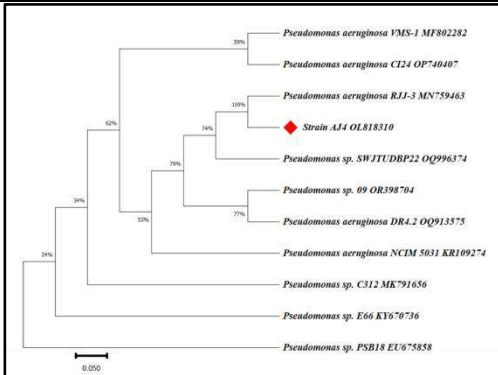


Figure 3. Phylogenetic tree construction of 16S rRNA sequenced bioflocculant producing bacteria *Pseudomonas aeruginosa* AJ4OL818310.

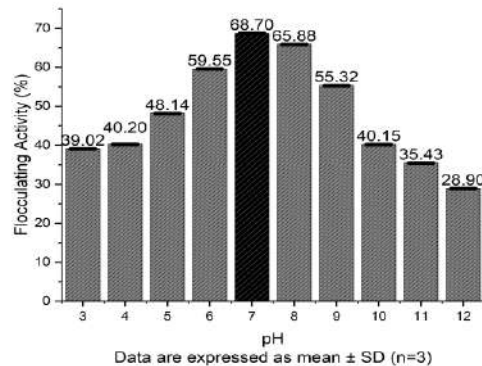


Figure 4. Initial pH of *Pseudomonas aeruginosa* OL818310 for bioflocculant production.

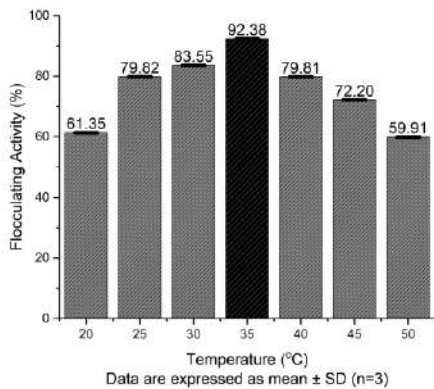


Figure 5. Effect of temperature on *Pseudomonas aeruginosa* OL818310 for bioflocculant production

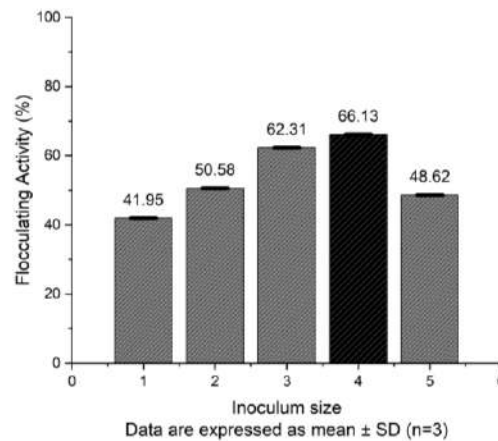


Figure 6. Inoculum size on *Pseudomonas aeruginosa* OL818310 for bioflocculant production.

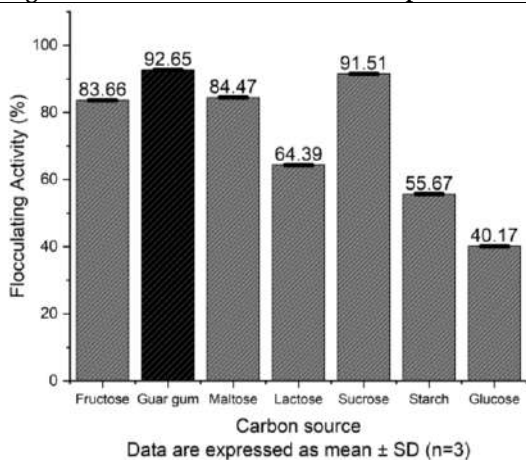


Figure 7. Carbon source on *Pseudomonas aeruginosa* OL818310 for bioflocculant production.

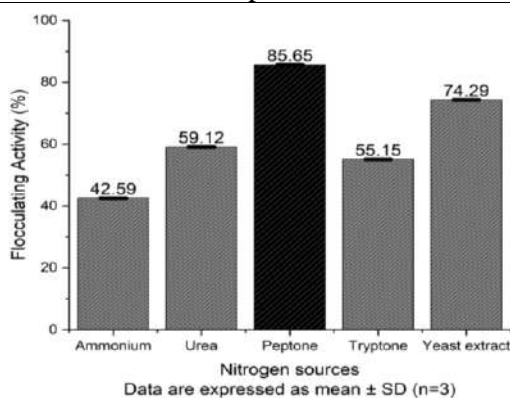


Figure 8. Nitrogen source on *Pseudomonas aeruginosa* OL818310 for bioflocculant production.





Jayaprakash et al.,

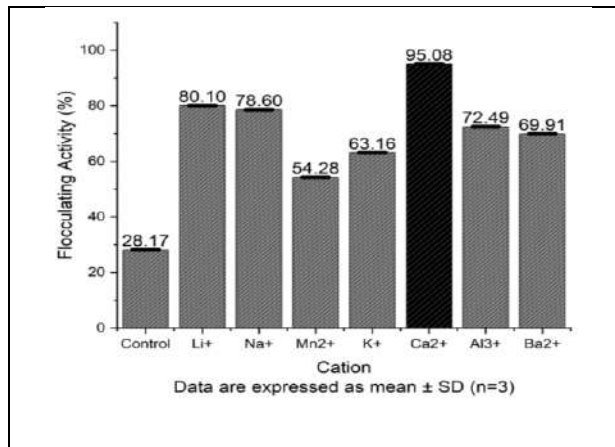


Figure 9. Cation on *Pseudomonas aeruginosa* OL818310 for bioflocculant production.

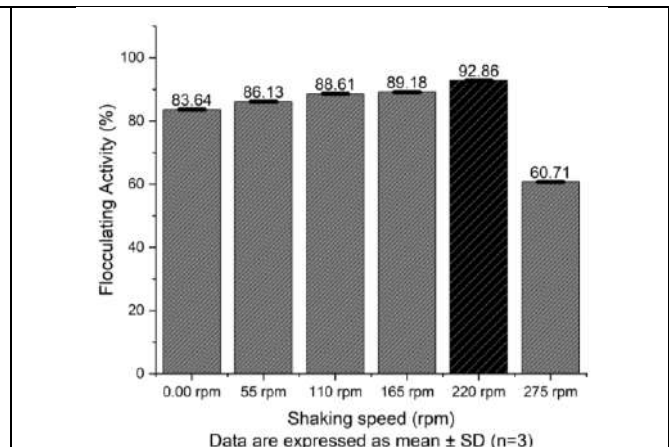


Figure 10. Shaking speed on *Pseudomonas aeruginosa* OL818310 for bioflocculant production.

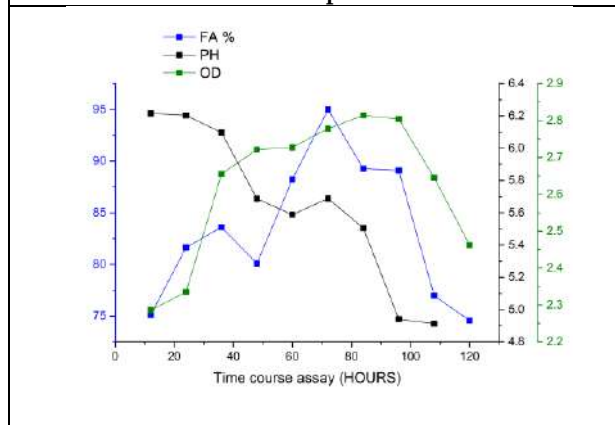


Figure 11. Time course assay for *Pseudomonas aeruginosa* on bioflocculant production.

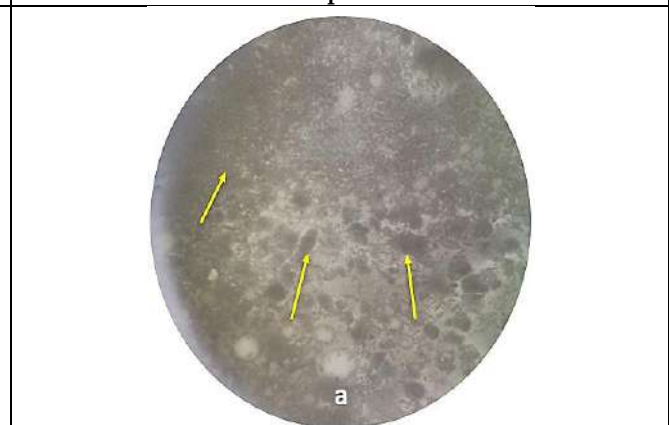


Figure 12. Microscopic picture of kaolin clay flocculated by purified bioflocculant a) Un-treated kaolin clay suspension

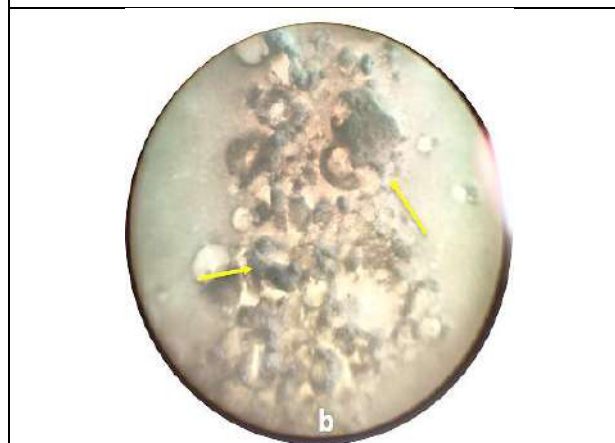


Figure 12b) bioflocculant treated kaolin clay suspension.

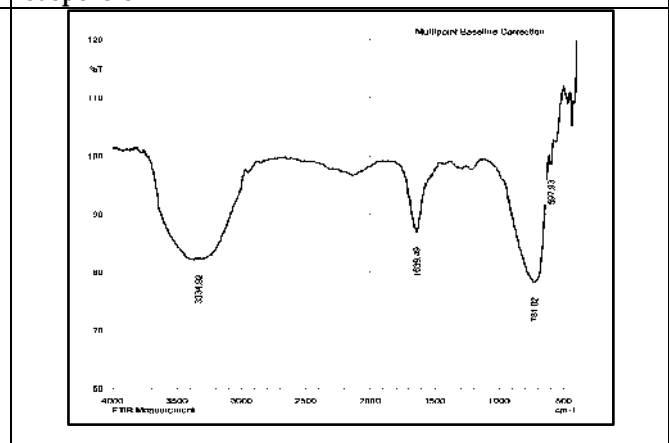


Figure 13. Fourier transform infrared spectrum of purified bioflocculant from *Pseudomonas aeruginosa* AJ4 OL818310.





Jayaprakash et al.,

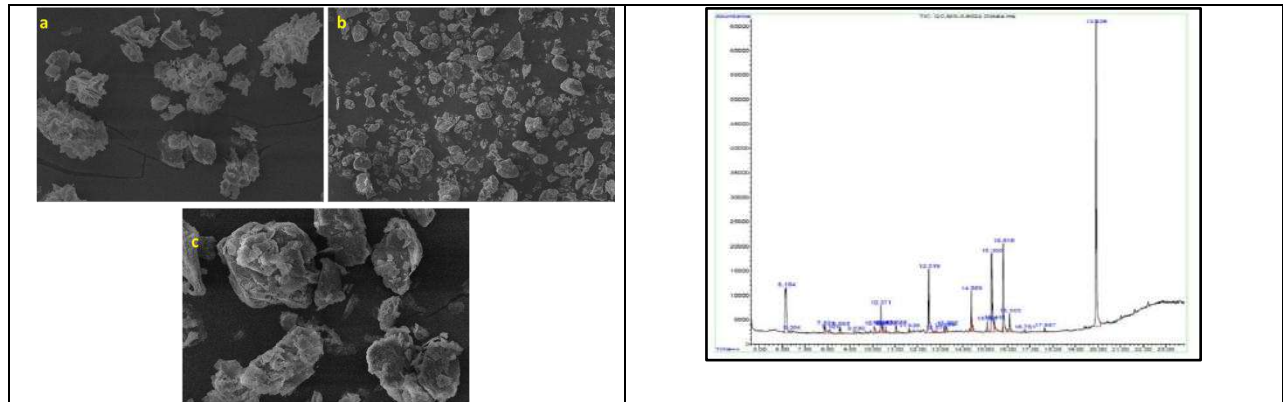


Figure 14. SEM images of (a) Purified biofloculant from *Pseudomonas aeruginosa* AJ4 OL818310 (b) Kaolin Clay particles (c) Kaolin clay particle flocculated by biofloculant AJ4.

Figure 15. Purified biofloculants from *Pseudomonas aeruginosa* AJ4 OL818310 of volatile compounds found by GC-MS.

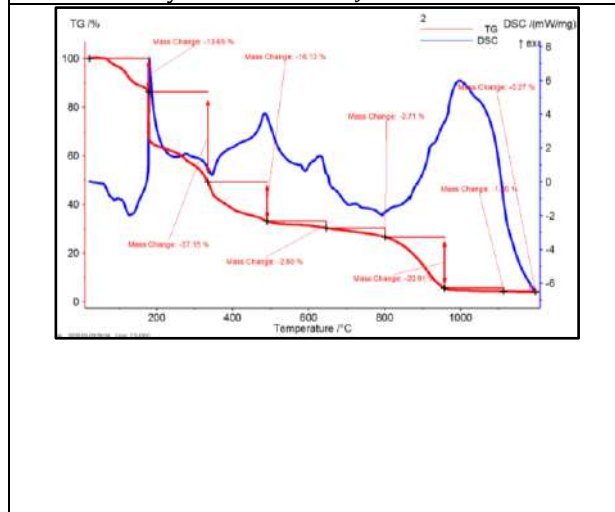


Figure 16. Thermogravimetric analysis purified biofloculant from *Pseudomonas aeruginosa* AJ4 OL818310.

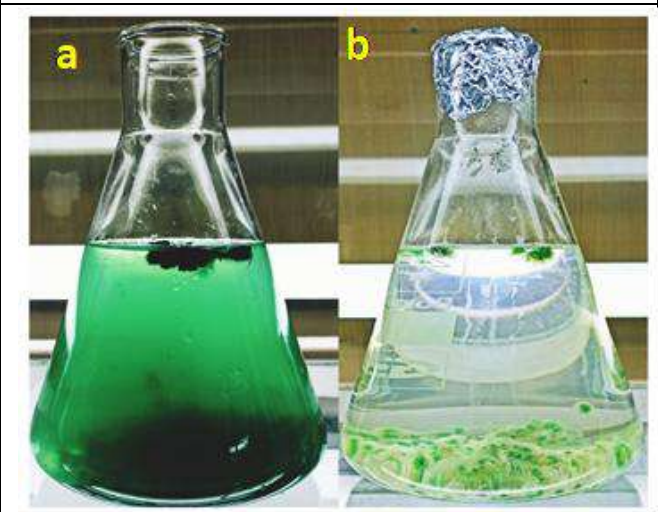


Figure 17. Algal polluted water (a) Before and (b) after treatment with purified biofloculant of *Pseudomonas aeruginosa* AJ4 OL818310.





## Phytochemical Screening and Antimicrobial Activity of *Melia azedarach* Leaf Extracts

Srinivas Reddy Annem\*

Associate Professor, Department of Zoology, Government Degree College, Warangal, (Affiliated to Kakatiya University) Telangana, India.

Received: 22 Jan 2024

Revised: 09 Feb 2024

Accepted: 27 Apr 2024

### \*Address for Correspondence

**Srinivas Reddy Annem**

Associate Professor,  
Department of Zoology,  
Government Degree College,  
Warangal, (Affiliated to Kakatiya University)  
Telangana, India.  
Email: annemreddys@gmail.com



This is an Open Access Journal / article distributed under the terms of the **Creative Commons Attribution License** (CC BY-NC-ND 3.0) which permits unrestricted use, distribution, and reproduction in any medium, provided the original work is properly cited. All rights reserved.

### ABSTRACT

The emergence and spread of antibiotic resistance, as well as the evolution of new strains of disease causing agents, are of great concern to the global health community. Effective treatment of a disease entails the development of new pharmaceuticals or some potential source of novel drugs. Commonly used medicinal plants of our community could be an excellent source of drugs to fight off this problem. Medicinal plants serve as an alternative source to synthetic drugs. Medicinal plants are gaining importance as they are less toxic, less expensive, safe in use and with less side effects. The phytochemical constituents of the medicinal plants can cure various human ailments. In this study, the plant *Melia azedarach* was selected and Phytochemical screening the antimicrobial activity of aqueous and methanol leaf extract of *Melia azedarach* was evaluated. The methanol and aqueous leaf extract of *Melia azedarach* was screened against 3 bacterial species viz., *Staphylococcus aureus*, *Pseudomonas aeruginosa*, *Escherichia coli* and one fungal species *Candida albicans*. The zones of inhibition were found to be between 7 mm to 13 mm at 50 mg/mL, 75 mg/mL, 100 mg/mL leaf extract concentrations. The result of the study revealed that the inhibition activity was dose dependent and the *Melia azedarach* methanol leaf extract showed maximum inhibitory activity compared to aqueous extract.

**Keywords:** Phytochemical screening, Antimicrobial activity, *Melia azedarach*, Inhibition zone, Disk diffusion method.



**Srinivas Reddy Annem****INTRODUCTION**

*Melia azedarach* belonging to Meliaceae family is a deciduous tree the leaves, Bark, and Fruits have a strong bitter flavor. The fully grown tree has a rounded crown, and commonly measures 7–12 meters (20–40 feet) tall, exceptionally 45 m (150 ft).[1] The leaves are up to 50 centimeters (20 inches) long, the leaflets are dark green above and lighter green below, with serrate margins. The flowers are small and fragrant, with five pale purple or lilac petals, growing in clusters. The fruit is a drupe, marble-sized, light yellow at maturity, hanging on the tree all winter, and gradually becoming wrinkled and almost white. The phytochemical screening of dried powdered leaves of *Melia azedarach* leaf extracts (Ethyl acetate, N-butanol, Ethanol, methanol and Aqueous) presence of alkaloids, flavonoids, saponins, tannins, sugars, Phenol, Terpenoids, Quinones, Anthocyanins, oxalates and glycosides. [2] Generally the phytochemicals of the plant extract, do not have any side effects, and can cure a number of human diseases and disorders. [3] These phytochemicals belongs to different chemical groups and have the capability to inhibit the *in vitro* growth of microorganisms. [4] The medicinal importance of plant materials is due to the secondary metabolites present in the plant. [5] There are reports of leaf extract of *Melia azedarach* showing anti inflammatory, Immuno modulatory, hypoglycemic properties. [6, 8] The present study was undertaken, to evaluate the Phytochemical screening and antimicrobial activity of aqueous and methanol leaf extract of *Melia azedarach*.

**MATERIALS AND METHODS*****Plant material***

The plant material *Melia azedarach* (fig.3) used for the study was obtained from Pakhal wild life sanctuary, Kothaguda Mandal, Warangal district of Telangana state, India. The plant material was identified botanically, authenticated by referring the standard taxonomic characteristic features.

***Preparation of leaf extract***

Fresh leaf material leaves of *Melia azedarach* were thoroughly cleaned with water to remove dust particles and shade – dried at room temperature and reduced to coarse powder using a mechanical mixer. The powder was subjected to extraction by maceration using various solvents like Acetone, Methanol and Aqueous to obtain their respective extracts. To 10gm of the dried plant powder in 100ml solvent (Ethyl acetate, N-butanol, Ethanol, methanol and Aqueous) was added and stirred occasionally in orbital shaker. The mixture was filtered on the second day and the solvent was evaporated at room temperature for 18-24 hours to obtain a solid mass, which are stored in refrigerator (4°C) for further use.

**PHYTOCHEMICAL SCREENING**

Phytochemical Screening Preliminary phytochemical analysis carried out using the standard methods [7].

**Test for Alkaloids (Wagner's reagent)**

A fraction of extract was treated with 3-5drops of Wagner's reagent and observed for the formation of reddish-brown precipitate or colouration.

**Test for glycosides****Keller Kelliani's test**

5ml of each extract was treated with 2ml of glacial acetic acid in a test tube and a drop of ferric chloride solution was added to it. This was carefully under layer with 1ml concentrated sulphuric acid. A brown or violet ring may appear below the ring while in the acetic acid layer, a greenish ring may form.

**Guignard's test**

2 gm of the plant extract was taken in a test tube and 5 ml of distilled water was added in it. With the help of the



**Srinivas Reddy Annem**

cork, sodium picrate paper strip was hung in the test tube above the extract. The test tube was incubated in the water bath at temperature up to 40°C. Appearance of reddish or brick red color shows the presence of cardiac glycosides.

**Erdmann's test**

200 gm extract was taken and mixed with methanol and filtered. The residual portion was taken and 3 drops of Erdmann's reagents were added into it. Appearance of the bright red color shows the presence of phenolic glycosides.

**Borntrager's test**

Filtrate was shaken with chloroform and the organic layer was separated. Organic layer was taken in test tube and dilute ammonia solution was added in it. Formation of the pink color in the lower layer shows the presence of glycosides.

**Test for Anthraquinones Glycosides**

0.5 g of the extract was taken in test tube, boiled with 10 ml of sulphuric acid and filtered. Filtrate was taken and shaken with 5 ml of chloroform. With help of the pipette chloroform layer was transferred into another test tube and 1 ml of diluted ammonia was added in it and observed for color change.

**Test for Phenols**

5 ml of extract was taken in test tube and 2 ml of 5% sodium nitrate and 2 ml of 5% glacial acetic acid was added and observed for color change.

**Test for Flavonoids (Alkaline reagent test):** 2ml of extracts was treated with few drops of 20% sodium hydroxide solution. Formation of intense yellow colour, which becomes colourless on addition of dilute hydrochloric acid, indicates the presence of flavonoids.

**Test for Phenols (Ferric chloride test)**

A fraction of the extracts was treated with aqueous 5% ferric chloride and observed for formation of deep blue or black colour.

**Test for Saponins (Foam test)**

To 2ml of extract was added 6ml of water in a test tube. The mixture was shaken vigorously and observed for the formation of persistent foam that confirms the presence of saponins.

**Test for Tannins (Braymer's test)**

2ml of extract was treated with 10% alcoholic ferric chloride solution and observed for formation of blue or greenish colour solution.

**Test for Terpenoids (Salkowski's test)**

1ml of chloroform was added to 2ml of each extract followed by a few drops of concentrated sulphuric acid. A reddish-brown precipitate produced immediately indicated the presence of terpenoids.

**Test for Quinones**

A small amount of extract was treated with concentrated HCL and observed for the formation of yellow precipitate or colouration.

**Preparation of *Melia azedarach* aqueous extract for antimicrobial activity**

10 grams of dried leaf powder of *Melia azedarach* was added to 100 ml of distilled water and mixed thoroughly by a glass rod. After 24 hours, the supernatant was collected and concentrated to prepare the plant crude extract. It was stored at 4°C. [9]







### Srinivas Reddy Annem

#### Preparation of *Melia azedarach* methanol extract for antimicrobial activity

10 grams of leaf powder of *Melia azedarach* was added to 100 ml of methanol in a conical flask plugged with cotton. After 24 hours, the supernatant was collected and the solvent was evaporated to prepare the plant crude extract and stored at 4°C. [10]

#### Microbial culture

The bacteria were maintained on nutrient agar slants, sub-cultured periodically and preserved at 4°C prior to use. The fungus was maintained on Sabouraud Dextrose Agar (SDA) slants, sub-cultured periodically and preserved for future use.

#### Antimicrobial susceptibility test

The antibacterial assay was performed by disk diffusion method. [11] This method is a simple and reliable test in clinical bacteriology. Circular discs of 6 mm diameter was prepared from Whatman No. 1 filter paper and sterilized in an autoclave. Each paper disc was soaked into the prepared aqueous and methanol leaf extract concentrations (50, 75 and 100 mg) separately by using dimethylsulfoxide (DMSO) and left overnight in the respective solvent. [11] Mueller-Hinton agar medium is the growth medium used for antibacterial assay. It is prepared by dissolving 34 gms of Mueller-Hinton agar powder in one liter of demineralized water. The media was autoclaved for 18 minutes and then poured in sterilized plates at a concentration of 15 mL each. The plates were allowed to solidify for 5 minutes. 0.1% of 1ml bacterial inoculum suspension was swabbed uniformly with cotton swab. Inoculum was allowed to dry for 5 minutes. Preloaded different concentrations extract disc was placed on the surface of the medium and the compound was allowed to diffuse for 5-10 minutes.

The plates were incubated at 37°C for 24 hrs. After 24 hours the zone of inhibition around each disc was measured and recorded. Each extract was tested in triplicates. Streptomycin (30 mcg /disc) was used as positive control. The antifungal assay was determined by Paper disk agar diffusion method. Circular discs of 6 mm diameter was prepared from Whatman No. 1 filter paper and sterilized in an autoclave. Each paper disc was soaked into the prepared aqueous and methanol leaf extract concentrations (50, 75 and 100 mg) separately by using dimethylsulfoxide (DMSO) and left over night in the respective solvents. Sabouraud Dextrose Agar (SDA) medium is the growth medium used for antifungal assay. It is prepared by dissolving peptone, dextrose in distilled water by gentle heating. Agar was also added. The media was autoclaved for 15 minutes and then poured in sterilized plates at a concentration of 15 ml each. The plates are allowed to cool and solidify. The plates are inoculated with spore suspension of *Melia azedarach*. Preloaded different concentrations extract disc was placed on the surface of the medium and the compound was allowed to diffuse for 5-10 minutes. The plates were incubated at 30°C for 48 hrs. [12] The diameter of growth inhibition zone around each disc was measured. The experiment was conducted in triplicates. Nystacin (30 mcg/disc) was used as positive control.

## RESULTS AND DISCUSSION

Different tests were performed for phytochemical screening. *Melia azedarach* leaf extracts (Ethyl acetate, N-butanol, Ethanol, methanol and Aqueous) Results showed presence of saponins, anthraquinone glycosides, cardioactive glycosides, phenolic glycosides, cynogenic glycosides, phenols, alkaloids, tannins, flavonoids and terpenoids as given in Table 1. Table-2 and Chart-1 confirms the antimicrobial activity of aqueous and methanol leaf extract of *Melia azedarach*. The inhibitory activity is due to the phytochemical constituents present in the leaf extract. The inhibitory activity is dose dependent. The phytochemical constituents present, vary in different types of solvent extracts, thus showing variation in their inhibitory activity. The methanol leaf extract showed promising inhibitory activity compared to aqueous extract. The zones of inhibition were found to be between 7 mm to 15 mm at 50 mg/mL, 75 mg/mL, & 100 mg/mL leaf extract concentrations. Methanol leaf extract at 100 mg/mL showed maximum inhibitory activity against *C. albicans* (14.16 mm), *S. aureus* (15.00 mm), *E. coli* (13.33 mm) *P. aeruginosa* (14.16 mm). Aqueous extracts showed moderate activity against *S. aureus* (14.16 mm), *E. coli* (12.00 mm), *P. aeruginosa* (13.33 mm),



**Srinivas Reddy Annem**

*C. albicans* (13.16 mm). The minimum inhibition may be because of the low concentration of plant extracts used. TableNo.3. and figure no. 2 .The zone of inhibition shown, by use of plant extract is almost same to standard drug. Thus it shows the potential ability of plants, to be used as drugs in cure of human diseases caused by microorganisms.

**CONCLUSION**

The present study concluded that *Melia azedarach leaf extracts* (Ethyl acetate, N-butanol, Ethanol, methanol and Aqueous) Results showed presence of saponins, anthraquinone glycosides, cardioactive glycosides, phenolic glycosides, cynogenic glycosides, phenols, alkaloids, tannins, flavonoids and terpenoids. The methanol leaf extract of *Melia azedarach* showed significant antibacterial activity against *Staphylococcus aureus*, *Pseudomonas aeruginosa*, *Escherichia coli* and antifungal activity against *Candida albicans*. The phytochemical constituent present in the leaf extract is responsible for the antimicrobial activity. The activity of plant extract was equivalent to standard drug. This proves the therapeutic potential of the leaf extract of *Melia azedarach* for its use as a drug against microbial infections.

**REFERENCES**

1. Yadaw RNS and Agarwala M. Phytochemical analysis of some medicinal plants. Journal of Phytology, 2011; 10-14.
2. Prashant Tiwari B, Kumar MK, Gurpreet Kaur HK. Phytochemical screening and extraction - A review. International Pharmaceutical Sciencia, 2011; 1(1): 98–106.
3. Srinivasan D, Perumalashamy LP, Nathan ST. Antimicrobial activity of certain Indian medicinal plants used in folkloric medicine. Journal of Ethnopharmacol, 2001; 94: 217-222.
4. Han, J., Lin, WH., Xu, RS, Wang, WL. and Zhao, SH., Studies on the chemical constituents of *Melia azedarach* L. Acta Pharm. Sin. 1991; 26:426-429.
5. Ugochukwu S C. and Uche A. Preliminary phytochemical screening of different solvent extracts of stem bark and roots of *Dernetiatripetala*. Asian Journal of Plant Science and Research, 2013: 10-13.
6. Sultana S, Asif HM, Akhtar N, Waqas M, Rehman SU. Comprehensive Review on ethanobotanical uses, phytochemistry and pharmacological properties of *Melia azedarach* Linn. Asian Journal of Pharmaceutical Research and Health Care. 2014; 6(1).
7. P. Suhag, Merrra and S.B. Kalidhar. Phytochemical investigation of *Melia azedarach* leaves. J. Med. Aromatic Plant Sci. 2003; 25(2): 397-399.
8. Corpinella MC, Miranda M, Almiron WR, Ferrayoli CG, Almedia FL, Palacios SM. In vitro pediculicidal and ovicidal activity of an extract and oil from fruit of *Melia azedarach* L. J Am Acad Dermatol 2007; 250-256.
9. Wandscheer CB, Duque JE, Dasilva MA, et al. Larvicidal action of ethanolic extracts from fruits endocarps of *Melia azedarach* and *Azadirachta indica* against the dengue mosquito *Aedes Aegypti*. Toxicol 2004; 44: 829-835.
10. Khan AV, Ahmed QU, Mir MR, Shukla I, Khan AA. Antibacterial efficacy of the seed extracts of *Melia azedarach* against some hospital isolated human pathogenic bacterial strains. Asian Pacific Journal of Tropical Biomedicine. 2011; 1(6):452-455.
11. Khan AV, Khan AA, Shukla I. *In vitro* antibacterial potential of *Melia azedarach* crude leaf extracts against some human pathogenic bacterial strains. Ethnobotanical Leaflets. 2008; (1):53-55.
12. Sultana S, Akhtar N, Asif HM. Phytochemical screening and antipyretic effects of hydro-methanol extract of *Melia azedarach* leaves in rabbits. Bangladesh Journal of Pharmacology. 2013; 8(2):214-217.





## Srinivas Reddy Annem

Table.1. Phytochemical analysis of *Melia azedarach* Leaf extracts

Chemical groups	Ethyl acetate	N-butanol	Ethanol	Methanol	Aqueous
Saponin	+	++	+++	+++	+
Antraquinone glycosides	-	+	+	+	+
Cyanogenic glycoside	+	++	+++	+++	-
Cardio active Glycosides	-	-	+	+	-
Cardioave Glycosids	-	-	+	+	+
Phenols	+	+	+	+	+
Alkaloids	+	+	-	-	+
Tannins	-	+	+	+	-
Flavonoids	-	+	+	+	+
Terpenoids	-	+	+	+	+

\* (+) Present, moderate (++) , (+++) highly present, (-) absent

Table: 2 - Antimicrobial activity of *Melia azedarach*.

Microorganisms	Zone of Inhibition (mm)					
	Concentration of Extract(mg/2ml)					
	50(mg)		75(mg)		100(mg)	
	Aq	Me	Aq	Me	Aq	Me
S. aureus	7.00±0.57**	8.16±0.76**	11.16±0.28**	12.33±0.57**	14.16±0.76**	15.00±0.86**
P.aeruginasa	7.16±0.28**	8.00±0.86**	10.33±0.57**	11.00±0.86*	13.33±0.57**	14.16±0.76**
E.coli	-	7.33±0.28*	9.16±0.76**	9.16±0.86**	12.00±0.86**	13.33±0.57**
C. albicans	7.00±0.86**	7.16±0.28*	10.00±0.86**	11.16±0.76**	13.16±0.28**	14.16±0.28**

All values are expressed as Mean ± SD, \*p<0.05, \*\*p<0.01, NS-Non significance when compared to the control. Aq- aqueous extracts, Me-methanol extracts, (- no inhibition)

Table: 3 Antimicrobial Activities of Standard Drugs

Microorganisms	Zone of Inhibition (mm)	
	SM	NC
S.aureus	16	N.T
P.aeruginosa	15	N.T
E.Coli	14	N.T
C.albicans	N.T	15

SM- Streptomycin (10mcg/disk), NC- Nystacin (30 mcg/disk), N.T – Not tested





**Srinivas Reddy Annem**

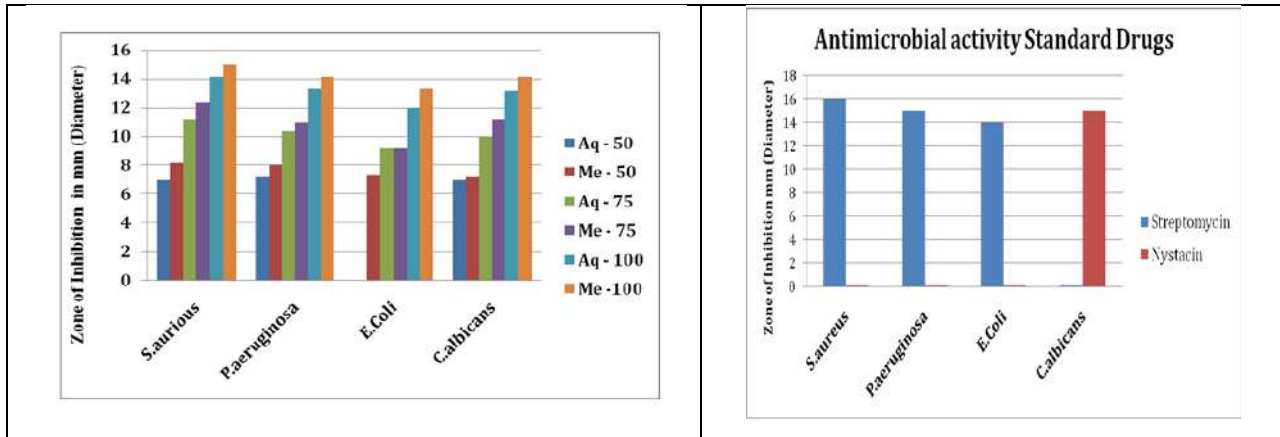


Fig: 1 - Antimicrobial activity of *Melia azedarach*.  
 Aq- aqueous extracts, Me – methanol Extracts.

Fig: 2 - Antimicrobial activity of Standard Drugs



Fig.3-*Melia azedarach*





## Comparative Analysis of Cold Maceration and Soxhlet Extraction Methods for Assessing Secondary Metabolites in *Gnidia glauca* (Fresen).Gilg

Gayathri S S<sup>1\*</sup> and Raveendran P B<sup>2</sup>

<sup>1</sup>Research Scholar, Post Graduate Department of Botany and Research Centre, Mahatma Gandhi College, Kesavadasapuram, Thiruvananthapuram (Affiliated to University of Kerala) Kerala, India.

<sup>2</sup>Assistant Professor, Department of Botany, N.S.S College, Cherthala, Alappuzha, (Affiliated to University of Kerala) Kerala, India.

Received: 04 Aug 2023

Revised: 10 Feb 2024

Accepted: 29 Apr 2024

### \*Address for Correspondence

**Gayathri S S**

Research Scholar,

Post Graduate

Department of Botany and Research Centre,

Mahatma Gandhi College,

Kesavadasapuram, Thiruvananthapuram

(Affiliated to University of Kerala)

Kerala, India.

Email: gayathriss28@gmail.com



This is an Open Access Journal / article distributed under the terms of the **Creative Commons Attribution License** (CC BY-NC-ND 3.0) which permits unrestricted use, distribution, and reproduction in any medium, provided the original work is properly cited. All rights reserved.

### ABSTRACT

Plant secondary metabolites possess significant therapeutic properties, making them highly valuable in the business sector. Recent interest has focused on their synthesis and proposals for expanding production. The selection of an appropriate solvent system, extraction process, and phytochemical screening protocols is critical for generating high-quality biologically active compounds. Quantitative analysis plays a pivotal role in identifying compounds found in plants. This study investigates the impact of different extraction procedures, specifically Soxhlet and Cold maceration, on the quality of *Gnidia glauca* (Fresen.) Gilg extracts. Sequential extraction of plant parts, including leaves and bark, was conducted using a hot solvent extraction method with a Soxhlet apparatus and a sequential Cold maceration method. The extracts were analyzed for secondary metabolites using different solvents. The study aimed to evaluate the extractive yield, tannin content, and alkaloid content using these two extraction techniques.

**Keywords:** Alkaloids, *Gnidia glauca*, Secondary metabolites, Tannin, Thymelaeaceae





## INTRODUCTION

Plants, used by humans since ancient times, serve diverse purposes like food, fodder, medicine, and drug discovery [1-2]. Surprisingly, even toxic plants can have therapeutic potential in controlled doses[3]. Secondary metabolites, such as phenolics, flavonoids, and tannins, are crucial for plant defense [4-5] and hold significant bioactive importance[6-7]. *Gnidia glauca*, a member of the Thymelaeaceae family [8-9], is commonly referred to as fish poison bush [10] and belongs to the genus *Gnidia*. Widely distributed in Africa, India and Sri Lanka [9,11], it is represented by two species in India and is found throughout the Western Ghats [12]. In the Kerala region, it is known as "Nanju." [13] *Gnidia glauca* demonstrates larvicidal [14], insecticidal, antibacterial, antitubercular [15], and piscicidal properties[16], and is used in traditional medicine for treating snake bites [17]. This study employs two extraction techniques, Cold Sequential Maceration and Sequential Soxhlet Extraction, to evaluate extraction yield and quantify secondary metabolites such as tannin and alkaloid in the respective sample extracts.

## MATERIALS AND METHODS

### Collection and extraction of plant material

The plant material, consisting of fresh leaves and stem bark, was collected from Kerala. Subsequently, the plant samples were washed under running water, dried in the shade at room temperature and then powdered using a grinder.

### Cold Sequential Extraction [18] and Soxhlet extraction [19-20]

In both Soxhlet and Cold extraction methods, thirty grams of powdered samples (leaves and stem bark) underwent sequential extraction with solvents - petroleum ether, chloroform, acetone, methanol, and aqueous (distilled water). Each extraction, used 300 mL of solvents, and Cold extractions were conducted at room temperature in darkness for four days. The resulting extracts were filtered, and the residue was dried for subsequent extraction with the next solvent in the sequence. All extracts from both Soxhlet and cold extraction methods were stored at 4°C for future studies. [19-20].

### Extraction Yield

The extraction yield was estimated using [21]

## QUANTITATIVE ANALYSIS OF PHYTOCHEMICALS

### Total tannin content

The tannin content of the extracts was evaluated using the Folin-ciocalteu method described by Selvakumar *et al.* [22], with tannic acid serving as the reference standard for this assay.

### Total Alkaloid Content

The alkaloid content of *Gnidia glauca* extracts (leaf and bark) was assessed using the 1,10-Phenanthroline method of Kamble *et al.* [23]. with minor modifications and alkaloid content was determined using a caffeine standard graph [24].

### Calculations

Total tannin and Total Alkaloid content in the leaf and bark extracts of *Gnidia glauca* was computed using the formula:-  $C = cxV/M$  (1), C- total tannin/alkaloid content in mg/g, c-concentration of tannic acid/caffeine calculated from the calibration curve in mg/mL, V-volume of extract used in mL and M stands for total weight of the extract in gram [25-26].





## Gayathri and Raveendran

**Statistical Analysis**

All experiments were conducted in triplicate with standard error. Using MS Office Excel 2016, the linear correlation coefficient ( $R^2$ ) was calculated using the equation  $y=mx+c$ , where  $y$  is the absorbance of the plant extract,  $m$  is the calibration curve slope,  $c$  is the intercept, and  $x$  is the concentration of extracts in  $\mu\text{g}$ . This regression equation determined concentration values [25]. Statistical analysis used R Software (Version 4.3.1) with a significance level set at  $p < 0.05$ . Spearman's correlation analysis assessed the correlation between extractive yield with tannin and alkaloid content in Soxhlet extracts

**RESULTS AND DISCUSSION**

The medicinal potential of plants relies on secondary metabolites. Bioactive compounds' effects on solubility, extraction yield, and antioxidant activity vary with extraction solvents [27]. Effective techniques maintain extract characteristics [28-29], calculated by comparing masses [30]. Recent studies explore biological activity from different methods[31-32]. Extraction choice depends on sample and efficiency [31, 33]. "Cold extraction" denotes a method without heat, where raw material soaks in a solvent with stirring. In contrast, Soxhlet extraction uses heat based using different theoretical principles, yielding varied quantities and qualities of extracts [34]. Extractive yield percentages for Cold and Soxhlet extraction were calculated and presented in Table 1. Polar and Nonpolar solvents like petroleum ether, chloroform, acetone, methanol, and aqueous (distilled water) were employed in both methods. Figure 1 indicates increased extractive yield with solvent polarity. Aqueous extracts demonstrated the highest extraction efficacy in both extraction techniques, while petroleum ether bark extracts exhibited lower yield concentrations. Analyzing the extractive yield results, it is evident that higher polarity solvents yield higher extractive yield. The variation in extractive yield could be particular to the different extraction techniques employed in this research. Zaho *et al.* [35] also reported higher extractive yield in water extracts of *Castanea mollissima*. Similar findings were reported by Devkota *et al.*[36] in *Mikania micrantha*. In this study, Soxhlet extraction was found to be more effective than maceration. These results align with the outcomes of Nwonuma *et al.* [37], who noted a higher percentage of yield in aqueous extracts. These findings suggest that polar compounds are better extracted in aqueous solvents due to their high polarity[38]. Kapure *et al.*[39] reported higher yields with the Soxhlet method compared to maceration. Similarly, Khan *et al.* [40] identified higher extractive yields with Soxhlet extraction compared to Cold maceration. Tannins are natural compounds synthesized by plants and possess antioxidant, antimicrobial, anti-diarrheal, anti-inflammatory, antiviral, and antiparasitic properties[41].

They are used for treating sore throat, bronchitis, and inflammation [42]. Moreover, they play a significant role as antihemorrhagic agents and have been associated with anti-hypercholesterol, hypotensive, and cardiac depressant properties [43]. Therefore, the tannin content of leaf and bark extracts was determined using different solvents. Astringency in many plant species is attributed to tannins[44-45] . Table 2 and Figure 2 present tannin content results. A tannic acid solution (concentrations: 25 to 250  $\mu\text{g/mL}$ ) showed Beer's Law at 700 nm, with an  $R^2$  of 0.9925. The plot's slope ( $m$ ) was 0.002, and the intercept ( $c$ ) was 0.0081, leading to the standard curve equation  $y = 0.002x + 0.0081$ . Formula (1) calculated total tannin content. Our data revealed that acetone extracts obtained through Soxhlet extraction exhibited the highest tannin content. The results are in agreement with Sung *et al.*[46], who reported higher tannin concentrations in acetone extracts of agricultural by-products compared to other solvents. Basher *et al.* [47] also reported higher tannin content in acetone extracts of *Acacia nilotica* seeds compared to other solvents. Dhull *et al.* [48] found that compared to ethanol, methanol, and chloroform extracts, acetone extracts contained the highest tannin content in *Origanum majorana* seeds. However, no tannin content was observed in cold macerated petroleum ether (leaf and bark) and chloroform (bark) extracts. Table 3 and Figure 3, presents the alkaloid content in the extracts. The total alkaloid in *Gnidia glauca* extracts was determined from the calibration curve using the regression equation  $Y = 0.0026x + 0.1075$ , where  $R^2 = 0.9902$ , and the formula (1). The results pointed out that the highest alkaloid content was observed in chloroform extracts of Soxhlet bark ( $387.30 \pm 0.61$  mg/g). The phenanthroline method of alkaloid estimation involves oxidizing alkaloids in an acid solution with iron(III) and subsequently complexing iron(II) with 1,10 phenanthroline, resulting in a red-colored complex with maximal absorption at 510 nm [49].



**Gayathri and Raveendran**

Wintola *et al.* [50] reported that acetone extracts of *Aloe ferox* exhibited higher alkaloid content compared to aqueous, methanol, and ethanol extracts. Dutta and Gogoi [51] found alkaloid contents in the range of 393.5 mg/g, 220 mg/g, and 400 mg/g in leaf, stem, and root extracts of *Aristolochia roxburhiana* Klotzsch. Our findings indicate that *Gnidia glauca* is abundant in secondary metabolites, particularly alkaloids. Alkaloids, composed of nitrogen atoms, are a type of secondary metabolite with diverse biological effects, such as analgesic, muscle relaxant, and antioxidant properties [52]. Throughout history, alkaloids have been employed for medicinal purposes, proving effective in treating serious diseases. They were historically used in liquid medications and poisons[53]. Plant extracts containing alkaloids were utilized in ancient times for various ailments, including snakebites, fevers, and mental illnesses. While highly toxic in large doses, alkaloids exhibit significant therapeutic effects in small doses [54].

**Spearman's Correlation Analysis**

The Soxhlet extraction method yielded higher extractive yield, tannin, and alkaloid compared to cold extracts, prompting a correlation study specifically for the Soxhlet extraction. Despite acetone extracts having lower polarity and extractive yield compared to methanol and water, they exhibited a significant tannin content. Spearman's rank correlation analysis ( $p < 0.05$ ) in Table 4-5 indicated a negligible and low positive correlation between extractive yield and tannin content in Soxhlet extracts. This implies that a higher extractive yield doesn't necessarily signify higher tannin content, as the latter depends on the presence of active tannin components. Studies have shown that a high yield doesn't always correspond to high antioxidant activity, emphasizing the importance of specific antioxidant compounds[55]. The weak correlation suggests that tannin solubility is influenced by multiple factors beyond just polarity.

**CONCLUSIONS**

*Gnidia glauca*, a traditional ethnomedicine, was studied for its efficacy using various organic solvents and extraction techniques. Cold maceration and Soxhlet extraction were compared for yield, tannin, and alkaloid content. Results showed significant variations in phytochemical analysis, with Soxhlet extraction exhibiting the highest yield and content. Tannin and alkaloid quantities varied based on extraction methods, with Soxhlet method being preferred. These findings confirmed bioactive phytochemicals in *Gnidia glauca*, suggesting selective extraction can enhance biological efficacy. Further studies are recommended for investigating *Gnidia glauca* components and elucidating novel bioactive compounds from the plant.

**FUTURE SCOPE**

The selected plant possesses a diverse array of phytochemicals, each exhibiting various biological properties such as antioxidant and radical scavenging abilities. Given this broad spectrum of phytochemicals, further studies are warranted to explore the medicinal and toxicological aspects associated with their presence.

**ACKNOWLEDGEMENT**

The authors express gratitude to the Principal and Head of the Department of Botany at Mahatma Gandhi College, Kesavadasapuram, Kerala, for facilitating the research. Monetary assistance from the University of Kerala is also acknowledged.

**CONFLICT OF INTEREST:** None







## REFERENCES

- Jain C, Khatana S & Vijayvergia R. Bioactivity of secondary metabolites of various plants: a review. *IJPSR*. 2019;10(2), 494-504.
- Petrovska BB. Historical review of medicinal plants' usage. *Pharmacogn Rev*.2012; 6(11): 1-5.
- Tamilselvan N, Thirumalai T, Shyamala P & David E. A review on some poisonous plants and their medicinal values. *J.Acute Dis*. 2014; 3: 85-89.
- Diveka, PA, Narayana S, Divekar BA, Kumar R, Gadratagi BG, Ray A, et.al. Plant secondary metabolites as defense tools against herbivores for sustainable crop protection. *Int. J. Mol. Sci*. 2022; 23(5): 1-23.
- Mazid M, Khan TA & Mohammad F. Role of Secondary metabolites in defense mechanisms of plants. *Biology and Medicine*, 2011; 3(2): 232-249.
- Walia A, Gupta AK & Sharma V. Role of bioactive compounds in human health. *ASMS*. 2019; 3(9): 25-33.
- Alamgir ANM. Pharmacognostical Botany: Classification of Medicinal and Aromatic Plants (MAPs), Botanical Taxonomy, Morphology, and Anatomy of Drug Plants. In *Therapeutic Use of Medicinal Plants and Their Extracts*; Springer. 2017;1, 177–293.
- Momo SMC, Avana ML, Ngueguim JR & Kemeuze VA. Wood characterization of *Gnidia glauca* (Fresen.) gilg (Thymelaeaceae) and its possible utilization as material for pulp production in Northwest Cameroon. *Revue Scientifique et Technique Forêt et Environnement du Bassin du Congo-RIFFEAC*. 2017; 8, 36-44.
- Junaid S, Dileep N, Rakesh KN, Pavithra GM, Vinayaka KS & Kekude TRP. Anticariogenic Activity of *Gnidia glauca* (Fresen.) Gilg, *Pothos scandens* L. and *Elaegnus kologa* Schlecht. *J. Appl. Pharm. Sci*.2013; 3(3): 020-023.
- Jebet WM. Bioefficacy of organic extracts of fish poison bush (*Gnidia glauca*, Fresen) against cowpea weevil (*callosobruchus maculatus*, fabricus). Thesis submitted to the award of Master of science, Kenyatta University. 2018.
- Gawande V & Jarande S. Anticancer activity of *Gnidia glauca* bark extracts against MCF-7 cell lines and isolation of a lignan as the marker compound. *JPC*. 2019; 32(3): 223-229.
- Godhgate AG, Patil RS & Sawant RS. *Gnidia glauca* (Fresen) Gilg: Phytochemical and antibacterial view. *Int. J. Recent Sci. Res*. 2015; 6, 4854-4857.
- Sasi AS. & Mohan M. Piscicidal plants used by Malai Pandaram tribes in Achankovil river basin, Kerala: An ethnobiological approach. *Int. j. adv. res*, 2018;6: 726-732.
- Nethravathi HR, Kekuda TP, Vinayaka KS, Thippeswamy NB, Sudharshan SJ & Kumar SP. Studies on antioxidant and anthelmintic activity of *Gnidia glauca* (Fresen) Gilg. *Asian Journal of Bio Science*, 2010; 5(1): 6-9.
- Gowrish A, Vagdevi HM & Rajashekar H. (2016). Antibacterial and Antitubercular Activity of *Gnidia glauca* (Fresen) Gilg root extract. *JOAC*, 2016; 2(5): 186-191.
- Rao SB, Jayanthi M, Yogeetha R, Ramakrishnaiah H & Nataraj J. Free radical scavenging activity and reducing power of *Gnidia glauca* (Fresen.) Gilg. *J. Appl. Pharm. Sci*. 2013;3(6): 203-207.
- Ghosh S, Parihar VS, Dhavale DD & Chopade BA. Commentary on therapeutic potential of *Gnidia glauca*: a novel medicinal plant. *Med. Chem*, 2015; 5: 351-353.
- Dharajiya D, Pagi N, Jasani H & Patel P (2017). Antimicrobial activity and phytochemical screening of *Aloe vera* (*Aloe barbadensis* Miller. *Int J Curr Microbiol Appl Sci* 6(3): 2152-62.
- Gopalasatheeskumar, K. (2018). Significant role of Soxhlet extraction process in phytochemical research. *Mintage j. pharm. med. sci*. 2017; 7:43-47.
- Azwanida NN. (2015). A review on the extraction methods use in medicinal plants, principle, strength and limitation. *med. aromat. plants*. 2015; 4: 2167-0412.
- Muhamad SHA, On S, Sanusi SN, Hashim AA, Zai MA. Antioxidant activity of Camphor leaves extract based on variation solvent. In *Journal of Physics: Conference Series* (Vol. 1349, No. 1, 012102). IOP Publishing. 2019.
- Selvakumar S, Vimalanban S & Balakrishnan G. (2019). Quantitative determination of phytochemical constituents from *Anisomeles malabarica*. 2019; 6(1), 19-21.
- Kamble V & Gaikwad VN. Fluorescence analysis, phytochemical and antioxidant activities in leaves and stem of *Embelia ribes* Burm. F. *Asian J Pharm Clin Res*. 2019;12: 225-229.





### Gayathri and Raveendran

24. John BIJU, Sulaiman CT, George S & Reddy VRK. Spectrophotometric estimation of total alkaloids in selected *Justicia* species. *Int J Pharm Pharm Sci.* 2014; 6(5), 647-648.
25. Poudel M & Rajbhandari. Phytochemical analysis of *Ampelopteris Prolifera* (Retzius) Copeland. *NAST.* 2020; 19(1): 78-88.
26. Shakyawar S, Sundaram S, Gupta E & Alok S. Phytochemical evaluation and determination of antioxidant activity in different parts of *Aegle marmelos*. *IJPSR.* 2020; 11(11): 5898-911.
27. Ngo TV, Scarlett CJ, Bowyer MC, Ngo PD, & Vuong QV. Impact of different extraction solvents on bioactive compounds and antioxidant capacity from the root of *Salacia chinensis* L. *J. Food Qual.* 2017; 1-8
28. Dhanani T, Shah S, Gajbhiye NA & Kumar S. Effect of extraction methods on yield, phytochemical constituents and antioxidant activity of *Withania somnifera*. *Arab. J. Chem.* 2017; 10, S1193-S1199.
29. Quispe-Candori S, Foglio MA, Rosa PTV. & Meireles MAA. Obtaining b-caryophyllene from *Cordia verbenacea* de Candolle by super critical fluid ex-traction. *J. Supercrit. Fluids.* 2008; 46(1): 27-32.
30. Zhang SQ, Bi HM & Liu CJ (2007). Extraction of bio-active components from *Rhodiola sachalinensis* under ultrahigh hydrostatic pressure. *Sep. Purif. Technol.* 2007; 57 (2):277-282.
31. Kapadia P, Newell AS, Cunningham J, Roberts MR & Hardy JG. Extraction of High-Value Chemicals from Plants for Technical and Medical Applications. *Int. J. Mol. Sci.* 2022; 23(18): 10334.
32. Gupta A, Naraniwal M & Kothari V. Modern extraction methods for preparation of bioactive plant extracts. *IJANS.* 2012; 1(1), 8-26.
33. Tzanova M, Atanasov V, Yaneva Z, Ivanova D & Dinev T. Selectivity of Current Extraction Techniques for Flavonoids from Plant Materials. *Processes.* 2020; 8(10):1222.
34. Neoh B, Thang YM & Zain MZM & Junaidi A. (2011). Palm pressed fibre oil: A new opportunity for premium hardstock?. *Int. Food Res. J.* 18. 769-773.
35. Zhao S, Liu JY, Chen SY, Shi LL, Liu YJ, & Ma C. Antioxidant potential of polyphenols and tannins from burs of *Castanea mollissima* Blume. *Molecules.* 2011; 16(10): 8590-8600.
36. Devkota A, & Sahu A. Antimicrobial activities and phytochemical screening of leaf extract of *Mikania micrantha* HBK. *J. Nat. Hist. Mus.* 2018; 30, 274-286.
37. Nwonuma CO, Adelani-Akande TA, Osemwegie OO, Olaniran AF & Adeyemo TA. Comparative Study of in vitro antimicrobial potentials and phytochemicals of some medicinal plants. *F1000 Research.* 2019; 8(81):1-17.
38. Razak MFBA, Yong PK, Shah, ZM, Abdullah LC, Yee SS & Yaw ITCS. The effects of varying solvent polarity on extraction yield of *Orthosiphon stamineus* leaves. *J Appl Sci.* 2012;12(11): 1207-1210.
39. Kapure PL, Makade KP, Sanap MD, Gandhi SJ, Ahirrao, RA & Pawar SP. Various Extraction Method and Standardization Parameter of Amla and Durva, *PSM.* 2015; 6(2):61-72.
40. Khan W, Bakht J, Nair MG, Uddin MN & Shafi M. Extraction and isolation of important bioactive compounds from the fruit of *Physalis ixocarpa*. *Pak. J. Pharm. Sci.* 2018; 31(6): 2463-2469.
41. Maitera ON, Louis H, Oyebanji OO & Anumah AO. Investigation of tannin content in *Diospyros mespiliformis* extract using various extraction solvents. *J. anal. pharm. res.* 2018; 7(1): 55-59.
42. Araújo TAS, Alencar NL, Amorim ELC, Albuquerque UP. A new approach to study medicinal plants with tannins and flavonoids contents from the local knowledge. *J Ethnopharmacol.* 2008; 120(1), 72-80.
43. Mohan PR & Savithamma N. Estimation of total phenol and tannin content present in the leaf, bark and fruits of an endemic semi-evergreen tree species *Terminalia pallida* Brandis. *Pharma innov.* 2019; 8(5): 518-522.
44. Amorim EL, Nascimento JE, Monteiro JM, Peixoto STJS, Araújo TA & Albuquerque UP. A simple and accurate procedure for the determination of tannin and flavonoid levels and some applications in ethnobotany and ethnopharmacology, *FEC.* 2008; 2(1): 88-94.
45. Santos SC, Mello JCP, Taninos. In: Simões CMD, Schenkel EP, Gosmann G, Mello JCP, Mentz LA, Petrovick PR (Eds) *Farmacognosia: Da Planta ao Medicamento*, Editora da UFRGS/UFSC, Porto Alegre/Florianópolis, 615-656.2004
46. Sung SH, Kim KH, Jeon BT, Cheong SH, Park JH, Kim DH, et.al. Antibacterial and antioxidant activities of tannins extracted from agricultural by-products. *J. Med. Plant Res.* 2012; 6(15): 3072-3079.
47. Basher ZA, Munayr ZAS & Mahraz SM. (2020). Determination of Tannin Content of Seeds of *Acacia Nilotica* with concentration different solvents. *IOSR-JAP.* 2020; 12(5): 30-33.





### Gayathri and Raveendran

48. Dhull SB, Kaur P & Purewal SS. Phytochemical analysis, phenolic compounds, condensed tannin content and antioxidant potential in Marwa (*Origanum majorana*) seed extracts. *Resource-Efficient Technologies*. 2016; 2:168-174.
49. Singh DK, Srivastava B & Sahu A. Spectrophotometric determination of Rauwolfia alkaloids: estimation of reserpine in pharmaceuticals. *Anal. Sci.* 2004; 20(3): 571-573.
50. Wintola, OA & Afolayan AJ. Phytochemical constituents and antioxidant activities of the whole leaf extract of *Aloe ferox* Mill. *Pharmacogn. Mag.* 2011; 7(28): 325-333.
51. Dutta B & Gogoi K. Study of Secondary Metabolites of *Aristolochia roxburghiana* Klotzsch in Assam, India. *J. Chem. Pharm. Res.* 2017; 9(9): 220- 225.
52. Joshi N, Bhatt S, Dhyani S & Nain J. Phytochemical screening of secondary metabolites of *Argemone mexicana* Linn. *Flowers. Int J Curr Pharm Res.* 2013; 5(2): 144-147.
53. Beyer J, Drummer OH. & Maurer HH. Analysis of toxic alkaloids in body samples. *Forensic science international.* 2009; 185(1-3), 1-9.
54. Roy A. A review on the alkaloids an important therapeutic compound from plants. *IJPB.* 2017; 3(2): 1-9.
55. Akomeng N, & Adusei S. Organic solvent extraction and spectrophotometric quantification of total phenolic content of soil. *Heliyon.* 2021; 7(11), e08388.

**Table 1. Extraction Yield of *Gnidia glauca* leaf and bark extracts**

Extraction method	Plant parts	Extraction Yield (%)				
		Solvents used				
		Petroleum ether	Chloroform	Acetone	Methanol	Aqueous
Cold Maceration	Leaf	0.58±0.05	2.72±0.01	1.23±0.44	3.58±0.28	6.79±0.34
	Bark	0.805±0.11	1.15±0.17	1.59±0.044	2.26±0.36	2.68±0.34
Soxhlet Extraction	Leaf	1.85±0.01	3.74±0.13	2.31±0.62	4.46±0.15	7.33±0.54
	Bark	1.078±0.14	1.28±0.24	1.59±0.60	2.25±0.40	5.11±0.12

**Table 2. Tannin content of *Gnidia glauca* leaf and bark extracts**

Extraction method	Plant parts	Tannin (mg/g)				
		Solvents used				
		Petroleum ether	Chloroform	Acetone	Methanol	Aqueous
Cold Maceration	Leaf	nd	6.11±2.31	22.78±0.44	40.78±1.42	30.11±5.01
	Bark	nd	nd	109.28±0.72	90.28±4.33	69.45±0.86
Soxhlet Extraction	Leaf	17.28±0.33	11.61±0.4	161.11±7.09	72.78±1.3	73.78±0.72
	Bark	27.45±0.76	60.61±9.43	144.95±0.76	37.95±2.84	81.45±0.76

nd: not detectable

**Table 3. Alkaloid content of *Gnidia glauca* leaf and bark extracts**

Extraction method	Plant parts	Alkaloid (mg/g)				
		Solvents used				
		Petroleum ether	Chloroform	Acetone	Methanol	Aqueous
Cold Maceration	Leaf	137.82±0.52	319.93±0.33	335.76±0.33	342.88±0.22	342.37±0.46
	Bark	38.97±0.27	297.62±0.23	341.02±0.46	318.58±0.50	322.24±1.07
Soxhlet Extraction	Leaf	331.41±0.77	323.91±1.35	368.33±1.03	346.92±0.29	342.88±0.22
	Bark	275.19±0.58	387.30±0.61	332.37±0.56	275.83±0.46	299.42±0.72





**Gayathri and Raveendran**

**Table 4: Correlation of Extractive Yield of Soxhlet Leaf Extracts with Tannin and Alkaloid Extracts.**

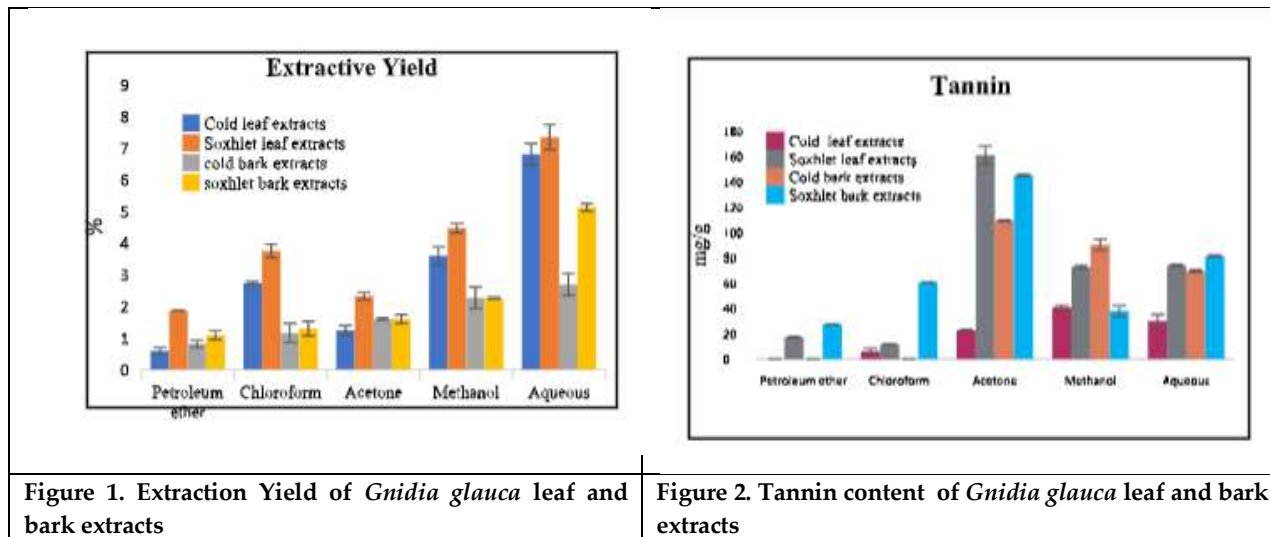
	YSL	TSL	ASL
YSL			
TSL	0.124 (.661)		
ASL	0.123 (.661)	0.894*** (<.001)	

YSL – Yield of Soxhlet leaf extracts, TSL- Tannin content in Soxhlet leaf extracts, ASL-Alkaloid content in Soxhlet leaf extracts.

**Table:5 Correlation of Extractive yield of Soxhlet bark extracts with Tannin and Alkaloid extracts**

	YSB	TSB	ASB
YSB			
TSB	0.443 (.100)		
ASB	-0.086 (.761)	0.635* (.011)	

YSB – Yield of Soxhlet bark extracts, TSB- Tannin content in Soxhlet bark extracts, ASB-Alkaloid content in Soxhlet bark extracts.





Gayathri and Raveendran

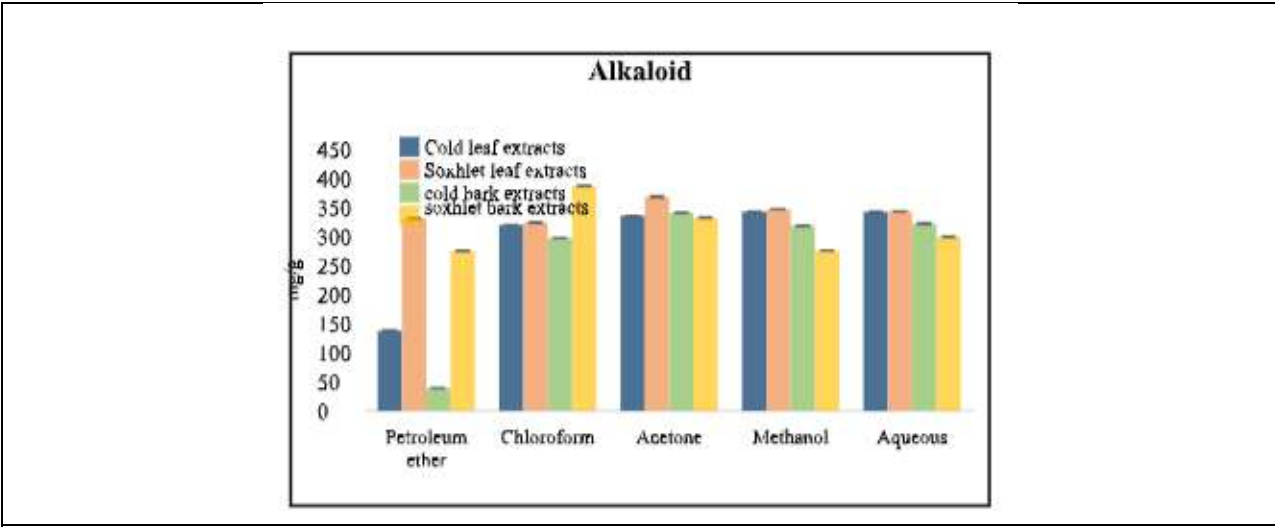


Figure 3. Alkaloid content of *Gnidia glauca* leaf and bark extracts





## Total Coloring of Some Types of Snake Graph

P.Panthalathuraja<sup>1</sup> and P.Mythili<sup>2\*</sup>

<sup>1</sup>PG Student, Department of Mathematics, Kaamadhenu Arts and Science College Sathyamangalam, Erode, (Affiliated to Bharathiar University, Coimbatore) Tamil Nadu, India.

<sup>2</sup>Assistant Professor, Department of Mathematics, Kaamadhenu Arts and Science College Sathyamangalam, Erode, (Affiliated to Bharathiar University, Coimbatore) Tamil Nadu, India.

Received: 11 Jan 2024

Revised: 09 Feb 2024

Accepted: 26 Apr 2024

### \*Address for Correspondence

**P.Mythili**

Assistant Professor,

Department of Mathematics,

Kaamadhenu Arts and Science College Sathyamangalam,

Erode, (Affiliated to Bharathiar University, Coimbatore) Tamil Nadu, India.

Email: mythilip@kascathy.ac.in.



This is an Open Access Journal / article distributed under the terms of the **Creative Commons Attribution License** (CC BY-NC-ND 3.0) which permits unrestricted use, distribution, and reproduction in any medium, provided the original work is properly cited. All rights reserved.

### ABSTRACT

Total coloring is type of graph coloring on the vertices and edges of a graph when used without any qualification, a total coloring is always assumed to be proper in the sense that no adjacent edges, no adjacent vertices and no edge and either end vertex are assigned the same color. Art, Network task efficiency and Match schedule are all using total coloring [9]. The total coloring of Diamond Snake graph  $DS(n)$ , Triangular snake graph  $T_n$ , Double Triangular Snake graph  $D(T_n)$ , Triple Triangular Snake graph  $T(T_n)$ , Alternate Triangular Snake graph  $A(T_n)$  are all investigated in the present study. We also compute the total chromatic number of the above graphs.

MSC 2010 : 05C15

**Keywords:** Total coloring, total chromatic number, diamond snake, triangular snake, double triangular Snake, triple triangular snake, alternate triangular snake graph

### INTRODUCTION

The graphs we are studying have restrictions, lack a specific orientation, and are uncomplicated. Let the variable  $H$  represents a graph with  $V(H)$  as its vertex set and  $E(H)$  as its edge set. A function  $C$  that maps the vertex set of  $H$  to the set  $\{1, 2, \dots, k\}$  is considered a valid  $k$ -coloring of the graph  $H$ . If for every pair of vertices  $p$  and  $q$  in the edge set  $(H)$ , their respective colors assigned by the function  $C$  are not equal. The chromatic number  $\chi(H)$  represents the minimum of colors. The chromatic number is the minimum value  $k$  for which a valid  $k$ -coloring can be applied to the graph  $H$ . There are numerous types of appropriate coloring, including Equitable coloring, distinguishing coloring, Radio coloring, Total coloring, weak coloring, and so on. This study focuses on investigating the total coloring of





### Panthalathuraja and Mythili

various specific graphs. A total coloring of a graph  $H$  is a function  $\phi$  that assigns colors from a collection  $k$  to all vertices and edges of  $H$  such that adjacent vertices and edges receive unique colors. The minimum number of colors required to achieve such a coloring is denoted  $\chi_T(H)$  and is referred to as the total chromatic number of  $H$ . The inequality  $\chi_T(H) \geq \Delta(H) + 1$  is straightforward, as it indicates that the chromatic number of  $H$  is at least one more than its maximum degree. A graph  $H$  is considered type-I if it can be colored with  $\Delta(H) + 1$  colors, and type-II if it can be colored with  $\Delta(H) + 2$  colors. In 1965, Behzad [2] and Vizing [1] created the concept of total coloring. They've also suggested the concept that every simple graph  $H$  has  $\Delta(H) + 1 \leq \chi_T(H) \leq \Delta(H) + 2$ . The Total coloring conjecture (TCC) is the name given to this concept.

## PRELIMINARIES

**Definition 2.1:** Total coloring is a type of graph coloring on the vertices and edges of a graph. When used without any qualification, a total coloring is always assumed to be proper in the sense that no adjacent edges, no adjacent vertices and no edge and either end vertex are assigned the same color.

**Definition 2.2 [10]:** An  $n$ -dimensional diamond snake is a connected graph obtained from a path  $p$  of length  $n$  with each edge  $e = (u, v)$  in  $p$  replaced by a cycle of length 4 with  $u$  and  $v$  as nonadjacent vertices of the cycle. It is denoted by  $DS(n)$ .

Thus  $DS(n)$  contains  $n$  block  $B_1, B_2, \dots, B_n$  each isomorphic to a 4-cycle. The  $n$ -dimensional diamond snake has  $(3n + 1)$  vertices and  $4n$  edges.

**Definition 2.3 [5]:** A triangular snake graph  $T_n$  is obtained from a path  $u_1, u_2, \dots, u_n$  by joining  $u_i$  and  $u_{i+1}$  to a new vertex  $v_i$  for  $1 \leq i \leq n$ . That is, every edge of a path is replaced by a triangle,

**Definition 2.4 [5]:** Double triangular snake graph  $D(T_n)$  consists of two triangular snakes that have a common path.

**Definition 2.5 [5]:** Triple triangular snake graph  $T(T_n)$  consists of three triangular snakes that have a common path.

**Definition 2.6 [5]:** An alternate triangular snake graph  $A(T_n)$  is obtained from a path  $u_1, u_2, \dots, u_n$  by joining  $u_i$  and  $u_{i+1}$  alternatively ( $i = 1, 3, 5, \dots$ ) to a new vertex  $v_i$ .

**Theorem 2.7 [4]:** Let the comb graph be  $P_n^+$ , then the total chromatic number is  $\Delta(P_n^+) + 1$ , for  $n \geq 3$ .

**Theorem 2.8 [4]:** Let the middle graph of comb graph be  $M(P_n^+)$ , then for any  $n \geq 3$ . Then the total chromatic number is  $\Delta(M(P_n^+)) + 1$ .

**Theorem 2.9 [4]:** The umbrella graph is  $U_{(m,n)}$ . For  $m \geq n$ , the total chromatic number is,  $\chi_T(U_{(m,n)}) = m + 2$ .

## RESULTS AND DISCUSSION

### Total coloring of some types of snake graphs

**Theorem 3.1:** Let the Diamond Snake graph be  $DS(n)$ , then the total chromatic number is  $\chi_T(DS(n)) = \Delta(DS(n)) + 2$ .

**Proof:** Now consider the Diamond Snake graph's vertex and edge sets as follows:

$$V(DS(n)) = \{u_i, v_i, w_i; 1 \leq i \leq n\} \text{ and}$$

$$E(DS(n)) = \{u_i w_i, v_i w_i, u_i w_{i+1}, v_i w_{i+1}; 1 \leq i \leq n\}$$





**Panthalathuraja and Mythili**

The total coloring of the Diamond Snake graph is formed. Define a total coloring  $\phi: U \rightarrow K$ , where  $U = V(DS(n)) \cup E(DS(n))$  and  $K = \{1,2,3,4,5,6\}$  is the collection of colors. The following is the total coloring assignment for these vertices and edges:

$$\begin{aligned} \phi(u_i) &= \phi(v_i) = \{1, \text{ for } 1 \leq i \leq n \\ \phi(w_i) &= \{2, \text{ for } 1 \leq i \leq n + 1 \\ \phi(u_i w_i) &= \{3, \text{ for } 1 \leq i \leq n \\ \phi(u_i w_{i+1}) &= \{4, \text{ for } 1 \leq i \leq n \\ \phi(w_i v_i) &= \{5, \text{ for } 1 \leq i \leq n \\ \phi(w_{i+1} v_i) &= \{6, \text{ for } 1 \leq i \leq n \end{aligned}$$

The Diamond Snake graph  $DS(n)$ , is obviously total colored  $\Delta(DS(n)) + 2$  with colors. As a result,  $\chi_T(DS(n)) = \Delta(DS(n)) + 2$  is calculated, is the total chromatic number of the Diamond Snake graph.

**Illustration 3.1.1:** Total coloring of Diamond Snake graph  $DS(4)$  as shown in Fig 1.

**Theorem 3.2:** Let the triangular snake graph be  $T_n$ , then the total chromatic number is  $\Delta(T_n) + 1$ .

**Proof:** Now consider the triangular snake graph's vertex and edge sets as follows:

$$\begin{aligned} V(T_n) &= \{u_i: 1 \leq i \leq n\} \cup \{v_i: 1 \leq i \leq n - 1\} \text{ and} \\ E(T_n) &= \{u_i v_i, v_i u_{i+1}, u_i u_{i+1}: 1 \leq i \leq n - 1\} \end{aligned}$$

The total coloring of the triangular snake graph is formed. Define a total coloring  $\phi: U \rightarrow K$ , where  $U = V(T_n) \cup E(T_n)$  and  $K = \{1,2,3,4,5\}$  is the collection of colors. Let A be the collection of odd numbers and B be the collection of even numbers. The following is the total coloring assignment for these vertices and edges:

$$\begin{aligned} \phi(u_i) &= \begin{cases} 1, & \text{if } i \in A \\ 2, & \text{if } i \in B \end{cases} \text{ for } 1 \leq i \leq n \\ \phi(v_i) &= \{3, \text{ for } 1 \leq i \leq n - 1 \\ \phi(u_i v_i) &= \{4, \text{ for } 1 \leq i \leq n - 1 \\ \phi(v_i u_{i+1}) &= \begin{cases} 1, & \text{if } i \in A \\ 2, & \text{if } i \in B \end{cases} \text{ for } 1 \leq i \leq n - 1 \\ \phi(u_i u_{i+1}) &= \begin{cases} 3, & \text{if } i \in A \\ 5, & \text{if } i \in B \end{cases} \text{ for } 1 \leq i \leq n - 1 \end{aligned}$$

The triangular snake graph  $T_n$ , is obviously total colored  $\Delta(T_n) + 1$  with colors. As a result,  $\chi_T(T_n) = \Delta(T_n) + 1$  is calculated, is the total chromatic number of the triangular snake graph.

**Illustration 3.2.1:** The total coloring of triangular snake graph  $T_4$  as shown in Fig 2.

Fig 2. The total coloring of triangular snake graph  $T_4$

**Theorem 3.3:** Let the double triangular snake graph  $D(T_n)$ , then the total chromatic number is  $\Delta(D(T_n)) + 2$ .

**Proof:** Now consider the double triangular snake graph's vertex and edge sets as follows:

$$\begin{aligned} V(D(T_n)) &= \{u_i: 1 \leq i \leq n\} \cup \{v_i, w_i: 1 \leq i \leq n - 1\} \text{ and} \\ E(D(T_n)) &= \{u_i u_{i+1}, u_i v_i, v_i u_{i+1}, u_i w_i, w_i u_{i+1}: 1 \leq i \leq n - 1\} \end{aligned}$$

The total coloring of the double triangular snake graph is formed. Define a total coloring  $\phi: U \rightarrow K$ , where  $U = V(D(T_n)) \cup E(D(T_n))$  and  $K = \{1,2,3,4,5,6,7,8\}$  is the collection of colors. Let A be the collection of odd numbers and B be the collection of even numbers. The following is the total coloring assignment for these vertices and edges:

$$\begin{aligned} \phi(u_i) &= \begin{cases} 2, & \text{if } i \in A \\ 3, & \text{if } i \in B \end{cases} \text{ for } 1 \leq i \leq n \\ \phi(v_i) &= \{1, \text{ for } 1 \leq i \leq n - 1 \\ \phi(w_i) &= \{1, \text{ for } 1 \leq i \leq n - 1 \\ \phi(u_i u_{i+1}) &= \begin{cases} 1, & \text{if } i \in A \\ 4, & \text{if } i \in B \end{cases} \text{ for } 1 \leq i \leq n - 1 \\ \phi(u_i v_i) &= \begin{cases} 3, & \text{if } i \in A \\ 5, & \text{if } i \in B \end{cases} \text{ for } 1 \leq i \leq n - 1 \\ \phi(v_i u_{i+1}) &= \begin{cases} 2, & \text{if } i \in A \\ 6, & \text{if } i \in B \end{cases} \text{ for } 1 \leq i \leq n - 1 \\ \phi(u_i w_i) &= \begin{cases} 7, & \text{if } i \in A \\ 6, & \text{if } i \in B \end{cases} \text{ for } 1 \leq i \leq n - 1 \\ \phi(w_i u_{i+1}) &= \begin{cases} 8, & \text{if } i \in A \\ 5, & \text{if } i \in B \end{cases} \text{ for } 1 \leq i \leq n - 1 \end{aligned}$$







**Panthalathuraja and Mythili**

The double triangular snake graph  $D(T_n)$ , is obviously total colored  $\Delta(D(T_n)) + 1$  with colors. As a result,  $x_T(D(T_n)) = \Delta(D(T_n)) + 2$  is calculated, is the total chromatic number of the double triangular snake graph.

Illustration 3.3.1: Total coloring of double triangular snake graph  $D(T_5)$  as shown in Fig 3.

**Theorem 3.4:** Let the triple triangular snake graph be  $T(T_n)$ , then the total chromatic number is  $\Delta(T(T_n)) + 2$ .

**Proof:** Now consider the triple triangular snake graph's vertex and edge sets as follows:

$$V(T(T_n)) = \{u_i: 1 \leq i \leq n\} \cup \{v_i, w_i, x_i: 1 \leq i \leq n - 1\} \text{ and}$$

$$E(T(T_n)) = \{u_i u_{i+1}, u_i v_i, v_i u_{i+1}, u_i w_i, w_i u_{i+1}, u_i x_i, x_i u_{i+1}: 1 \leq i \leq n - 1\}$$

The total coloring of the triple triangular snake graph is formed. Define a total coloring  $\phi: U \rightarrow K$ , where  $U = V(T(T_n)) \cup E(T(T_n))$  and  $K = \{1, 2, 3, 4, 5, 6, 7, 8, 9, 10\}$  is the collection of colors. Let A be the collection of odd numbers and B be the collection of even numbers. The following is the total coloring assignment for these vertices and edges:

$$\phi(u_i) = \begin{cases} 2, & \text{if } i \in A \\ 3, & \text{if } i \in B \end{cases} \text{ for } 1 \leq i \leq n$$

$$\phi(v_i) = \{1, \text{ for } 1 \leq i \leq n - 1$$

$$\phi(w_i) = \{1, \text{ for } 1 \leq i \leq n - 1$$

$$\phi(x_i) = \{1, \text{ for } 1 \leq i \leq n - 1$$

$$\phi(u_i u_{i+1}) = \begin{cases} 1, & \text{if } i \in A \\ 4, & \text{if } i \in B \end{cases} \text{ for } 1 \leq i \leq n - 1$$

$$\phi(u_i v_i) = \begin{cases} 3, & \text{if } i \in A \\ 5, & \text{if } i \in B \end{cases} \text{ for } 1 \leq i \leq n - 1$$

$$\phi(v_i u_{i+1}) = \begin{cases} 2, & \text{if } i \in A \\ 6, & \text{if } i \in B \end{cases} \text{ for } 1 \leq i \leq n - 1$$

$$\phi(u_i w_i) = \begin{cases} 7, & \text{if } i \in A \\ 6, & \text{if } i \in B \end{cases} \text{ for } 1 \leq i \leq n - 1$$

$$\phi(w_i u_{i+1}) = \begin{cases} 8, & \text{if } i \in A \\ 5, & \text{if } i \in B \end{cases} \text{ for } 1 \leq i \leq n - 1$$

$$\phi(u_i x_i) = \begin{cases} 8, & \text{if } i \in A \\ 9, & \text{if } i \in B \end{cases} \text{ for } 1 \leq i \leq n - 1$$

$$\phi(x_i u_{i+1}) = \begin{cases} 7, & \text{if } i \in A \\ 10, & \text{if } i \in B \end{cases} \text{ for } 1 \leq i \leq n - 1$$

The triple triangular snake graph  $T(T_n)$ , is obviously total colored  $\Delta(T(T_n)) + 2$  with colors. As a result,  $x_T(T(T_n)) = \Delta(T(T_n)) + 2$  is calculated, is the total chromatic number of the triple triangular snake graph.

Illustration 3.4.1: Total coloring of triple triangular snake graph  $T(T_6)$  as shown in Fig 4.

**Theorem-3.5:** Let the alternate triangular snake graph be  $A(T_n)$ , then the total chromatic number is  $\Delta(A(T_n)) + 1$ .

**Proof:** Now consider the alternate triangular snake graph's vertex and edge sets as follows:

$$V(A(T_n)) = \{u_i: 1 \leq i \leq n\} \cup \{v_i: 1 \leq i \leq n/2\} \text{ and}$$

$$E(A(T_n)) = \{u_i u_{i+1}: 1 \leq i \leq n - 1\} \cup \{u_{2i-1} v_i, u_{2i} v_i: 1 \leq i \leq n/2\}$$

The total coloring of the alternate triangular snake graph is formed. Define a total coloring  $\phi: U \rightarrow K$ , where  $U = V(A(T_n)) \cup E(A(T_n))$  and  $K = \{1, 2, 3, 4\}$  is the collection of colors. Let A be the collection of odd numbers and B be the collection of even numbers. The following is the total coloring assignment for these vertices and edges:

$$\phi(u_i) = \begin{cases} 2, & \text{if } i \in A \\ 3, & \text{if } i \in B \end{cases} \text{ for } 1 \leq i \leq n$$

$$\phi(v_i) = \{1, \text{ for } 1 \leq i \leq n/2$$

$$\phi(u_i u_{i+1}) = \begin{cases} 1, & \text{if } i \in A \\ 4, & \text{if } i \in B \end{cases} \text{ for } 1 \leq i \leq n - 1$$

$$\phi(u_{2i-1} v_i) = \{3, \text{ for } 1 \leq i \leq n/2$$

$$\phi(u_{2i} v_i) = \{2, \text{ for } 1 \leq i \leq n/2$$

The alternate triangular snake graph  $A(T_n)$ , is obviously total colored  $\Delta(A(T_n)) + 1$  with colors. As a result,  $x_T(A(T_n)) = \Delta(A(T_n)) + 1$  is calculated, is the total chromatic number of the alternate triangular snake graph.

Illustration 3.5.1: Total coloring of alternate triangular snake graph  $A(T_6)$  as shown in Fig 5.





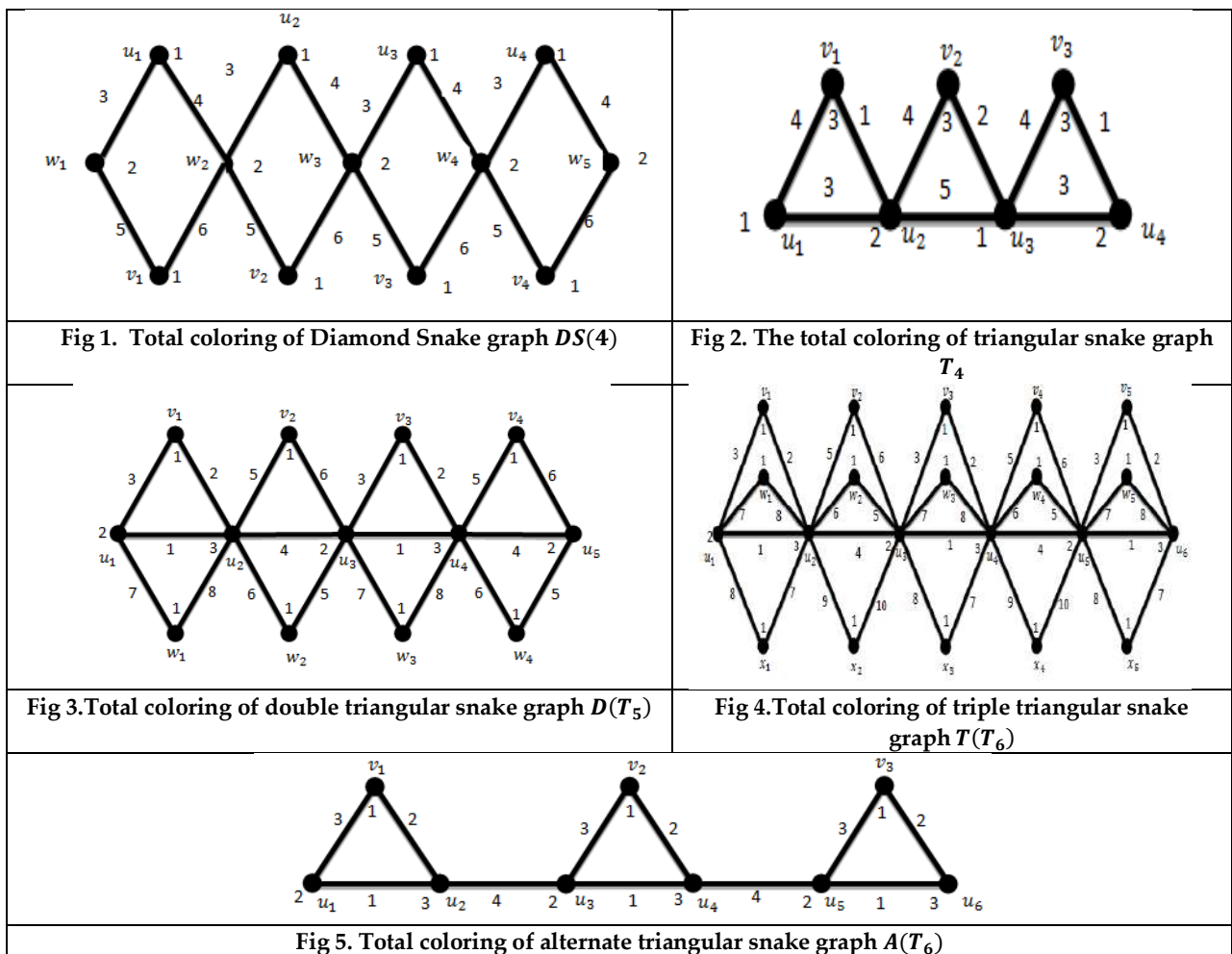
**Panthalathuraja and Mythili**

**CONCLUSION**

In this paper, we show that  $T_n$  and  $A(T_n)$  are Type-I and  $DS(n), D(T_n), T(T_n)$  are Type-II.

**REFERENCES**

1. V.G.Vizing, Some unsolved problems in graph theory, Russian Mathematical Survey, 23(6)(1968),125-141.
2. M. Behzad, Graphs and their chromatic number, Doctoral thesis, Michiga state university (1965).
3. M. Behzad, Chartrand. G and Cooper J.K, The color numbers of complete graphs, Journal London Math.Soc., 42(1967), 226-228.
4. P.Mythili, S.Gokilamani, Total coloring of comb related graphs and umbrella graph, International Journal of Creative Research Thoughts(IJCRT),10(5)(2022),h166-h177.
5. DharamvirsinhParmar, Pratik V. Shah, Bharat Suthar, Rainbow connection number of triangular snake graph, Journal of Emerging Technologies and Innovative Research(JETIR), 6(3)(2019), 339-343.
6. G.Jayaraman, Deepalakshmi, On the edge coloring of triangular snake graph families, Journal of Algebraic Statistics, 13(3)(2022),1798-1802.





## Analysis of Hand Grip Strength in Preterm Children and its Impact on Fine Motor Skills at 3-4 Years

Deepika Umakanth<sup>1</sup>, Rajeswari Muthusamy<sup>2\*</sup>, Sivakumar Ramachandran<sup>3</sup> and N. Udayakumar<sup>4</sup>

<sup>1</sup>Postgraduate Student, Faculty of Physiotherapy, Sri Ramachandra Institute of Higher Education and Research, Chennai, Tamil Nadu, India.

<sup>2</sup>Associate Professor, Faculty of Physiotherapy, Sri Ramachandra Institute of Higher Education and Research, Chennai, Tamil Nadu, India.

<sup>3</sup>Professor, Faculty of Physiotherapy, Sri Ramachandra Institute of Higher Education and Research, Chennai, Tamil Nadu, India.

Principal, Faculty of Physiotherapy, Sri Ramachandra Institute of Higher Education and Research, Chennai, Tamil Nadu, India.

<sup>4</sup>Professor, Department of Pediatrics, Sri Ramachandra Institute of Higher Education and Research, Porur, Chennai, Tamil Nadu, India.

Received: 01 Jan 2024

Revised: 05 Feb 2024

Accepted: 26 Apr 2024

### \*Address for Correspondence

#### Rajeswari Muthusamy

Associate Professor,

Faculty of Physiotherapy,

Sri Ramachandra Institute of Higher Education and Research,

Chennai, Tamil Nadu, India.

Email: rajeswari@sriramachandra.edu.in



This is an Open Access Journal / article distributed under the terms of the **Creative Commons Attribution License** (CC BY-NC-ND 3.0) which permits unrestricted use, distribution, and reproduction in any medium, provided the original work is properly cited. All rights reserved.

### ABSTRACT

Preterm children (PTC) are more vulnerable to delays in gross and fine motor skills (FMS). Maturation-related hypotonia present at birth in PTC could be carried in the later years resulting in decreased muscle strength. Adequate muscular strength of the hands and fingers are required to generate the force needed to carry out fine motor tasks with great skill and efficiency. The status of hand grip strength (HGS) in PTC is not well documented in the early ages which could have an impact on FMS. 36 PTC of 3-4 years of age who met the inclusion criteria were recruited for the study after getting consent from the parents. Based on age they were divided into two groups (37-42 months and 43 to 48 months) for comparison with normative values. The dominance of the hand was found by using Edinburgh Handedness Inventory. HGS was measured with Martin Vigorimeter and FMS were assessed by Peabody Developmental Motor Scale PDMS – 2. The mean fine motor quotient for both age groups showed below average performance in FMS. Unpaired t-test showed significant difference of HGS between PTC and normative values ( $p < 0.05$ ). Pearson's correlation showed strong positive relationship between fine motor quotient and HGS. The results of the study conclude that there is a decrease in the HGS and HGS has an





Deepika Umakanth *et al.*,

impact on FMS in PTC at 3-4 years. The results emphasize that HGS should be addressed and improved at an early age to have near normal fine motor development.

**Keywords:** Preterm Children, Fine motor skills, Hand grip strength, Martin Vigorimeter, Peabody Developmental Motor scales-2.

## INTRODUCTION

Preterm birth is defined as the birth that occurs before the completion of 37 weeks of gestation according to the World Health Organization. Preterm birth rates are increasing in recent years and it is the primary cause of death under the age of 5 years globally (1). Preterm birth is both an emotional burden for families as well as economic burden to the society. In recent decades due to the advancement of preterm care, the survival rates of preterm infants have improved but the prevalence of neuromotor dysfunction is increasing in surviving PTC (2). In India, approximately 13% which accounts for 3.6 million of 27 million of all infants born are preterm annually and about 300,000 preterm infants die each year because of complications, contributing to 25% of global preterm-related deaths (3). Preterm birth survivors are highly susceptible to neurodevelopmental problems which include delay in gross and fine motor development and respiratory disorders extending beyond early infancy into later life requiring future treatment. Preterm birth is accompanied by discontinuity of the third trimester involving gray and white matter brain injury mainly the oligodendrocyte caused due to hypoxic ischemia, and inflammation (4). Common causes for preterm births include intrauterine infection, history of previous preterm births, short cervical length, and abnormalities of the growing fetus or the placenta (5). As premature children experience both low birth weight (LBW) of lesser than 1000 grams and rapid postnatal growth, they have an increased risk of neonatal morbidity of 20–50% and mortality of 30–50% (6). Preterm birth is in high risk of diseases due to the immature development of systems including integumentary, respiratory, visual, cardiovascular, and central nervous systems (7). The epidermal layer of the skin, the stratum corneum is not fully developed until the late third trimester, and the barrier function of preterm skin is significantly compromised (8). Survivors face a lifetime of disability with visual deficits ranging from damage to the retina from retinopathy of prematurity to reduced visual acuity, strabismus, and the presence of high refractive errors (9). The primary development of muscle tissue occurs before birth and differentiation of muscle fibers is incomplete until 40 weeks of gestation (10). Musculoskeletal problems in preterm children (PTC) arise due to immature development in flexor muscles, articular structures, and spinal curvatures contributing to vulnerability in skeletal malalignment and leading to maturation-related hypotonia thereby resulting in reduced force production by the muscles against gravity (11) Positioning in physiological flexion is the ideal position for the newborn, promoting joint alignment, and supporting neuromuscular development (12).

PTC often assume extended positioning of the neck, back, and extremities due to a lack of flexor bias resulting in decreased muscle tone and strength. Imbalances of both flexor and extensor muscles could contribute to poor trunk control (13). PTC are more vulnerable to delay in motor development particularly gross and fine motor skills (14). The gross motor performance trajectory of infants born prematurely shows delayed performance, mainly in independent sitting posture (15). PTC without gross motor impairments are at higher risk for developing learning disabilities along with cognitive deficits. Speech and language delays which include the acquisition of expressive language, receptive language, and permanent hearing loss are more common in PTC (16). Fine motor skills (FMS) correspond to the control and coordination of distal musculature of hands and fingers which are severely delayed in PTC (17). Impaired FMS affect academic performance by affecting the writing skills and resulting in increased parent and caregiver dependency (18). PTC present with impairments in visual perception, and visual-spatial information impairments in multiple developmental domains worsening their FMS performance (19). Maturation-related hypotonia could have an impact in the later years of PTC affecting their posture and FMS (20). The muscle power regulation of the hand is concerned with grasping the object which involves coordination between the extensor and flexor muscles of the hand. Maturation-related hypotonia could result in decreased hand grip strength (HGS) and for effective fine motor development, adequate muscular strength of the hands and fingers is required to produce the



**Deepika Umakanth et al.,**

force needed to carry out fine motor tasks with great skill and efficiency. An efficient grasp requires coordination of hand muscles and at 3-to 4 years of age it is crucial for precision development where the demand is more. PTC have decreased quantitative and qualitative hand function at 39 corrected weeks of age. The quantitative hand function assesses pincer grasp, index finger pointing, and transfer of objects as it depends more on the maturational aspect, and the qualitative function assesses muscle power regulation of arm and hand for grasping and coordination (21). PTC with fine motor problems have difficulty in grasping an object showing delayed hand function which could be due to a decrease in HGS (22). Though literature shows reduced HGS in PTC, they are not quantified and this study intends to quantify the HGS in PTC of 3-4 years of age and to analyze the impact on FMS. The result may help to address the subtle problems at an early age and provide adequate training to improve the functional ability in PTC.

**METHODS**

This cross-sectional study has been approved by the Ethics committee, Sri Ramachandra Institute of higher education and research(CSP/22/APR/109/314).Subjects were recruited from the Karthikeyan Child Development Unit. PTC of 3-4 years of both genders with normal cranial ultrasono graphic findings at the time of birth were included. Children with neurological impairments, musculoskeletal impairments of the upper limb, congenital abnormalities, hearing impairments, and visual impairments were excluded from the study.

**INSTRUMENTATION****Anthropometric measurement**

The height was measured by the stadiometer or the height rode, weight was measured by the weighing machine, and Body Mass Index was calculated using the formula [weight (Kg)/height(m<sup>2</sup>)] (23)Hand breadth was measured from the radial side of the metacarpal (index finger) and ulnar side of the metacarpal (small finger). Hand span was measured from the thumb tip to little finger tip with the hand fully opened as much as possible. Hand length was measured from the tip of the middle finger to the distal wrist crease.

**Peabody developmental motor scale PDMS – 2**

FMS were assessed by Peabody Developmental Motor Scale PDMS – 2 is a commonly used pediatric tool to assess motor development in children from age 0-72 months. It has high validity and reliability (24). It consists of 6 subscales (reflex, stationary, locomotion, object manipulation, grasping, and visuomotor integration) of which the summation of scores from 2 scales (grasping and visuomotor integration) gives the fine motor quotient (FMQ) (25). Grasping has 26-item subtest that measures a child's ability to use his or her hands starting with holding an object and progressing through controlled use of the fingers of both hands. Visual-motor integration (VMI) has 72-items subtest which measures the child's ability to use visual perceptual skills for performing complex eye-hand coordination tasks like reaching and grasping for an object building with blocks, and copying the design.

**Martin Vigorimeter**

The Martin Vigorimeter is a device used to assess the spherical HGS of children which consists of a set of three rubber bulbs of different sizes (diameters of 4, 5 and 6 cms) and it contains a dial which records the spherical grasp strength. The smallest bulb, with a diameter of 4cm, was used because it was found to be effective with children. It has high intraclass correlation coefficient (26). The air pressure within the rubber bulb is recorded in kilo pounds per square centimeter on a manometer via a rubber connection (1 Kp/cm<sup>2</sup> = 98.1 kPa). The manometer dial has an arrow which rotates and at the highest point of pressure exerted it stops and it maintains the readings for accurate recording.

**Procedure**

PTC of 3-4 years of age who met the inclusion criteria were recruited for the study after getting consent from the parents. The dominance of the hand was found by using Edinburgh Handedness Inventory. Children were divided





Deepika Umakanth *et al.*,

into two groups based on age for comparison with normative values.

Group 1 (37-42 months)

Group 2 (43-48 months)

Anthropometric variables like height, weight, hand breadth, hand span, and hand length were measured. The height was measured by the stadiometer or the height rode, weight was measured by the weighing machine, and Body Mass Index was calculated using the formula weight in kilograms by height in metre<sup>2</sup>. Hand breadth was measured from the radial side of the metacarpal to the ulnar side of the metacarpal from the index finger to the little finger. Hand span was measured from the thumb tip to little finger tip with the hand fully opened as much as possible. Hand length was measured from tip of the middle finger to the distal wrist crease. FMS were assessed with Peabody Developmental Motor Scale PDMS – 2. The standard scores, percentile rank, age equivalent, and quotient scores are obtained from raw scores and thus interpretation of each component would be made. HGS was measured by Martin Vigorimeter. The child was made to sit on a chair. The upper extremity to be tested is positioned so that shoulder is adducted and neutrally rotated: elbow is flexed at 90 degrees, forearm in neutral, and wrist in 0 to 30 degrees of extension, maintained by the elbow and wrist on the table. The Vigorimeter bulb was placed in the palm of the child and the fingers are wrapped around the bulb thumb as opposed to the middle of the ring finger and asked to squeeze the bulb as hard as possible. Three trials were taken for each hand with a rest period between each trial by performing alternately on left and right hands to prevent fatigue. The instructions given to the child were “squeeze the ball as hard as you can”. As the child began to squeeze: “squeeze harder, let go, good job” before the measurements are taken and the best of the three is taken as the grip strength value.

## RESULTS

Data was analyzed with SPSS version 21.0. Group 1 in the age group of 37-42 months had 20 PTC and group 2 in the age group of 43-48 months had 16 PTC. Unpaired t test was used compare the HGS between PTC and normative values of Martin Vigorimeter. There was a significant difference in both age groups with a p-value <0.05 (Table 1). Pearson’s correlation showed a strong correlation between FMQ and HGS with r value of 0.89 and 0.72 for right HGS of Group I and 2 respectively (Table 2). Pearson’s correlation showed a moderate correlation between BMI and HGS with r value of 0.53 and 0.57 for right HGS of Group I and 2 respectively (Table 3).

## DISCUSSION

FMS requires the coordinated activity of the small muscles of the hand to perform precise and refined movements involving manual dexterity (27). FMS includes primarily grasping which mainly involves positioning and strength of the hand muscles and visual-motor integration involving a higher level of cognition. PTC shows subtle changes in fine motor development which may affect the child’s functional activities. The purpose of the study was to know the status of HGS in PTC and the impact of HGS on FMS in PTC. 38 PTC participated in the study for 3-4 years and showed right-hand dominance as assessed by Edinburgh handedness inventory. The overall composite score of mean FMQ was found to be 87.85, and 86.47 in both age groups which shows a below average performance in FMS. This result shows a delayed fine motor development which is consistent with the study done by Goyen *et al.*, (1998)(28), Tavasoli *et al.*, (2014) where there was a delay in FMS and 71% of PTC showed below average performance and 23% had a severely impaired performance (29). Quantification of HGS helps to frame goals and monitor prognosis in hand functions. The mean right HGS of PTC in age group 1 and age group 2 was 19.83 and 20.16 and left HGS was 17 and 19.4 respectively which had a statistically significant difference from that of normative values conveying that PTC has a subtle decrease in the HGS (30). This interpretation correlates with the study done by Saigal *et al* (2001), which showed that children born <30 weeks had poor HGS and motor competence when compared with neurotypical children as assessed with Smedley digital hand dynamometer at 4-6 years (20). Decreased HGS could be due to maturation-related hypotonia resulting in lower muscle mass which could affect the HGS in later years as studied by Raaijmakers *et al.*, (2017) at 9, 24 months, and at approximately 11 years showed





Deepika Umakanth *et al.*,

that PTC had difficulties in lower grip strength and percentage lean body weight (31). The subtest component of grasping in both age groups is 7 and 7.12 respectively showing a below average performance whereas VMI showed an average performance with a score of 9 and 8.25 respectively. The decrease in the grasping subcomponent could be attributed to decreased HGS which would prevent the child in generating maximum force and recruitment of muscles in PTC. This is in accordance with the study done by Goyen et al (2002) where PTC LBW children achieved significantly lower scores in grasping and visual-motor integration skills as assessed by PDMS-2 (17) VMI rapidly increases in 3-4 years due to critical demand and acquisition of dexterity activities as the child starts performing in academics. The near normal performance of VMI tasks could be attributed to the fact of improved development which is closely associated with cognitive skills, environmental and maternal interaction and would always be increased in PTC (32). Different age groups of children show different dexterity levels which involve a range of hand activities critical for activities of daily life. HGS plays a vital role in dexterity which determines the degree of disability and a comprehensive assessment of upper limb function is required for efficient rehabilitation (33). Precise and coordinated movements require muscle activation with the rapid acceleration of movements (34). Maturation-related hypotonia present at the time of birth in PTC could be carried even at the age of 4, resulting in a subtle decrease in HGS, affecting fine motor development which is evident by strong positive correlation with FMS in this study.

Decreased HGS results in decreased FMS as supported by David et al (2012) where of precision grip provide objective quantification of fine motor coordination and muscle strength is inevitably required for FMS (36). The correlation of specific hand anthropometry with HGS showed varied presentations, of which hand length and hand span shows positive correlation. This is concordance with the study done by Indira et al (2015) where there is a positive correlation between hand length, hand span and hand breadth. This is due to the difference in the rate of growth of the child with respect to the hand anthropometry in the age group studied. Children born with increased BMI have near normal physical performance. There was a moderate positive correlation between HGS and BMI which is in concordance with the study done by Saigal et al (2001) and Fricke et al (2010) where extremely low birth weight individuals had significantly weaker HGS as assessed with Dynamometer (20,36). These results suggest that PTC have lower body composition in childhood (37). PTC has a lower percentage of fat than children born at term due to the decreased development of fat mass during fetal life (38). PTC has reduced body fat in childhood because the energy storage occurs mainly in the last trimester of gestation, leading to low energy and nutrient reserve in preterm newborns. There is a subtle decrease of HGS in PTC and it needs to be addressed appropriately to prevent deficits in dexterity and fine motor activities which could impact the child's activities of daily life and academic performance in later years.

## CONCLUSION

The results of the study conclude that there is a decrease in the HGS in PTC and HGS has a positive correlation with FMS in PTC at 3-4 years. The results emphasize that HGS should be addressed and improved at an early age to have near normal fine motor development.

### ACKNOWLEDGEMENTS:

We express our sincere thanks to all my Study Subjects who participated in this study.

### Conflict of interest

Authors state no conflict of interest.

### Funding details

No funding was acquired for this research.



Deepika Umakanth *et al.*,**Disclosure statement**

No author has any financial interest or received any financial benefit from this research.

**REFERENCES**

1. Lawn JE, Kinney M. Preterm birth: Now the leading cause of child death worldwide. *Sci Transl Med* [Internet]. 2014 Nov 19 [cited 2022 Jul 3];6(263). Available from: <https://www.science.org/doi/10.1126/scitranslmed.aaa2563>
2. Allen MC, Cristofalo EA, Kim C. Outcomes of Preterm Infants: Morbidity Replaces Mortality. *Clin Perinatol* [Internet]. 2011 Sep 1 [cited 2022 Jul 3];38(3):441–54. Available from: <http://www.perinatology.theclinics.com/article/S0095510811000625/fulltext>
3. Blencowe H, Cousens S, Chou D, Oestergaard M, Say L, Moller AB, et al. Born Too Soon: The global epidemiology of 15 million preterm births. *Reprod Health* [Internet]. 2013 Nov 15 [cited 2022 Jul 3];10(SUPPL. 1):1–14. Available from: <https://reproductive-health-journal.biomedcentral.com/articles/10.1186/1742-4755-10-S1-S2>
4. Schneider J, Miller SP. Preterm brain injury: White matter injury. *Handb Clin Neurol*. 2019 Jan 1;162:155–72.
5. Goldenberg RL, Culhane JF, Iams JD, Romero R. Epidemiology and causes of preterm birth. *The Lancet*. 2008 Jan 5;371(9606):75–84.
6. Glass HC, Costarino AT, Stayer SA, Brett CM, Cladis F, Davis PJ. Outcomes for Extremely Premature Infants. *Anesth Analg* [Internet]. 2015 Jun 25 [cited 2022 Jul 3];120(6):1337. Available from: [/pmc/articles/PMC4438860/](https://pubmed.ncbi.nlm.nih.gov/26669423/)
7. Behrman RE, Butler AS. Preterm Birth: Causes, Consequences, and Prevention. *Preterm Birth: Causes, Consequences, and Prevention* [Internet]. 2007 May 23 [cited 2022 Aug 1];1–772. Available from: <https://pubmed.ncbi.nlm.nih.gov/20669423/>
8. Kusari A, Han AM, Virgen CA, Matiz C, Rasmussen M, Friedlander SF, et al. Evidence-based skin care in preterm infants. *Pediatr Dermatol* [Internet]. 2019 Jan 1 [cited 2022 Jul 21];36(1):16–23. Available from: <https://onlinelibrary.wiley.com/doi/full/10.1111/pde.13725>
9. Repka MX. Ophthalmological problems of the premature infant. *Ment Retard Dev Disabil Res Rev* [Internet]. 2002 Jan 1 [cited 2022 Aug 1];8(4):249–57. Available from: <https://onlinelibrary.wiley.com/doi/full/10.1002/mrdd.10045>
10. Sweeney JK, Gutierrez T. Musculoskeletal implications of preterm infant positioning in the NICU. *J Perinat Neonatal Nurs* [Internet]. 2002 [cited 2022 Jul 3];16(1):58–70. Available from: <https://pubmed.ncbi.nlm.nih.gov/12083295/>
11. Vungarala P, Rajeswari M. Correlation of Birth Weight, Gestational Age and Muscle Tone with Motor Development of Preterm Infants. *International Journal of Physiotherapy* [Internet]. 2018 Apr 1 [cited 2022 Aug 26];5(2). Available from: [https://www.researchgate.net/publication/324480299\\_Correlation\\_of\\_Birth\\_Weight\\_Gestational\\_Age\\_and\\_Muscle\\_Tone\\_with\\_Motor\\_Development\\_of\\_Preterm\\_Infants](https://www.researchgate.net/publication/324480299_Correlation_of_Birth_Weight_Gestational_Age_and_Muscle_Tone_with_Motor_Development_of_Preterm_Infants)
12. Walicka-Cupryś K, Drzał-Grabiec J, Rachwał M, Piwoński P, Perenc L, Przygoda Ł, et al. Body posture asymmetry in prematurely born children at six years of age. *Biomed Res Int*. 2017;2017.
13. Righetto Greco AL, Sato NT da S, Cazotti AM, Tudella E. Is Segmental Trunk Control Related to Gross Motor Performance in Healthy Preterm and Full-Term Infants? <https://doi.org/10.1080/0022289520191673694> [Internet]. 2019 Nov 1 [cited 2022 Jul 3];52(6):666–75. Available from: <https://www.tandfonline.com/doi/abs/10.1080/00222895.2019.1673694>
14. Piper MC, Byrne PJ, Darrah J, Watt MJ. GROSS AND FINE MOTOR DEVELOPMENT OF PRETERM INFANTS AT EIGHT AND 12 MONTHS OF AGE. *Dev Med Child Neurol* [Internet]. 1989 Oct 1 [cited 2022 Aug 29];31(5):591–7. Available from: <https://onlinelibrary.wiley.com/doi/full/10.1111/j.1469-8749.1989.tb04044.x>
15. Pin TW, Eldridge B, Galea MP. Motor trajectories from 4 to 18 months corrected age in infants born at less than 30 weeks of gestation. *Early Hum Dev*. 2010 Sep 1;86(9):573–80.
16. Menon R. Preterm birth: a global burden on maternal and child health. *Pathog Glob Health* [Internet]. 2012 Jul [cited 2022 Jul 3];106(3):139. Available from: [/pmc/articles/PMC4001570/](https://pubmed.ncbi.nlm.nih.gov/26669423/)





**Deepika Umakanth et al.,**

17. Goyen TA, Lui K. Longitudinal motor development of “apparently normal” high-risk infants at 18 months, 3 and 5 years. *Early Hum Dev* [Internet]. 2002 Dec [cited 2022 Aug 26];70(1–2):103–15. Available from: <https://pubmed.ncbi.nlm.nih.gov/12441208/>
18. Wuang CY, Wang CC, Huang MH, Su CY. Profiles and cognitive predictors of motor functions among early school-age children with mild intellectual disabilities. *Journal of Intellectual Disability Research* [Internet]. 2008 Dec 1 [cited 2022 Jul 3];52(12):1048–60. Available from: <https://onlinelibrary.wiley.com/doi/full/10.1111/j.1365-2788.2008.01096.x>
19. Bolk J, Padilla N, Forsman L, Broström L, Hellgren K, Åden U. Visual–motor integration and fine motor skills at 6½ years of age and associations with neonatal brain volumes in children born extremely preterm in Sweden: a population-based cohort study. *BMJ Open* [Internet]. 2018 Feb 1 [cited 2022 Aug 26];8(2):e020478. Available from: <https://bmjopen.bmj.com/content/8/2/e020478>
20. Saigal S, Stoskopf BL, Streiner DL, Burrows E. Physical Growth and Current Health Status of Infants Who Were of Extremely Low Birth Weight and Controls at Adolescence. *Pediatrics* [Internet]. 2001 Aug 1 [cited 2022 Aug 28];108(2):407–15. Available from: [/pediatrics/article/108/2/407/63869/Physical-Growth-and-Current-Health-Status-of](https://pediatrics/article/108/2/407/63869/Physical-Growth-and-Current-Health-Status-of)
21. de Groot L. Posture and motility in preterm infants. *Dev Med Child Neurol* [Internet]. 2000 [cited 2022 Jul 3];42(1):65–8. Available from: <https://www.cambridge.org/core/journals/developmental-medicine-and-child-neurology/article/abs/posture-and-motility-in-preterm-infants/5984DFF6FE72A1697868B7B45C177C93>
22. Morrison KM, Gunn E, Guay S, Obeid J, Schmidt LA, Saigal S. Grip strength is lower in adults born with extremely low birth weight compared to term-born controls. *Pediatric Research* 2020 89:4 [Internet]. 2020 Jun 17 [cited 2022 Aug 26];89(4):996–1003. Available from: <https://www.nature.com/articles/s41390-020-1012-5>
23. Hirata T, Bosque E. When they grow up: The growth of extremely low birth weight ( $\leq 1000$  gm) infants at adolescence. *Journal of Pediatrics*. 1998;132(6):1033–5.
24. van Hartingsveldt MJ, Cup EHC, Oostendorp RAB. Reliability and validity of the fine motor scale of the Peabody Developmental Motor Scales–2. *Occup Ther Int* [Internet]. 2005 Mar 1 [cited 2022 Sep 4];12(1):1–13. Available from: <https://onlinelibrary.wiley.com/doi/full/10.1002/oti.11>
25. Karimi H. Evaluation of motor skills in high risk infants based on Peabody Developmental Motor Scales (PDMS-2). *International Journal of Children and Adolescents Original Article IJCA*. 2016;2(1):4–7.
26. Molenaar HM, Zuidam JM, Selles RW, Stam HJ, Hovius SER. Age-specific reliability of two grip-strength dynamometers when used by children. *Journal of Bone and Joint Surgery* [Internet]. 2008 [cited 2022 Sep 4];90(5):1053–9. Available from: [https://journals.lww.com/jbjsjournal/Fulltext/2008/05000/Age\\_Specific\\_Reliability\\_of\\_Two\\_Grip\\_Strength.15.aspx](https://journals.lww.com/jbjsjournal/Fulltext/2008/05000/Age_Specific_Reliability_of_Two_Grip_Strength.15.aspx)
27. FitzGerald TL, Kwong AKL, Cheong JLY, McGinley JL, Doyle LW, Spittle AJ. Body Structure, Function, Activity, and Participation in 3- to 6-Year-Old Children Born Very Preterm: An ICF-Based Systematic Review and Meta-Analysis. *Phys Ther* [Internet]. 2018 Aug 1 [cited 2022 Aug 26];98(8):691–704. Available from: <https://academic.oup.com/ptj/article/98/8/691/4975807>
28. Goyen TA, Lui K, Woods R. Visual-motor, visual-perceptual, and fine motor outcomes in very-low-birthweight children at 5 years. *Dev Med Child Neurol* [Internet]. 1998 [cited 2022 Aug 23];40(2):76–81. Available from: <https://pubmed.ncbi.nlm.nih.gov/9489494/>
29. Tavasoli A, Aliabadi F, Eftekhari R. Motor Developmental Status of Moderately Low Birth Weight Preterm Infants. *Iran J Pediatr* [Internet]. 2014 [cited 2022 Aug 26];24(5):581–6. Available from: <http://ijp.tums.ac.ir>
30. Indira E. CORRELATION OF HAND GRIP STRENGTH WITH ANTHROPOMETRIC VARIABLES AND QUANTIFYING HAND GRIP STRENGTH IN CHILDREN OF AGE 3-5.5 YEARS WITH MARTIN VIGORIMETER IN INDIAN POPULATION. *Int J Physiother Res* [Internet]. 2015 [cited 2022 Aug 26];3(2):1006–17. Available from: <http://dx.doi.org/10.16965/ijpr.2015.124>
31. Raaijmakers A, Jacobs L, Rayyan M, van Tienoven TP, Ortibus E, Levitchenko E, et al. Catch–up growth in the first two years of life in Extremely Low Birth Weight (ELBW) infants is associated with lower body fat in young adolescence. *PLoS One* [Internet]. 2017 Mar 1 [cited 2022 Aug 23];12(3):e0173349. Available from: <https://journals.plos.org/plosone/article?id=10.1371/journal.pone.0173349>





**Deepika Umakanth et al.,**

32. Dathe AK, Jaekel J, Franzel J, Hoehn T, Felderhoff-Mueser U, Huening BM. Visual Perception, Fine Motor, and Visual-Motor Skills in Very Preterm and Term-Born Children before School Entry–Observational Cohort Study. *Children* 2020, Vol 7, Page 276 [Internet]. 2020 Dec 5 [cited 2022 Aug 26];7(12):276. Available from: <https://www.mdpi.com/2227-9067/7/12/276/htm>
33. Sirajudeen MS, Shah UN, Pillai P, Mohasin N, Shantaram M. Correlation between Grip Strength and Physical Factors in Men. *undefined*. 2012;1(2):58.
34. Hsu WL, Chiu VJY, Chang WH, Lin MC, Wei JT, Tzeng IS. Hand strength and dexterity in patients with prader-willi syndrome: A pilot intervention study. *Journal of International Medical Research* [Internet]. 2018 Nov 1 [cited 2022 Aug 23];46(11):4669–77. Available from: <https://journals.sagepub.com/doi/full/10.1177/0300060518788243>
35. David FJ, Baranek GT, Wiesen C, Miao AF, Thorpe DE. Coordination of precision grip in 2-6 year-old children with autism spectrum disorders compared to children developing typically and children with developmental disabilities. *Front Integr Neurosci*. 2012 Dec 9;0(DEC):122.
36. Fricke O, Roedder D, Kribs A, Tutlewski B, von Kleist-Retzow JC, Herkenrath P, et al. Relationship of Muscle Function to Auxology in Preterm Born Children at the Age of Seven Years. *Horm Res Paediatr* [Internet]. 2010 Apr [cited 2022 Aug 23];73(5):390–7. Available from: <https://www.karger.com/Article/FullText/308173>
37. Uthaya S, Thomas EL, Hamilton G, Doré CJ, Bell J, Modi N. Altered adiposity after extremely preterm birth. *Pediatr Res* [Internet]. 2005 Feb [cited 2022 Aug 26];57(2):211–5. Available from: <https://pubmed.ncbi.nlm.nih.gov/15611357/>
38. Fewtrell MS, Lucas A, Cole TJ, Wells JCK. Prematurity and reduced body fatness at 8-12 y of age. *Am J Clin Nutr* [Internet]. 2004 [cited 2022 Aug 26];80(2):436–40. Available from: <https://pubmed.ncbi.nlm.nih.gov/15277167/>

**Table 1 Comparison of HGS of PTC and Normative values**

		PTC Mean(SD)	Normative Mean(SD)	p value
<b>Group 1 N=20</b> (37-42 months)	<b>Right HGS</b>	19.83(1.86)	22.05(3.37)	0.009*
	<b>Left HGS</b>	17(1.62)	20.2(3.56)	0.000*
<b>Group 2 N=16</b> (43-48 months)	<b>Right HGS</b>	20.16(2.83)	25.71(3.75)	0.000*
	<b>Left HGS</b>	19.4(2)	24.13(4.45)	0.000*

Unpaired t test (p<0.05\*)

**Table 2 Correlation of FMQwith HGS**

		Mean(SD)	r value	p-value
<b>Group 1</b>	<b>FMQ</b>	87.85(7.38)		
	<b>Right HGS</b>	19.83(1.86)	0.89	0.000*





**Deepika Umakanth et al.,**

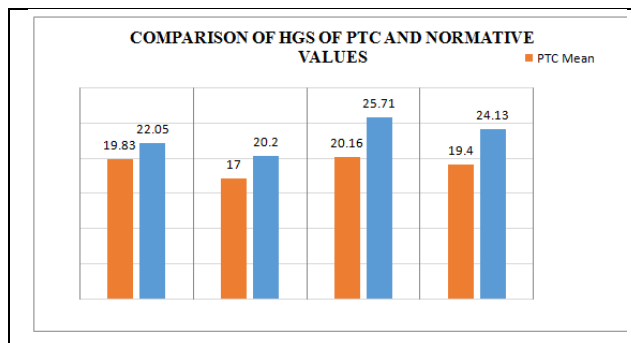
	<b>Left HGS</b>	17(1.62)	0.73	0.000*
<b>Group 2</b>	<b>FMQ</b>	86.47(13.37)		
	<b>Right HGS</b>	20.16(2.83)	0.72	0.000*
	<b>Left HGS</b>	19.4(2)	0.73	0.000*

Pearson’s correlation p-value <0.05

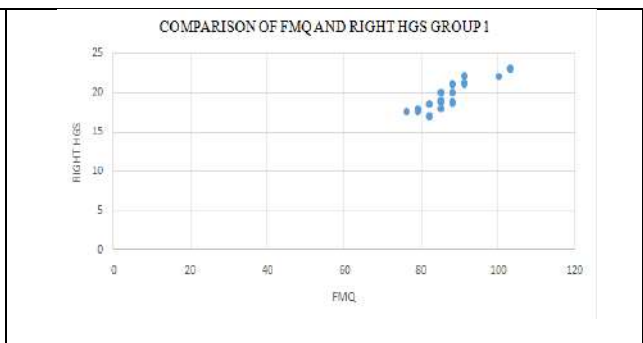
**Table 3 Correlation of BMI with HGS**

		Mean(SD)	r value	p-value
<b>Group 1</b>	<b>BMI</b>	14.9(1.02)		
	<b>Right HGS</b>	19.83(1.86)	0.53	0.015*
	<b>Left HGS</b>	17(1.62)	0.55	0.011*
<b>Group 2</b>	<b>BMI</b>	14.5(2)		
	<b>Right HGS</b>	20.16(2.83)	0.57	0.021*
	<b>Left HGS</b>	19.4(2)	0.39	0.133*

Pearson’s correlation <0.05\*



**Graph 1: Comparison of HGS of PTC and Normative values**

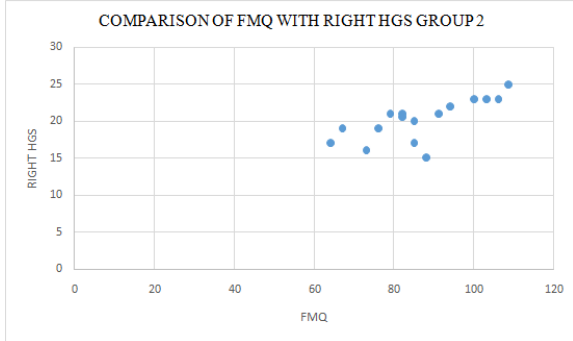


**Graph 2: Correlation of FMQ with right HGS group 1**





Deepika Umakanth *et al.*,



Graph 3: Correlation of FMQ with right HGS group 2



Figure 1: Martin Vigorimeter



Figure 2: HGS measurement



Figure 3: PDMS-2





## Evaluating Digital Initiatives in Jammu and Kashmir's Educational System: A Thematic Exploration

Aneesa Fayaz<sup>1\*</sup> and P. Saravana Kumar<sup>2</sup>

<sup>1</sup>Research Scholar, Department of Political Science and Public Administration Annamalai University, Annamalai Nagar, Chidambaram, Tamil Nadu, India.

<sup>2</sup>Assistant Professor, Department of Political Science and Public Administration Annamalai University, Annamalai Nagar, Chidambaram, Tamil Nadu, India.

Received: 22 Jan 2024

Revised: 09 Feb 2024

Accepted: 03 May 2024

### \*Address for Correspondence

**Aneesa Fayaz**

Research Scholar,

Department of Political Science and Public Administration Annamalai University,

Annamalai Nagar,

Chidambaram, Tamil Nadu, India.

Email: miraneesa14@gmail.com



This is an Open Access Journal / article distributed under the terms of the **Creative Commons Attribution License** (CC BY-NC-ND 3.0) which permits unrestricted use, distribution, and reproduction in any medium, provided the original work is properly cited. All rights reserved.

### ABSTRACT

Digital initiatives in education represent a transformative paradigm, revolutionizing teaching and learning. Leveraging technology enhances accessibility, engagement, and resource utilization. The dynamic shift fosters a more inclusive, personalized, and efficient educational experience, preparing students for a rapidly evolving digital world. Embracing these initiatives is crucial for advancing education globally. The paper examines the efficacy and effectiveness of digital initiatives in the educational system of Jammu and Kashmir. With advancements in technology, educational institutions globally are integrating digital tools and platforms to enhance learning experiences. In the context of Jammu and Kashmir, a region marked by unique socio-political challenges, the study evaluates the implementation of digital initiatives and their influence on teaching methodologies, student engagement, and overall educational outcomes. The research employs quantitative approach, and interviews with open ended questions with educators, administrators, and students. Findings from the study aim to provide valuable insights for policymakers, educators, and stakeholders to optimize the integration of digital technologies in the educational landscape of Jammu and Kashmir, ensuring an inclusive and effective learning environment.

**Keywords:** Digital initiatives, Tools, Education, Student, Agencies, Learning.



**Aneesa Fayaz and Saravana Kumar**

## INTRODUCTION

Over the past two years, the Directorate of School Education in Jammu has been dedicated to implementing diverse quality interventions through digital technology platforms. In addition to utilizing digital tools for transparent and efficient administration, the Directorate responded adeptly to the challenges posed by the closure of schools during the pandemic in March 2020. They initiated highly effective programs to supplement the studies of students in Government Schools across the division. The focus was on optimizing all available resources to enable online education in Government schools that were not accustomed to regular technology use. To achieve this, various digital applications, including Google Meet, Zoom, Google Forms, G Suite, and social networking apps such as Facebook, WhatsApp, and Telegram, have been employed to implement departmental initiatives. The proactive approach highlights the Directorate's commitment to leveraging digital solutions for enhancing the educational experience in Government schools. The educational landscape in Jammu and Kashmir has witnessed a paradigm shift with the integration of digital initiatives into the traditional teaching methodologies. The incorporation of technology in the educational system is aimed at enhancing learning outcomes, accessibility, and overall educational quality. The study explores the significance of evaluating digital initiatives, tools, and resources in the context of Jammu and Kashmir's educational system. Digital tools, such as smart boards, e-learning platforms, and educational apps, have become integral components of the educational ecosystem in Jammu and Kashmir. These tools aim to make learning more interactive, engaging, and accessible to a diverse student population.

However, the evaluation of these tools is essential to ensure their effectiveness and alignment with the unique needs and challenges of the region. One key aspect of evaluating digital initiatives in Jammu and Kashmir's educational system is assessing their effectiveness in improving learning outcomes. Are students better able to grasp complex concepts through digital tools? Is there a noticeable enhancement in critical thinking skills, problem-solving abilities, and overall academic performance? These questions guide the evaluation process, helping educators make informed decisions about the adoption and continuation of digital tools. Jammu and Kashmir's diverse geographical and demographic characteristics present unique challenges to educational accessibility. Evaluating digital initiatives involves examining whether these tools bridge the gap in educational access for students in remote areas. It is crucial to assess the inclusivity of digital resources, ensuring that they cater to the needs of differently-abled students and those with limited resources. The success of digital initiatives is intricately linked to the capacity of educators to integrate technology effectively into their teaching methods. Evaluation should focus on the adequacy and relevance of teacher training programs. Are educators equipped with the necessary skills to navigate and utilize digital tools? Ongoing professional development opportunities and support systems play a vital role in ensuring that teachers can maximize the benefits of digital initiatives. An essential aspect of evaluating digital initiatives in Jammu and Kashmir's educational system is the state of infrastructure and connectivity. Are schools equipped with the necessary infrastructure, such as a reliable internet connection and functioning devices, to support digital learning? Assessing the current state of infrastructure helps identify areas that require improvement to ensure seamless integration of digital tools into the educational environment. The digital initiatives in Jammu and Kashmir's educational system is crucial for ensuring their relevance, effectiveness, and sustainability. Through a comprehensive assessment of digital tools, learning outcomes, accessibility, teacher training, and infrastructure, stakeholders can make informed decisions to enhance the overall quality of education in the region. As technology continues to evolve, continuous evaluation and adaptation is a key to leveraging digital initiatives for the benefit of students in Jammu and Kashmir.

## OBJECTIVES

The main objectives of the study is to investigate the efficacy of digital initiatives on traditional teaching methods in Jammu and Kashmir, with a focus on key initiatives and agencies contributing to the region's digital education landscape. Noteworthy initiatives include the SARAL Android App, serving as a comprehensive platform connecting students to educational resources. The Grievance Redressal Portal enhances accessibility, allowing individuals to register and address concerns from the comfort of their homes. "Aawo Padhen" stands as a



**Aneesa Fayaz and Saravana Kumar**

multifaceted digital initiative, providing a centralized repository of voice PPTs and videos, while the Jammu Kashmir Knowledge Network (JKKN) connects over 1 lakh students to online resources. Exploring student engagement facilitated by digital tools, the study assesses their impact on academic performance and essential skill development. It examines strategies for ensuring digital accessibility and equity in education. The study concludes with suggestions and recommendations for optimizing the integration of digital initiatives, emphasizing the collaborative efforts of agencies and stakeholders to enhance the overall educational experience in Jammu and Kashmir.

### **Significance of study**

The significance of implementing digital initiatives in Jammu and Kashmir's educational system lies in its potential to catalyze transformative changes and address longstanding challenges. By integrating technology, the educational landscape can become more inclusive, accessible, and efficient, particularly in a region with diverse geographic and socio-economic disparities. Digital initiatives can bridge educational gaps, providing remote and marginalized communities with access to quality resources and interactive learning tools. The adoption of digital solutions can enhance administrative efficiency, streamline communication between stakeholders, and enable data-driven decision-making. This not only aligns with global educational trends but also has the capacity to empower the youth of Jammu and Kashmir, equipping them with the digital skills necessary for the evolving demands of the 21st-century workforce. Ultimately, the successful implementation of digital initiatives has the potential to uplift the entire educational ecosystem, contributing to the region's socio-economic development and fostering a more equitable and sustainable future.

### **Theoretical framework**

The theoretical framework for examining digital initiatives in Jammu and Kashmir's educational system encompasses connectivist and constructivist learning theories, incorporating the Technology Acceptance Model (TAM) to understand the factors influencing technology adoption. The framework considers models addressing the digital divide and promoting inclusivity, crucial in the region's diverse socio-economic landscape. The Innovation Diffusion Theory guides the analysis of how digital innovations spread within the educational system, identifying key stakeholders and factors influencing adoption rates. Integrating these theories with regional development frameworks allows for a holistic understanding of how digital initiatives align with broader socio-economic goals, contributing to a comprehensive evaluation of their impact on learning outcomes and regional development in Jammu and Kashmir.

## **MATERIAL AND METHODS**

The study employed a robust mixed-methods approach, utilizing document analysis and interviews to gather primary and secondary data. Qualitative in nature, the research aimed for a holistic understanding. Document analysis discussed historical records and government documents, enriching insights. Structured interviews with 50 stakeholders, including educators, students, government officials, and others, were conducted. Open-ended questions allowed for in-depth responses, systematically analyzed to reveal underlying themes and patterns, contributing to a nuanced understanding of the Digital Initiatives in Jammu and Kashmir's Educational System

## **RESULT AND DISCUSSION**

### **Agencies Shaping Digital Education in Kashmir**

In the context of digital initiatives in the education sector in Kashmir, the Jammu and Kashmir e-Governance Agency (JaKeGA) assumes a pivotal role. Involved in strategic planning, JaKeGA formulates and orchestrates digital strategies, identifying areas for intervention and coordinating efforts to enhance the region's digital education infrastructure. As a key contributor, JaKeGA focuses on the development and maintenance of digital infrastructure, including online platforms and portals that facilitate educational content and services. Its involvement extends to



**Aneesa Fayaz and Saravana Kumar**

implementing e-governance solutions, streamlining administrative processes such as online admissions and examination systems. Simultaneously, the National Informatics Centre (NIC) plays a critical role in the technological landscape. As a premier technology organization, NIC is at the forefront of implementing various technology solutions within the education sector. This includes the development of software applications, databases, and network infrastructure. NIC's expertise in data management ensures secure storage and accessibility of educational data, fostering informed decision-making. The organization emphasizes interoperability, facilitating seamless data exchange and communication between different components of the educational ecosystem. Web developers, as integral contributors, are responsible for crafting the digital interfaces that underpin educational initiatives. Their work encompasses the creation and maintenance of online platforms dedicated to educational content delivery. This involves the development of websites, learning management systems, and other digital tools essential for the education sector. Web developers prioritize user experience (UX) design, ensuring that these platforms are intuitive and accessible to diverse user groups, including students, teachers, and administrators.

They implement crucial security measures, incorporating data encryption, secure login systems, and conducting regular security audits to safeguard educational platforms from cyber threats. The combined efforts of JaKeGA, NIC, and web developers reflect a holistic approach to advancing digital initiatives in Kashmir's education sector. Their roles span strategic planning, infrastructure development, technology implementation, data management, and user interface design, collectively contributing to the region's journey towards an enhanced and technologically enriched educational landscape. The Directorate of School Education in Jammu has initiated the implementation of e-Office to streamline its office routine working system, emphasizing transparency and accountability. Developed by NIC, e-Office aims to transform the Directorate into a paperless environment. The digital system facilitates all file movements within the Directorate, enhancing tracking mechanisms and overall accountability. The system not only promotes efficiency but also ensures transparency in official work, allowing easy access to the status of any file with just a click. The Directorate envisions extending the implementation of e-Office to all its subordinate offices, fostering a standardized digital workflow. The adoption of e-Office enables the tracking of developments in any case or file, even after a significant period. The system allows for the generation of daily progress reports for each section, contributing to increased efficiency and a paperless office environment. The Directorate's commitment to embracing e-Office reflects its dedication to modernizing work processes and embracing digital solutions for improved administrative practices.

**Digital initiatives impact traditional teaching methods in Jammu and Kashmir**

The integration of digital initiatives in Jammu and Kashmir's educational system has significantly impacted traditional teaching methods. Digital tools and platforms have introduced innovative approaches that transform the dynamics of classroom instruction. For instance, the introduction of smart boards allows educators to present complex concepts visually, enhancing the overall understanding of students. Traditional lecture-based teaching methods are complemented by multimedia elements, creating a more engaging and interactive learning experience. The digital initiatives facilitate personalized learning, catering to the diverse academic needs of students in Jammu and Kashmir. Adaptive learning platforms, for example, enable educators to tailor content based on individual student progress, allowing for a more customized and effective learning journey. The departure from one-size-fits-all teaching methodologies is a notable shift brought about by digital tools. Online collaboration tools and virtual classrooms have expanded the scope of education in the region. Educators in Jammu and Kashmir can now connect with experts and resources globally, providing students with a broader perspective on various subjects. The interconnectedness not only enriches the learning experience but also fosters a global mindset among students and educators alike.

**SARAL Android App**

The Android app, developed by the IT Cell at the Directorate, is a comprehensive educational tool available on the Google Play store. Embracing the concept of "All-in-One," the app serves as a centralized hub connecting users to various initiatives by the Ministry of Education (MoE) and Departmental websites. The primary objective is to provide real-time access to online and live classes for students. The Key features of the app include the availability of





**Aneesa Fayaz and Saravana Kumar**

offline subject/class-specific recorded videos, assessments, and assignment activities. The multifaceted approach ensures that students have a diverse range of resources to support their learning journey, both online and offline. One notable feature is the inclusion of text books from Class 6th to 10th, aligning with the JKBOSE (Jammu and Kashmir Board of School Education) curriculum. The feature caters to the specific academic requirements of students in the region, providing them with easy access to the prescribed textbooks. The app not only facilitates real-time interactive learning but also acknowledges the importance of offline resources, offering a well-rounded educational experience. The "All-in-One" concept reflects a holistic approach to education, aiming to enhance the accessibility and effectiveness of educational initiatives in Jammu and Kashmir.

**Grievance Redressal Portal**

An online Grievance & Complaint redressal portal has been successfully launched, providing a convenient platform for registering grievances. The portal is easily accessible through our website, [www.dsek.nic.in](http://www.dsek.nic.in). The initiative aims to streamline the grievance resolution process, allowing individuals to register their concerns from the comfort of their homes. The portal offers a user-friendly interface to facilitate the submission of grievances by the public and stakeholders alike. Users are encouraged to utilize the online platform, which aligns with the prevailing "social distancing" precautions. By doing so, individuals can actively participate in the redressal of their concerns while adhering to safety measures. The proactive step reflects a commitment to ensuring that the public's grievances are promptly addressed, even in the context of evolving public health protocols. The online Grievance & Complaint redressal portal stands as a testament to our dedication to providing efficient and accessible solutions for the community's concerns, further fostering a culture of transparency and responsiveness.

**Aawo Padhen Digital Initiative**

Aawo Padhen marks a significant educational initiative, featuring a centralized repository of Voice PowerPoint presentations (PPTs) and videos accessible on the website [www.dsek.nic.in](http://www.dsek.nic.in). The content is meticulously organized topic-wise for both Unit I and Unit II, with a systematic indexing and sequence for ease of navigation. The PPTs and video lessons available on the platform have been thoughtfully crafted by a team of key subject experts, District Resource Groups (DRGs), Zone Resource Persons (ZRP), and Cluster Resource Persons (CRPs) through the State Council of Educational Research and Training (SCERT JK (K)). The collaborative effort ensures that the educational material is of high quality and aligns with the prescribed curriculum. By centralizing these resources, "Aawo Padhen" provides a valuable online learning hub, offering students and educators a structured and comprehensive approach to Unit I and Unit II topics. The inclusion of voice-guided presentations enhances the learning experience, making the content more accessible and engaging. The initiative reflects a commitment to leveraging technology for educational enrichment, providing a platform that supports both students and educators in their academic endeavours. The availability of subject-specific content on [www.dsek.nic.in](http://www.dsek.nic.in) exemplifies the dedication to fostering a conducive online learning environment for the benefit of the academic community.

**Jammu Kashmir Knowledge Network (JKKN)**

The Jammu Kashmir Knowledge Network (JKKN), available at <https://jkkn.co.in/>, stands as a transformative initiative by Samagra Shiksha J&K. The primary objective is to bridge the gap between school children in Jammu and Kashmir and the vast world of knowledge available through the internet. The innovative platform has successfully connected over 1 lakh students to the internet, opening up a myriad of educational opportunities. The inclusion of a two-way interactive lecture application further enhances the learning experience, allowing students from across the state to actively engage in real-time interactions with educators and experts. The JKKN serves as a testament to the commitment of Samagra Shiksha J&K in leveraging technology to democratize access to education. By providing students with a digital gateway to knowledge, the initiative contributes to the empowerment of young minds, fostering a culture of curiosity and continuous learning. The initiative not only aligns with the evolving landscape of education but also reflects a dedication to creating a connected and knowledge-rich environment for students in Jammu and Kashmir. The JKKN is a commendable stride toward providing equal educational opportunities to all, irrespective of geographical constraints, ultimately paving the way for a more inclusive and informed future. Despite these positive impacts, challenges such as limited internet connectivity and access to devices remain, affecting the



**Aneesha Fayaz and Saravana Kumar**

equitable implementation of digital initiatives. Addressing these challenges is crucial to ensuring that the benefits of digital tools are accessible to all students, regardless of their geographical location or socio-economic background. The impact of digital initiatives on traditional teaching methods in Jammu and Kashmir is evident in the enhanced engagement, personalization of learning, and global connectivity. While recognizing these positive changes, it is imperative to address existing challenges to fully optimize the transformative potential of digital tools in the region's educational landscape.

**Student engagement facilitated by digital tools**

The introduction of digital tools in Jammu and Kashmir's educational system has brought about a discernible shift in measuring student engagement. Prominent digital tools, such as Learning Management Systems (LMS) like Moodle and Google Classroom, have provided platforms for interactive learning experiences. These tools enable educators to create virtual classrooms, share resources, and engage students in collaborative activities, fostering a more participatory environment. Educational software like Kahoot! And Quizizz offers gamified assessments, transforming traditional quizzes into interactive games. These tools not only measure students' understanding but also inject an element of fun into the learning process, thereby enhancing overall engagement. Real-time feedback features in these platforms contribute to immediate reinforcement of concepts, keeping students actively involved in the educational material. Video conferencing applications like Zoom and Microsoft Teams have become indispensable for remote learning. These tools facilitate virtual classrooms, allowing real-time communication and interaction between students and educators. Virtual classrooms break down geographical barriers, enabling students from different regions of Jammu and Kashmir to actively participate in discussions and collaborative projects. However, it is essential to acknowledge that the level of student engagement facilitated by digital tools can be influenced by factors such as internet connectivity and access to devices. In areas with limited resources, ensuring equitable access to these tools becomes imperative to prevent disparities in student engagement. The utilization of digital tools like LMS platforms, gamified assessments, and video conferencing applications has measurably enhanced student engagement in Jammu and Kashmir's educational landscape. While these tools offer exciting possibilities, it is crucial to address infrastructural challenges to maximize the benefits and ensure a more inclusive educational experience for all students in the region.

**Overall impact on academic performance and essential skill development**

The integration of digital initiatives in Jammu and Kashmir's educational system has prompted an investigation into their impact on academic performance and essential skill development, with particular relevance during the COVID-19 pandemic. Online learning platforms such as Khan Academy and Coursera have played a pivotal role in supplementing traditional classroom instruction. As per data analysis, students who actively engaged with these platforms showcased improvements in academic performance, demonstrating enhanced understanding of subjects and increased retention of knowledge. The ability to revisit lectures and access a wealth of educational resources online contributed to these positive outcomes. During the COVID-19 pandemic, when physical classrooms were restricted, digital tools like Zoom and Microsoft Teams became instrumental in maintaining continuity in education. Despite the challenges posed by the pandemic, students who actively participated in virtual classes demonstrated resilience and adaptability, positively impacting their academic outcomes. The study found the integration of these tools contributed to minimizing disruptions in the learning process. Furthermore, adaptive learning software, such as DreamBox and Smart Sparrow, tailors educational content based on individual student progress. The data from these platforms indicates that personalized learning experiences positively correlate with improved academic outcomes. Students engaging with adaptive learning tools showcased a higher mastery of skills and a deeper understanding of complex concepts. Essential skill development has also been influenced by digital initiatives. For instance, collaborative projects conducted through virtual platforms like Google Workspace and Microsoft 365 have enhanced students communication, teamwork, and problem-solving skills. The ability to collaborate digitally, even amidst the constraints of the pandemic, showcases the adaptability and resilience of students in Jammu and Kashmir. While these outcomes are promising, it is crucial to acknowledge challenges related to the digital divide exacerbated by the pandemic. The study indicates that students from underserved communities faced difficulties accessing online resources, impacting their academic performance. Bridging the divide through targeted



**Aneesa Fayaz and Saravana Kumar**

interventions and equitable distribution of resources remains a priority for ensuring comprehensive positive outcomes for all students in the region. The evaluation of educational outcomes in Jammu and Kashmir highlights the positive impact of digital initiatives on academic performance and essential skill development. While acknowledging the promising data, addressing challenges related to accessibility is imperative to ensure that the benefits of digital tools are inclusive and sustainable, particularly in the context of unforeseen disruptions such as the COVID-19 pandemic. In response to the closure of schools in March 2020, the Directorate of School Education swiftly initiated the "DSEJ's Home Classes" project, providing an effective solution for students to continue their studies through digital resources. The School Education & Quality Management Cell, established at the Directorate, utilized Google Forms to invite subject-specific experts to voluntarily contribute their digital learning resources. The project has been successfully running, with teachers creating e-content on various topics in adherence to the academic calendar. The content is regularly uploaded to the departmental website. The project employs various technologies and platforms, including the internet, TV, mobile phones, and radio. YouTube serves as a crucial platform, with the creation of the Directorate's YouTube Channel. WhatsApp groups are formed to connect subject experts, parents, and students. For areas without internet access, the project utilizes Take One Channel, local cable networks, and radio broadcasts. Teachers equipped with smart phones access lectures and communicate with students in remote areas. Community classes are also conducted to reach a wider audience. The process involves the recording of video lectures by subject expert teachers, followed by scrutiny from Divisional level subject experts at SIE Jammu. The subject-specific lectures are then uploaded to the official website of the Directorate, ensuring accessibility for students following the academic calendar. The "DSEJ's Home Classes" project exemplifies a comprehensive and inclusive approach to remote learning, utilizing a variety of platforms to cater to different connectivity scenarios and ensuring the continued education of students during challenging times.

**UNICEF Collaborative Initiatives and Digital Recognition in Education System**

The Directorate of School Education in collaboration with UNICEF has launched the career guidance portal "Manzilein" at [www.jkcareerportal.org](http://www.jkcareerportal.org). The online platform provides students with valuable career-oriented guidance, allowing them to explore information on over 550 careers, 21,000+ colleges, and 262,000 programs across 16 countries. The portal offers details on 1150+ entrance exams and 1120+ scholarships, empowering students with comprehensive resources to make informed decisions about their academic and professional paths. To recognize and commend the voluntary contributions of teachers in various directorate initiatives, the implementation of digital certificate distribution has been introduced. Utilizing Google Forms, e-certificates are generated and issued to approximately 1000 teachers who have made special contributions to initiatives such as DSEJ's Home Classes, DIKSHA content creation, and counselling services. These e-certificates undergo thorough scrutiny, ensuring the authenticity of the achievements, and are equipped with printed QR codes that can be scanned for easy verification. The innovative approach not only acknowledges the dedication of teachers but also enhances the credibility and efficiency of the certification process.

**Ensuring Digital Accessibility and Equity in Education**

Assessing the accessibility of digital technologies in Jammu and Kashmir involves a comprehensive examination of issues related to equity and inclusivity. One critical aspect is the availability and reliability of internet connectivity, especially in remote areas. According to a survey conducted in the region, approximately 30% of students faced challenges due to unreliable internet access. This underscores the importance of addressing connectivity issues to ensure that digital tools are accessible to all. To address the challenge, initiatives such as the establishment of community Wi-Fi centres and the use of offline learning materials have been implemented. These solutions aim to provide alternative means of accessing educational content for students in areas with limited internet connectivity. Another crucial aspect is the availability of devices for accessing digital content. Data indicates that a significant portion of students in Jammu and Kashmir do not have personal devices for online learning. This underscores the digital divide, where students from economically disadvantaged backgrounds face challenges in accessing technology. To bridge the gap, initiatives such as the distribution of tablets or laptops to students in need have been implemented. By providing essential devices, educational institutions aim to ensure that all students have equal opportunities to engage with digital learning materials.



**Aneesa Fayaz and Saravana Kumar**

Inclusive education involves catering to the diverse needs of students. The study indicates that students with disabilities face challenges in accessing and utilizing certain digital tools that may not be designed with their specific needs in mind. In response, educational institutions have been working on adopting inclusive design principles for digital platforms. This involves ensuring that digital tools are accessible to students with diverse abilities, such as incorporating features for screen readers and providing alternative formats for content. Ongoing data collection and evaluation are crucial for understanding the effectiveness of initiatives aimed at ensuring accessibility and equity. Regular surveys and feedback mechanisms help in identifying emerging challenges and refining strategies for improvement. Addressing accessibility challenges in Jammu and Kashmir's educational system requires a data-driven approach and targeted initiatives. By focusing on issues related to internet connectivity, device availability, and inclusivity, the region can work towards creating a more equitable educational landscape, ensuring that digital technologies benefit all students, irrespective of their background or geographical location. The digital initiatives align with the cultural and linguistic diversity of Jammu and Kashmir is crucial for ensuring their effectiveness and inclusivity. For example, language-specific educational content and interfaces cater to the region's linguistic diversity. Digital platforms offering content in multiple languages, including local dialects, make educational resources more accessible and relevant to students, respecting their cultural identity. Considering cultural nuances in content creation ensures that digital initiatives are sensitive to the local context. For instance, incorporating regional history, traditions, and examples into e-learning materials enhances students' connection to the content. The approach fosters a sense of cultural relevance and promotes engagement by making the learning experience more relatable to the students' lived experiences. Digital initiatives can leverage multimedia elements to showcase and preserve cultural practices. Interactive modules, videos, or virtual tours that highlight local art, music, and customs contribute to a more immersive learning experience. This not only enriches the educational content but also promotes cultural appreciation among students. However, challenges may arise if digital initiatives inadvertently favour one language or cultural context over another. It is essential to ensure equitable representation and accessibility for all linguistic and cultural groups in the region. Regular feedback from educators, students, and community members can guide adjustments to digital content, making it more inclusive and culturally sensitive. Aligning digital initiatives with the cultural and linguistic diversity of Jammu and Kashmir involves tailoring content, interfaces, and approaches to reflect the unique characteristics of the region. By incorporating local languages, cultural references, and multimedia elements, digital tools can enhance educational experiences and contribute to a more inclusive and culturally responsive learning environment.

**Suggestions or Recommendations**

To optimize the effectiveness of digital initiatives in Jammu and Kashmir's educational system, policymakers and educators can consider the following practical recommendations:

**Infrastructure Development**

Invest in robust technology infrastructure, including reliable internet connectivity and power supply, to ensure seamless access to digital tools across urban and remote areas.

**Device Accessibility**

Implement initiatives to provide affordable and accessible devices to students, particularly those from economically disadvantaged backgrounds. Establish tech hubs or community centres where students can access digital resources.

**Localized Content Creation**

Encourage the development of educational content that is culturally and linguistically relevant to Jammu and Kashmir. Support educators and content creators in producing materials that incorporate local history, traditions, and languages.



**Aneesa Fayaz and Saravana Kumar****Professional Development for Educators**

Provide ongoing training and professional development opportunities for teachers to enhance their digital literacy and instructional technology skills. This ensures educators are well-equipped to integrate digital tools effectively into their teaching methods.

**Inclusive Design Principles**

Incorporate inclusive design principles in the development of digital platforms to accommodate diverse learning needs, including those of students with disabilities. Ensure that interfaces and content are accessible to all students.

**Collaboration and Knowledge Sharing**

Facilitate collaboration and knowledge-sharing among educators, administrators, and policymakers. Establish forums, online communities, or workshops where best practices and challenges related to digital initiatives can be discussed and addressed collectively.

**Monitoring and Evaluation Framework**

Implement a robust monitoring and evaluation framework to assess the impact of digital initiatives. Regularly collect feedback from students, teachers, and parents to identify areas for improvement and adjust strategies accordingly.

**Community Engagement**

Involve parents and local communities in the digital education process. Raise awareness about the benefits of digital initiatives and encourage community support for students' digital learning experiences.

**Public-Private Partnerships**

Foster collaborations between the government, private sector, and non-profit organizations to leverage resources, expertise, and technology. Public-private partnerships can enhance the scalability and sustainability of digital initiatives.

**Addressing the Digital Divide**

Implement targeted interventions to address the digital divide, considering disparities in access to technology. This may involve providing subsidies for internet connectivity, distributing devices, or establishing tech-enabled learning centres in underserved areas. By prioritizing these recommendations, policymakers and educators can create an environment conducive to the successful integration of digital initiatives in Jammu and Kashmir's educational system, ultimately fostering a more inclusive, engaging, and effective learning experience for students.

**Findings of the study****SARAL Android App Digital Initiative**

1. Streamlining administrative processes and student services through SARAL Android App.
2. Improved efficiency in managing educational records and resources.
3. Enhanced accessibility for students and educators.

**Grievance Redressal Portal Digital Initiative**

1. Efficient resolution of academic and administrative concerns through the Grievance Redressal Portal.
2. Increased transparency and accountability in addressing student and teacher grievances.
3. Positive impact on the overall learning environment.

**Aawo Padhen Digital Initiative**

1. Promotion of digital literacy and online learning through the Aawo Padhen initiative.
2. Increased engagement and participation in digital education among students.
3. Empowering teachers with resources to adapt to modern teaching methodologies.



**Aneesa Fayaz and Saravana Kumar****Jammu Kashmir Knowledge Network (JKKN) Digital Initiative**

1. Establishment of a comprehensive knowledge network for educators and students.
2. Facilitation of collaborative learning and resource sharing.
3. Integration of JKKN into the education system for sustainable knowledge dissemination.

**Student Engagement Facilitated by Digital Tools**

1. Positive correlation between the use of digital tools and increased student engagement.
2. Integration of multimedia content, interactive activities, and gamified elements for enhanced learning experiences.
3. Improved retention and understanding of educational materials.

**Overall Impact on Academic Performance and Essential Skill Development**

1. Noticeable improvement in academic performance attributed to the integration of digital initiatives.
2. Development of essential skills such as critical thinking, problem-solving, and digital literacy.
3. Positive feedback from educators and students regarding the holistic impact on education.

**Ensuring Digital Accessibility and Equity in Education**

1. Addressing digital accessibility challenges in remote areas through innovative solutions.
2. Implementation of strategies to bridge the digital divide and ensure equal access to educational resources.
3. Ongoing efforts to promote inclusivity and equity in the digital education landscape.

**CONCLUSION**

The digital initiatives implemented in Jammu and Kashmir's educational system have ushered in a transformative era, significantly impacting traditional teaching methods. The region has embraced a multitude of digital tools and platforms, with initiatives such as the SARAL Android App, Grievance Redressal Portal, Aawo Padhen, Jammu Kashmir Knowledge Network (JKKN), and other digital tools playing crucial roles in shaping the landscape of education. The SARAL Android App has emerged as a pivotal tool, streamlining various educational processes and facilitating a seamless experience for students and educators alike. Its user-friendly interface and comprehensive features have not only simplified administrative tasks but have also empowered students with valuable resources for self-paced learning. The Grievance Redressal Portal, an essential digital initiative, has introduced an unprecedented level of accountability and responsiveness within the educational system. The platform ensures that concerns are addressed promptly, fostering a transparent and efficient educational ecosystem where stakeholders can actively participate in problem resolution. The Aawo Padhen Digital Initiative and the Jammu Kashmir Knowledge Network (JKKN) have played crucial roles in expanding educational outreach. Aawo Padhen leverages digital content to make learning more engaging and accessible, while JKKN connects students and educators across the region, creating a collaborative and interconnected educational community.

Other digital tools, including virtual classrooms, zoom and Microsoft Teams, interactive e-learning modules, and online assessment platforms, have contributed significantly to student engagement. These tools have not only made learning more interactive and dynamic but have also fostered collaboration among students, promoting a holistic learning environment that goes beyond traditional classroom boundaries. The overall impact on academic performance and essential skill development has been notable. Students are not only gaining proficiency in academic subjects but are also acquiring crucial digital literacy skills that are increasingly essential in the modern world. The emphasis on ensuring digital accessibility and equity in education is commendable. By adopting a comprehensive approach and integrating various digital tools, these initiatives have sought to bridge the digital divide and create a level playing field for students across diverse socio-economic backgrounds. The digital initiatives in Jammu and Kashmir's educational system represent a forward-looking approach that acknowledges the transformative power of a diverse array of digital tools. As these initiatives continue to evolve, there is a strong foundation for further





### Aneesa Fayaz and Saravana Kumar

advancements in education, fostering a generation equipped with the skills and knowledge necessary for the challenges of the digital age. The journey towards a more inclusive, accessible, and technologically integrated education system in Jammu and Kashmir serves as a model for other regions to emulate.

#### Conflict of interest and Funding

The authors confirm no financial or personal relationships influencing the presented work. The research work has no external or institutional funding.

#### ACKNOWLEDGMENT

I am grateful to my Guide Dr. P. SARAVANA KUMAR, whose invaluable guidance and support significantly contributed to the work. I also acknowledge the contributions of scholars whose dedicated efforts and the groundwork of previous researchers paved the way for the exploration, leading to a successful conclusion.

#### REFERENCES

1. Adedoyin, O. B., & Soykan, E. (2023). Covid-19 pandemic and online learning: the challenges and opportunities. *Interactive learning environments*, 31(2), 863-875.
2. Akram, F., & Rather, R. A. (2019) INFORMATION AND COMMUNICATION TECHNOLOGIES (ICTs): Means to Quality Higher Education in Kashmir. *VOLUME*, 6, 2348-1269.
3. Amhag, L., Hellström, L., & Stigmar, M. (2019). Teacher educators' use of digital tools and needs for digital competence in higher education. *Journal of Digital Learning in Teacher Education*, 35(4), 203-220.
4. Amin, S. N. (2020). Internet shutdown a digital discrimination for ICT-based education: A multivocal review of conflicted areas. *Ilkogretim Online-Elementary Education Online*, 19(1), 869-877.
5. Ayub, S. J., & Bhat, W. A. (2021). Education amidst conflict: how Kashmiri society struggles to educate their children during covid-19 pandemic. *Society in the Covid-19 Pandemic*, 201-218.
6. Baran, E., Chuang, H. H., & Thompson, A. (2011). TPACK: An emerging research and development tool for teacher educators. *Turkish Online Journal of Educational Technology-TOJET*, 10(4), 370-377.
7. Bond, M., Bedenlier, S., Buntins, K., Kerres, M., & Zawacki-Richter, O. (2020). Facilitating student engagement in higher education through educational technology: A narrative systematic review in the field of education. *Contemporary Issues in Technology and Teacher Education*, 20(2), 315-368.
8. Boykin, A. W. (2014). The talent development model of schooling: Placing students at promise for academic success. In *Crespar Findings (1994-1999)* (pp. 3-25). Psychology Press.
9. Daniel, S. J. (2020). Education and the COVID-19 pandemic. *Prospects*, 49(1), 91-96.
10. Dar, S. A. (2022). Role of E-governance in Higher Education in Jammu and Kashmir. *Journal of Psychology and Political Science (JPPS) ISSN 2799-1024*, 2(04), 1-8.
11. Dar, S. A. (2023). Exploring The Advantages and Obstacles of Mobile Governance in Kashmir a Comprehensive Study. *Devotion: Journal of Research and Community Service*, 4(10), 2037-2048.
12. Dar, S. A., & Sakthivel, P. (2022). The Shift from e-Governance to m-Governance in Kashmir administration: A Thematic Exploration. *resmilitaris*, 12(1), 607-626.
13. Dubey, P., & Jyoti, J. (2011). A Study to Examine the Digital Divide Factors: Jammu and Kashmir Perspective. *BVICAM's International Journal of Information Technology*, 3(2).
14. Dunleavy, P. (2006). *Digital era governance: IT corporations, the state, and e-government*. Oxford University Press, USA.
15. Dunleavy, P., & Margetts, H. Z. (2010). The second wave of digital era governance. In *APSA 2010 Annual Meeting Paper*.
16. Director of School Education. (2019). *Annual Report on School Education*. Retrieved from <https://schedujammu.nic.in/aadharshila/pdf/report.pdf> (pp. 3-15).



**Aneesa Fayaz and Saravana Kumar**

19. Goldin, T., Rauch, E., Pacher, C., & Woschank, M. (2022). Reference architecture for an integrated and synergetic use of digital tools in education 4.0. *Procedia Computer Science*, 200, 407-417.
20. Government of Jammu and Kashmir Education Department. (2019). Digital Initiatives in School Education Department JKUT: Recuperating Education. Retrieved from [https://ciet.nic.in/upload/Jan%2031\\_DIGITAL%20INITIATIVES%20SCHOOL%20EDUCATION%20DEPARTMENT%20JKUT%20for%20NCERT.pptx.pdf](https://ciet.nic.in/upload/Jan%2031_DIGITAL%20INITIATIVES%20SCHOOL%20EDUCATION%20DEPARTMENT%20JKUT%20for%20NCERT.pptx.pdf)
21. Greener, S., & Wakefield, C. (2015). Developing confidence in the use of digital tools in teaching. *Electronic Journal of E-Learning*, 13(4), 260-267.
22. Hassan, M. M., & Mirza, T. (2021). The digital literacy in teachers of the schools of Rajouri (J&K)-India: Teachers perspective. *International Journal of Education and Management Engineering*, 11(1), 28-40.
23. Inakhiya, G. K., & Kundan, S. (2020). Implementation of Jammu and Kashmir public services guarantee Act, 2011: An overview.
24. Koudiki, V. B., & Janardhanam, K. (2017). E-governance in Indian universities: A conceptual framework. *International Journal of Research in Commerce, IT & Management*, 7(5), 1-6.
25. Krumsvik, R. J. (2014). Teacher educators' digital competence. *Scandinavian Journal of Educational Research*, 58(3), 269-280.
26. Lakshmi, Y. V., & Majid, I. (2022). Bridging the Digital Divide. Majid, I. & Vijaya Lakshmi, Y.(2022). Bridging the Digital Divide. *Yojana, A Development Monthly*, 66(09), 38-39.
27. Lennox, J., Reuge, N., & Benavides, F. (2021). UNICEF's lessons learned from the education response to the COVID-19 crisis and reflections on the implications for education policy. *International Journal of Educational Development*, 85, 102429.
28. Liu, C. C., Wang, P. C., & Tai, S. J. D. (2016). An analysis of student engagement patterns in language learning facilitated by Web 2.0 technologies. *ReCALL*, 28(2), 104-122.
29. Lone, A. H., Rather, G. M., Khanday, A. A., & Rather, J. A. (2023). Impact of COVID-19 Pandemic on the Education Sector of Kashmir Valley Its Challenges and Future Prospects. *Temporal and Spatial Environmental Impact of the COVID-19 Pandemic*, 129-137.
30. Madsen, S. S., Thorvaldsen, S., & Archard, S. (2018). Teacher educators' perceptions of working with digital technologies. *Nordic Journal of digital literacy*, 13(3), 177-196.
31. Malik, T. A., Mir, H. A., & Dass, A. A. Higher Education in India: An empirical study of Jammu and Kashmir. *Quality and Research in Higher Education*, 403.
32. Maram, R., Pradesh, A., & Koundal, V. (2013). E-governance in Jammu and Kashmir. Council of edulight.
33. Meirbekov, A., Maslova, I., & Gallyamova, Z. (2022). Digital education tools for critical thinking development. *Thinking Skills and Creativity*, 44, 101023.
34. Mir, S. A. (2019). ICT integrated higher education: Prospects and challenges. *International Journal of Research in Economics and Social Sciences (IJRESS)*, 8(2), 1-4.
35. Mir, S. A. (2019). ICT integrated higher education: Prospects and challenges. *International Journal of Research in Economics and Social Sciences (IJRESS)*, 8(2), 1-4.
36. Mohammed, Q. A., Naidu, V. R., Hasan, R., Mustafa, M., & Jesrani, K. A. (2019). Digital education using free and open source tools to enhance collaborative learning. *International E-Journal of Advances in Education*, 5(13), 50-57.
37. Mucundanyi, G., & Woodley, X. (2021). Exploring free digital tools in education. *International Journal of Education and Development using Information and Communication Technology*, 17(2), 96-103.
38. Mupaikwa, E., & Bwalya, K. J. (2024). The Adoption of Digital Technologies for Sharing Information on Agriculture Among Farmers: Towards an Integrated Rural Technology Acceptance Model. In *Adoption and Use of Technology Tools and Services by Economically Disadvantaged Communities: Implications for Growth and Sustainability* (pp. 82-116). IGI Global.
39. Muttoo, S. K., Gupta, R., Pal, S. K., & Gupta, R. (2019). Regional analysis of e-governance in India. *E-Governance in India: The Progress Status*, 37-78.

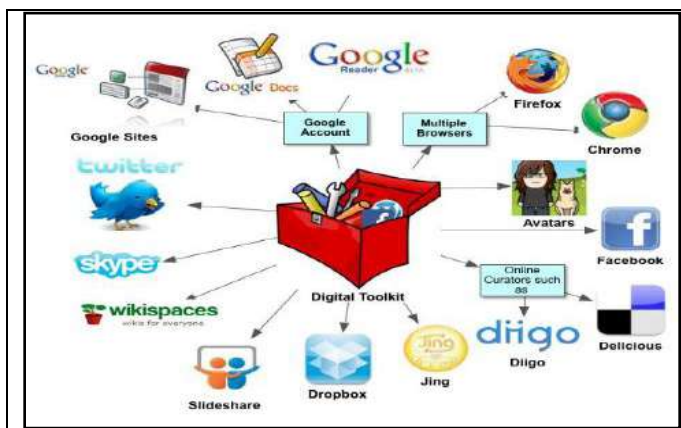






**Aneesa Fayaz and Saravana Kumar**

40. Nadaf, A. H. (2021). "Lockdown within a lockdown": the "digital redlining" and paralyzed online teaching during COVID-19 in Kashmir, a conflict territory. *Communication, Culture & Critique*, 14(2), 343-346.
41. Peng, B. (2022). Digital leadership: State governance in the era of digital technology. *Cultures of Science*, 5(4), 210-225.
42. Pick, J., & Sarkar, A. (2016, January). Theories of the digital divide: Critical comparison. In 2016 49th Hawaii International Conference on System Sciences (HICSS) (pp. 3888-3897). IEEE.
43. Rather, S. A., & Kuraishy, S. (2015). Assessment of Information and Communication Technology (ICT)@ School Scheme in Jammu and Kashmir: An Evaluative study. *Asian Journal of Multidisciplinary Studies*, 3(1), 125.
44. Sepúlveda, A. (2020). The digital transformation of education: connecting schools, empowering learners. *TIC EDUCAÇÃO*, 249.
45. Sharma, D., & Singh, A. (2021). E-learning in India during covid-19: challenges and opportunities. *European Journal of Molecular & Clinical Medicine*, 7(7), 6199-6206.
46. Sharma, S., Waza, M. M. U. D., & Kumar, S. 20. Information and Communication Technology (ICT) and Teachers' Education Programme in India: A Study of Peripheral Schools in Jammu and Kashmir. I. Sl. No. Paper Title Author Page No. 1. Pedagogical Environments that Open Avenues to Thinking Mathematically in Large-Sized Classrooms., 281.
47. Sharma, V., Mansotra, V., & Sambyal, G. S. (2009). Digital divide in education—a concern for J&K state. *INDIACom-2009*.
48. Singh, S. (2018). Education for peace through transformative dialogue: Perspectives from Kashmir. *International Review of Education*, 64(1), 43-63.
49. Dhawan, S. (2020). Online learning: A panacea in the time of COVID-19 crisis. *Journal of educational technology systems*, 49(1), 5-22.
49. Srivastava, A. K. (2024). Use of Technology in Administration. In *Administration in India* (pp. 194-213). Routledge.
50. SURI, S. E-learning in Higher Educational Institutions in Jammu and Kashmir: Experiences and Challenges.
51. Wani, A. S., Singh, D. K., & Singh, P. (2022, April). "Hartal (Strike) Happens Here Everyday": Understanding Impact of Disruption on Education in Kashmir. In *Proceedings of the 2022 CHI Conference on Human Factors in Computing Systems* (pp. 1-17).
52. Zargar, W. A., & Ahlawat, J. (2017). Improving E-Learning Support and Infrastructure in Different Districts of Jammu and Kashmir. *Oriental Journal of Computer Science and Technology*, 10(1), 47-59.



**Figure 1: Digital tools used in education sector**

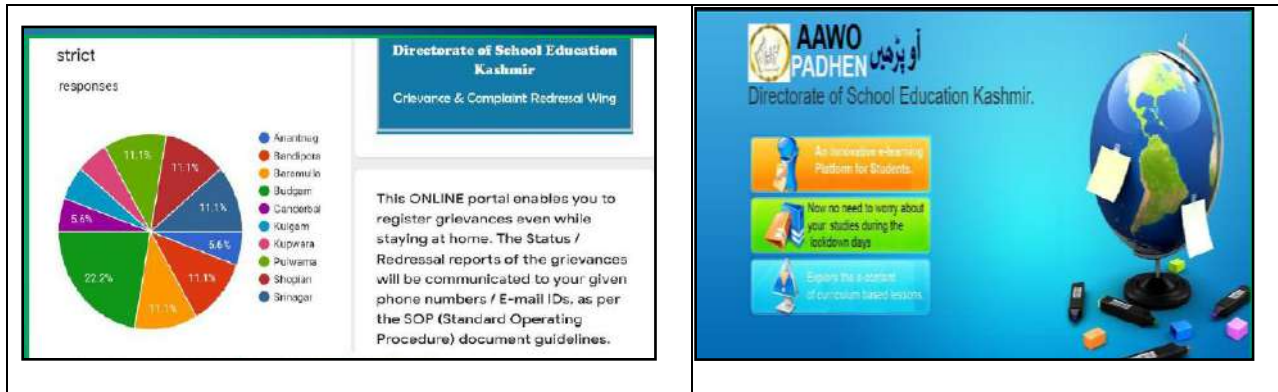


**Figure 2: Learning management system**



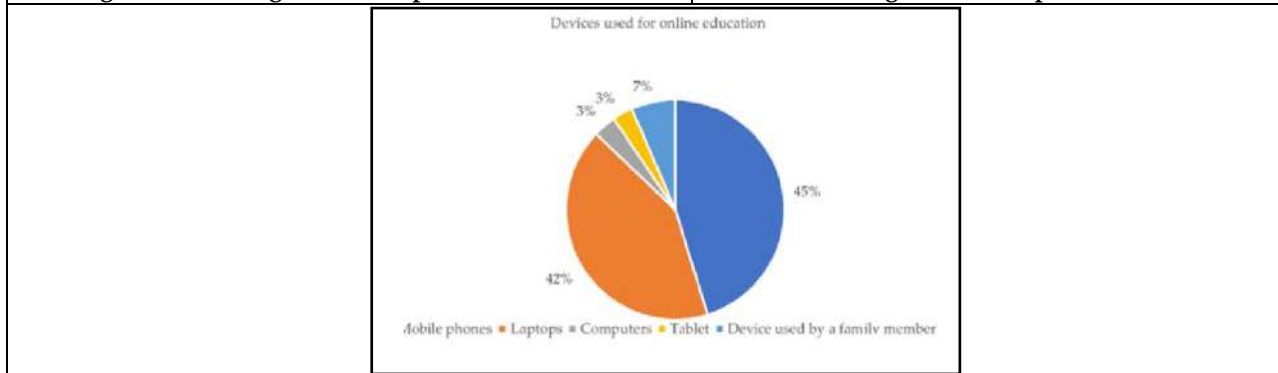


**Aneesa Fayaz and Saravana Kumar**



**Figure 3 : Online grievance responses district wise**

**Figure 4: Aawo padein**



**Figure 5 : Device used for online education**





## A Comprehensive Review on Artificial Intelligence based Depression Detection through Social Media Data Analysis

T.Tamil Elakya<sup>1\*</sup> and K.Manikandan<sup>2</sup>

<sup>1</sup>Research Scholar, Department of Computer Science, PSG College of Arts and Science, Coimbatore - 641014, Tamil Nadu, India.

<sup>2</sup>Associate Professor, Department of Computer Science, PSG College of Arts and Science, Coimbatore - 641014, Tamil Nadu, India.

Received: 22 Jan 2024

Revised: 09 Feb 2024

Accepted: 11 May 2024

### \*Address for Correspondence

**T.Tamil Elakya**

Research Scholar,

Department of Computer Science,

PSG College of Arts and Science,

Coimbatore - 641014, Tamil Nadu, India.

Email: tamilelakya360phd@gmail.com



This is an Open Access Journal / article distributed under the terms of the **Creative Commons Attribution License** (CC BY-NC-ND 3.0) which permits unrestricted use, distribution, and reproduction in any medium, provided the original work is properly cited. All rights reserved.

### ABSTRACT

Depression is a range of psychological conditions that affect attitude, feelings, and overall well-being, and is influenced by various factors. Common symptoms include negative emotions, loss of interest, and persistent sadness. Maintaining a high quality of life is important for managing mental health issues. Social media plays a significant role in allowing individuals to express their emotions and share life events. As mental health challenges continue to increase, there is growing interest in using social network data for early detection of depression. Recent years have seen progress in using Artificial Intelligence (AI) to identify depression on online platforms. This manuscript surveys AI frameworks, such as Machine Learning (ML) and Deep Learning (DL) algorithms, utilized in studies of depression detection from 2020 to 2023. The paper not only presents advancements but also examines the limitations and challenges of these algorithms, such as data heterogeneity, noise, and the subjective nature of mental health expressions online. It aims to identify research gaps and suggest future directions for improving methodologies on online platforms. This exploration contributes to the ongoing discussion about mental health and AI, with implications for researchers, practitioners, and policymakers.

**Keywords:** Depression detection, Social media, AI, Machine learning, Deep learning



**Tamil Elakya and Manikandan****INTRODUCTION**

Depression is a widespread psychological issue affecting over 300 million individuals globally, with increased internet and social media use linked to higher rates of anxiety, depression, and suicide [1]. Women are twice as likely to experience depression as men. During the last centuries, 15.08% of young people aged 12-17 have experienced a minimum of a single catastrophic depression incident, with 10.6% dealing with acute depressive symptoms. Over 60% of young people with acute symptoms do not receive any therapy, and merely 27.2% receive regular therapy. Less than one in three young people with severe depression receive regular care, even when the number of visits is counted [2].

**Types of Depression**

Depression is categorized by symptoms such as unhappiness, lack of motivation, regret, poor dignity, inability to eat or sleep, fatigue, and failure to focus. It can lead to worsening conditions such as joint inflammation, asthma, cardiovascular disease, diabetes, and obesity. Depression may considerably affect an individual's willingness to participate in everyday tasks, and can even lead to thoughts of suicide [3]. It can be divided into two groups based on the intensity of the symptoms: mild and temporary occurrences, and acute and chronic episodes of depression.

**Two primary categories of depression include**

- Major depressive disorder is an acute depression categorized by enduring melancholy, desperation, and unimportance [4]. A minimum of 5 depression signs should occur during a two-week period to be recognized. This condition is classified into unusual, hybrid, melancholy, psychotic, and catatonia by the American Psychiatric Association.
- Persistent Depressive Disorder (PDD): PDD, also called dysthymia, is a less acute yet constant category of depression. To be diagnosed, symptoms must be present for at least two years. It can have a greater impact on a person's life than major depression due to its longer duration [5]. Individuals with PDD often experience sadness, decreased productivity, low self-confidence, and a loss of motivation in daily tasks.

**Social and Cultural Factors Influencing Depressive Disorders in India**

Mental health diseases are widespread in India, affecting a significant portion of the population. The frequency of psychiatric illnesses in India ranges from 9.5 to 370 per 1000 individuals, reflecting the variety of mental health conditions prevalent in the nation [6]. Common mental health illnesses in India include depression, anxiety, bipolar syndrome, schizophrenia, and drug use conditions [7]. Several societal and cultural factors impact depression in India, including stigma surrounding mental illness, gender inequality, poverty, rapid urbanization, family dynamics, and cultural beliefs. These factors contribute to discrimination, isolation, fear, and limited access to quality care, and hinder open discussions about mental health. Addressing these issues is crucial to providing efficient interventions and support networks for the population's mental health needs.

**Social Media Use and Depression**

Social media usage is a highly popular online activity worldwide and it continues to grow. In 2017, over 2.73 billion people used social media, and this number is projected to reach 6 billion by 2027 (see Figure 1). According to Figure 2, Facebook, the leading social networking platform, has over three billion monthly active users and was the first to reach 1 billion registered accounts. It is part of Meta Platforms, which also maintains WhatsApp, Facebook Messenger, and Instagram, with a combined total of over 1 billion monthly users. In the 2<sup>nd</sup> quarter of 2023, Facebook stated over 3.8 billion monthly active users. Social networking sites, existing in various languages, enable users to connect across borders. In 2024, these sites are expected to reach 5.17 billion users, with continued growth expected due to increased mobile device usage and access to underserved markets. Figure 3 shows that 53.8% of internet users globally are men, with 29.8% being aged 20-39, and 31% being aged 20-29, with users over 60 years making up only 9% of web activity in January 2023. According to Figure 4, in January 2023, Facebook's largest user base is aged 25-34,





### Tamil Elakya and Manikandan

with 43% female. Instagram has 30.8% 18-24 users, with 17% male. Twitter has 62.9% male and 37.1% female. YouTube has 54% male users, while TikTok has 54% female users. Figure 5 shows that individuals with higher depression symptoms use social media more frequently [9], with 29% of those using it at least 58 times per week experiencing high depression symptoms, and only 16% experiencing low depression symptoms, compared to 36% of those using it 8 times or fewer. Additionally, it revealed that 32% of social media users follow therapists and mental health professionals, 25% follow individuals with similar mental health conditions, and 20% follow mental health advocates and brands. Frequent social media use is associated with negative moods and may contribute to higher rates of depression, leading to social isolation, reduced enjoyment in activities, and increased anxiety [10]. Multitasking can exacerbate feelings of shame, worthlessness, and jealousy. Comparing oneself online can trigger inadequate emotions, fueling a cycle of jealousy [11]. Studies suggest envy may be a cause of depression, not just a result of social media use. Negative experiences on social media can increase the risk of developing depression [12].

#### Social Networks as a Data Source for Depression Detection

Social networks are useful for detecting depression by analyzing the content and patterns of posts [13]. Key aspects include expressive content, sentiment analysis, behavioral patterns, temporal analysis, social collaboration dynamics, multimodal data analysis, and real-time monitoring. Users often share personal experiences and emotions on social media, allowing for the identification of linguistic cues associated with depression. Natural Language Processing (NLP) techniques can assess sentiment, while changes in online behavior can signal emotional distress. Temporal analysis offers insights into the progression of depressive symptoms, while multimodal data analysis provides a comprehensive understanding of an individual's digital footprint and emotional expressions.

#### Significance of Depression Detection

Detecting depression from social media involves analyzing language, behavior, and social interactions to identify potential signs of depression [14]. This information can be used to provide early intervention and support for those struggling with depression, leading to more effective treatment, reduced stigma, and improved resource allocation. In the workplace, early detection can safeguard employee well-being and improve productivity, ultimately transforming lives and promoting empathy [15].

#### General Methodology for Depression Detection

The detection process involves data pre-processing, feature extraction, feature selection, and classification to detect depression levels [16], as illustrated in Figure 6. This section describes each phase in detail.

- **Pre-processing:** It is a crucial process in analyzing online information, ensuring that the data is clean and suitable for analysis [17]. Key steps include identifying relevant platforms, collecting data using APIs or web scraping tools, cleaning the text by removing irrelevant characters and symbols, breaking down the text into individual words, eliminating common words, reducing words to their base form, handling missing values, removing duplicates, converting emojis and emoticons, normalizing numerical features, converting categorical variables, removing irrelevant data points, handling timestamps and time zones, and addressing class imbalances.
- **Feature extraction:** It involves extracting relevant features that capture linguistic, behavioral, and contextual patterns associated with depressive symptoms [18]. Depression detection on social networking can be achieved using various feature extraction techniques. These include Bag-of-Words (BoW), TF-IDF (Term Frequency-Inverse Document Frequency), word embedding, N-grams, sentiment analysis, user features, content length, hashtag and mention counts, temporal features, user metadata, named entity recognition, network analysis, image and video features, topic modeling, and emotion analysis features. These methods help identify important words, user behavior, content complexity, and temporal patterns in social media behavior. They also consider user metadata, named entity recognition, network analysis, image and video features, topic modeling, and emotion analysis features. These techniques help in identifying important words, identifying latent topics, and analyzing emotional content in social media data.





### Tamil Elakya and Manikandan

- **Feature selection:** It is a technique used to choose the most significant features by removing redundant ones [19]. Common feature selection techniques include SelectKBest, Particle Swarm Optimization (PSO), maximum Relevance Minimum Redundancy (mRMR), Boruta, and ReliefF.
- **Classification:** Social media data is often used to detect depression by using classification algorithms, which include both ML and DL models to differentiate between people with and without depressive symptoms [20]. The most widely used ML-based classification algorithms [21-23] are Naïve Bayes (NB), K-Nearest Neighbor (KNN), Support Vector Machine (SVM), Decision Tree (DT), Random Forest (RF), Gradient Boosting DT (GBDT), Extreme Gradient Boosting (XGBoost), Logistic Regression (LR), and Support Vector Regression (SVR). DL is a category of ML that allows machines to understand the domain through a pyramid of concepts. This allows for complex ideas to be learned by building them from simpler ones. Neural Networks (NNs) such as Artificial NN (ANN), Deep NN (DNN), CNN, and Recurrent NN (RNN) are used as classifiers in detecting depressive disorders [24-26].

This review explores the use of AI in detecting depression through user-generated content on social media. It surveys ML and DL algorithms used for depression detection, highlighting advancements and examining limitations. Additionally, it aims to identify research gaps and suggest future directions to improved depression detection methodologies on online platforms.

#### SURVEY ON DEPRESSION DETECTION FROM SOCIAL MEDIA USING ARTIFICIAL INTELLIGENCE MODELS

Recent studies on detecting depression from online data is primarily split into ML and DL models. This review covers the use of these models in systems developed to identify depression from online information, organized by year of publication.

##### ML-Based Depression Detection

Online platforms are often utilized to identify depression owing to the large quantity of user-created text data and societal behavior. Many studies have used outdated ML algorithms, along with feature engineering techniques to classify and identify depression in online users. This section provides a review of some of these studies. de Jesús Titla-Tlatelpa et al. [27] developed a profile-based sentiment-aware technique using SVM and RF classifiers to detect depression in social media. This technique focuses on classifying user profiles (e.g., males or females) and analyzing the opinions conveyed in their posts using a novel text representation, which learns their polarity (e.g., +ve or -ve). Aguilera et al. [28] used a One-Class Categorizer (OCC) for detecting depression in online networks. They also introduced a new measure for determining the relevance of texts for a given task, using lexicons demarcated by standard knowledge-based techniques. Chiong et al. [29] explored the use of ML classifiers and online data to identify depression in users' posts, even without explicit keywords such as 'depression' or 'diagnosis'. Zhou et al. [30] conducted a study on the detection of community depression dynamics in Australia caused by the COVID-19 epidemic using user-created information on Twitter. First, sentiment, subject, and domain-explicit traits were retrieved. Then, the TF-IDF was developed to accurately identify depression in tweets. Pool-Cen et al. [31] developed a simple classification algorithm to differentiate between tweets associated with depression in English and Spanish. Safa et al. [32] developed an automated method for analyzing tweets and predicting depression signs using N-gram, LIWC lexicons, automated picture labeling, BoW, correlation-based attribute selection, and multiple supervised classifiers. Ghosal & Jain [33] introduced a method for detecting depression on online platforms. The Reddit text data was first pre-processed and normalized. Then, TF-IDF and fast Text embedding were applied to obtain attributes, which were later passed to the XGBoost classifier to identify depressive content. Table 1 evaluates the ML algorithms used in the above-discussed studies for depression detection.

##### DL-Based Depression Detection

Recent studies have shown that DL is more accurate and reliable than traditional ML methods to identify depression in online users. DL's ability to learn complex patterns from large datasets has led to superior performance in depression detection. This section will review recent studies on DL-based approaches for detecting depression from



**Tamil Elakya and Manikandan**

online information. Ding et al. [34] collected Sina Weibo data of college students, utilized DNN for extracting attributes, and adopted a Deep Integrated SVM (DISVM) classifier to detect depression. Wu et al. [35] developed a new method called D3-HDS (DL-based Depression Detection for Heterogeneous Data Sources) using the RNN to calculate the post representations for each individual, which were then integrated into the content-based, social, and living atmosphere attributes to estimate the individual's depression using DNN. Shrestha et al. [36] developed an unsupervised technique using RNN to identify miserable users. They analyzed the users' comments and their networking behavior in the forum. First, user embedding was computed from their post sequence using RNN and then combined with networking behavior. Then, unsupervised anomaly detection was used to classify users as depressed or not. Chiu et al. [37] developed a multimodal depression detection system for Instagram, focusing on the timing of posts. A depression lexicon was generated to gather information on users with miserable tendencies. A 2-phaserecognition strategy was also developed to identify miserable users based on the time interval between their posts. Ren et al. [38] developed a new sentiment-based attention network model for improved depression identification, combining semantic and sentiment understanding networks to extract +ve and -ve emotional data. Lara et al. [39] developed Deep Bag-of-Sub-Emotions (DeepBoSE) to detect depression in online using a differentiable BoW. This model enhances standard BoF that may not be easily combined with the DL structures.

Cha et al. [40] developed the DL prediction system to identify high-risk groups for depression using social media data. They classified depression posts in multiple languages and created a depression vocabulary for all languages. Ansari et al. [41] introduced a hybrid ensemble learning approach for automated depression detection, which involves pre-processing social media posts, extracting sentiment features, using an attention-based LSTM for temporal characteristics, and a linear classifier for final prediction, combining outputs in an ensemble classifier. Amanat et al. [42] developed a text prediction model utilizing One-Hot encoding, Principal Component Analysis (PCA), and LSTM with RNN to detect depression early. Yang et al. [43] developed the KC-Net model utilizing Gated Recurrent Units (GRU) and a knowledge-aware mentalization module to detect depression on online platforms. Nijhawan et al. [44] conducted a study to identify depression in individuals depending on online posts and comments. They utilized large-scale datasets, and Bidirectional Encoder Representations from Transformers (BERT). Additionally, they used Latent Dirichlet Allocation (LDA) to identify word and phrase patterns within documents. Rizwan et al. [45] developed deep-transfer learning language models to classify depression from tweets using a labeled dataset. They assessed the efficiency of different transformer-based models and fine-tuned them for three intensity classes: 'severe', 'moderate', and 'mild'. Zhou et al. [46] created a Time-aware Attention Multimodal Fusion Network (TAMFN) to detect depression in video content using non-verbal cues like acoustics and visuals. The TAMFN model includes a Temporal Convolutional Network (GTCN), Intermodal Feature Extraction (IFE), and a Time-aware Attention Multimodal Fusion (TAMF) module. The GTCN extracts local and global time-based features, IFE captures similarity features, and the TAMF guides feature fusion.

The fused features were then fed to the fully connected layer to detect depression. Zogan et al. [47] developed the Multi-Aspect Depression Detection with Hierarchical Attention Network (MDHAN) to automatically identify miserable users on online platforms. The model uses attention strategies at the tweet and word levels to calculate the importance of all tweets and words, obtaining semantic sequence characteristics for reasonable outcomes. Kour and Gupta [48] developed a hybrid DL framework to detect depression from user tweets utilizing a feature-rich CNN and Bidirectional LSTM (BiLSTM). The model categorizes depressive and non-depressive tweets, analyzing semantic context. Nadeem et al. [49] developed a method using Natural Language Processing (NLP) and DL techniques to detect depression from text data. They manually annotated a tweet dataset, creating binary and ternary labels. This DL-based hybrid SSCL classification framework utilized GloVe for feature extraction, LSTM-CNN for capturing tweet sequence and semantics, GRUs with self-attention for capturing contextual and hidden features, and a fully connected layer for identifying depression. Li et al. [50] developed a Multimodal Hierarchical Attention (MHA) framework to detect depression on online platforms, processing multiple data types simultaneously and using an attention mechanism to identify depression-related information. A distribution normalization method improved performance by aligning data distribution. Table 2 evaluates the DL algorithms used in the above-discussed studies to identify depression on social networks. The reviewed studies show different methods for using ML and DL





### Tamil Elakya and Manikandan

algorithms to detect depression in social media users. Each algorithm has strengths and weaknesses, highlighting the complexity of detecting depression. Evaluation metrics like Acc, P, R, and F1 offer awareness of algorithm effectiveness. Figure 7-10 illustrates the importance of selecting the most suitable algorithm based on specific context and data characteristics. It can be inferred that [49] achieves the highest Acc and F1, [48] has the maximum P, and [38] has the highest R compared to other DL algorithms. However, a robust ensemble DL algorithm that incorporates multi-source data is necessary to improve depression detection accuracy as the field evolves.

## CONCLUSION

This article discusses recent studies on using AI to identify depression from online text. Additionally, it highlights the importance of advanced AI techniques in depression detection. The study found that DL with attention strategies is more effective than traditional ML for detecting depression. Future advancements could include multimodal analysis, temporal analysis, and privacy-preserving methods. These techniques could enable real-time monitoring and proactive interventions, while also addressing privacy concerns and promoting user acceptance.

## REFERENCES

1. J.M. Twenge, "Increases in Depression, Self-Harm, and Suicide among US Adolescents after 2012 and Links to Technology Use: Possible Mechanisms," *Psychiatric Research and Clinical Practice*, vol. 2, no. 1, pp. 19-25, Sep. 2020.
2. *The State of Mental Health in America*. (n.d.). Mental Health America. <https://www.mhanational.org/issues/state-mental-health-america>
3. M.D. Manzar, A. Albougami, N. Usman, and M.A. Mamun, "Suicide among Adolescents and Youths during the COVID-19 Pandemic Lockdowns: A Press Media Reports-Based Exploratory Study," *Journal of Child and Adolescent Psychiatric Nursing*, vol. 34, no. 2, pp. 139-146, May 2021.
4. L. Gutiérrez-Rojas, A. Porras-Segovia, H. Dunne, N. Andrade-González, and J.A. Cervilla, "Prevalence and Correlates of Major Depressive Disorder: A Systematic Review," *Brazilian Journal of Psychiatry*, vol. 42, pp. 657-672, Aug. 2020.
5. E. Schramm, D.N. Klein, M. Elsaesser, T.A. Furukawa, and K. Domschke, "Review of Dysthymia and Persistent Depressive Disorder: History, Correlates, and Clinical Implications," *The Lancet Psychiatry*, vol. 7, no. 9, pp. 801-812, Sep. 2020.
6. R. Sagar, R. Dandona, G. Gururaj, R.S. Dhaliwal, A. Singh, A. Ferrari, ... and L. Dandona, "The Burden of Mental Disorders across the States of India: The Global Burden of Disease Study 1990–2017," *The Lancet Psychiatry*, vol. 7, no. 2, pp. 148-161, Feb. 2020.
7. V.R. Meghrajani, M. Marathe, R. Sharma, A. Potdukhe, M.B. Wanjari, A.B. Taksande, ... and M. Wanjari, "A Comprehensive Analysis of Mental Health Problems in India and The Role of Mental Asylums," *Cureus*, vol. 15, no. 7, pp. 1-11, Jul. 2023.
8. M.G. Hunt, R. Marx, C. Lipson, and J. Young, "No More FOMO: Limiting Social Media Decreases Loneliness and Depression," *Journal of Social and Clinical Psychology*, vol. 37, no. 10, pp. 751-768, Dec. 2018.
9. L.Y. Lin, J.E. Sidani, A. Shensa, A. Radovic, E. Miller, J.B. Colditz, ... and B.A. Primack, "Association between Social Media Use and Depression among US Young Adults," *Depression and Anxiety*, vol. 33, no. 4, pp. 323-331, Apr. 2016.
10. Z.E. Seidler, M.J. Wilson, S.M. Rice, D. Kealy, J.L. Oliffe, and J.S. Ogradniczuk, "Virtual Connection, Real Support? A Study of Loneliness, Time on Social Media and Psychological Distress among Men," *International Journal of Social Psychiatry*, vol. 68, no. 2, pp. 288-293, Mar. 2022.
11. J. Goodwin, L. Behan, and N. O'Brien, "Teachers' Views and Experiences of Student Mental Health and Well-Being Programmes: A Systematic Review," *Journal of Child & Adolescent Mental Health*, vol. 33, no. 1-3, pp. 55-74, Sep. 2021.







### Tamil Elakya and Manikandan

12. A.Hartanto, F.Y. Quek, G.Y. Tng, and J.C. Yong, "Does Social Media Use Increase Depressive Symptoms? A Reverse Causation Perspective," *Frontiers in Psychiatry*, vol. 12, p. 641934, Mar. 2021.
13. F.T. Giuntini, M.T. Cazzolato, M.D.J.D. dos Reis, A.T. Campbell, A.J. Traina, and J. Ueyama, "A Review on Recognizing Depression in Social Networks: Challenges and Opportunities," *Journal of Ambient Intelligence and Humanized Computing*, vol. 11, pp. 4713-4729, Nov. 2020.
14. K.C. Bathina, M. Ten Thij, L. Lorenzo-Luaces, L.A. Rutter, and J. Bollen, "Individuals with Depression Express more Distorted Thinking on Social Media," *Nature Human Behaviour*, vol. 5, no. 4, pp. 458-466, Apr. 2021.
15. L.E. Søvdold, J.A. Naslund, A.A. Kousoulis, S. Saxena, M.W. Qoronfleh, C. Grobler, and L. Münter, "Prioritizing the Mental Health and Well-Being of Healthcare Workers: An Urgent Global Public Health Priority," *Frontiers in Public Health*, vol. 9, p. 679397, May 2021.
16. S. Aleem, N.U. Huda, R. Amin, S. Khalid, S.S. Alshamrani, and A. Alshehri, "Machine Learning Algorithms for Depression: Diagnosis, Insights, and Research Directions," *Electronics*, vol. 11, no. 7, p. 1111, Mar. 2022.
17. M.O. Hegazi, Y. Al-Dossari, A. Al-Yahy, A. Al-Sumari, and A. Hilal, "Preprocessing Arabic Text on Social Media," *Heliyon*, vol. 7, no. 2, pp. 1-15, Feb. 2021.
18. S. Guohou, Z. Lina, and Z. Dongsong, "What Reveals about Depression Level? The Role of Multimodal Features at the Level of Interview Questions," *Information & Management*, vol. 57, no. 7, p. 103349, Nov. 2020.
19. Z. Dai, H. Zhou, Q. Ba, Y. Zhou, L. Wang, and G. Li, "Improving Depression Prediction Using a Novel Feature Selection Algorithm Coupled with Context-Aware Analysis," *Journal of Affective Disorders*, vol. 295, pp. 1040-1048, Dec. 2021.
20. N.V. Babu and E.G.M. Kanaga, "Sentiment Analysis in Social Media Data for Depression Detection Using Artificial Intelligence: A Review," *SN Computer Science*, vol. 3, pp. 1-20, Jan. 2022.
21. D. Liu, X.L. Feng, F. Ahmed, M. Shahid, and J. Guo, "Detecting and Measuring Depression on Social Media Using a Machine Learning Approach: Systematic Review," *JMIR Mental Health*, vol. 9, no. 3, p. e27244, Mar. 2022.
22. A. Ahmed, S. Aziz, C.T. Toro, M. Alzubaidi, S. Irshaidat, H.A. Serhan, ... and M. Househ, "Machine Learning Models to Detect Anxiety and Depression through Social Media: A Scoping Review," *Computer Methods and Programs in Biomedicine Update*, vol. 2, p. 100066, Sep. 2022.
23. J. Mothe, F. Ramiandrisoa, and M.Z. Ullah, "Comparison of Machine Learning Models for Early Depression Detection from Users' Posts," In: *Early Detection of Mental Health Disorders by Social Media Monitoring: The First Five Years of the eRisk Project*, Cham: Springer International Publishing, pp. 111-139, Sep. 2022.
24. M.Z. Uddin, K.K. Dysthe, A. Følstad, and P.B. Brandtzaeg, "Deep Learning for Prediction of Depressive Symptoms in a Large Textual Dataset," *Neural Computing and Applications*, vol. 34, no. 1, pp. 721-744, Jan. 2022.
25. S. Ghosh and T. Anwar, "Depression Intensity Estimation via Social Media: A Deep Learning Approach," *IEEE Transactions on Computational Social Systems*, vol. 8, no. 6, pp. 1465-1474, Jun. 2021.
26. J. Kim, J. Lee, E. Park, and J. Han, "A Deep Learning Model for Detecting Mental Illness from User Content on Social Media," *Scientific Reports*, vol. 10, no. 1, p. 11846, Jul. 2020.
27. J. de Jesús Titla-Tlatelpa, R.M. Ortega-Mendoza, M. Montes-y-Gómez, and L. Villaseñor-Pineda, "A Profile-Based Sentiment-Aware Approach for Depression Detection in Social Media," *EPJ Data Science*, vol. 10, no. 1, p. 54, Dec. 2021.
28. J. Aguilera, D.I.H. Farías, R.M. Ortega-Mendoza, and M. Montes-y-Gómez, "Depression and Anorexia Detection in Social Media as a One-Class Classification Problem," *Applied Intelligence*, vol. 51, pp. 6088-6103, Aug. 2021.
29. R. Chiong, G.S. Budhi, S. Dhakal, and F. Chiong, "A Textual-Based Featuring Approach for Depression Detection Using Machine Learning Classifiers and Social Media Texts," *Computers in Biology and Medicine*, vol. 135, p. 104499, Aug. 2021.
30. J. Zhou, H. Zogan, S. Yang, S. Jameel, G. Xu, and F. Chen, "Detecting Community Depression Dynamics due to Covid-19 Pandemic in Australia," *IEEE Transactions on Computational Social Systems*, vol. 8, no. 4, pp. 982-991, Jan. 2021.



**Tamil Elakya and Manikandan**

31. J. Pool-Cen, H. Carlos-Martínez, G. Hernández-Chan, and O. Sánchez-Siordia, "Detection of Depression-Related Tweets in Mexico Using Crosslingual Schemes and Knowledge Distillation," *Healthcare*, vol. 11, no. 7, p. 1057, Apr. 2023.
32. R. Safa, P. Bayat, and L. Moghtader, "Automatic Detection of Depression Symptoms in Twitter Using Multimodal Analysis," *The Journal of Supercomputing*, vol. 78, no. 4, pp. 4709-4744, Mar. 2022.
33. S. Ghosal and A. Jain, "Depression and Suicide Risk Detection on Social Media Using fastText Embedding and XGBoost Classifier," *Procedia Computer Science*, vol. 218, pp. 1631-1639, Jan. 2023.
34. Y. Ding, X. Chen, Q. Fu, and S. Zhong, "A Depression Recognition Method for College Students Using Deep Integrated Support Vector Algorithm," *IEEE Access*, vol. 8, pp. 75616-75629, Apr. 2020.
35. M.Y. Wu, C.Y. Shen, E.T. Wang, and A.L. Chen, "A Deep Architecture for Depression Detection Using Posting, Behavior, and Living Environment Data," *Journal of Intelligent Information Systems*, vol. 54, pp. 225-244, Apr. 2020.
36. A.Shrestha, E. Serra, and F. Spezzano, "Multi-Modal Social and Psycho-Linguistic Embedding via Recurrent Neural Networks to Identify Depressed Users in Online Forums," *Network Modeling Analysis in Health Informatics and Bioinformatics*, vol. 9, pp. 1-11, Dec. 2020.
37. C.Y. Chiu, H.Y. Lane, J.L. Koh, and A.L. Chen, "Multimodal Depression Detection on Instagram Considering Time Interval of Posts," *Journal of Intelligent Information Systems*, vol. 56, 25-47, Feb. 2021.
38. L. Ren, H. Lin, B. Xu, S. Zhang, L. Yang, and S. Sun, "Depression Detection on Reddit with an Emotion-Based Attention Network: Algorithm Development and Validation," *JMIR Medical Informatics*, vol. 9, no. 7, p. e28754, Jul. 2021.
39. J.S. Lara, M.E. Aragón, F.A. González, and M. Montes-y-Gómez, "Deep Bag-of-Sub-Emotions for Depression Detection in Social Media," In" *Proceedings of 24<sup>th</sup> International Conference on Text, Speech, and Dialogue*, Springer International Publishing, pp. 60-72, Sep. 2021.
40. J. Cha, S. Kim, and E. Park, "A Lexicon-Based Approach to Examine Depression Detection in Social Media: The Case of Twitter and University Community," *Humanities and Social Sciences Communications*, vol. 9, no. 1, pp. 1-10, Sep. 2022.
41. L. Ansari, S. Ji, Q. Chen, and E. Cambria, "Ensemble Hybrid Learning Methods for Automated Depression Detection," *IEEE Transactions on Computational Social Systems*, vol. 10, no. 1, pp. 211-219, Mar. 2022.
42. A. Amanat, M. Rizwan, A.R. Javed, M. Abdelhaq, R. Alsaqour, S. Pandya, and M. Uddin, "Deep Learning for Depression Detection from Textual Data," *Electronics*, vol. 11, no. 5, p. 676, Feb. 2022.
43. K. Yang, T. Zhang, and S. Ananiadou, "A Mental State Knowledge-Aware and Contrastive Network for Early Stress and Depression Detection on Social Media," *Information Processing & Management*, vol. 59, no. 4, p. 102961, Jul. 2022.
44. T. Nijhawan, G. Attigeri, and T. Ananthkrishna, "Stress Detection Using Natural Language Processing and Machine Learning over Social Interactions," *Journal of Big Data*, vol. 9, no. 1, pp. 1-24, Dec. 2022.
45. M. Rizwan, M.F. Mushtaq, U. Akram, A. Mehmood, I. Ashraf, and B. Sahelices, "Depression Classification from Tweets Using Small Deep Transfer Learning Language Models," *IEEE Access*, vol. 10, pp. 129176-129189, Nov. 2022.
46. L. Zhou, Z. Liu, Z. Shangguan, X. Yuan, Y. Li, and B. Hu, "TAMFN: Time-Aware Attention Multimodal Fusion Network for Depression Detection," *IEEE Transactions on Neural Systems and Rehabilitation Engineering*, vol. 31, pp. 669-679, Nov. 2022.
47. H. Zogan, I. Razzak, X. Wang, S. Jameel, and G. Xu, "Explainable Depression Detection with Multi-Aspect Features Using a Hybrid Deep Learning Model on Social Media," *World Wide Web*, vol. 25, no. 1, pp. 281-304, Jan. 2022.
48. H. Kour and M.K. Gupta, "An Hybrid Deep Learning Approach for Depression Prediction from User Tweets Using Feature-Rich CNN and Bi-Directional LSTM," *Multimedia Tools and Applications*, vol. 81, no. 17, pp. 23649-23685, Jul. 2022.
49. A. Nadeem, M. Naveed, M. Islam Satti, H. Afzal, T. Ahmad, and K.I. Kim, "Depression Detection Based on Hybrid Deep Learning SSCL Framework Using Self-Attention Mechanism: An Application to Social Networking Data," *Sensors*, vol. 22, no. 24, p. 9775, Dec. 2022.





**Tamil Elakya and Manikandan**

50. Z. Li, Z. An, W. Cheng, J. Zhou, F. Zheng, and B. Hu, "MHA: A Multimodal Hierarchical Attention Model for Depression Detection in Social Media," *Health Information Science and Systems*, vol. 11, no. 1, p. 6, Jan. 2023.

**Table 1. Comparison of ML-Based Depression Detection Models**

Ref. No.	Algorithms	Benefits	Limitations	Data Source	Evaluation Metrics
[27]	SVM and RF	Gender-based classification was highly effective than age-based ones.	The results were impacted by the size and time variation in users' message records.	Reddit and Twitter	<b>F1:</b> <i>Gender-based classifier:</i> Reddit = 0.71; Twitter = 0.89 <i>Age-based classifier:</i> Reddit = 0.68; Twitter = 0.88
[28]	OCC with k-strongest strengths scheme	A competitive method for detecting psychological illnesses from online data.	There are often few positive examples (depressed individuals), which creates an imbalanced dataset and makes it difficult for the model to accurately identify positive cases.	Depression and Anorexia collections from eRisk forum	Average F1 = 0.557
[29]	LR, linear kernel SVM, Multi-Layer Perceptron (MLP), DT, RF, adaptive boosting, bagging predictors, and GB	The efficiency was enhanced when utilizing less rigidly structured corpora, particularly while detecting depression in data from various sources.	The training of the classifiers was restricted to using labeled datasets, and the accuracy was decreased in a dataset with a significant imbalance.	Twitter, Victoria's diary, Reddit, and Facebook	<b>Twitter:</b> Acc = 99.8%; <b>Victoria's diary:</b> Acc = 1.61%; <b>Reddit:</b> Acc = 40.54%; <b>Facebook:</b> Acc = 16.3%
[30]	TF-IDF features, LR, linear discriminant analysis, and Gaussian NB (GNB)	It can efficiently identify community depression dynamics at the nation level.	There was no analysis done on how depression changed over period and in different locations.	Twitter	<b>LR:</b> Acc = 0.903; P = 0.908; R = 0.899; F1 = 0.902 <b>Linear discriminant analysis:</b> Acc = 0.904; P = 0.912; R = 0.899; F1 = 0.903 <b>GNB:</b> Acc = 0.879; P = 0.891; R = 0.874;





**Tamil Elakya and Manikandan**

					F1 = 0.878
[31]	Knowledge distillation, IVIS-based dimensionality reduction, LR, SVM, and Quadratic Discriminant Analysis (QDA)	Improved performance even without labeled data.	High computational cost due to two stages: building embedded space for sentences in different languages and using dimensionality reduction algorithms.	Twitter data in English and Spanish languages	<p><b>LR:</b> Acc = 0.95; P = 0.96; R = 0.94; F1 = 0.95</p> <p><b>SVM:</b> Acc = 0.95; P = 0.96; R = 0.93; F1 = 0.95</p> <p><b>QDA:</b> Acc = 0.95; P = 0.96; R = 0.93; F1 = 0.94</p>
[32]	SVM, LR, DT, GB, RF, Ridge categorizer, AdaBoost, CatBoost, and MLP	The performance was acceptable.	It did not take into account every significant attribute in the user profile.	Twitter	<p><b>LR:</b> Acc = 0.75; P = 0.74; R = 0.75; F1 = 0.75</p> <p><b>GB:</b> Acc = 0.91; P = 0.97; R = 0.84; F1 = 0.89</p> <p><b>Ridge categorizer:</b> Acc = 0.77; P = 0.77; R = 0.75; F1 = 0.76</p> <p><b>CatBoost:</b> Acc = 0.91; P = 0.99; R = 0.82; F1 = 0.89</p> <p><b>MLP:</b> Acc = 0.70; P = 0.69; R = 0.72; F1 = 0.7</p>
[33]	fastText embedding and XGBoost	High accuracy of classifying lengthy Reddit posts.	It needs various negative emotions and anxiety-based features.	Reddit	<p>P = 0.71; R = 0.71; F1 = 0.71; Acc = 71.05%</p>

\*Note: P=Precision; R=Recall; F1=F1 score; Acc=Accuracy





**Tamil Elakya and Manikandan**

**Table 2. Comparative Analysis of DL-Based Depression Detection Systems**

Ref. No.	Algorithms	Benefits	Limitations	Data Source	Evaluation Metrics
[34]	DISVM	It decreased the execution period and increased detection efficacy.	The accuracy relies on the selection of features, which was subjective in this case.	Sina Weibo	<b>Precision:</b> Training = 0.881; Testing = 0.8615
[35]	D3-HDS using RNN and DNN	By concurrently considering all content-based, behavioral, and demographic features, it can achieve better performance.	Additional features such as demographic and psychological characteristics are needed to enhance the efficiency of detection.	Real dataset include Facebook records and the CES-D screening test results	P = 83.3%; R = 71.4%; F1 = 76.9%
[36]	RNN	Improved detection by fusing network and psycholinguistic features.	The performance depends on the choice of model parameters.	ReachOut.com platform	F1 = 0.64; P = 0.64 R = 0.64
[37]	AlexNet, BiLSTM, RF and AdaBoost	It improved detection performance.	Collecting more data features took a long time.	Instagram	P = 0.895; R = 0.782; F1 = 0.835
[38]	BiLSTM & dynamic fusion mechanism	Improved detection by incorporating emotional semantic information.	Multitask learning was essential for detecting depression based on symptom levels.	Reddit	Acc = 91.3%; P = 91.91%; R = 96.15%; F1 = 93.98%
[39]	DeepBoSE	The performance was satisfactory.	The deep representation learning capability was ineffective.	eRisk17 and eRisk18	<b>eRisk2017:</b> F1 = 0.6415; Acc = 0.91; P = 0.6296; R = 0.6538 <b>eRisk2018:</b> F1 = 0.6545; Acc = 0.93; P = 0.6279; R = 0.6835
[40]	1D-CNN, BiLSTM, and BERT	It achieved a satisfactory F1 score.	The accuracy between different domain communities was low due to the absence of demographic data.	Twitter data in Koeran, English, and Japanese languages	<b>Acc:</b> 1D-CNN = 0.5831; BiLSTM = 0.5638; BERT = 0.7252
[41]	LR and attention-based LSTM with linear classifier	Using sentiment lexicon features results in enhanced performance.	It should be included additional features like POS tags to	CLPsych, Reddit, and eRisk	<b>CLPsych:</b> P = 0.655; R = 0.65; F1 = 0.6509;





**Tamil Elakya and Manikandan**

			handle imbalanced datasets.		<p>Acc = 0.65</p> <p><b>Reddit:</b> P = 0.8115; R = 0.7512; F1 = 0.7701; Acc = 0.751</p> <p><b>eRisk:</b> P = 0.8005 R = 0.7455; F1 = 0.7655; Acc = 0.755</p>
[42]	One-hot encoding, PCA, LSTM and RNN	It achieved maximum accuracy.	It didn't consider user's behavior and psycho-linguistic features.	Tweets-Scraped dataset from Kaggle	<p>P = 0.98; R = 0.99; F1 = 0.98; Acc = 99%</p>
[43]	KC-Net using GRU	It can maximize performance by fully utilizing label information to capture class-specific features.	It did not taken into account other information like demographic and behavior features of users.	Depression_Mixed, Dreddit, and SAD	<p><b>Depression_Mixed:</b> P = 95.5%; R = 95.3%; F1 = 95.4%</p> <p><b>Dreddit:</b> P = 84.1%; R = 83.3%; F1 = 83.5%</p> <p><b>SAD:</b> P = 75.6%; R = 77.6%; F1 = 77%</p>
[44]	LDA and BERT	It achieved the highest accuracy.	It did not take into account the mental health factors, making it difficult to handle bipolar emotions.	Twitter	Acc = 94%
[45]	Electra small generator, Electra small discriminator, XtremeDistil-L6, and Albert base V2	It achieved a high F1 score in a relatively short training time per epoch.	The model was trained using short tweets, so it may not be effective at predicting the intensity of depression in longer pieces of text.	Twitter	<p><b>Acc:</b> Electra smallgenerator = 92%; Electra small discriminator = 92%; XtremeDistil-L6 = 92%; Albert base V2 = 92%</p>
[46]	TAMFN	By combining multiple features, it was able to achieve a high recall rate.	Accurate detection was difficult to get because of the varying distribution of test and training data	D-Vlog dataset from YouTube	<p>P = 66.02%;R = 66.5%; F1 = 65.82%</p>





**Tamil Elakya and Manikandan**

			caused by the complexity and noise of non-verbal variables.		
[47]	MDHAN	Computationally effective for identifying depressed users.	It didn't consider a mix of short and long user-generated content.	Twitter	Acc = 0.89; P = 0.902; R = 0.892; F1 = 0.893
[48]	Feature-rich CNN and BiLSTM	The best detection performance was achieved.	Various mixtures of NN layers and activations should be explored to increase the model's accuracy.	Twitter	Acc = 94.28%; P = 96.99%; R = 92.66%; F1 = 94.8%
[49]	Hybrid SSCL	Detection performance was improved.	The tweet did not accurately convey the context and subject, making it difficult for classification of multiple classes.	Twitter dataset from Kaggle	<b>Binary data:</b> Acc = 97%; F1 = 97.4% <b>Ternary data:</b> Acc = 82.9%; F1 = 82.9%
[50]	MHA	This improves data distribution and detection efficiency.	The user's data does not show signs of depression, making it challenging for the model to make accurate predictions.	Sina Weibo	Acc = 92.84%; F1 = 92.78%

\*Note: P=Precision; R=Recall; F1=F1 score; Acc=Accuracy

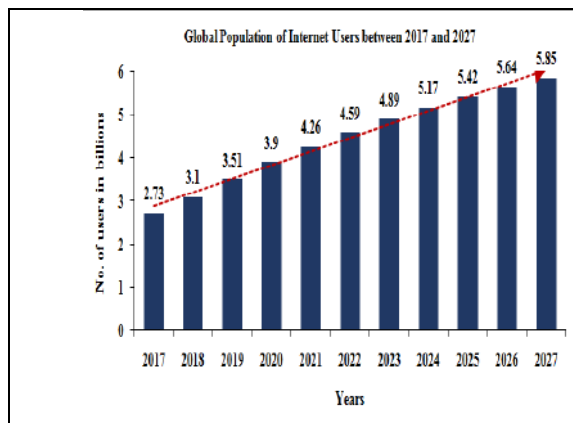


Figure 1. No. of Internet Users Worldwide between 2017 and 2027(Source: Statista 2024)

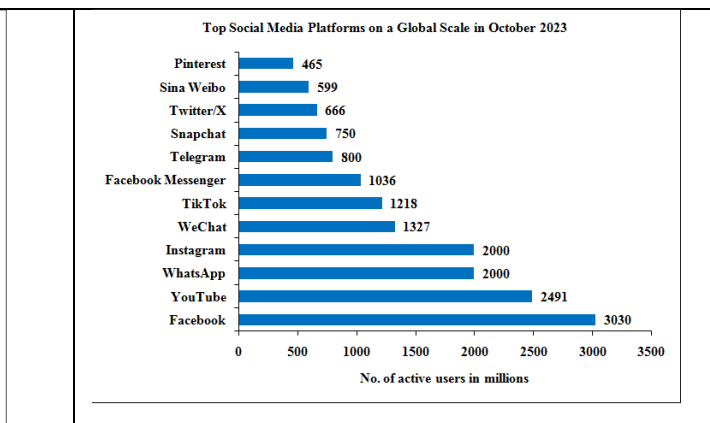


Figure 2. Social Media Platforms Sorted by No. of Users Worldwide in 2023 (Source: Statista 2024)





**Tamil Elakya and Manikandan**

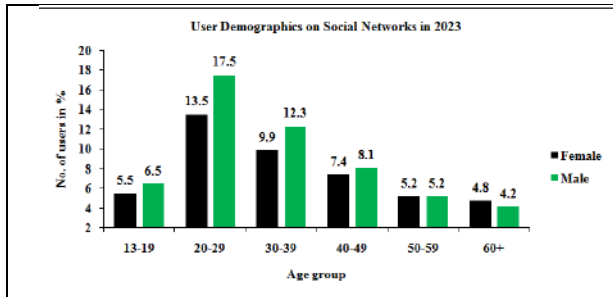


Figure 3. User Demographicson Social Networks in 2023 (Source: datareportal.com June 2023)

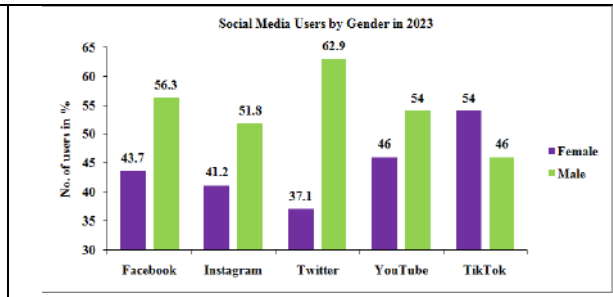


Figure 4. Social Media Users by Gender in 2023 (Source: Social media statistics and trends in 2024 by Antara Agarwal)

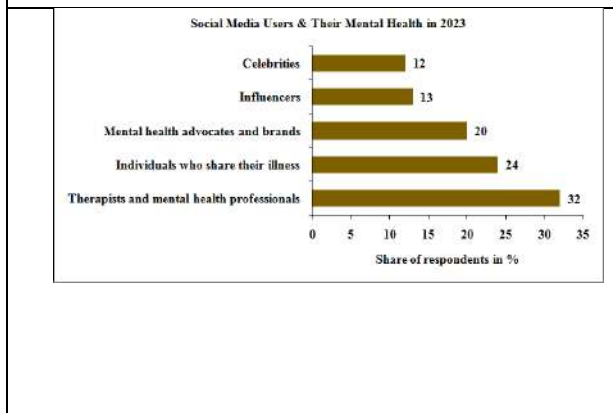


Figure 5. Social Media Users & Mental Health in 2023 (Source: StyleCaster; Mental.; The Mental Health Coalition; 2023; 2255 respondents; 25-44 years; active social media users)

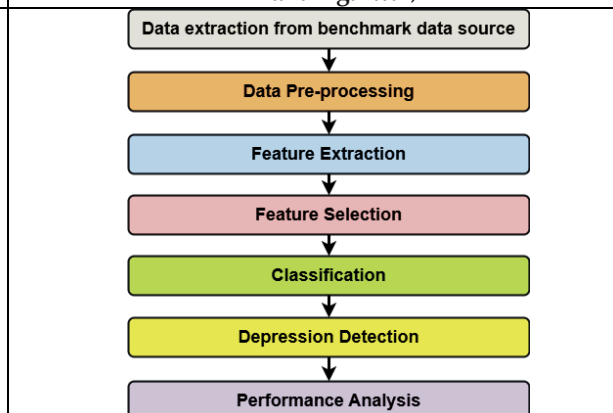


Figure 6. General Methodology in Depression Detection

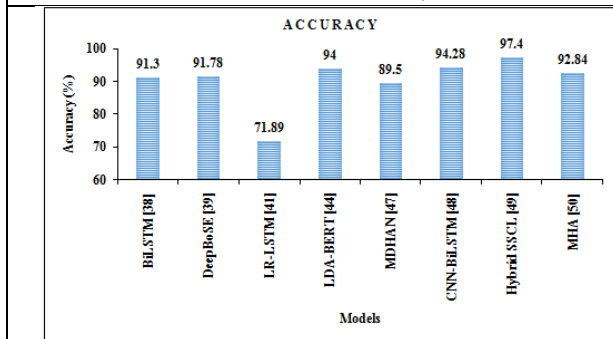


Figure 7. Comparison of Accuracy for Different Depression Detection Models

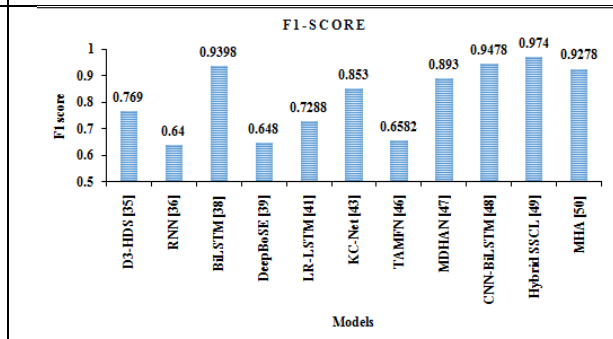


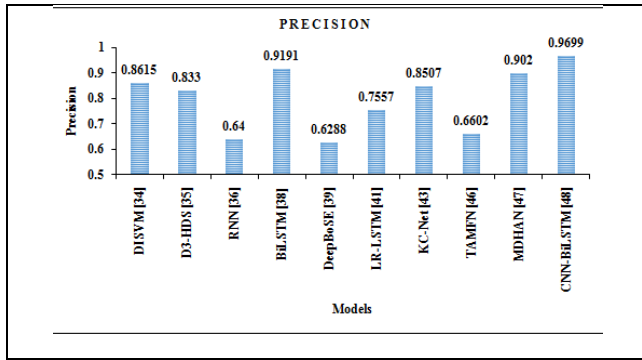
Figure 8. Comparison of F1 Score for Different Depression Detection Models



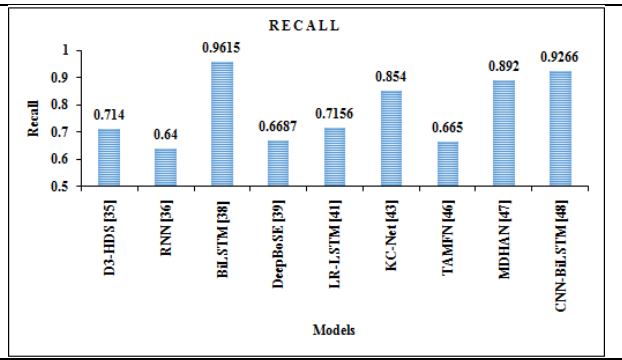




**Tamil Elakya and Manikandan**



**Figure 9. Comparison of Precision for Different Depression Detection Models**



**Figure 10. Comparison of Recall for Different Depression Detection Models**





## A Theory of Constraints Approach using Simulation in Single Sampling Inspection Plans for A-Type Production Plants

S. Ravi Sankar<sup>1\*</sup> and D. Maheswari<sup>2</sup>

<sup>1</sup>Associate Professor, Department of Statistics, Government Arts College, (Affiliated to Bharathiar University) Coimbatore, Tamil Nadu, India.

<sup>2</sup>Research Scholar, Department of Statistics, Government Arts College, (Affiliated to Bharathiar University) Coimbatore, Tamil Nadu, India.

Received: 22 Jan 2024

Revised: 09 Feb 2024

Accepted: 06 May 2024

### \*Address for Correspondence

**S. Ravi Sankar**

Associate Professor,  
Department of Statistics,  
Government Arts College,  
(Affiliated to Bharathiar University)  
Coimbatore, Tamil Nadu, India.



This is an Open Access Journal / article distributed under the terms of the **Creative Commons Attribution License** (CC BY-NC-ND 3.0) which permits unrestricted use, distribution, and reproduction in any medium, provided the original work is properly cited. All rights reserved.

### ABSTRACT

In this paper, an attempt is made to construct the single sampling inspection plans for A-type production plants through the Theory of Constraints (TOC) approach using simulation software. The Theory of Constraints concept is applied using simulation model developed with the help of a simulation software, called Goldsim (14.0), by fixing the lot size, to construct the single sampling inspection plans for A-type production plants. These single sampling plans are presented as tables along with Return on Investment (ROI) for various values of the proportion defectives.

**Keywords:** Theory of Constraints, Simulation Modelling, A-type production plants, Single sampling plans.

### INTRODUCTION

Acceptance sampling begins with determining the lot size for the lot to be checked followed by the number of items to be sampled, and finally the acceptance number for the defectives in the sample. The process is usually followed by an inspection procedure before the items are to be shipped to the throughput. The aim is to identify the quality of the items with a specific level of statistical certainty without testing each and every unit of the lot. The organization decides whether to accept or reject the lot, based on the results of the sampling inspection. The main goal of the Theory of Constraints (TOC) system is to produce the products so as to increase the throughput values. TOC mainly focuses on constraints which prevent the target to be achieved. In this study, a working station is assumed as the





### Ravi Sankar and Maheswari

main constraint (WC3) for this system due to slow process. This constraint has to be removed to improve the quality of the final products. In Acceptance Sampling theory, Soundarajan [13] developed the concept of Maximum Allowable Proportion Defective (MAPD) and suggested a selection procedure for Single Sampling Plan (SSP) indexed through MAPD. Grubbs [7] has given a method for the selection of SSP, for the given Average Quality Level and Limiting Quality Level based on the Poisson approximation to the binomial model. Schilling and Johnson [14] have developed tables for the construction and evaluation of Single Sampling Plan, Double Sampling Plan and Multiple Sampling Plan. Cox Schleier [3] discussed the bottle necks of a process of ongoing improvement applied in the five focusing steps: identify the constraint, decide how to exploit the identified constraint, subordinate constraint, elevate the system constraint and if constraint has been broken and return to the beginning of the first step. Gupta and Boyd [8] have discussed the concept of TOC for operations management. Goldratt and Cox [5] explained the applications of TOC concept in various areas such as thinking process, marketing, production distribution, sales, finance, management, production plants and drum buffer ropes. TOC is to find a constraint of the systems, for improving the throughput values and the productivity of the entire system. Dettmer [4] described how to identify and to optimize the system constraints in the performance of an organization. Oglethorpe and Heron [10] proposed the application of TOC for supply chain management in food industries. Blackstone [1] applied TOC in various areas of marketing, supply chains and sales. Goldratt Schragenheim and Ptak [6], Chowdhars [2], Cox Schleier [3] Roser, Lorentzen and Deuse [11], Scheinkopf [15] Mabin and Baldstone [9] have applied the TOC in their production planning process and suggested strategies to improve the performance and application of management concepts. Ravi Sankar and Maheshwari [12] have applied the Theory of Constraints Approach using Simulation in Sampling inspection for V-type Production Plants.

#### The notations and abbreviations used in this study are

N: lot size

p: proportion defective

$n_p$ : sample size for the inspection used before capacity constraint resource batch

$c_p$ : acceptance number for the inspection used before capacity constraint resource batch

$n_q$ : sample size for the inspection used prior to the shipment

$c_q$ : acceptance number for the inspection used prior to the shipment

TOC: Theory of Constraints

SSP: Single Sampling Plan

SSP ( $n_p, c_p$ ) ( $n_q, c_q$ ): SSP with ( $n_p, c_p$ ) for inspection before WC3 and SSP ( $n_q, c_q$ ) for inspection prior to shipment of finished product.

ROI: Return on Investment

CCR: Capacity Constraint Resource

#### A-type Production Plant

A-type production plant is a special type of production plant in which the arrangement of different work stations in the form of alphabet 'A'. The parts to be assembled passes from one operation to another during the production process. It is used for machine, equipment, workers, and the products to assemble in a sequential order. In a production plant, there are many sub-assemble parts converging to a final assembly. The general flow of material is many-to-one. The major point in A-plants is the converging lines so that each one delivers the final assembly point at the perfect time.

## RESEARCH METHODOLOGY

In this study, an A-type production process which needs three types of Raw material, Raw material-1, Raw-material-2, Raw-material-3 to produce three different parts part-A, part-B and part-C which are assembled for giving the final product is considered. A CCR is the most influencing factor affecting the quality of the final product, which is to be controlled by using the Single Sampling Plan constructed by considering the nature of the A-type production process





### Ravi Sankar and Maheswari

so as to increase the throughput values. A simulation model is developed using Goldsim software, for the A-type production process to construct Single Sampling Plans to apply at two different stages one just before CCR and the other prior to the shipment for improving the quality of the assembled products. Using the simulation model developed, by fixing the lot size  $N$  and by giving the various proportion defective ( $p$ ) values, the Single Sampling Plans ( $n_p, c_p$ ) ( $n_q, c_q$ ) to use SSP ( $n_p, c_p$ ) just before CCR and to use SSP ( $n_q, c_q$ ) prior to shipment of the final products, are obtained along with ROI%. The proportion defective values for the required ROI of the product, are found out using the Goldsim software by designing a simulation model for A-type production plants. This implementation is effective in the production process, in which three parts are produced and assembled as finished product, having a CCR (WC3), drum buffers, drum beats and drum ropes.

#### Development of Simulation Model for A-type Production Plants

A simulation model for A-type production plants is developed using the Goldsim software and is presented in figure 5.1. This model has seven work stations WCA-1, WC3, WCA-4, WCA-5, WCB-2, WCB-3 and WCC-5. This model also involves drum buffer, drum beat, and drum rope. Suppose, in a production process, it is planned to check the quality of materials: Raw-material-1, Raw-material-2, and Raw-material-3, which are to be processed through seven different work stations. The Raw-material-1 is processed through WCA-1, WC3, WCA-4, WCA-5 and then it moves to the final assembly section as Part-A. The Raw-material-2 is processed through WCB-2, WCB-3 and then it moves to the sub-assembly section as Part-B. The Raw-material-3 is processed through WCC-5 and then it moves to the sub-assembly section as Part-C. The semi-finished products consisting of Part-B and Part-C from sub-assembly section and the Part-A are assembled at the final assembly section to produce the final product. The final assembled products are then sent for shipment and throughput. Once the Raw material-1 is processed through WCA1, before reaching CCR, the work station WC3, the capacity constrained resource, the quality of the raw-material is inspected using SSP ( $n_p, c_p$ ). Before the shipment of the finished products, once again the quality of the final product is inspected using SSP ( $n_q, c_q$ ).

#### Example for A-type plant

Let us consider the production process in Lenovo, the computer manufacturing company. The various components of the computer such as keyboard, monitor, mouse, CPU etc., are manufactured in different units. After this, a step by step assembling process takes place at the respective work stations. Suppose using the Raw-material-1, CPU is manufactured in WCA1, power supply parts in WC2, mother board is WC3, cabinets in WCA4 and hard disk in WCA5 respectively. Using Raw-material-2, WCB2 and WCB3 manufactures the mouse and keyboard. Using Raw-material-3, monitor is manufactured in WCC5. Once the parts manufacturing process is completed, the parts are assembled together at assembly section to form the end-product namely the computer. The manufactured parts enter the packaging section for labelling the brand name and packing. The computers are sent for shipment and throughput. The figure 4.2 depicts the throughput model for the A-type production plants. If a production industry reduces the scrap loss, wages, investment, energy, transport, inventory and operating expenses from the total variable cost, then there will be a definite increase in Return on Investment.

#### Construction of SSP and Calculations of ROI

Suppose, the manager of an organization runs the factory on the basis of the TOC. The nature of business is assembly process, and converts the parts coming from three different lines into a single final product. It is assumed that the constraint is in the first line. By fixing the lot size  $N$  as 100, 500, and 1000, for various proportion defective values ( $p$ ), the ROI % have been calculated and presented along with the SSPs with ( $n_p, c_p$ ) and ( $n_q, c_q$ ) in Table-5.1, Table-5.2, and Table-5.3 respectively. Suppose, for a given lot of size 100, corresponding to the desired proportion defective  $p = 0.01$ , it is found from the table 6.1, that the SSP to be used before WC3 is SSP (69,0) and the SSP to be used before shipment of the finished product is SSP (100,0) in order to achieve the ROI as 55.75%. Suppose, for a given lot of size 500, corresponding to the desired proportion defective  $p = 0.05$ , it is found from the table 6.2, that the SSP to be used before WC3 is SSP (500,3) and the SSP to be used before shipment of the finished product is SSP (10,6) in order to achieve the ROI 176.93%. Suppose, for a given lot of size 1000, corresponding to the desired proportion defective  $p =$





**Ravi Sankar and Maheswari**

0.06, it is found from the table 6.3, that the SSP to be used before WC3 is SSP (997,0) and the SSP to be used before shipment of the finished product is SSP (58,7) in order to achieve the ROI as 188.62%.

**CONCLUSION**

In this study, to Single Sampling Plans for manufacturing of production plants for A-type are constructed to maximize the throughput values. The tables having different lot sizes, Single Sampling Plans with ROI for various proportion defective values have been constructed so as to full fill the main aim of this study to reduce the cost, inventory and to increase the profit. This study can be further extended by considering Double sampling plans and the other types of production plants.

**REFERENCES**

1. Blackstone J. H, "Theory of constraints – A status report". *International Journal of Production Research*, 39(6), 1053–1080(2001).
2. Chowdhary M, "Constraint Management: Throughput, operating expense and inventory". New Delhi: Global India Publications(2009).
3. Cox and Schleier, "Theory of constraints hand book. New York" McGraw-Hill (2010)
4. Dettmer, W. H, "Breaking the constraints to world class performance Milwaukee"
5. ASQC press(1998).
6. Goldratt, E. M & Cox, J, "The goal: A process of ongoing improvement).
7. (2nd ed.) Great Barrington" North River Press(1992).
8. Goldratt, E. M., Schragenheim & Ptak. "Necessary but not sufficient. Great
9. Barrington": North River Press(2000).
10. Grubbs, F. E. (1949). "On designing single sampling inspection plans". *The Annals of Mathematical Statistics*, 20(2), 242-256.
11. Gupta, M. C., & Boyd, L. H, "Theory of Constraints: A theory for operations management" *International Journal of Operations & Production Management*, 28(10), 991–1012(2008).
12. Mabin, & Balderstone, "The performance of the theory of constraints methodology: Analysis and discussion of successful TOC applications". *International Journal of Operations & Production Management*, 23(6), 568–595(2003).
13. Oglethorpe, D., & Heron, G, "Testing the theory of constraints in UK local food supply chains ". *International Journal of Operations & Production Management*, 33(10), 1346–1367(2013).
14. Roser, C., Lorentzen, K., & Deuse, J), " Reliable shop floor bottleneck detection for flow lines through process and inventory observations". *The bottleneck walk. Logistic Research*, 8(7), 1–9(2015).
15. Ravi Sankar, S and Maheswari, D, "Theory of Constraints Approach Using Simulation Sampling Inspection for V-type Production Plants " *Aryabhata Journal of Mathematics and Informatics* 14(1), 2394-9309(2022).
16. Soundararajan, V, "Maximum allowable percent defective (MAPD) single sampling inspection by attributes plan", *Journal of Quality Technology*, 7(4), 173-177(1975).
17. Schilling, E.G. and Johnson, L. I, "Tables for the Construction of Matched Single, Double and Multiple Sampling Plans with Applications to MIL-STD-105D" *Journal of Quality Technology*, 12(4), 220-229 (1980).
18. Scheinkopf, L" Thinking for a change Putting the TOC thinking processes to use. APICS Series on Constraints Management" Boca Raton: St Lucie Press(1999).

**Table 1: ROI% using SSP with  $(n_p, c_p), (n_q, c_q)$  for the lot size of 100**

Lot size=100	Constraint				Assembled Product
	$n_p$	$c_p$	$n_q$	$c_q$	ROI %
0.01	69	0	100	0	55.75
0.02	27	0	58	0	55.65





**Ravi Sankar and Maheswari**

0.03	88	2	39	0	55.56
0.04	100	0	100	0	53.18
0.05	100	0	100	0	54.12
0.06	100	0	100	0	51.73
0.07	100	0	100	0	52.11
0.08	100	0	91	1	52.45
0.09	27	9	29	2	51.65
0.1	30	10	66	6	52.49
0.12	20	10	91	0	54.37
0.14	21	10	97	0	54.76
0.16	20	10	96	0	54.88
0.18	86	0	62	4	43.90
0.2	87	0	100	10	43.60

**Table 2: ROI% using SSP with  $(n_p, c_p), (n_q, c_q)$  for the lot size of 500.**

Lotsize 500 P	Constraint				Assembled Product ROI %
	$n_p$	$c_p$	$n_q$	$c_q$	
0.01	166	1	15	4	194.71
0.02	57	4	164	9	192.81
0.03	322	9	30	5	191.89
0.04	500	0	10	4	189.07
0.05	500	3	10	6	176.93
0.06	500	2	10	7	178.65
0.07	405	0	10	2	180.44
0.08	500	3	27	5	182.30
0.09	500	2	500	8	150.37
0.1	106	10	258	6	137.43
0.12	381	4	19	5	166.85
0.14	489	10	10	7	170.46
0.16	379	3	10	9	152.28
0.18	283	0	489	5	100.43
0.2	2	236	7	170	84.09

Lotsize 500 p	Constraint				Assembled Product ROI %
	$n_p$	$c_p$	$n_q$	$c_q$	
0.01	565	5	154	7	204.59
0.02	533	10	21	7	203.10
0.03	189	5	769	4	185.94
0.04	1000	0	10	4	184.77
0.05	213	10	10	7	198.76
0.06	997	0	58	7	188.62
0.07	885	0	10	1	190.66
0.08	914	10	10	2	192.79
0.09	997	1	10	4	195.06
0.1	277	4	33	6	169.65
0.12	718	1	610	1	131.12
0.14	444	3	261	9	127.33
0.16	731	9	662	9	123.64



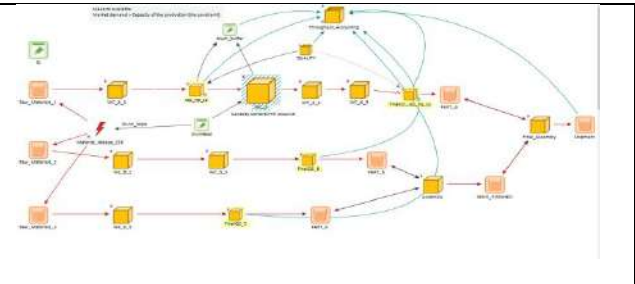


**Ravi Sankar and Maheswari**

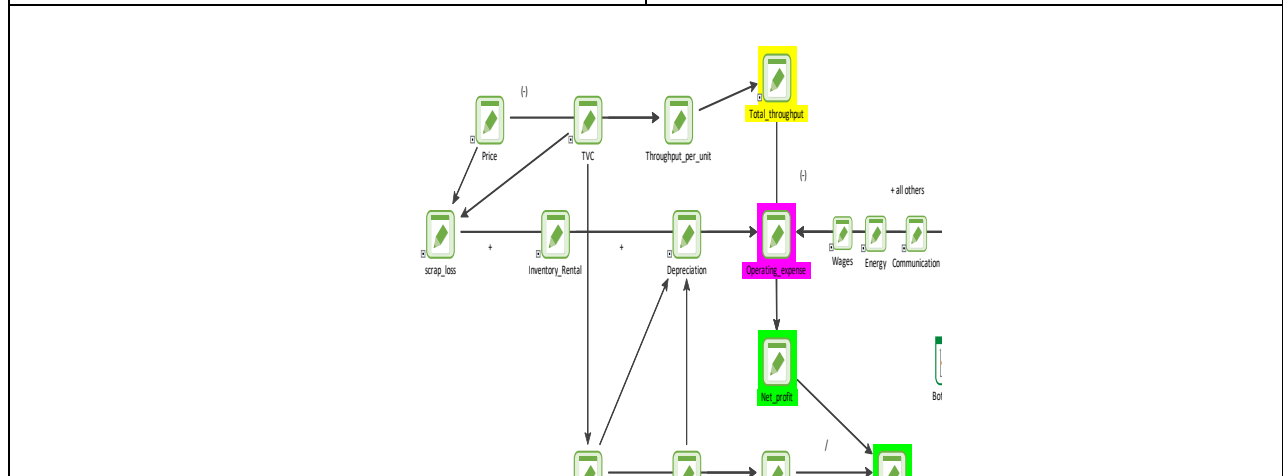
0.18	819	10	25	9	184.80
0.2	242	3	140	2	89.10



**Figure 1: A-type Production Plants**



**Figure 2: Simulation Model for A-type Production Plant**



**Figure 3: Throughput Model for A-type Production Plants**





## A Validated UV Spectrophotometric Method for Raltegravir Potassium in Bulk and Tablet Dosage Form

Sridevi Ranjitha Karanam<sup>1\*</sup>, Sridevi.K<sup>2</sup>, Dilip Kumar.R<sup>2</sup> and Nammi Poojitha<sup>2</sup>

<sup>1</sup>Associate Professor, Department of Pharmaceutical Analysis, Vignan Institute of Pharmaceutical Technology, Visakhapatnam, (Affiliated to The Jawaharlal Nehru Technological University, Gurajada, Vizianagaram), Andhra Pradesh, India.

<sup>2</sup>Student, Department of Pharmaceutical Analysis, Vignan Institute of Pharmaceutical Technology, Visakhapatnam, (Affiliated to The Jawaharlal Nehru Technological University, Gurajada, Vizianagaram), Andhra Pradesh, India.

Received: 24 Jan 2024

Revised: 10 Apr 2024

Accepted: 09 May 2024

### \*Address for Correspondence

**Sridevi Ranjitha Karanam**

Associate Professor,

Department of Pharmaceutical Analysis,

Vignan Institute of Pharmaceutical Technology, Visakhapatnam,

(Affiliated to The Jawaharlal Nehru Technological University,

Gurajada, Vizianagaram), Andhra Pradesh, India.

Email: ranjitha.karanam@gmail.com



This is an Open Access Journal / article distributed under the terms of the **Creative Commons Attribution License** (CC BY-NC-ND 3.0) which permits unrestricted use, distribution, and reproduction in any medium, provided the original work is properly cited. All rights reserved.

### ABSTRACT

An anti-retroviral drug for HIV treatment is raltegravir potassium. Methanol is the basis for a particular and cost-effective UV spectrophotometric technique that has been created. It was demonstrated that you could find the potassium content of raltegravir in both bulk and tablet dosage formulations at a fixed lambda max of 221 nm. The regression equation was determined to be ( $y = 0.0094x + 0.054$ ), with beer limits in the 20–100 µg/mL range showing good correlation ( $R^2 = 0.9996$ ). Raltegravir potassium was determined using this approach with good agreement, and the results were implemented effectively. Linearity, accuracy, precision, robustness, and ruggedness were the ICH recommendations that the method was tested against. The acquired findings demonstrated that the method was suitable for routine analysis of Raltegravir potassium in bulk and tablet dosage form.

**Keywords:** Raltegravir Potassium, UV Spectroscopy, Method Development, Method Validation.

## INTRODUCTION

HIV-1 INSTI, an inhibitor of HIV integrase strand transfer with HIV-1 antiviral efficacy, [9] Raltegravir Potassium is the potassium salt of raltegravir that can be used orally. Raltegravir binds to and inhibits the HIV enzyme integrase, which inserts viral genetic material into the genetic material of infected human cells[10,11]. HIV replication is stopped by integrase inhibition, which prevents HIV DNA from being integrated into the human DNA







Sridevi Ranjitha Karanam *et al.*,

genome. Potassium 4-[[[4-(4-fluorophenyl) methyl] carbamoyl] is its chemical name. [(5-methyl-1,3,4-oxadiazol-2-yl)formamido] -1-methyl-2-[2-(2-yl) propan-2-olate, 6-oxo-1,6-dihydropyrimidin-5. Its molecular weight is 444.4163 g/mol and its formula is  $C_{20}H_{20}FN_6O_5$  [7,8]. It dissolves in water, ethanol (very slightly soluble), acetonitrile (very barely soluble), DMSO (slightly heated), and methanol (slightly heated). In order to stop the viral DNA from integrating into the human genome, raltegravir inhibits HIV integrase. The main metabolic process of raltegravir is glucuronidation [12]. Few raltegravir on RP-HPLC developed methods exist [13–19].

## MATERIALS AND METHODS

**Drug and Chemicals:** The sample is obtained as gift sample from Aurobindo Pharma. Pvt. Ltd. The raltegravir is available in the market under the brand name is Isentress. The solvents are procured from Merck Chemicals. Pvt. Ltd.

### Instrument used

Lab India UV Spectrophotometer with Lab solutions software.

### Preparation of Solutions

#### Preparation of stock solution

To obtain 1000  $\mu\text{g/ml}$  of stock solution, 10 mg of Raltegravir potassium was precisely weighed, transferred to a 10 ml volumetric flask, and then filled to the brim with methanol.

#### Preparation of working stock solution

One millilitre of the sample was collected from the stock solution and put in a ten millilitre volumetric flask. Methanol was added to the sample to get 100  $\mu\text{g/ml}$ .

### Method Development:

Raltegravir potassium working stock solution (100  $\mu\text{g/ml}$ ) was placed in a volumetric flask, and it is shaken for two minutes, and it is scanned at the range between 200–400 nm U.V spectrophotometer. It was determined that 221 nm is the most acceptable wavelength for analyzing with adequate sensitivity against a reagent blank from the absorption spectra.

### Method Validation

#### a) System Suitability

The resolution and repeatability of the absorbance system are measured using system appropriateness to see if they are adequate for analysis.

#### b) Linearity

The recommended concentration of 10 mg of raltegravir potassium was dissolved in 10 ml of methanol. From the stock solution, one millilitre, or 1 ml, of the sample was taken and used to fill a 10-ml volumetric flask. It was found that the UV absorbance of each concentration was comparable.

Plotting peak area versus Raltegravir potassium concentration allowed for the construction of calibration graphs, from which the regression equation was derived. Plotting the calibration graph at various concentrations of 20, 40, 60, 80, and 100  $\mu\text{g/ml}$  is shown in figure 3. The outcomes were displayed in Table 1.

#### c) Precision:

Precision is determined by taking number of measurements in which they are under the same analytical conditions [2]. Then we have to measure the closeness of the data values to each other. The components of precision, i.e., repeatability (Intraday precision), intermediate precision and system precision in accordance with ICH guidelines, were determined as follows:





Sridevi Ranjitha Karanam *et al.*,

#### Intermediate precision (Inter day Precision)

The intermediate precision was assessed by injecting a standard solution of Raltegravir potassium at the same concentration into six subjects on successive days. % RSD was then computed. Table 2 displayed the results.

#### Repeatability (Intraday Precision)

By repeatedly injecting (n=5) a standard solution of Raltegravir potassium at various time intervals on the same day, the instrument's precision was verified, and the percentage RSD was computed. Table 3 displayed the results. The 6 samples of same concentration were injected each time according to the conditions mentioned and absorbance in UV was noted.

#### d) Accuracy

With the aid of recovery technique an external standard addition method the method's accuracy was determined [3]. The pre-analyzed sample received additions of the known standard quantity at three distinct levels: 80%, 100%, and 120%. Three copies of each determination were made. The results were displayed in Tables 4.

#### e) Robustness

Minimal chromatographic conditions adjustments, such as changing the mobile phase's composition, wavelength, and flow rate to 220 nm and 222 nm were used to evaluate the technique's resilience. [4]. The chromatograms lack of discernible fluctuations demonstrated the dependability of the UV process. The results were shown in the 5.

#### f) Ruggedness

According to the USP, toughness refers to the degree of reproducibility of results achieved under a variety of circumstances, including different laboratories, analysts, instruments, environmental conditions, operators, and materials, like this sample, which was handled by various analysts [5]. The reproducibility of test results from lab to lab and analyst to analyst under typical, expected operational settings is measured by ruggedness. The results were displayed in Table 6.

#### g) Sensitivity

The limit of detection, or LOD, is the lowest concentration of an analyte that an analytical method can reliably differentiate from background values. The limit of quantification (LOQ) is the lowest concentration of the standard curve that can be measured with a satisfactory level of precision, accuracy, and variability [6]. The LOD and LOQ were calculated from a linear curve using formulae. The outcomes were shown in Table 7.

## CONCLUSION

The development and validation of a UV spectrophotometric method utilizing methanol have established a robust and reliable technique for assessing the potassium content of raltegravir, an essential antiretroviral drug for HIV treatment. The method's adherence to stringent ICH recommendations, coupled with the demonstrated linearity, accuracy, precision, robustness, and ruggedness, substantiates its efficacy. Lambda max was found to be 221 nm. The obtained regression equation and high correlation ( $R^2 = 0.9996$ ) within the 20–100  $\mu\text{g/mL}$  range underscore its precision and suitability for quantifying raltegravir potassium in bulk and tablet formulations. Its successful application signifies its potential as a routine analytical tool, offering a cost-effective and dependable means to ensure the quality and consistency of raltegravir potassium in HIV treatment formulations.

## ACKNOWLEDGEMENT

The authors would like to thank Dr. Y. Srinivasa Rao, Professor & Principal of Vignan Institute of Pharmaceutical Technology for continuous support to carry out this research.



Sridevi Ranjitha Karanam *et al.*,**REFERENCES**

1. P.D. Sethi, HPLC Quantitative Analysis Pharmaceutical Formulations, CBS Publishers and Distributors, New Delhi, 2001.
2. S. Ashutoshkar, Pharmaceutical drug Analysis 2<sup>nd</sup> Edn, New Age International Private Limited Publishers, 2005.
3. H. Beckett and J.B. Stenlake, Practical Pharmaceutical Chemistry, 4<sup>th</sup> Edn, C. B. S. Publishers and Distributors, New Delhi.
4. H.H. Williard, L.L. Merit, F.A. Dean, F.A. Settle, Instrumental Method of Analysis, 6<sup>th</sup> Edition C.B.S. Publishers and Distributors, New Delhi.
5. Skoog, D. A., F.J. Holler, and S.R. Crouch. 2007. Principles of Instrumental Analysis, 6<sup>th</sup> Edition. Thomson Publishing USA
6. L.R. Snyder, J.J. Kirkland, and J. W. Dolan, Introduction to Modern Liquid Chromatography, John Wiley & Sons, New York, 2009.
7. Raltegravir potassium | C20H20FKN6O5 | CID 23668479 - PubChem (nih.gov)
8. Gulab D. Identification, Synthesis, and Strategy For Minimization of Potential Impurities Observed In Raltegravir Potassium Drug Substance. Organic Process Research & Development. Volume 16. Issue 8. Pages 1422-1429. 2012.
9. Raltegravir Oral: Uses, Side Effects, Interactions, Pictures, Warnings & Dosing - WebMD
10. Dario Cattaneo. Comparison of the In Vivo Pharmacokinetics and In Vitro Dissolution of Raltegravir in HIV Patients Receiving the Drug by Swallowing or by Chewing. ASM Journals. Antimicrobial Agents and Chemotherapy. Vol. 56, No.12 DOI: <https://doi.org/10.1128/aac.00942-12>.
11. Raltegravir: MedlinePlus Drug Information
12. Raltegravir: Uses, Interactions, Mechanism of Action | DrugBank Online
13. Rambabu Kurchi, K. Balmurali Krishna and Sambasiva Rao. New RP - HPLC Method Development and validation for Analysis of Antiviral drug Raltegravir. Journal of Research in Pharmaceutical and Biomedical Sciences. 2011; Corpus ID: 97688994
14. T. Sudha and P. Shanmuga sundram. Development and Validation of RP-HPLC and HPTLC Chromatographic Methods of Analysis for the Quantitative Estimation of Raltegravir Potassium in Pharmaceutical Dosage Form. Research Journal of Pharmacy and Technology. Research J. Pharm. and Tech. 4(11): Nov. 2011; Page 1746-1750.
15. Sonam Patel, Krishnaveni Nagappan, Gouru Santhosh Reddy, Gullapalli Kowmudi.
16. Quantitative Reverse-phase High-performance Liquid Chromatographic Method for the Quantification of Raltegravir Potassium in Bulk and Dosage Forms. J Young Pharm, 2019; 11(3):274-278. DOI: 10.5530/jyp.2019.11.55
17. A. Lakshmana Rao and MS. Raghu Ram. Validated Reverse phase HPLC method for Determination of Raltegravir in pharmaceutical preparations International journal of research in pharmacy and chemistry, IJRPC 2012, 2(1). ISSN: 2231-2781
18. T. Sudha, T. Raghupathi. Reverse Phase-High Performance Liquid Chromatography and Ultra Violet Spectrophotometric Method for the Estimation of Raltegravir Potassium in Bulk and in Tablet Dosage form. Global Journal of Medical research. Volume 11 Issue 2 Version 1.0 July 2011. ISSN: 0975-5888
19. Sonam Patel, Krishnaveni Nagappan, Gouru Santhosh Reddy, Gullapalli Kowmudi.
20. Quantitative Reverse-phase High-performance Liquid Chromatographic Method for the Quantification of Raltegravir Potassium in Bulk and Dosage Forms. J Young Pharm, 2019; 11(3):274-278.
21. K. Vijaya Sri, S. Ravinderreddy, K. Suresh. Rapid RP-HPLC Method Development and Validation for Analysis of Raltegravir in Bulk and Pharmaceutical Dosage Form. Asian Journal of Research in Chemistry in 2015; 8(5) ; Page 335-339. doi: 10.5958/0974-4150.2015.00055.3



Sridevi Ranjitha Karanam *et al.*,**Table 1: Calibration curve data for Raltegravir potassium**

S.No	Raltegravir potassium	
	Conc. ( $\mu\text{g/ml}$ )	Absorbance
1.	20	0.2377
2.	40	0.4303
3.	60	0.6449
4.	80	0.8111
5.	100	0.9830

**Table 2: Precision data for Raltegravir potassium**

S.No	Day 1	Day 2	Day 3	Absorbance
	Conc. ( $\mu\text{g/ml}$ )	Absorbance	Absorbance	
1.	60	0.6888	0.6384	0.6275
2.	60	0.6796	0.6519	0.6372
3.	60	0.6881	0.6328	0.6184
4.	60	0.6559	0.6479	0.6317
5.	60	0.6814	0.6582	0.6214
6.	60	0.6685	0.6431	0.6353
Mean		0.67705	0.645383	0.62893
S.D		0.012695	0.009223	0.0075
%RSD		1.8%	1.4%	1.2%

**Table 3: Precision data for Raltegravir potassium**

S.No	Conc. ( $\mu\text{g/ml}$ )	Time interval 1	Time interval 2	Time interval 3
		Absorbance	Absorbance	Absorbance
1.	60	0.6888	0.6417	0.6128
2.	60	0.6796	0.6508	0.6147
3.	60	0.6881	0.6428	0.6239
4.	60	0.6559	0.6474	0.6190
5.	60	0.6814	0.6628	0.6241
6.	60	0.6685	0.6332	0.6297
Mean		0.67705	0.64645	0.6202
S.D		0.012695	0.0099	0.0064
%RSD		1.8%	1.5%	1.0%

**Table 4 : Recovery studies for Raltegravir potassium**

Drug	Spike level(%)	Amount taken( $\mu\text{g/ml}$ )	Amount found( $\mu\text{g/ml}$ )	Percent recovery(%w/w)	Stastical Parameters
Raltegravir potassium	80	32	31.8	99.3%	Mean:99.3% SD : 0.003 %RSD: 0.3%
	80	32	31.7	99.0%	
	80	32	31.9	99.6%	
	100	40	39.8	99.5%	Mean:99.4% SD : 0.0014 %RSD: 0.14%
	100	40	39.7	99.25%	
	100	40	39.8	99.5%	
	120	48	47.8	99.5%	Mean:99.5% SD : 0.0011 %RSD: 0.11%
	120	48	47.9	99.7%	
	120	48	47.8	99.5%	





Sridevi Ranjitha Karanam *et al.*,

**Table 5: Robustness studies of Raltegravir potassium**

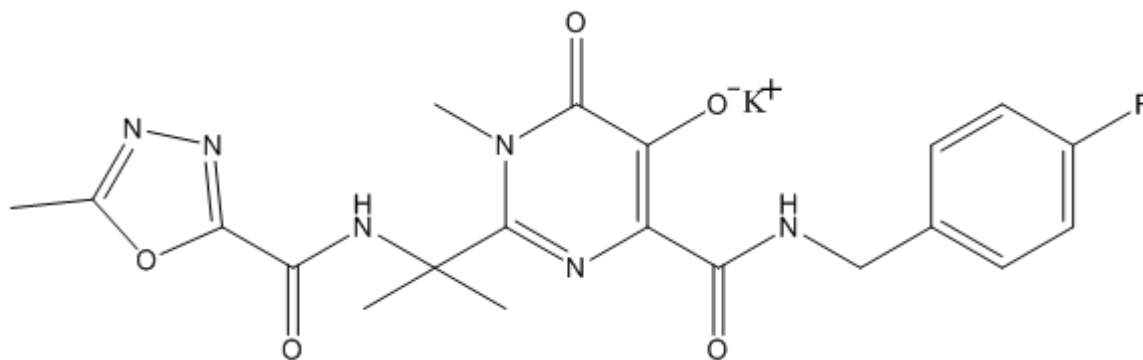
Modification	Raltegravir potassium	
Wavelength	220nm	222nm
	0.6459	0.6376
	0.6548	0.6487
	0.6325	0.6369
	0.6254	0.6589
	0.6516	0.6273
	0.6574	0.6496
Mean	0.6446	0.6431
%RSD	2.0%	1.7%

**Table 6: Ruggedness studies of Raltegravir potassium**

Modification	Raltegravir potassium	
Analyst	Analyst 1	Analyst 2
	0.6479	0.6319
	0.6530	0.6280
	0.6319	0.6432
	0.6582	0.6486
	0.6498	0.6274
	0.6366	0.6180
Mean	0.6462	0.63285
%RSD	1.5%	1.7%

**Table 7 : LOD and LOQ data for Raltegravir potassium**

Drug	LOD( $\mu\text{g/ml}$ )	LOQ ( $\mu\text{g/ml}$ )
Raltegravir potassium	0.0762	0.231



**Fig. 1: Molecular structure of Raltegravir potassium**





Sridevi Ranjitha Karanam et al.,

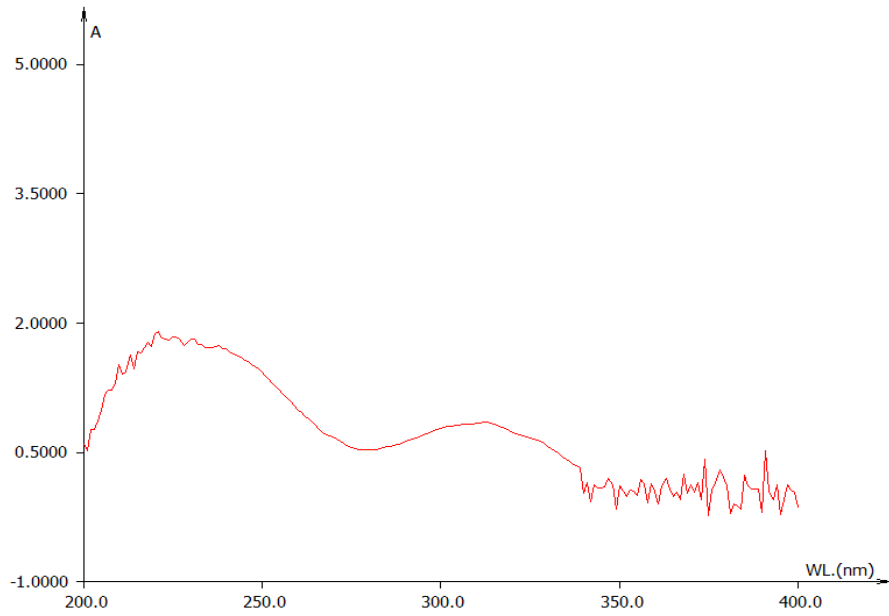


Fig.2: Absorption spectra of Raltegravir potassium

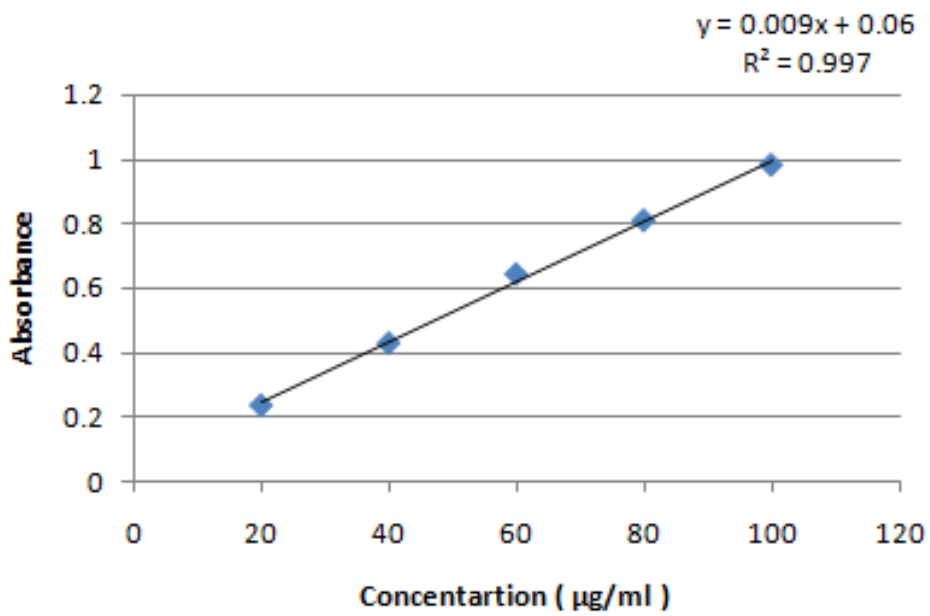


Fig.3: Calibration curve data for Raltegravir potassium





# Machine Learning Algorithms in Optimizing Production Inventory Model

M. Renee Miriam<sup>1</sup> and Nivetha Martin<sup>2\*</sup>

<sup>1</sup>Ph.D. Research Scholar, Department of Mathematics, Madurai Kamaraj University, Madurai, Tamil Nadu, India.

<sup>2</sup>Assistant Professor, Department of Mathematics, Arul Anandar College (Autonomous) Karumathur, (Affiliated to Madurai Kamaraj University) Madurai, Tamil Nadu, India.

Received: 22 Jan 2024

Revised: 09 Feb 2024

Accepted: 27 Apr 2024

## \*Address for Correspondence

### Nivetha Martin

Assistant Professor,  
Department of Mathematics,  
Arul Anandar College (Autonomous)  
Karumathur, (Affiliated to Madurai Kamaraj University)  
Madurai, Tamil Nadu, India.  
Email: nivetha.martin710@gmail.com



This is an Open Access Journal / article distributed under the terms of the **Creative Commons Attribution License** (CC BY-NC-ND 3.0) which permits unrestricted use, distribution, and reproduction in any medium, provided the original work is properly cited. All rights reserved.

## ABSTRACT

The economic production quantity is highly influenced by many factors and significant parameters are to be considered to find the optimal quantity produced by the production sectors. Artificial Neural Network (ANN) is a machine learning algorithm used in this paper to enhance the efficiency of the production system of a manufacturing firm. The architecture of ANN with substantial input parameters and the production order quantity as an output parameter with a suitable algorithm in MATLAB is modeled to make optimal predictions of production order quantity. In this research work, the production setup of Industry 4.0 is considered, and the respective demand and cost parameters are taken as the model's inputs. The ANN model is subjected to various training algorithms and transfer functions to create a suitable prediction of optimal production order size.

**Keywords:** Machine learning, ANN, production order quantity, optimization

## INTRODUCTION

Inventory modeling of obtaining optimal order quantity in the context of Industry 4.0 has recently gained momentum as the core elements of digitalized inventory are forming an integral part of the production system. Industry 4.0 encompasses a production system embedded with modern machinery and advanced technology that eases product design, production, and distribution with additional costs. The word 'smart' is a twin word of



**Renee Miriam and Nivetha Martin**

digitalization, and one of the outcomes of integrating the features of Industry 4.0 into a production system is the generation of smart products at optimal times. Researchers have developed smart production inventory models considering the significant attributes of Industry 4.0. To mention a few, Christian Decker et al. developed a smart supply chain model [13]. Andrew Kusiak described the implications of a smart manufacturing system [14]. Sameer et al. presented industry 4.0-based inventory models for the production sectors at a small scale [15]. Zhuang et al. proposed a technology-assisted smart production system [16]. Trabucco et al. constructed a model with a digitalized stock chain [17]. Souvik et al. employed the internet of things in inventory management [18]. Poti et al. built up an inventory model for smart items [19]. Kamble et al. evolved a smart supply chain inventory model [20]. Iqra Asghar et al. proposed a smart EPQ model under a stochastic environment [21]. Nivetha et al. developed a smart production inventory model under neutrosophic environment [22]. In all of the above presented research works on inventory modeling the optimal production quantity is determined using human interference with simulated secondary data. Followed by these works few of the researchers have employed machine learning algorithms especially artificial neural networks (ANN) to make demand forecasting and predictions.

ANN are the neural networks that mimic the biological neural networks. Every ANN's basic design consists of three layers—the input, hidden, and output layers—along with various learning methods to provide the best outcomes. Ali et al. applied feed-forward back propagation algorithm to forecast raw material optimum level [1]. Kumar et al. used ANN training methods of TRAINLM, TRAINGD, TRAINGDA & TRAINCGF to forecast demand [2]. Jaipuria et al. employed Discrete wavelet transforms analysis ANN to forecast demand [3]. Sustrova used ANN with TRAINGDX as training function and TANSIG as transfer function [4][5]. Jurczyk et al. formulated three layered to forecast demand at a distribution enterprise [6]. Taghizadeh applied Big Data techniques and ANN to make predictions on weather sensitive products [7]. Okwu et al. employed ANN feed-forward, back propagation learning, sigmoid transfer function in cost optimization [8]. Gao et al. made use of Genetic algorithm and backpropagation neural network in making inventory prediction for railway logistic park [9]. Dey et al. applied ANN to find the optimal order quantity [10]. Ibrahim et al. used ANN with transfer functions for seasonal time series [11]. Aktepe et al. used ANN in association with support vector machine in demand forecasting [12]. From the above stated literature the following research gaps are identified, it is observed that ANN is predominantly applied with both forward and backward algorithms and different transfer functions to make optimal predictions of only order quantity and demand. Also the input cost parameters subjected to only the conventional production system is considered. To bridge these gaps, in this paper an ANN prediction model of production order quantity considering the new set of cost parameters subjected to industry 4.0 is developed using MATLAB software. The rest of the paper is organized as follows: section 2 presents a brief description of ANN, section 3 comprises the newly developed ANN model, section 4 discusses the results and the last section concludes the work.

**ARTIFICIAL NEURAL NETWORK**

The goal of a neural network is to uncover hidden connections in a set of data by integrating algorithms in a way that reflects how the human brain processes information. Neural networks may deliver the best results since they can adapt to changing inputs. The input layer neurons comprise the first layer. These neurons provide information to deeper layers, which subsequently send the information for the subsequent output to the output layer at the end. Each inner layer is concealed and is made up of units that convert the information that is sent from one layer to the next in an adaptive manner. For the ANN to comprehend more complicated things, each layer functions as both an output and input layer. These inner layers are collectively referred to as the neural layer. The neural layer's units weigh the collected data in accordance with the ANN's internal system to learn more about it. Units can produce altered results using these rules, and the output is subsequently sent to the following layer. Back propagation is a technique used by an extra set of learning rules that allows the ANN to correct its output results by taking errors into consideration. In the supervised training phase, information is transmitted backward by back propagation each time the output is classified as an error. Depending on how much each weight contributed to the inaccuracy, it is changed accordingly. To account for the discrepancy between the anticipated outcome and the actual one, the error is utilized to adjust the weight of ANN's unit links. The ANN will eventually "learn" how to reduce the likelihood of mistakes and undesirable outcomes. To train an artificial neural network, one must select from a set of permitted models and







### Renee Miriam and Nivetha Martin

related techniques. One of the well-known benefits of an ANN is that it can really learn from viewing data sets. An ANN offers several other benefits as well. When establishing computing functions or distributions, these tools can be used to estimate the most perfect and economical ways to arrive at solutions. ANN generates solutions using data samples as opposed to whole data sets, which saves both time and money. To improve current data analysis methods, ANNs are thought of as relatively straightforward mathematical models.

#### ANN MODEL DEVELOPMENT

The objective of this section is to design an artificial neural network with optimal architecture for determining the optimal production quantity subjected to industry 4.0. The production order amount is determined using ANN utilizing the input parameters of demand rate, operating costs, production costs, machinery maintenance costs, digital costs, and quality maintenance costs. The sample data is provided in Table 1. The MathWorks MATLAB software is used to create the ANN. Fig. 1 portrays the input and the output parameters of the desired ANN.

When building a neural network model, the following procedures must be followed: gathering input, output, and sample datasets; designing; training; and validating the neural network.

#### Normalization of the Data

Data must be converted into input-output patterns before being used with a neural network. An input and a respective target vector are used to create each pattern. The standardization was performed with the help of the following equation.

$$X_i = \frac{x_i - \min(x_i)}{\max(x_i) - \min(x_i)}$$

Where  $x_i$  represents a particular value of the parameter in the input vector,  $\min(x_i)$  represents the min value of the parameter in which  $x_i$  is taken and  $\max(x_i)$  represents the max value of the parameter in which  $x_i$  is taken. The constructed ANN employs 70% of the data for training, 15% for testing, and 15% for validation. A set of input is given for which Optimum Production Quantity is to be determined is fed and the output is obtained from the network. Neural Network is developed using MATLAB's Neural Network Toolbox. Data gathered from both primary and secondary sources is used to train an ANN.

- **Network type:** feed-forward backprop
- **Training function :** train lm / train dga
- **Adaption learning function :** learn gdm / learn gd
- **Performance function :** mse
- **Transfer function :** tansig / pure lin

The data after normalizing is subjected to the mentioned neural network type and functions of training transfer, learning and performance. The optimal ANN architecture is determined by considering the following cases by taking the number of neurons as 6, 8, 10 and 12 respectively. The graphical results obtained using adaption learning function LEARNNGDM, transfer function TANSIG and training functions TRAINLM & TRAINGDA are presented in Table 3.2. The graphical results obtained using adaption learning function LEARNNGDM, transfer function PURELIN and training functions TRAINLM & TRAINGDA are presented in Table 3. From the tabulated graphical results, the most suitable ANN architecture is obtained and discussed in section 4.

## RESULTS AND DISCUSSION

The data samples provided in Microsoft Excel are fed in MATLAB and subjected to training, testing and validating through feed-forward back propagation network by changing the number of neurons and through various training and transfer functions. Table 4 and 5 represent the output obtained by using TANSIG and PURELIN transfer functions respectively.





### Renee Miriam and Nivetha Martin

#### Best solution for our input

TRAINING FUNCTION: TRAINLM

ADAPTION LEARNING FUNCTION: LEARNGDM

TRANSFER FUNCTION: TANSIG

NEURONS: 8

6-8-1 is the most suitable neural network with highest coefficient of determination ( $R^2$ ) and lowest mean squared error. Fig 4.1- 4.4 represents the graphs of the Optimum Neural Network.

Sample Input given to this network to be predicted: [0.89; 0.23; 0.652; 0.954; 0.145; 0.985] Output from the network: 0.31559. Table 4.3 shows the summary of Optimal Neural network.

#### TRAINING PARAMETERS

MAXIMUM NUMBER OF TRAINING ECHOES: 1000

MAXIMUM TRAINING TIME: INFINITE

MINIMUM TRAINING GRADIENT: 1e-07

MAXIMUM FAIL: 6

MAXIMUM PERFORMANCE VALUE: 0

## CONCLUSION

This research work uses an artificial neural network to forecast the ideal production quantity using Matlab from MathWorks to implement the model. Artificial neural networks use input factors including operation costs, production costs, machinery maintenance costs, digital costs, quality maintenance costs, and demand to assess and learn from the results. The best production order size is predicted using the ANN architecture with feed forward back propagation and training functions like trainlm, traingda, learnng adaptation learning function, and transfer functions like tansig, purelin. The neural network with the highest coefficient of determination ( $R^2$ ) and lowest mean squared error is determined to be the architecture 6-8-1 using trainlm, learnngdm and tansig functions. For eco-conscious production models, a similar architecture may be used to forecast production orders. The model can also be extended to include notions for deterioration, shortages, and trade credit policies.

## REFERENCES

1. S.M. Ali, S.K. Paul, K. Ahsan and A. Azeem, "Forecasting of optimum raw material inventory level using artificial neural network", *International Journal of Operations and Quantitative Management*, vol. 17, no. 4, pp. 333-348, 2011.
2. P. Kumar, M. Herbert, S. Rao, "Demand forecasting using artificial neural network based on different learning methods: Comparative analysis", *International journal for research in applied science and engineering technology*, vol. 2, no. 4, pp. 364-374, 2014.
3. S. Jaipuria, S.S. Mahapatra, "An improved demand forecasting method to reduce bullwhip effect in supply chains", *Expert Systems with Applications*, vol. 41, no. 5, pp. 2395-2408, 2014.
4. T. Sustrova, "A suitable artificial intelligence model for inventory level optimization", *Trends Economics and Management*, vol. 10, no. 25, pp. 48-55, 2016.
5. T. Sustrova, "An Artificial Neural Network Model for a Wholesale Company's Order-Cycle Management", *International Journal of Engineering Business Management*, vol. 8, p. 2, 2016. <https://doi.org/10.5772/63727>
6. K. Jurczyk, K. Gdowska, J. Mikulik and W. Wozniak, "Demand Forecasting with the Usage of Artificial Neural Networks on the Example of Distribution Enterprise", *In Int. Conf. on Industrial Logistics ICIL*, 2016.
7. E. Taghizadeh, "Utilizing artificial neural networks to predict demand for weather-sensitive products at retail stores", 2017.





**Renee Miriam and Nivetha Martin**

8. M.O. Okwu, B.U. Oreko, S. Okiy, A.C. Uzorh, O. Oguoma. "Artificial neural network model for cost optimization in a dual-source multi-destination outbound system", *Cogent Engineering*, vol. 5, no. 1, p. 1447774, 2018.
9. L. Gao, H. Dou, "Inventory management of railway logistics park based on artificial neural network", *Journal Européen des Systèmes Automatisés*, vol. 53, no. 5, pp. 715-723, 2020.
10. S. Dey, D. Ghose, "Artificial Neural Network: An Answer to Right Order Quantity", *In Proceedings of the Global AI Congress 2019*, pp. 529-533, 2020.
11. C.S. Ibrahima, J. Xue, T. Gueye, "Inventory management and demand forecasting Improvement of a forecasting model based on artificial neural networks", *Journal of Management Science & Engineering research*, vol. 4, no. 2, 2021.
12. A. Aktepe, E. Yanik and S. Ersöz, "Demand forecasting application with regression and artificial intelligence methods in a construction machinery company", *Journal of Intelligent Manufacturing*, vol. 32, no. 6, pp. 1587-1604, 2021.
13. C. Decker, M. Berchtold, W.F. Chaves, M. Beigl, D. Roehr, T. Riedel, ... and D. Herzig, "Cost-benefit model for smart items in the supply chain", *In The internet of things*, pp. 155-172. 2008.
14. A. Kusiak, "Smart manufacturing", *International Journal of Production Research*, vol. 56, no. (1-2), pp. 508-517, 2018.
15. S. Mittal, M.A Khan, D. Romero and T.Wuest, "A critical review of smart manufacturing & Industry 4.0 maturity models: Implications for small and medium-sized enterprises (SMEs)", *Journal of manufacturing systems*, vol. 49, pp. 194-214, 2018.
16. C. Zhuang, J. Liu and H. Xiong, "Digital twin-based smart production management and control framework for the complex product assembly shop-floor", *The international journal of advanced manufacturing technology*, vol. 96, no. 1, pp. 1149-1163, 2018.
17. M. Trabucco and P. De Giovanni, "Achieving Resilience and Business Sustainability during COVID-19: The Role of Lean Supply Chain Practices and Digitalization", *Sustainability*, vol. 13, no. 22, p. 12369, 2021.
18. S. Paul, A. Chatterjee and D. Guha, "Study of smart inventory management system based on the internet of things (IOT)", *International Journal on Recent Trends in Business and Tourism (IJRTBT)*, vol. 3, no. 3, pp. 27-34, 2019.
19. P. Chaopaisarn and M. Woschank, "Requirement analysis for SMART supply chain management for SMEs", *In Proceedings of the International Conference on Industrial Engineering and Operations Management Bangkok*, pp. 3715-3725, 2019.
20. S.S. Kamble, A. Gunasekaran, A. Ghadge and R. Raut, "A performance measurement system for industry 4.0 enabled smart manufacturing system in SMMES-A review and empirical investigation", *International journal of production economics*, vol. 229, p. 107853, 2020.
21. I. Asghar and J.S. Kim, "An automated smart EPQ-based inventory model for technology-dependent products under stochastic failure and repair rate", *Symmetry*, vol. 12, no. 3, p. 388, 2020.
22. N. Martin, M.K. Mayan and F. Smarandache, "Neutrosophic Optimization of Industry 4.0 Production Inventory Model", *Infinite Study*, 2020.

**Table 1: Sample Data**

Demand	Operating Expenses	Production Cost	Machinery Maintenance Cost	Digital Costs	Quality Sustenance Costs	Production Order Quantity
57858	190	162	245	108	237	16082.91
56185	11	81	171	76	186	11603.62
80050	117	14	195	144	221	23548.5
71474	49	174	131	105	259	18968.41
76793	188	61	150	14	25	17025.64





Renee Miriam and Nivetha Martin

Table 2: Graphical Results of LEARNGDM, TANSIG, TRAINLM & TRAINGDA

Number of Neurons	LEARNGDM & TANSIG																																													
	TRAINLM	TRAINGDA																																												
6	<p>Neural Network</p> <p>Algorithms                      Data Division: Random (dividerand)                      Training: Levenberg-Marquardt (trainlm)                      Performance: Mean Squared Error (mse)                      Calculations: MATLAB</p> <p>Progress</p> <table border="1"> <tr> <td>Epoch:</td> <td>0</td> <td>6 iterations</td> <td>1000</td> </tr> <tr> <td>Time:</td> <td></td> <td>0:00:00</td> <td></td> </tr> <tr> <td>Performance:</td> <td>4.21e-05</td> <td>1.00e-05</td> <td>0.00</td> </tr> <tr> <td>Gradient:</td> <td>0.00114</td> <td>1.25e-05</td> <td>1.00e-07</td> </tr> <tr> <td>Mu:</td> <td>0.00100</td> <td>1.00e-06</td> <td>1.00e+10</td> </tr> <tr> <td>Validation Checks:</td> <td>0</td> <td>6</td> <td>6</td> </tr> </table>	Epoch:	0	6 iterations	1000	Time:		0:00:00		Performance:	4.21e-05	1.00e-05	0.00	Gradient:	0.00114	1.25e-05	1.00e-07	Mu:	0.00100	1.00e-06	1.00e+10	Validation Checks:	0	6	6	<p>Neural Network</p> <p>Algorithms                      Data Division: Random (dividerand)                      Training: Gradient Descent with Adaptive Learning Rate (traingda)                      Performance: Mean Squared Error (mse)                      Calculations: MEX</p> <p>Progress</p> <table border="1"> <tr> <td>Epoch:</td> <td>0</td> <td>6 iterations</td> <td>1000</td> </tr> <tr> <td>Time:</td> <td></td> <td>0:00:00</td> <td></td> </tr> <tr> <td>Performance:</td> <td>0.000865</td> <td>0.000364</td> <td>0.00</td> </tr> <tr> <td>Gradient:</td> <td>0.00305</td> <td>0.00104</td> <td>1.00e-05</td> </tr> <tr> <td>Validation Checks:</td> <td>0</td> <td>6</td> <td>6</td> </tr> </table>	Epoch:	0	6 iterations	1000	Time:		0:00:00		Performance:	0.000865	0.000364	0.00	Gradient:	0.00305	0.00104	1.00e-05	Validation Checks:	0	6	6
Epoch:	0	6 iterations	1000																																											
Time:		0:00:00																																												
Performance:	4.21e-05	1.00e-05	0.00																																											
Gradient:	0.00114	1.25e-05	1.00e-07																																											
Mu:	0.00100	1.00e-06	1.00e+10																																											
Validation Checks:	0	6	6																																											
Epoch:	0	6 iterations	1000																																											
Time:		0:00:00																																												
Performance:	0.000865	0.000364	0.00																																											
Gradient:	0.00305	0.00104	1.00e-05																																											
Validation Checks:	0	6	6																																											
8	<p>Neural Network</p> <p>Algorithms                      Data Division: Random (dividerand)                      Training: Levenberg-Marquardt (trainlm)                      Performance: Mean Squared Error (mse)                      Calculations: MATLAB</p> <p>Progress</p> <table border="1"> <tr> <td>Epoch:</td> <td>0</td> <td>6 iterations</td> <td>1000</td> </tr> <tr> <td>Time:</td> <td></td> <td>0:00:00</td> <td></td> </tr> <tr> <td>Performance:</td> <td>4.87e-05</td> <td>3.19e-06</td> <td>0.00</td> </tr> <tr> <td>Gradient:</td> <td>0.00160</td> <td>0.00021</td> <td>1.00e-07</td> </tr> <tr> <td>Mu:</td> <td>0.00100</td> <td>1.00e-06</td> <td>1.00e+10</td> </tr> <tr> <td>Validation Checks:</td> <td>0</td> <td>6</td> <td>6</td> </tr> </table>	Epoch:	0	6 iterations	1000	Time:		0:00:00		Performance:	4.87e-05	3.19e-06	0.00	Gradient:	0.00160	0.00021	1.00e-07	Mu:	0.00100	1.00e-06	1.00e+10	Validation Checks:	0	6	6	<p>Neural Network</p> <p>Algorithms                      Data Division: Random (dividerand)                      Training: Gradient Descent with Adaptive Learning Rate (traingda)                      Performance: Mean Squared Error (mse)                      Calculations: MEX</p> <p>Progress</p> <table border="1"> <tr> <td>Epoch:</td> <td>0</td> <td>6 iterations</td> <td>1000</td> </tr> <tr> <td>Time:</td> <td></td> <td>0:00:01</td> <td></td> </tr> <tr> <td>Performance:</td> <td>0.00369</td> <td>0.00369</td> <td>0.00</td> </tr> <tr> <td>Gradient:</td> <td>0.00831</td> <td>0.00924</td> <td>1.00e-05</td> </tr> <tr> <td>Validation Checks:</td> <td>0</td> <td>6</td> <td>6</td> </tr> </table>	Epoch:	0	6 iterations	1000	Time:		0:00:01		Performance:	0.00369	0.00369	0.00	Gradient:	0.00831	0.00924	1.00e-05	Validation Checks:	0	6	6
Epoch:	0	6 iterations	1000																																											
Time:		0:00:00																																												
Performance:	4.87e-05	3.19e-06	0.00																																											
Gradient:	0.00160	0.00021	1.00e-07																																											
Mu:	0.00100	1.00e-06	1.00e+10																																											
Validation Checks:	0	6	6																																											
Epoch:	0	6 iterations	1000																																											
Time:		0:00:01																																												
Performance:	0.00369	0.00369	0.00																																											
Gradient:	0.00831	0.00924	1.00e-05																																											
Validation Checks:	0	6	6																																											
10	<p>Neural Network</p> <p>Algorithms                      Data Division: Random (dividerand)                      Training: Levenberg-Marquardt (trainlm)                      Performance: Mean Squared Error (mse)                      Calculations: MATLAB</p> <p>Progress</p> <table border="1"> <tr> <td>Epoch:</td> <td>0</td> <td>6 iterations</td> <td>1000</td> </tr> <tr> <td>Time:</td> <td></td> <td>0:00:00</td> <td></td> </tr> <tr> <td>Performance:</td> <td>0.000128</td> <td>1.07e-05</td> <td>0.00</td> </tr> <tr> <td>Gradient:</td> <td>0.00254</td> <td>7.50e-05</td> <td>1.00e-07</td> </tr> <tr> <td>Mu:</td> <td>0.00100</td> <td>1.00e-06</td> <td>1.00e+10</td> </tr> <tr> <td>Validation Checks:</td> <td>0</td> <td>6</td> <td>6</td> </tr> </table>	Epoch:	0	6 iterations	1000	Time:		0:00:00		Performance:	0.000128	1.07e-05	0.00	Gradient:	0.00254	7.50e-05	1.00e-07	Mu:	0.00100	1.00e-06	1.00e+10	Validation Checks:	0	6	6	<p>Neural Network</p> <p>Algorithms                      Data Division: Random (dividerand)                      Training: Gradient Descent with Adaptive Learning Rate (traingda)                      Performance: Mean Squared Error (mse)                      Calculations: MEX</p> <p>Progress</p> <table border="1"> <tr> <td>Epoch:</td> <td>0</td> <td>6 iterations</td> <td>1000</td> </tr> <tr> <td>Time:</td> <td></td> <td>0:00:00</td> <td></td> </tr> <tr> <td>Performance:</td> <td>0.00467</td> <td>0.00467</td> <td>0.00</td> </tr> <tr> <td>Gradient:</td> <td>0.00944</td> <td>0.00941</td> <td>1.00e-05</td> </tr> <tr> <td>Validation Checks:</td> <td>0</td> <td>6</td> <td>6</td> </tr> </table>	Epoch:	0	6 iterations	1000	Time:		0:00:00		Performance:	0.00467	0.00467	0.00	Gradient:	0.00944	0.00941	1.00e-05	Validation Checks:	0	6	6
Epoch:	0	6 iterations	1000																																											
Time:		0:00:00																																												
Performance:	0.000128	1.07e-05	0.00																																											
Gradient:	0.00254	7.50e-05	1.00e-07																																											
Mu:	0.00100	1.00e-06	1.00e+10																																											
Validation Checks:	0	6	6																																											
Epoch:	0	6 iterations	1000																																											
Time:		0:00:00																																												
Performance:	0.00467	0.00467	0.00																																											
Gradient:	0.00944	0.00941	1.00e-05																																											
Validation Checks:	0	6	6																																											





Renee Miriam and Nivetha Martin

12	<p>Algorithms</p> <p>Data Division: Random (dividerand)          Training: Levenberg-Marquardt (trainlm)          Performance: Mean Squared Error (mse)          Calculations: MATLAB</p> <p>Progress</p> <table border="1"> <tr><td>Epoch:</td><td>0</td><td>6 iterations</td><td>1000</td></tr> <tr><td>Time:</td><td>0.000215</td><td>6.50e-06</td><td>0.00</td></tr> <tr><td>Performance:</td><td>0.00111</td><td>0.000156</td><td>1.00e-07</td></tr> <tr><td>Gradient:</td><td>0.00100</td><td>1.00e-06</td><td>1.00e+10</td></tr> <tr><td>Mu:</td><td>0.00100</td><td>1.00e-06</td><td>1.00e+10</td></tr> <tr><td>Validation Checks:</td><td>0</td><td>6</td><td>6</td></tr> </table>	Epoch:	0	6 iterations	1000	Time:	0.000215	6.50e-06	0.00	Performance:	0.00111	0.000156	1.00e-07	Gradient:	0.00100	1.00e-06	1.00e+10	Mu:	0.00100	1.00e-06	1.00e+10	Validation Checks:	0	6	6	<p>Algorithms</p> <p>Data Division: Random (dividerand)          Training: Gradient Descent with Adaptive Learning Rate (traingda)          Performance: Mean Squared Error (mse)          Calculations: MEX</p> <p>Progress</p> <table border="1"> <tr><td>Epoch:</td><td>0</td><td>6 iterations</td><td>1000</td></tr> <tr><td>Time:</td><td>0.00252</td><td>0.00252</td><td>0.00</td></tr> <tr><td>Performance:</td><td>0.00648</td><td>0.00635</td><td>1.00e-05</td></tr> <tr><td>Gradient:</td><td>0.00648</td><td>0.00635</td><td>1.00e-05</td></tr> <tr><td>Validation Checks:</td><td>0</td><td>6</td><td>6</td></tr> </table>	Epoch:	0	6 iterations	1000	Time:	0.00252	0.00252	0.00	Performance:	0.00648	0.00635	1.00e-05	Gradient:	0.00648	0.00635	1.00e-05	Validation Checks:	0	6	6
Epoch:	0	6 iterations	1000																																											
Time:	0.000215	6.50e-06	0.00																																											
Performance:	0.00111	0.000156	1.00e-07																																											
Gradient:	0.00100	1.00e-06	1.00e+10																																											
Mu:	0.00100	1.00e-06	1.00e+10																																											
Validation Checks:	0	6	6																																											
Epoch:	0	6 iterations	1000																																											
Time:	0.00252	0.00252	0.00																																											
Performance:	0.00648	0.00635	1.00e-05																																											
Gradient:	0.00648	0.00635	1.00e-05																																											
Validation Checks:	0	6	6																																											

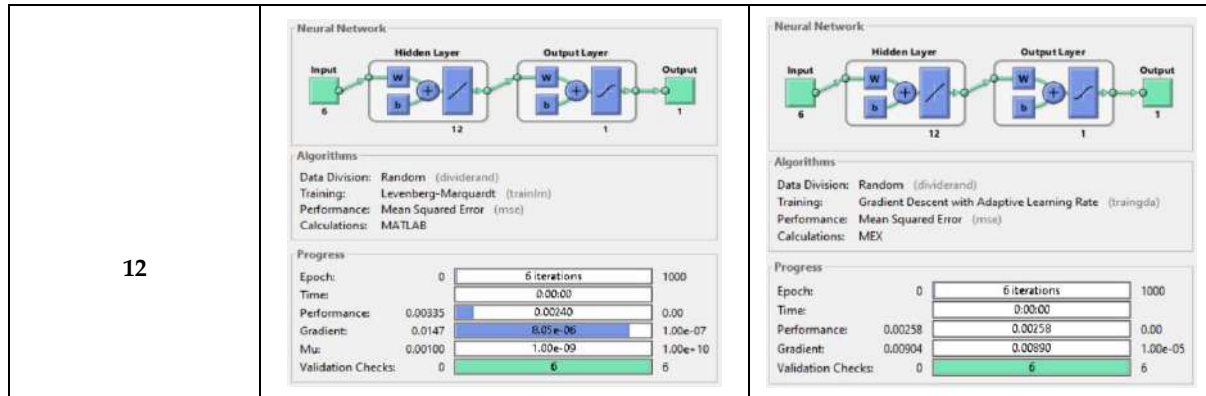
Table 3: Graphical Results of LEARNGDM, PURELIN, TRAINLM & TRAINGDA

Number of Neurons	LEARNGD & PURELIN																																													
	TRAINLM	TRAINGDA																																												
6	<p>Algorithms</p> <p>Data Division: Random (dividerand)          Training: Levenberg-Marquardt (trainlm)          Performance: Mean Squared Error (mse)          Calculations: MATLAB</p> <p>Progress</p> <table border="1"> <tr><td>Epoch:</td><td>0</td><td>6 iterations</td><td>1000</td></tr> <tr><td>Time:</td><td>0.00447</td><td>0.00759</td><td>0.00</td></tr> <tr><td>Performance:</td><td>0.0204</td><td>6.79e-09</td><td>1.00e-07</td></tr> <tr><td>Gradient:</td><td>0.00100</td><td>1.00e-09</td><td>1.00e+10</td></tr> <tr><td>Mu:</td><td>0.00100</td><td>1.00e-09</td><td>1.00e+10</td></tr> <tr><td>Validation Checks:</td><td>0</td><td>6</td><td>6</td></tr> </table>	Epoch:	0	6 iterations	1000	Time:	0.00447	0.00759	0.00	Performance:	0.0204	6.79e-09	1.00e-07	Gradient:	0.00100	1.00e-09	1.00e+10	Mu:	0.00100	1.00e-09	1.00e+10	Validation Checks:	0	6	6	<p>Algorithms</p> <p>Data Division: Random (dividerand)          Training: Gradient Descent with Adaptive Learning Rate (traingda)          Performance: Mean Squared Error (mse)          Calculations: MEX</p> <p>Progress</p> <table border="1"> <tr><td>Epoch:</td><td>0</td><td>6 iterations</td><td>1000</td></tr> <tr><td>Time:</td><td>0.00436</td><td>0.00435</td><td>0.00</td></tr> <tr><td>Performance:</td><td>0.0136</td><td>0.0132</td><td>1.00e-05</td></tr> <tr><td>Gradient:</td><td>0.0136</td><td>0.0132</td><td>1.00e-05</td></tr> <tr><td>Validation Checks:</td><td>0</td><td>6</td><td>6</td></tr> </table>	Epoch:	0	6 iterations	1000	Time:	0.00436	0.00435	0.00	Performance:	0.0136	0.0132	1.00e-05	Gradient:	0.0136	0.0132	1.00e-05	Validation Checks:	0	6	6
Epoch:	0	6 iterations	1000																																											
Time:	0.00447	0.00759	0.00																																											
Performance:	0.0204	6.79e-09	1.00e-07																																											
Gradient:	0.00100	1.00e-09	1.00e+10																																											
Mu:	0.00100	1.00e-09	1.00e+10																																											
Validation Checks:	0	6	6																																											
Epoch:	0	6 iterations	1000																																											
Time:	0.00436	0.00435	0.00																																											
Performance:	0.0136	0.0132	1.00e-05																																											
Gradient:	0.0136	0.0132	1.00e-05																																											
Validation Checks:	0	6	6																																											
8	<p>Algorithms</p> <p>Data Division: Random (dividerand)          Training: Levenberg-Marquardt (trainlm)          Performance: Mean Squared Error (mse)          Calculations: MATLAB</p> <p>Progress</p> <table border="1"> <tr><td>Epoch:</td><td>0</td><td>6 iterations</td><td>1000</td></tr> <tr><td>Time:</td><td>0.00286</td><td>0.00122</td><td>0.00</td></tr> <tr><td>Performance:</td><td>0.0252</td><td>1.59e-06</td><td>1.00e-07</td></tr> <tr><td>Gradient:</td><td>0.00100</td><td>1.00e-09</td><td>1.00e+10</td></tr> <tr><td>Mu:</td><td>0.00100</td><td>1.00e-09</td><td>1.00e+10</td></tr> <tr><td>Validation Checks:</td><td>0</td><td>6</td><td>6</td></tr> </table>	Epoch:	0	6 iterations	1000	Time:	0.00286	0.00122	0.00	Performance:	0.0252	1.59e-06	1.00e-07	Gradient:	0.00100	1.00e-09	1.00e+10	Mu:	0.00100	1.00e-09	1.00e+10	Validation Checks:	0	6	6	<p>Algorithms</p> <p>Data Division: Random (dividerand)          Training: Gradient Descent with Adaptive Learning Rate (traingda)          Performance: Mean Squared Error (mse)          Calculations: MEX</p> <p>Progress</p> <table border="1"> <tr><td>Epoch:</td><td>0</td><td>42 iterations</td><td>1000</td></tr> <tr><td>Time:</td><td>0.00499</td><td>0.00401</td><td>0.00</td></tr> <tr><td>Performance:</td><td>0.0137</td><td>0.0103</td><td>1.00e-05</td></tr> <tr><td>Gradient:</td><td>0.0137</td><td>0.0103</td><td>1.00e-05</td></tr> <tr><td>Validation Checks:</td><td>0</td><td>6</td><td>6</td></tr> </table>	Epoch:	0	42 iterations	1000	Time:	0.00499	0.00401	0.00	Performance:	0.0137	0.0103	1.00e-05	Gradient:	0.0137	0.0103	1.00e-05	Validation Checks:	0	6	6
Epoch:	0	6 iterations	1000																																											
Time:	0.00286	0.00122	0.00																																											
Performance:	0.0252	1.59e-06	1.00e-07																																											
Gradient:	0.00100	1.00e-09	1.00e+10																																											
Mu:	0.00100	1.00e-09	1.00e+10																																											
Validation Checks:	0	6	6																																											
Epoch:	0	42 iterations	1000																																											
Time:	0.00499	0.00401	0.00																																											
Performance:	0.0137	0.0103	1.00e-05																																											
Gradient:	0.0137	0.0103	1.00e-05																																											
Validation Checks:	0	6	6																																											
10	<p>Algorithms</p> <p>Data Division: Random (dividerand)          Training: Levenberg-Marquardt (trainlm)          Performance: Mean Squared Error (mse)          Calculations: MATLAB</p> <p>Progress</p> <table border="1"> <tr><td>Epoch:</td><td>0</td><td>6 iterations</td><td>1000</td></tr> <tr><td>Time:</td><td>0.00484</td><td>0.00410</td><td>0.00</td></tr> <tr><td>Performance:</td><td>0.0173</td><td>0.000115</td><td>1.00e-07</td></tr> <tr><td>Gradient:</td><td>0.00100</td><td>1.00e-09</td><td>1.00e+10</td></tr> <tr><td>Mu:</td><td>0.00100</td><td>1.00e-09</td><td>1.00e+10</td></tr> <tr><td>Validation Checks:</td><td>0</td><td>6</td><td>6</td></tr> </table>	Epoch:	0	6 iterations	1000	Time:	0.00484	0.00410	0.00	Performance:	0.0173	0.000115	1.00e-07	Gradient:	0.00100	1.00e-09	1.00e+10	Mu:	0.00100	1.00e-09	1.00e+10	Validation Checks:	0	6	6	<p>Algorithms</p> <p>Data Division: Random (dividerand)          Training: Gradient Descent with Adaptive Learning Rate (traingda)          Performance: Mean Squared Error (mse)          Calculations: MEX</p> <p>Progress</p> <table border="1"> <tr><td>Epoch:</td><td>0</td><td>6 iterations</td><td>1000</td></tr> <tr><td>Time:</td><td>0.00443</td><td>0.00441</td><td>0.00</td></tr> <tr><td>Performance:</td><td>0.0182</td><td>0.0176</td><td>1.00e-05</td></tr> <tr><td>Gradient:</td><td>0.0182</td><td>0.0176</td><td>1.00e-05</td></tr> <tr><td>Validation Checks:</td><td>0</td><td>6</td><td>6</td></tr> </table>	Epoch:	0	6 iterations	1000	Time:	0.00443	0.00441	0.00	Performance:	0.0182	0.0176	1.00e-05	Gradient:	0.0182	0.0176	1.00e-05	Validation Checks:	0	6	6
Epoch:	0	6 iterations	1000																																											
Time:	0.00484	0.00410	0.00																																											
Performance:	0.0173	0.000115	1.00e-07																																											
Gradient:	0.00100	1.00e-09	1.00e+10																																											
Mu:	0.00100	1.00e-09	1.00e+10																																											
Validation Checks:	0	6	6																																											
Epoch:	0	6 iterations	1000																																											
Time:	0.00443	0.00441	0.00																																											
Performance:	0.0182	0.0176	1.00e-05																																											
Gradient:	0.0182	0.0176	1.00e-05																																											
Validation Checks:	0	6	6																																											





**Renee Miriam and Nivetha Martin**



**Table 4: Table representing the output obtained by using TANSIG transfer function**

	TRAINLM				TRAINGDA			
	LEARNGDM& TANSIG							
Neurons	6	8	10	12	6	8	10	12
R <sup>2</sup>	0.99836	0.99838	0.98436	0.99048	0.94729	0.85727	0.78591	0.89113
MSE	0.00002	0.00000	0.00005	0.00013	0.00510	0.0268	0.02224	0.02056

**Table 5: Table representing the output obtained by using PURELIN transfer function**

	TRAINLM				TRAINGDA			
	LEARNGD& PURELIN							
Neurons	6	8	10	12	6	8	10	12
R <sup>2</sup>	0.84044	0.83437	0.83585	0.85012	0.82194	0.76193	0.80425	0.81010
MSE	0.04984	0.04897	0.05023	0.06106	0.02024	0.00143	0.02150	0.03734

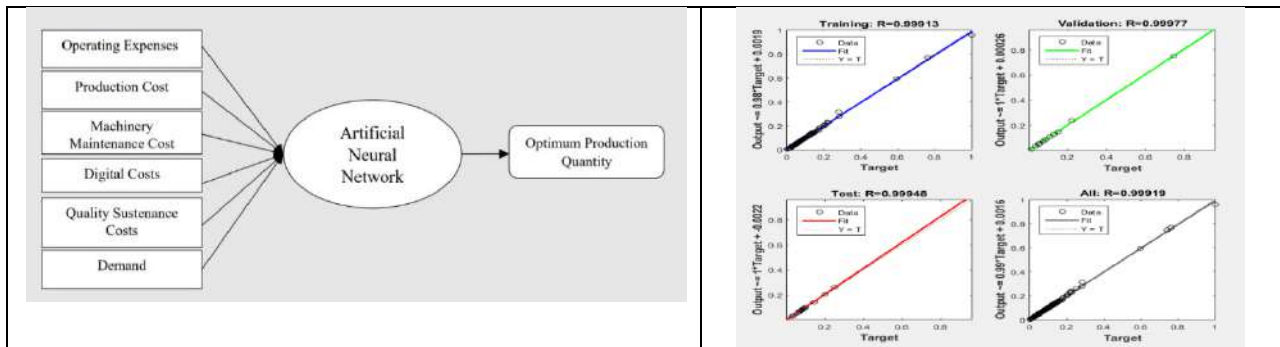
**Table 6: Summary of Optimal Neural Network**

<b>INPUT DATA</b>	Operation Expenses, Production Cost, Machinery Maintenance Cost, Digital Costs, Quality Sustenance Costs, Demand
<b>OUTPUT DATA</b>	Production Order Quantity
<b>NETWORK TYPE</b>	FEED FORWARD BACK PROPOGATION
<b>NUMBER OF HIDDEN LAYERS</b>	1
<b>TRAINING FUNCTION</b>	TRAINLM
<b>ADAPTION LEARNING FUNCTION</b>	LEARNGDM
<b>PERFORMANCE FUNCTION</b>	MSE
<b>TRANFER FUNCTION</b>	TANSIG



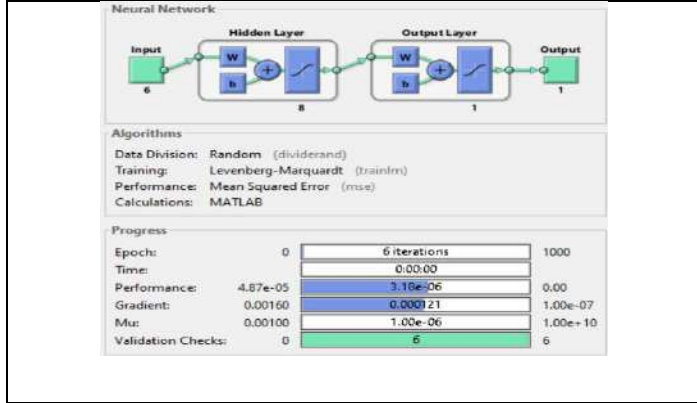


**Renee Miriam and Nivetha Martin**

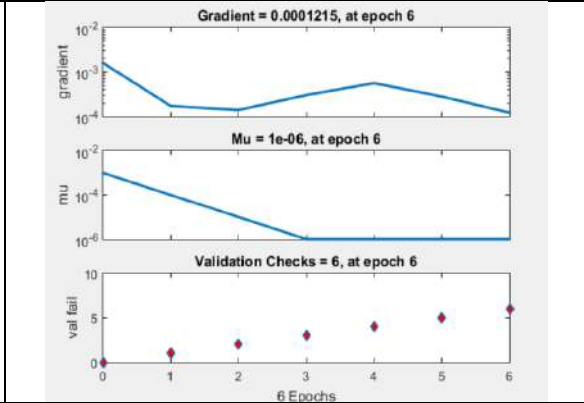


**Figure 1: Input & output parameters of ANN**

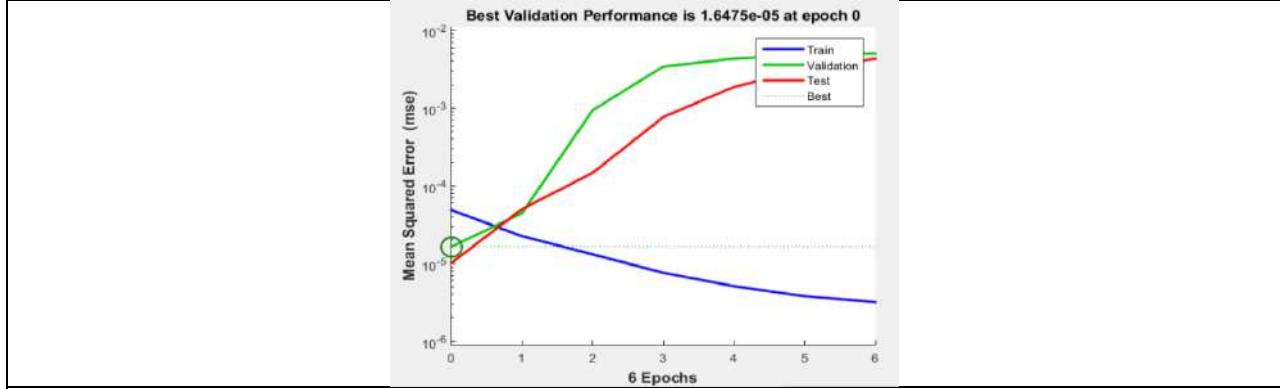
**Figure 2: Regression**



**Figure 3: Neural Network Architecture**



**Figure 4: Training State**



**Figure 5: Learning Performance**





# An Enhanced VM Migration Approach for Enhancing Hybrid Scheduling in Cloud Computing

B. Suganya<sup>1\*</sup> and R. Padmapriya<sup>2</sup>

<sup>1</sup>Research Scholar, Department of Computer Science, RVS College of Arts and Science, Sullur, (Affiliated to Bharathiar University, Coimbatore) Coimbatore, Tamil Nadu, India.

<sup>2</sup>Associate Professor and HoD, Department of BCA, School of Computer Studies, RVS College of Arts and Science, Sullur, (Affiliated to Bharathiar University, Coimbatore) Coimbatore, Tamil Nadu, India.

Received: 22 Jan 2024

Revised: 09 Feb 2024

Accepted: 09 May 2024

## \*Address for Correspondence

### B. Suganya

Research Scholar,  
Department of Computer Science,  
RVS College of Arts and Science,  
Sullur, (Affiliated to Bharathiar University, Coimbatore)  
Coimbatore, Tamil Nadu, India.  
Email: suganyaaphd20@gmail.com



This is an Open Access Journal / article distributed under the terms of the **Creative Commons Attribution License** (CC BY-NC-ND 3.0) which permits unrestricted use, distribution, and reproduction in any medium, provided the original work is properly cited. All rights reserved.

## ABSTRACT

Cloud computing is a promising solution for high-performance systems, but it can be challenging to meet multiple objectives such as makespan, resource use, etc. To address this, we developed a Task Scheduling (TS) algorithm based on Multi-objective Grey Wolf Optimization (TSMGWO) to efficiently allocate jobs to resources. While the TSMGWO algorithm enhanced resource usage and minimized makespan, it resulted in an imbalance in job distribution among nodes, leading to some Physical Machines (PMs) having excessive or insufficient workloads, which increased energy consumption. Also, MGWO has slower convergence and poor global searchability for the constraints in cloud computing. Therefore, this article proposes a novel approach that combines both TS and Load Balancing (LB) algorithms in heterogeneous cloud networks based on the Dove Optimization Algorithm (DOA) instead of the GWO algorithm. The DOA achieves rapid convergence and effective global searchability to optimize both TS and LB in cloud computing based on the multiple objectives. DOA is used to determine the best jobs and Virtual Machines (VMs) for migration to suitable PMs. The best jobs are selected based on the fitness function of all VMs, and the best VMs for migration are chosen based on the fitness function of all PMs. This approach efficiently achieves TS-LB by mapping jobs to VMs. Extensive simulations reveal that the TSLBDOA outperforms other TS-LB algorithms in cloud computing.

**Keywords:** Cloud networks, Job scheduling, Load balancing, Dove optimizer, VM migration







## INTRODUCTION

Cloud computing has grown significantly in recent years, providing flexible on-demand services like infrastructure, platforms, and software over the internet. However, the reliance on shared cloud resources can lead to uneven distribution, with some VMs unable to access needed resources [1]. Effective TS is crucial to optimize resource utilization and system stability [2]. Traditional schemes like First-Come-First-Serve (FCFS) and Maximum-Minimum (Max-Min) can get stuck in local minima [3]. Recently, many metaheuristics have been developed for TS and LB in cloud networks. The Adaptive Pbest Discrete Particle Swarm Optimization (APDPSO) is a cloud-based technique for LB [4] that updates the best particle locations by incorporating improved external archive data. However, it only addresses static LB problems and increases computing complexity with more particles or iterations. The LB with Particle Swarm Genetic Optimization and Resource Allocation (LBPSGORA) method [5] uses PSO and Genetic Algorithm (GA) to schedule jobs and evenly distribute workload among hosts, but it does not consider LB dependability and reaction times. The Clustering-based Multiple Objective Dynamic LB (CMODLB) approach [6] achieves load balance between cloud platform VM and PM loads using clustering and optimization techniques, but it lacks energy efficiency and does not consider storage-intensive operations.

Hung et al. [7] integrate genetic methods to improve VM performance models, but this approach consumes more computing resources, leading to a degradation in LB performance. A parallel SARSA reinforcement learning and GA [8] were developed for cloud platform, but scheduling takes longer as it employs a single agent for simplification purposes. An Adaptive Neuro-Fuzzy Interference System-Polynomial Neural Network (ANFIS-PNN) along with memory-based GWO [9] enhances LB, but new objective functions are needed to enhance LB service availability and performance. The GWO algorithm [10] balances load by considering resource dependability, but additional parameters and dependability are required to adaptively balance dependent job load. An enhanced genetic Ant Colony Optimization (ACO) technique [11] offers adaptive data stream transfer but ignores LB with several hosts and controllers. Jena et al. [12] combine Modified PSO with enhanced Q-learning (QMPSO) to develop a dynamic Load LB for VMs, but it does not consider the dynamic LB for dependent tasks. Additionally, the TSMGWO [13] have shown promise for near-optimal TS by balancing multiple criteria. However, it does not consider energy consumption, specifically the PMs and other factors like memory and bandwidth usage. The usage of PMs can vary depending on the number of scheduled tasks, leading to either excessive or insufficient use. Therefore, this manuscript proposes a VM migration in conjunction with the TS based on the DOA in heterogeneous cloud networks. The primary objective of this study is to effectively balance energy utilization among PMs. The novel contribution of this algorithm lies in the utilization of the DOA for simultaneous TS and VM migration in cloud platforms. The DOA enables the selection of optimal tasks and VMs to migrate to the most suitable PMs concurrently. The VM migration is optimized by considering the fitness function of all PMs, which identifies the best mapping correlation between selected VMs and the most appropriate PM. As a result, this approach reduces energy consumption and evenly distributes the load among all PMs in the network.

## MATERIALS AND METHODS

### Problem Description

All PMs on the cloud network have varying amounts of VMs and tasks. The PMs and VMs are signified as  $PM = \{PM_1, PM_2, \dots, PM_p\}$ , and  $VM = \{VM_1, VM_2, \dots, VM_v\}$ , respectively, whereas the tasks are represented by  $S = \{S_1, S_2, \dots, S_s\}$ . Here,  $p$  and  $v$  represent the total number of PMs, and VMs, respectively,  $s$  denote the total number of tasks. The primary goal of this study is to decrease energy consumption, optimize resource utilization, and ensure an even distribution of workload across all PMs in a cloud network. The network's makespan and energy usage for the job can be enhanced through a balanced load distribution. To avoid this issue, a hybrid TS-LB algorithm is proposed, which includes the DOAs depicted in Figure 1.





**Suganya and Padmapriya**

**Dove Optimization Algorithm for Job Scheduling and VM Migration**

The DOA is developed based on the dove’s foraging behavior [14]. The objective function for TS is  $f(\underline{W}) = [f_1, f_2, f_3, f_4]$ , where  $f_1$  is the makespan,  $f_2$  is the ET (degree of imbalance),  $f_3$  is the memory utilization, and  $f_4$  is the bandwidth utilization. Every job  $\underline{j}$  in the job list is defined as a location with crumbs and the amount of crumbs in this location  $\underline{W}$  contains  $g(\underline{W})$  crumbs. The optimal result defines where it is the location with the most crumbs.

Step 1: Choose the amount of doves  $N$  and arrange them on the result area, i.e., uniformly distributed on the space.  
 Step 2: Assign the epoch number,  $e = 0$  and the degree of satiety,  $s_d^e$  for dove  $d, d = 1, \dots, N$ . The initialization of the location vector  $\underline{W}_d \in R^M$  of  $d$  is performed in 2 methods. The basic method is to arbitrarily set  $\underline{W}_d$  around the result area. Another method is lattice initialization scheme, which is described below.

Consider the minimum hyper-rectangle for the parameter area that has the effective values of each parameter, represented by  $[l_1, u_1], \dots, [l_M, u_M]$ , where  $l_a$  and  $u_a$  are the lower and upper margin of the  $a$ -dimension in the result area. The main concept of this scheme is to squeeze the  $n$ -dimensional hyper-rectangle into a 2D surface; thus a 2D system will efficiently enclose the result area. Utilize  $i$  and  $j$  to index the rectangular cells from 1 to  $A \times B$ .

**Initialization of the cells on the 4 corners: The weight vectors of the 4 neurons on the network corners are set by**

$$\begin{aligned} \underline{w}_{1,1} &= (l_1, l_2, \dots, l_M)^T \\ \underline{w}_{A,B} &= (u_1, u_2, \dots, u_M)^T \\ \underline{w}_{1,B} &= \left( l_1, l_2, \dots, l_{\lfloor \frac{M}{2} \rfloor}, u_{\lfloor \frac{M}{2} \rfloor + 1}, \dots, u_M \right)^T \\ \underline{w}_{A,1} &= \left( u_1, u_2, \dots, u_{\lfloor \frac{M}{2} \rfloor}, l_{\lfloor \frac{M}{2} \rfloor + 1}, \dots, l_M \right)^T \end{aligned} \tag{1}$$

**Initialization of the cells on the 4 boundaries: Initialize the cell’s value on the 4 boundaries based on**

$$\begin{aligned} \underline{w}_{1,j} &= \frac{\underline{w}_{1,B} - \underline{w}_{1,1}}{B-1} (j-1) + \underline{w}_{1,1} \\ &= \frac{j-1}{B-1} \underline{w}_{1,B} + \frac{B-j}{B-1} \underline{w}_{1,1}, j = 2, \dots, B-1 \\ \underline{w}_{A,j} &= \frac{\underline{w}_{A,B} - \underline{w}_{A,1}}{B-1} (j-1) + \underline{w}_{A,1} \\ &= \frac{j-1}{B-1} \underline{w}_{A,B} + \frac{B-j}{B-1} \underline{w}_{A,1}, j = 2, \dots, B-1 \\ \underline{w}_{i,1} &= \frac{\underline{w}_{A,1} - \underline{w}_{1,1}}{A-1} (i-1) + \underline{w}_{1,1} \\ &= \frac{i-1}{A-1} \underline{w}_{A,1} + \frac{A-i}{A-1} \underline{w}_{1,1}, i = 2, \dots, A-1 \\ \underline{w}_{i,B} &= \frac{\underline{w}_{A,B} - \underline{w}_{1,B}}{A-1} (i-1) + \underline{w}_{1,B} \\ &= \frac{i-1}{A-1} \underline{w}_{A,B} + \frac{A-i}{A-1} \underline{w}_{1,B}, i = 2, \dots, A-1 \end{aligned} \tag{2}$$

$$\begin{aligned} \underline{w}_{i,j} &= \frac{\underline{w}_{A,j} - \underline{w}_{1,j}}{A-1} (i-1) + \underline{w}_{1,j} = \frac{i-1}{A-1} \underline{w}_{A,j} + \frac{A-i}{A-1} \underline{w}_{1,j} \\ &= \frac{i-1}{A-1} \left( \frac{j-1}{B-1} \underline{w}_{A,B} + \frac{B-j}{B-1} \underline{w}_{A,1} \right) + \frac{A-i}{A-1} \left( \frac{j-1}{B-1} \underline{w}_{1,B} + \frac{B-j}{B-1} \underline{w}_{1,1} \right) \\ &= \frac{(j-1)(i-1)\underline{w}_{A,B} + (j-1)(A-1)\underline{w}_{1,B} + (B-j)(i-1)\underline{w}_{A,1} + (B-j)(A-i)\underline{w}_{1,1}}{(B-1)(A-1)} \end{aligned} \tag{3}$$

**Initialization of the residual cells: The weight vectors of the 4 neurons on the network corners are assigned. The residual neurons are initialized from top to bottom and from left to right.**

Step 3: Determine the each dove’s fitness function  $f(\underline{w}_j^e), j = 1, \dots, N$  at epoch as a cumulative amount of the crumbs in the location of the  $d^{th}$  dove.

Step 4: Place  $d_j^e$  closest to the maximum crumbs by the extreme condition at  $e$ :

$$d_j^e = \operatorname{argmax}\{f(\underline{w}_j^e)\}, j = 1, \dots, N \tag{4}$$





**Suganya and Padmapriya**

Step 5: Modify all doves' satiety degree by

$$S_j^e = \lambda S_j^{e-1} + e^{(f(w_j) - f(w_{d_f}))}, j = 1, \dots, N \tag{5}$$

Step 6: Choose the highly gratified ( $d_s^e$ ), with the maximum  $s_d^e$  by below principle:

$$d_s^e = \operatorname{argmax}_{1 \leq j \leq N} \{S_j^e\}, j = 1, \dots, N \tag{6}$$

The dove  $d_s$  chosen by Eq. (6) is  $d$  that achieves the optimal foraging efficiency and it is the one that earns to be limited by other doves in the flock.

Step 7: Modify all doves' location vector by

$$w_j^{e+1} = w_j^e + \eta \beta_j^e (w_{d_s}^e - w_j^e) \tag{7}$$

$$\text{Where } \beta_j^e = \left( \frac{S_{d_s}^e - S_j^e}{S_{d_s}^e} \right) \left( 1 - \frac{\|w_j^e - w_{d_s}^e\|}{\text{maxDist}} \right) \tag{8}$$

$$\text{maxDist: } \max_{1 \leq j \leq N} \|w_j - w_j\| \tag{9}$$

In Eq. (7),  $\eta$  indicates the training rate to modify  $d$ 's location vector.

Step 8: Return to Step 3 and increase the epoch number by 1, i.e.  $e = e + 1$  until the termination criterion is achieved.

The termination criterion is defined by

$$|f_{d_s}^e - T(e)| \leq \text{maximum epoch} \tag{10}$$

When the optimization is the minimum condition, i.e. the ideal result is to obtain the least  $f(w_j^e)$ , then Eqns. (4) & (5) can be updated as follows:

$$d_j^e = \operatorname{argmin}\{f(w_j^e)\}, j = 1, \dots, N \tag{11}$$

$$S_j^e = \begin{cases} \lambda S_j^{e-1} + e^{(f(w_j) - f(w_{d_f}))}, & f(w_{d_f}) \neq 0, j = 1, \dots, N \\ \lambda S_j^{e-1} + 1, & f(w_{d_f}) = 0 \end{cases} \tag{12}$$

Additionally, each dove determines the standard variance ( $\sigma$ ) for every PM for identifying PMs having insufficient and excessive workloads (i.e., assigned jobs). The objective is to determine the workload of all PMs by considering the load of VMs deployed on them. The average load of  $k^{th}$  VM in  $l^{th}$  PM ( $\overline{AL}_{VM_{lk}}$ ) is calculated as:

$$\overline{AL}_{VM_{lk}} = CPU_k + M_k + B_k \tag{13}$$

In Eq. (13),  $CPU_k, M_k$  and  $B_k$  are the use of CPU, memory, and bandwidth of  $k^{th}$  VM, respectively. The average load of  $l^{th}$  PM ( $\overline{AL}_{PM_l}$ ) and standard variance for  $l^{th}$  PM ( $\sigma_l$ ) is calculated as:

$$\overline{AL}_{PM_l} = \frac{\sum_{k=1}^m \overline{AL}_{VM_{lk}}}{m}, \forall VM_1, \dots, VM_v \in PM_l \tag{14}$$

$$\sigma_l = \sqrt{\frac{1}{p} \sum_{l=1}^p (\overline{AL}_{PM} - \overline{AL}_{PM_l})^2} \tag{15}$$

In Eq. (15),  $p$  represents the number of PMs and  $\overline{AL}_{PM}$  represents the average load of all PMs, calculated as:

$$\overline{AL}_{PM} = \frac{1}{p} \sum_{l=1}^p \overline{AL}_{PM_l} \tag{16}$$

When  $\sigma_l$  falls below the minimum threshold,  $PM_l$  may become an underutilized host. On the other hand, when  $\sigma_l$  exceeds the maximum threshold,  $PM_l$  may become an overloaded host. The threshold value is determined as follows: the minimum threshold is the lowest  $\overline{AL}_{PM_l}$  among all PMs, while the maximum threshold is the equal to  $\overline{AL}_{PM_l}$ . Once the underutilized or overloaded PMs are identified, the dove initiates its swings in the knowledge base to inform all doves about the solutions. During this process, the knowledge base applies the DOA to distribute hosts according to Eq. (17) and takes into account the energy utilization of all PMs. Subsequently, the updated list of hosts is utilized to identify the suitable PM for migrating VM from it. The DOA calculates the fitness value ( $F_l$ ) according to the overloaded or underutilized PMs as:

$$F_l = \frac{(\tau_l)^\alpha * (\eta_l)^\beta}{\sum_{l=1}^p (\tau_l)^\alpha * (\eta_l)^\beta} \tag{17}$$

$$F_l = \frac{\left(\frac{1}{\tau_l}\right)^\alpha * (\eta_l)^\beta}{\sum_{l=1}^p \left(\frac{1}{\tau_l}\right)^\alpha * (\eta_l)^\beta} \tag{18}$$





**Suganya and Padmapriya**

In Eqns. (17) & (18),  $\alpha$  and  $\beta$  represent the virtual reputation among doves  $\tau_l$ , and the weight  $\eta_l$ , respectively. The dove parameter  $\tau_l$  is determined by the load of  $PM_l$ . So, the most suitable  $PM_l$  is obtained and utilized in the migration state to notify each dove through the knowledge base. Afterwards, the dove picks the appropriate VM to migrate to the other PM using the minimum migration interval strategy. This strategy is determined by

$$\frac{RAM(a)}{B_{ex_l}} \leq \frac{RAM(u)}{B_{ex_l}}, \forall a, u \in VM_k \tag{19}$$

In Eq. (19),  $VM_k$  represents the set of VMs presently distributed to  $PM_l$  and  $B_{ex_l}$  denotes the extra bandwidth available for  $PM_l$ . The parameters  $RAM(a)$  and  $RAM(u)$  indicate the amount of RAM presently utilized by  $VM_a$  and  $VM_u$ , respectively. The DOA then identifies the best mapping correlation between the selected VMs and the most suitable PM by evaluating a fitness value. This mapping must align with the knowledge base of available PMs.

$$Fitness(VM_k, PM_l) = \frac{CPU_{PM_l} - CPU_{VM_k}}{CPU_{VM_k}} \cdot \frac{M_{PM_l} - M_{VM_k}}{M_{VM_k}} \cdot \frac{B_{ex_{PM_l}} - B_{ex_{VM_k}}}{B_{ex_{VM_k}}} \cdot \frac{S_{PM_l} - S_{VM_k}}{S_{VM_k}} \tag{20}$$

In Eq. (20),  $CPU_{VM_k}$ ,  $M_{VM_k}$ ,  $B_{ex_{VM_k}}$  and  $S_{VM_k}$  denote the factors required by the VM (i.e., the use of CPU, memory, bandwidth, and storage volume, respectively), while  $CPU_{PM_l}$ ,  $M_{PM_l}$ ,  $B_{ex_{PM_l}}$  and  $S_{PM_l}$  denote the factors contained by the PM (i.e., the use of CPU, memory, bandwidth, and storage volume, respectively). Finally, the dove takes into account the data regarding VMs that can be migrated and selects the suitable PM to migrate the VM based on the knowledge base. The dove carries out the migration process by transferring the VM to the appropriate PM. Algorithm 1 outlines the process of TS and VM migration using DOA to achieve a balanced load distribution in a cloud network.

**Algorithm 1: DOA-based TS-LB**

Input: Dove population (D), maximum iteration ( $i_{max}$ ), the number of reliable jobs ( $\{[RT]_x\}$ ,  $x \in \{1, \dots, X\}$ ), number of VMs ( $\{[VM]_v\}$ ), number of PMs ( $\{[PM]_p\}$ ), and number of tasks ( $S_s$ )

Output: Set of optimal job schedules, best VMs to migrate to the most suitable PMs

```

Begin
  Initialize early dove locations,  $s_d^e$ ;
  while( $i < i_{max}$ )
    Place the dove closest to the largest amount of crumbs;
    Modify all doves' satiety degree values;
    Choose the most satisfied dove with the maximum degree of satiety;
    Modify all doves' location vector;
  end while
  Find the best dove  $s_{best}$  in the search space, and the optimal fitness value ( $f(s_{best})$ );
  Obtain the optimal set of reliable job schedules;
  for(all VMs and PMs)
    Calculate the standard variance  $\sigma_l$  using Eq. (15);
    Identify underutilized and overloaded PMs;
    Calculate the fitness value of overloaded and underutilized PMs using Eqns. (17) and (18), respectively;
    Calculate the fitness value of each VM using Eq. (20);
  end for
  Find the most optimal VMs and PMs for VM migration;
End
    
```

**SIMULATION RESULTS**

This section shows the effectiveness of the TSLBDOA by implementing it in the CloudSim API 3.0.3 tool. To compare its performance with existing algorithms like TSMGWO [13], APDPSO [4], SARSA-GA [8], and ANFIS-PNN-GWO [9], all the algorithms are executed in a cloud environment constructed with the parameters outlined in Table 1.

**Makespan**

The total time required for a user to complete a task, from submission to completion, is referred to as the makespan. Figure 2 illustrates the makespan results for the proposed and existing TS-LB algorithms. On average, the



**Suganya and Padmapriya**

TSLBDOA exhibits a noteworthy decrease in makespan compared to the APDPSO, ANFIS-PNN-GWO, SARSA-GA, and TSMGWO, with reductions of 37.79%, 30.4%, 26.82%, and 20.55% respectively.

**Degree-of-Imbalance (DoI)**

It is commonly referred to as the execution time, which quantifies the imbalance in workload distribution among VMs based on their capabilities. In Figure 3, the DoI results of the proposed and existing TS-LB algorithms are compared. On average, the TSLBDOA reduces DoI by 56.64%, 52.43%, 48.42%, and 41.67% compared to the APDPSO, ANFIS-PNN-GWO, SARSA-GA, and TSMGWO algorithms, respectively.

**Memory Utilization**

It determines the maximum memory requirement for each VM during job execution. Figure 4 illustrates the memory utilization of various TS-LB algorithms in cloud networks. On average, the TSLBDOA reduces memory utilization by 39.49%, 33.11%, 29.29%, and 26.67% compared to the APDPSO, ANFIS-PNN-GWO, SARSA-GA, and TSMGWO, respectively.

**Bandwidth Utilization**

It determines the maximum bandwidth requirement for job execution of each VM. Figure 5 illustrates the bandwidth utilization of various TS-LB algorithms in cloud platforms. On average, the TSLBDOA demonstrates a reduction in bandwidth usage by 22.21%, 17.9%, 16.27%, and 13.97% when compared to the APDPSO, ANFIS-PNN-GWO, SARSA-GA, and TSMGWO, respectively.

**Energy Utilization**

This refers to the total energy consumption by PMs during a specific time frame. Figure 6 illustrates a comparison of energy utilization among different TS-LB algorithms in cloud platforms. The TSLBDOA stands out for its significant reduction in energy usage, resulting in savings of 59.03%, 51.73%, 42.31%, and 35.22% compared to the APDPSO, ANFIS-PNN-GWO, SARSA-GA, and TSMGWO algorithms, respectively. This impressive accomplishment can be attributed to the effective LB and TS techniques employed, particularly the utilization of DOA. The DOA facilitates load balancing by migrating optimal VMs to the most suitable PM, ultimately leading to a decrease in overall energy consumption.

**Number of VM Migration**

This is the count of migrations generated during the VM migration phase. Figure 7 illustrates a comparison of the number of VM migrations for different TS-LB algorithms against a varied number of tasks. On average, the TSLBDOA demonstrates the lowest number of VM migrations compared to the other algorithms. Specifically, the TSLBDOA outperforms the APDPSO, ANFIS-PNN-GWO, SARSA-GA, and TSMGWO by about 72.73%, 67.57%, 59.32%, and 46.67%, respectively. This can be attributed to the effectiveness of DOA in scheduling optimal tasks for VMs and selecting the most suitable VM to migrate to the most appropriate PM, thereby achieving load balancing.

**CONCLUSION**

This paper presents the development of a hybrid TSLBDOA that aims to achieve a balanced load distribution in cloud networking by concurrently executing TS and VM migration. The objective is to optimize energy efficiency and load distribution in cloud networks by selecting the most appropriate PMs from the entire network. The DOA is used to identify the most suitable VMs for migration to the best available PMs. The proposed algorithm's performance is evaluated through simulation using various metrics and workloads. The simulation results demonstrate that the TSLBDOA outperforms earlier TS-LB algorithms in terms of makespan, DoI, memory consumption, bandwidth use, energy usage, and the number of VM migrations.





## Suganya and Padmapriya

## REFERENCES

1. H. Talebian, A. Gani, M. Sookhak, A.A. Abdelatif, A.Yousafzai, A.V.Vasilakos, and F.R. Yu, "Optimizing Virtual Machine Placement in IaaS Data Centers: Taxonomy, Review and Open Issues," *Cluster Computing*, vol. 23, pp. 837-878, Jun. 2020.
2. E.H. Houssein, A.G. Gad, Y.M.Wazery, and P.N. Suganthan, "Task Scheduling in Cloud Computing Based on Meta-Heuristics: Review, Taxonomy, Open Challenges, and Future Trends," *Swarm and Evolutionary Computation*, vol. 62, p. 100841, Apr. 2021.
3. R. Ghafari, F.H. Kabutarkhani, and N.Mansouri, "Task Scheduling Algorithms for Energy Optimization in Cloud Environment: A Comprehensive Review," *Cluster Computing*, vol. 25, no. 2, pp. 1035-1093, Apr. 2022.
4. Z. Miao, P. Yong, Y. Mei, Y. Qunjun, and X. Xu, "A Discrete PSO-Based Static Load Balancing Algorithm for Distributed Simulations in a Cloud Environment," *Future Generation Computer Systems*, vol. 115, pp. 497-516, 2021.
5. S.M. Mirmohseni, A.Javadpour, and C. Tang, "LBPSGORA: Create Load Balancing with Particle Swarm Genetic Optimization Algorithm to Improve Resource Allocation and Energy Consumption in Clouds Networks," *Mathematical Problems in Engineering*, vol. 2021, pp. 1-15, Jun. 2021.
6. S. Negi, M.M.S. Rauthan, K.S. Vaisla, and N.Panwar, "CMODLB: An Efficient Load Balancing Approach in Cloud Computing Environment," *The Journal of Supercomputing*, vol. 77, pp. 8787-8839, Aug. 2021.
7. L.H. Hung, C.H. Wu, C.H. Tsai, and H.C. Huang, "Migration-Based Load Balance of Virtual Machine Servers in Cloud Computing by Load Prediction Using Genetic-Based Methods," *IEEE Access*, vol. 9, pp. 49760-49773, Mar. 2021.
8. Asghari, M.K. Sohrabi, and F.Yaghmaee, "Task Scheduling, Resource Provisioning, and Load Balancing on Scientific Workflows Using Parallel SARSA Reinforcement Learning Agents and Genetic Algorithm," *The Journal of Supercomputing*, vol. 77, pp. 2800-2828, Mar. 2021.
9. U. Chourasia and S.Silakari, "Adaptive Neuro Fuzzy Interference and PNN Memory Based Grey Wolf Optimization Algorithm for Optimal Load Balancing," *Wireless Personal Communications*, vol. 119, pp. 3293-3318, Aug. 2021.
10. S. Sefati, M. Mousavinasab, and R.ZarehFarkhady, "Load Balancing in Cloud Computing Environment Using the Grey Wolf Optimization Algorithm Based on the Reliability: Performance Evaluation," *The Journal of Supercomputing*, vol. 78, no. 1, pp. 18-42, Jan. 2022.
11. J. He, "Cloud Computing Load Balancing Mechanism Taking into Account Load Balancing Ant Colony Optimization Algorithm," *Computational Intelligence and Neuroscience*, vol. 2022, pp. 1-10, Apr. 2022.
12. U.K. Jena, P.K. Das, and M.R.Kabat, "Hybridization of Meta-Heuristic Algorithm for Load Balancing in Cloud Computing Environment," *Journal of King Saud University-Computer and Information Sciences*, vol. 34, no. 6, pp. 2332-2342, Jun. 2022.
13. D. Alsadie, "TSMGWO: Optimizing Task Schedule Using Multi-Objectives Grey Wolf Optimizer for Cloud Data Centers," *IEEE Access*, vol. 9, pp. 37707-37725, Mar. 2021.
14. M.C. Su, J.H. Chen, A.M. Utami, S.C. Lin, and H.H. Wei, "Dove Swarm Optimization Algorithm," *IEEE Access*, vol. 10, pp. 46690-46696, Apr. 2022.

Table 1. Simulation Environment and Parameters

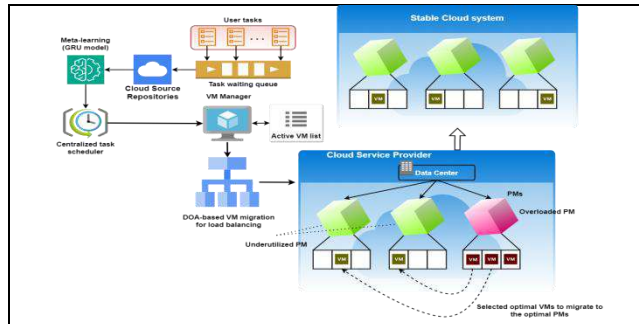
Type	Parameter	Range
Host	No. of hosts	100
	No. of processing elements per host	4
	Bandwidth	3Gbps
	Host memory	8GB
	MIPS of PE	2060
VM	No. of VMs	450
Cloudlets	No. of tasks (jobs)	1000



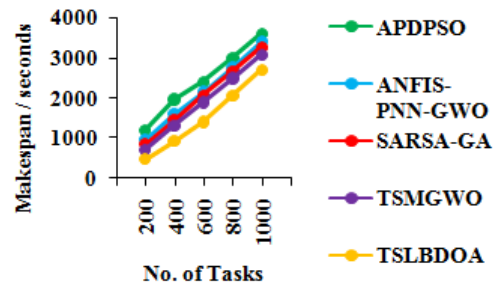


**Suganya and Padmapriya**

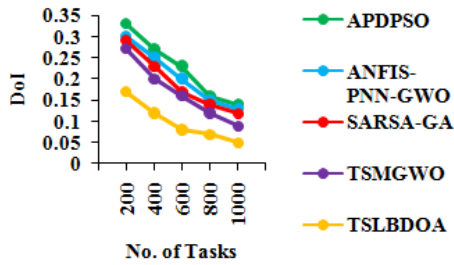
	Task length (Million Instructions (MI))	2500*simulation limit
	No. of PEs per demand	2
<b>DOA</b>	Number of population	120
	$\lambda$	0.9
	$\eta$	0.18~0.375



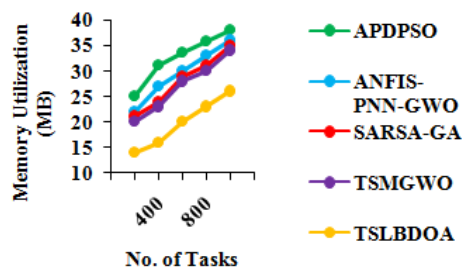
**Figure 1. Overview of Proposed Hybrid TS-LB Algorithm**



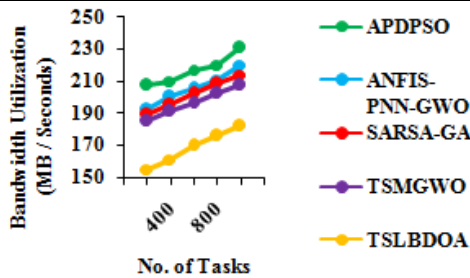
**Figure 2. Makespan vs. No. of Tasks**



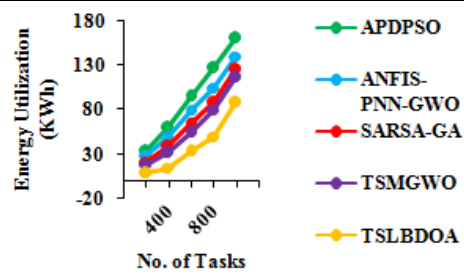
**Figure 3. DoI vs. No. of Tasks**



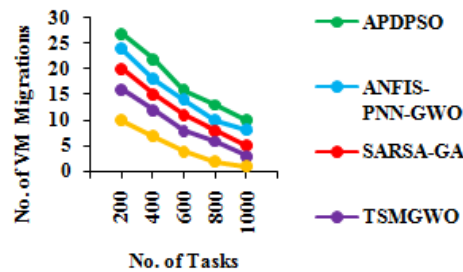
**Figure 4. Memory Use vs. No. of Tasks**



**Figure 5. Bandwidth Use vs. No. of Tasks**



**Figure 6. Energy Use vs. No. of Tasks**



**Figure 7. VM Migrations vs. Tasks**





## RESEARCH ARTICLE

## A New Technique for using Symmetric Pentagonal Intuitionistic Fuzzy Numbers to Solve Assignment Problem

G.Sudha\*

Assistant Professor, Department of Mathematics, A.D.M.College for Women (Autonomous), Nagapattinam, (Affiliated to Bharathidasan University, Tiruchirappalli), Tamil Nadu, India.

Received: 22 Jan 2024

Revised: 09 Feb 2024

Accepted: 27 Apr 2024

### \*Address for Correspondence

**G.Sudha**

Assistant Professor,  
Department of Mathematics,  
A.D.M.College for Women (Autonomous),  
Nagapattinam, (Affiliated to Bharathidasan University, Tiruchirappalli),  
Tamil Nadu, India.  
Email: sudha1994ganesan@gmail.com



This is an Open Access Journal / article distributed under the terms of the **Creative Commons Attribution License** (CC BY-NC-ND 3.0) which permits unrestricted use, distribution, and reproduction in any medium, provided the original work is properly cited. All rights reserved.

### ABSTRACT

Assignment Problem is a particular case of the Transportation problem in which the objective is to assign a number of tasks to an equal number of facilities at a minimum cost (or maximum profit). In this paper, we deal with solving a Symmetric Pentagonal Intuitionistic Fuzzy Assignment Problem (SPIFAP). The Hungarian method is used for solving SPIFAP by using ranking function for fuzzy costs. A numerical example is considered by incorporating a SPIFAP.

**Keywords:** Intuitionistic fuzzy number, Pentagonal fuzzy number, Symmetric pentagonal fuzzy number, fuzzy assignment problem, ranking function.

## INTRODUCTION

A specific case of Transportation Problem (TP) with equal number of resources and activities is known as Assignment Problem (AP). It is effectively used in solving realistic problems for finding the best alternative solutions. AP plays an essential role in managerial decision making. It is related to the problem of production planning, scheduling and engineering design problem. AP was introduced in Vo Taw and Orden (1952). All the algorithms which are used to find the optimal solution of TP are suitable to the AP. But Kuhn [6] introduced a specific algorithm to find the optimal solution for AP which is degenerate in nature named as Hungarian algorithm. In real world situations, the boundary of AP is not a fixed real number because the tasks by various persons or machines take the different time and cost due to different reasons. P.K. De, Bharti Yadav [3] discussed







**Sudha**

a general approach for solving AP involving with fuzzy cost coefficients. Kadhirvel. K and Balamurugan. K [5] discussed method for solving Hungarian AP using triangular and trapezoidal fuzzy number. In reality , different procedures and algorithms namely,linear programming method,neural network method, genetic algorithm and Hungarian algorithm were used to solve the AP. In traditional AP, It is assumed that all the parameters related to AP are fixed valued. In this paper, a fuzzy AP is considered. The cost values of the fuzzy AP are taken as SPIFAP. The SPIFAP are converted into crisp values using Ranking function. The problem is then solved by the usual Hungarian method. This paper is organized as follows: In section 1, Introduction is presented. In section 2, brief notions about symmetric pentagonal Intuitionistic fuzzy numbers are described. Mathematical formulation of AP is given in section 3. Solution methodology is given in section 4. In section 5, a numerical example is given for illustration purpose. Section 6 concludes the paper with further scope of research.

**PRELIMINARIES**

**Intuitionistic Fuzzy Set (IFS)**

Intuitionistic fuzzy set  $\tilde{G}^1$  in  $Q$  is given by a set of ordered triples:

$$\tilde{G}^1 = \{ \langle q, \mu_{\tilde{G}^1}(q), \nu_{\tilde{G}^1}(q) \rangle \mid q \in Q \}$$

where  $\mu_{\tilde{G}^1}, \nu_{\tilde{G}^1} : Q \rightarrow [0,1]$  are function such that  $0 \leq \mu_{\tilde{G}^1} + \nu_{\tilde{G}^1} \leq 1$  for all  $q \in Q$ . For each  $q$  in the number  $\mu_{\tilde{G}^1}$  and  $\nu_{\tilde{G}^1}$  represent the degree of membership and non-membership of the element  $q \in Q$  to  $G \subset Q$  respectively.

**Intuitionistic Fuzzy Number (IFN) – Atanassov (1986)**

An Intuitionistic fuzzy number  $\mu_{\tilde{G}^1}$  is

- i. An Intuitionistic fuzzy subset of the real line.
- ii. Normal. ie., there is any  $q_1 \in R$  such that  $\mu_{\tilde{G}^1}(q_1) = 1$ , so that  $\nu_{\tilde{G}^1}(q_1) = 0$ .
- iii. Convex for the membership function  $\mu_{\tilde{G}^1}(Q)$ .

$$\mu_{\tilde{G}^1}(q) (\tau q_1 + (1 - \tau)q_2) \geq \text{Min}(\mu_{\tilde{G}^1}(q_1), \mu_{\tilde{G}^1}(q_2)), q_1, q_2 \in R, \tau \in [0,1]$$

- iv. Concave for the non-membership function  $\nu_{\tilde{G}^1}(Q)$

$$\nu_{\tilde{G}^1}(q) (\tau q_1 + (1 - \tau)q_2) \geq \text{Min}(\nu_{\tilde{G}^1}(q_1), \nu_{\tilde{G}^1}(q_2)), q_1, q_2 \in R, \tau \in [0,1]$$

**Pentagonal Intuitionistic Fuzzy Number (PIFN)**

Pentagonal Intuitionistic fuzzy numbers of an intuitionistic fuzzy set  $\tilde{G}_1$  denoted as

$\tilde{G}_{PIFN} = (r_1, r_2, r_3, r_4, r_5; r_1', r_2', r_3', r_4', r_5')$  and whose membership function and non - membership function is

$$\text{defined as } \mu_{GPIFN}(z) = \begin{cases} 0 & \text{for } z < r_1 \\ \left(\frac{z-r_1}{r_2-r_1}\right) & \text{for } r_1 \leq z \leq r_2 \\ \left(\frac{z-r_2}{r_3-r_2}\right) & \text{for } r_2 \leq z \leq r_3 \\ 1 & \text{for } z = r_3 \\ \left(\frac{r_4-z}{r_4-r_3}\right) & \text{for } r_3 \leq z \leq r_4 \\ \left(\frac{r_5-x}{r_5-r_4}\right) & \text{for } r_4 \leq z \leq r_5 \\ 0 & \text{for } z > r_5 \end{cases}$$





**Sudha**

$$\vartheta_{G_{PIFN}}(z) = \begin{cases} 1 & \text{for } z < r'_1 \\ \left(\frac{r'_2-z}{r'_2-r'_1}\right) & \text{for } r'_1 \leq z \leq r'_2 \\ \left(\frac{r'_3-z}{r'_1-r'_2}\right) & \text{for } r'_2 \leq z \leq r'_3 \\ 0 & \text{for } z = r'_3 \\ \left(\frac{z-r'_3}{r'_4-r'_3}\right) & \text{for } r'_3 \leq z \leq r'_4 \\ \left(\frac{z-r'_4}{r'_5-r'_4}\right) & \text{for } r'_4 \leq z \leq r'_5 \\ 1 & \text{for } z > r'_5 \end{cases}$$

**Symmetric Pentagonal Intuitionistic Fuzzy Number (SPIFN)**

Symmetric Pentagonal Intuitionistic fuzzy numbers of a intuitionistic fuzzy set  $\tilde{G}_{SPIFN} = (d, u, u, v, v; d, u', u', v', v')$  and whose membership function and non - membership function is defined as

$$\mu_{G_{PIFN}}(z) = \begin{cases} \frac{z - (d - v)}{v - u} & \text{for } d - v \leq z \leq d - u \\ \frac{z - (d - u)}{u} & \text{for } d - u \leq z \leq d \\ 1 & \text{for } z = d \\ \frac{(d + u) - z}{u} & \text{for } d \leq z \leq d + u \\ \frac{(d + v) - z}{v - u} & \text{for } d + u \leq z \leq d + v \\ 0, & \text{otherwise} \end{cases}$$

$$\vartheta_{G_{SPIFN}}(z) = \begin{cases} \frac{(d-u')-z}{v'-u'} & \text{for } d - v' \leq z \leq d - u' \\ \frac{d-z}{u'} & \text{for } d - u' \leq z \leq d \\ 0 & \text{for } z = d \\ \frac{z-d}{u'} & \text{for } d \leq z \leq d + u' \\ \frac{z-(d+u')}{v'-u'} & \text{for } d + u' \leq z \leq d + v' \\ 1, & \text{otherwise} \end{cases}$$

**Ranking of SPIFN**

If  $\tilde{G}_{SPIFN} = (d, u, u, v, v; d, u', u', v', v')$  is a SPIFN then the Ranking is defined by

$$\Re(\tilde{G}_{SPIFN}) = \int_0^1 4(0.5)(w_\sigma^g, w_\sigma^h) d\sigma, \text{ where } (w_\sigma^g, w_\sigma^h) = 2\sigma[u + u'] + 4[2d] + 2\sigma[v + v']$$

**Mathematical Formulation of Fuzzy Assignment Problem**

The following table provides the (n x n) cost matrix [K<sub>ij</sub>] of actual values that can be used to represent the assignment problem:





**Sudha**

Districts Salesmen	Dti <sub>1</sub>	Dti <sub>2</sub>	Dti <sub>3</sub>	Dtij...	Dti <sub>n</sub>
S <sub>1i</sub>	K <sub>11</sub>	K <sub>12</sub>	K <sub>13</sub>	..K <sub>1j</sub> ...	K <sub>1n</sub>
S <sub>2i</sub>	K <sub>21</sub>	K <sub>22</sub>	K <sub>23</sub>	..K <sub>2j</sub> ...	K <sub>2n</sub>
S <sub>3i</sub>	K <sub>31</sub>	K <sub>32</sub>	K <sub>33</sub>	..K <sub>3j</sub> ...	K <sub>3n</sub>
.....	....	.....	....	.....	.....
S <sub>lij</sub>	K <sub>i1</sub>	K <sub>i2</sub>	K <sub>i3</sub>	..K <sub>ij</sub> ...	K <sub>in</sub>
.....	....	.....	....	.....	.....
S <sub>in</sub>	K <sub>n1</sub>	K <sub>n2</sub>	K <sub>n3</sub>	..K <sub>nj</sub> ...	K <sub>nn</sub>

The intention is to minimize the total expenditure, thus let  $K_{ij}$  be the fuzzy cost of allocating the  $i^{th}$  districts to the  $j^{th}$  salesperson and  $z_{ij}$  be the decision variable indicating the assignment of the  $i^{th}$  districts to the  $j$  salesperson. The fuzzy assignment problem is represented mathematically by.

$$\text{Minimize } z = \sum_{i=1}^n \sum_{j=1}^n K_{ij} z_{ij}$$

$$\text{Subject to } \sum_{i=1}^n z_{ij} = 1, j=1, 2, 3, \dots, n$$

$$\sum_{j=1}^n z_{ij} = 1, i=1, 2, 3, \dots, n$$

Where  $z_{ij} = \begin{cases} 1, & \text{if the } i^{th} \text{ districts is assigned to the } j^{th} \text{ salesmen} \\ 0, & \text{Otherwise} \end{cases}$

**Assignment Algorithm (Hungarian Method)**

**Step 1:** Examine whether the problem is balanced or unbalanced.

- a) If both districts and salesmen have an equal number, the problem is considered balanced.
- b) If not, it will be unbalanced.

**Step 2:** Choose the lowest cost element in both rows and columns and mark it.

**Step 3:** Continue in this manner until all of the rows and columns have been examined, considering into account the subsequent row as well as the subsequent column and marking the minimum cost element. Take into consideration the salesperson or district with the lowest cost if there are different allotments in any row or column.

**Step 4:** Check each and every row or column have allotment.

**Illustrative Example**

Suppose a fuzzy assigning in which four districts are depicted by rows, and four salesman with assignment costs are represented by columns. The following table illustrates the cost matrix  $(K_{ij})_{n \times n}$ , whose elements are SPIFN..





**Sudha**

Districts Salesmen	$Dt_1$	$Dt_2$	$Dt_3$	$Dt_4$
$Sl_1$	$\langle\langle(6,2,2,3,3);(6,4,4,5,5)\rangle\rangle$	$\langle\langle(2,4,4,8,8);(2,1,1,5,5)\rangle\rangle$	$\langle\langle(3,2,2,7,7);(3,5,5,4,4)\rangle\rangle$	$\langle\langle(7,3,3,9,9);(7,6,6,8,8)\rangle\rangle$
$Sl_2$	$\langle\langle(5,7,7,9,9);(5,8,8,7,7)\rangle\rangle$	$\langle\langle(8,3,3,5,5);(8,4,4,6,6)\rangle\rangle$	$\langle\langle(6,5,5,4,4);(6,3,3,9,9)\rangle\rangle$	$\langle\langle(7,5,5,8,8);(7,9,9,3,3)\rangle\rangle$
$Sl_3$	$\langle\langle(9,4,4,7,7);(9,5,5,6,6)\rangle\rangle$	$\langle\langle(6,8,8,10,10);(6,12,12,7,7)\rangle\rangle$	$\langle\langle(5,6,6,7,7);(5,4,4,2,2)\rangle\rangle$	$\langle\langle(9,4,4,7,7);(9,5,5,4,4)\rangle\rangle$
$Sl_4$	$\langle\langle(7,9,9,15,15);(7,10,10,12,12)\rangle\rangle$	$\langle\langle(6,10,10,13,13);(6,7,7,11,11)\rangle\rangle$	$\langle\langle(7,5,5,9,9);(7,6,6,8,8)\rangle\rangle$	$\langle\langle(8,3,3,6,6);(8,7,7,4,4)\rangle\rangle$

**Solution:**

It is evident that this SPIFN is balanced. We've acquired  $\mathfrak{R}(\tilde{K}_{ij})$  of each  $\tilde{K}_{ij}$ , Using the Ranking methodology that was described in (2.5), we get

$$\mathfrak{R}(\tilde{K}_{11}) = \int_0^1 4(0.5)(w_\sigma^g, w_\sigma^h) d\sigma = \int_0^1 4(0.5)[2\sigma(6) + 4(12) + 2\sigma(8)] d\sigma = 124$$

The following table 1, 2, 3 & 4 shows the assessment for the fuzzy  $\tilde{K}^{th}$  matrix.

The Optimal solution is  $Sl_1 \rightarrow Dt_2, Sl_2 \rightarrow Dt_1, Sl_3 \rightarrow Dt_3, Sl_4 \rightarrow Dt_4$

The Optimum assignment cost = 68 + 102 + 118 + 168 = Rs.456.

**CONCLUSION**

This study examines the cost and time of the SPIF assignment and establishes a solution mechanism for it. Additionally, the SPIFAP has been transformed into a crisp assignment problem by the use of a ranking function, and an assignment algorithm is used to determine the best answer.

**REFERENCES**

1. K. T. Atanassov, "Intuitionistic fuzzy sets," *Fuzzy Sets and Systems*, vol. 20, no. 1, pp. 87-96, 1986.
2. R.E Bellman & L.A. Zadeh, "Decision Making under in a fuzzy environment", *Management Science*, vol. 17, pp: 141-164, 1970.
3. M.S, Chen, "On a Fuzzy Assignment Problem", *Tamkang Journal of Mathematics*, vol. 22, pp.407- 411, 1985.
4. K. De, Bharti Yadev, "A General approach for solving Assignment problems involving with fuzzy cost coefficients", *Modern Applied Science*, vol. 6, no.3, pp.2-10, 2012.
5. D. Dubois, and H. Prade, "Fuzzy sets and system: Theory and Applications", Academic Press, New York, 1980.
6. M.S. Huang & W.O. Rom, "Solving the assignment problem by relaxation", *Operations Research*, vol. 28, no.4, pp.969-982, 1980.
7. K. Kadhivel, K Balamurugan, "Method for solving Hungarian Assignment Problem using Triangular and Trapezoidal fuzzy number", *International Journal of Engineering Research and Applications*, vol. 2, no.5, pp.399-403, 2012.





**Sudha**

8. H.W. Kuhn, "The Hungarian method for assignment problem", *Naval Research Logistics Quarterly*, vol. 2, pp.83-97, 1955.
9. J.C. Lin. And P.U. Wen, "The labeling algorithm for the assignment and transportation problem", *Naval Research Logistics Quarterly*, vol. 2, pp.83-97, 2004.
10. Mohamed Muamer, "Fuzzy Assignment Problem", *Journal of Science*, vol.10, pp.40-47, 2020.
11. G. Santhi, M. Ananthanarayanan, "Solving fuzzy Assignment Problem using Minimum Algorithm", *Advances and Applications in Mathematical Sciences*, vol.21, no.12, pp. 6819-6826, 2022.
12. X. Wang, "Fuzzy Assignment Problem, *Fuzzy Math.3*, pp.101- 108, 1987.
13. L.A. Zadeh, "Fuzzy Sets", *Information and Control*, vol. 8, no.3, pp.338- 352, 1965.

**Table -1: Ranking of SPIF assignment cost**

Districts Salesmen	Dt <sub>1</sub>	Dt <sub>2</sub>	Dt <sub>3</sub>	Dt <sub>4</sub>
Sl <sub>1</sub>	124	68	84	164
Sl <sub>2</sub>	102	164	170	162
Sl <sub>3</sub>	188	170	118	184
Sl <sub>4</sub>	148	158	112	168

**Table -2: Subtracts the row minimum**

Districts Salesmen	Dt <sub>1</sub>	Dt <sub>2</sub>	Dt <sub>3</sub>	Dt <sub>4</sub>
Sl <sub>1</sub>	56	0	16	96
Sl <sub>2</sub>	0	62	68	60
Sl <sub>3</sub>	70	52	0	66
Sl <sub>4</sub>	36	46	0	56

**Table 3: Subtracts the column minimum**

Districts Salesmen	Dt <sub>1</sub>	Dt <sub>2</sub>	Dt <sub>3</sub>	Dt <sub>4</sub>
Sl <sub>1</sub>	56	0	16	40
Sl <sub>2</sub>	0	62	68	4
Sl <sub>3</sub>	70	52	0	10
Sl <sub>4</sub>	36	46	0	0

**Table -4: The Optimal Solution**

Districts Salesmen	Dt <sub>1</sub>	Dt <sub>2</sub>	Dt <sub>3</sub>	Dt <sub>4</sub>
Sl <sub>1</sub>	56	(0)	16	40
Sl <sub>2</sub>	(0)	62	68	4
Sl <sub>3</sub>	70	52	(0)	10
Sl <sub>4</sub>	36	46	0	(0)





## India's Dental Tourism Landscape: A Comprehensive Analysis of Growth, Quality, and Global Competitiveness

Suzana Hasan Ali Alqafeai<sup>1</sup>, Sakhi John<sup>2\*</sup> and Shibu John<sup>3</sup>

<sup>1</sup>Ph.D Scholar, Department of Healthcare and Pharmaceutical Management, School of Management and Business Studies, Jamia Hamdard (Deemed to be University) New Delhi, India.

<sup>2</sup>Assistant Professor, Department of Healthcare and Pharmaceutical Management, School of Management and Business Studies, Jamia Hamdard (Deemed to be University) New Delhi, India.

<sup>3</sup>Professor, Department of Hospital Management, Jamia Millia Islamia University, New Delhi, 110025

Received: 22 Jan 2024

Revised: 09 Feb 2024

Accepted: 06 May 2024

### \*Address for Correspondence

**Sakhi John**

Assistant Professor,

Department of School of Management and Business Studies,

Jamia Hamdard School of Management,

Jamia Hamdard University,

New Delhi, India.

Email: [sjohn@jamiyahamdard.ac.in](mailto:sjohn@jamiyahamdard.ac.in)



This is an Open Access Journal / article distributed under the terms of the **Creative Commons Attribution License** (CC BY-NC-ND 3.0) which permits unrestricted use, distribution, and reproduction in any medium, provided the original work is properly cited. All rights reserved.

### ABSTRACT

The concept of dental tourism has grown out of the need for cost-effective medical procedures, which are often unaffordable in patients' home countries. With the rise in healthcare costs globally, patients are increasingly seeking alternatives, paving the way for countries like India to enter the medical tourism market. Studies have highlighted the competitive advantages of medical tourism destinations, with a focus on economic, social, and regulatory factors. The literature suggests that India's integration into the dental tourism market is bolstered by its lower costs, skilled workforce, and modern medical facilities. This study employs a mixed-methods approach, combining quantitative data on medical tourism trends with qualitative interviews from stakeholders in the Indian dental tourism sector. The aim is to assess the current status and potential growth of this niche market within the broader medical tourism industry. The findings indicate that India's dental tourism sector is experiencing growth due to its cost advantages, quality of dental care, and favourable policies. However, challenges such as international accreditation, marketing, and perception management need to be addressed to sustain growth. The implications of this study are significant for policymakers and healthcare providers. By understanding the factors driving the success of dental tourism in India, strategies can be formulated to enhance the sector's competitive edge, thereby contributing to the country's economic development and global healthcare standing.





Suzana Hasan Ali Alqafeai *et al.*,

**Keywords:** Dental tourism, Medical tourism, Growth factors, Cosmetic dental treatments

## INTRODUCTION

Medical tourism has rapidly evolved into a global phenomenon, characterized by patients' willingness to cross international borders in the pursuit of medical treatment that is either unavailable or prohibitively expensive in their home countries. India has emerged as a premier destination in this sector, not only due to its cost-effective treatments but also because of its high-quality services, skilled professionals, and cutting-edge technology (Agrawal & Gupta, 2020). This paper explores the burgeoning scope of medical tourism in India, with a particular focus on dental care services – a niche that has seen a significant surge in demand due to the intersection of quality, accessibility, and affordability. The allure of India's dental tourism lies in its ability to offer a unique amalgamation of top-tier dental care with the enriching experience of Indian culture and hospitality (Gupta, 2008; Turner, 2007). The aim of this study is to review the current scenario of medical tourism in India, scrutinizing the factors that contribute to its appeal, the challenges it faces, and the opportunities that lie ahead, especially in the realm of dental care. By examining a variety of sources, including statistical data, patient testimonials, and policy frameworks, we offer a comprehensive overview of the industry's present state and its potential trajectory. The paper is structured to first provide a background on the global context of medical tourism, followed by an in-depth analysis of India's positioning in the market. Subsequent sections delve into the specifics of dental care services as a potent driver of medical tourism in India, discussing the implications for healthcare providers, policymakers, and patients alike. Our research methodology involves both qualitative and quantitative analyses, drawing on a rich tapestry of literature and firsthand accounts to paint a picture of a dynamic industry at the cusp of transformation. Through this study, we aspire to contribute to the discourse on medical tourism and offer insights that can help shape its future development in India and beyond.

### Importance of India in Medical Tourism

India has gained a reputation as a global medical tourism hub due to its competitive advantages in cost, quality, and the range of services offered (Mitra & Chawla, 2016). According to studies by the Confederation of Indian Industry (CII) and the Indian Ministry of Tourism, the cost of surgery in India is one-tenth of what it is in the United States or Western Europe (Confederation of Indian Industry, 2021).<sup>(26)</sup> Moreover (Garg & Bhardwaj, 2012; Hazarika, 2010), Indian hospitals adhere to international standards, with over 38 JCI-accredited hospitals by 2020 (Singh & Saxena, 2020). The proficiency and expertise of Indian medical professionals are well-documented (Smith & Forgione, 2007). Many Indian doctors have been trained or have worked in the best medical institutions worldwide, bringing a wealth of knowledge and experience to their practice (Gupta, 2008). The negligible language barrier due to widespread English fluency further adds to the ease with which international patients can navigate the Indian medical system (Turner, 2007). India's traditional healthcare practices, such as Ayurveda, have also garnered international interest, with tourists seeking holistic wellness treatments alongside conventional medical procedures (John & Chelat, 2013; Kalshetti & Pillai, 2008). Government policies have augmented this interest, with visa-on-arrival schemes for tourists from certain countries seeking medical treatment, which was introduced as part of the 'Incredible India' campaign (Kalshetti & Pillai, 2008). The convergence of these factors has not only made India a top destination for medical tourism but has also contributed significantly to the country's economy. The medical tourism industry in India is projected to reach \$9 billion by 2022 (Binoy & Monisha, 2011), indicating the sector's robust growth and its critical role in India's economic landscape (Connell, 2006).





Suzana Hasan Ali Alqafeai *et al.*,

### Dental Tourism

Dental tourism, a subset of medical tourism, has become one of the fastest-growing segments within the industry, with India positioning itself as a desirable destination for dental care. Within the broader spectrum of medical tourism, dental tourism has surfaced as a fast-growing sector. The exorbitant cost of dental care in developed countries, coupled with long waiting periods, has compelled patients to seek dental services abroad (Dhama *et al.*, 2016). Dental tourism, a subset of medical tourism, is where individuals seek dental care outside their local healthcare systems, often coupled with a vacation (Bookman, 2007). India's dental tourism is marked by its advanced clinics, experienced dentists, and the added allure of combining dental treatments with the exploration of India's diverse cultural landscape (Wong *et al.*, 2014). The impetus behind the dental tourism boom in India is multifaceted: it includes substantial cost savings for patients, immediate treatment options without the burden of wait-lists, and the appeal of combining dental care with leisure travel. The Indian government has recognized this potential, crafting policies to enhance infrastructure, streamline visa processes for medical tourists, and promote the country as a global healthcare destination (Kalshetti & Pillai, 2008; Turner, 2011). The convergence of these dynamics has positioned India not just as a viable alternative to Western medical care but as a preferred destination, carving out a niche in the global market and contributing to the country's economic growth (Connell, 2013). This paper delves into the interplay between the burgeoning phenomenon of medical tourism and India's rise as a dental tourism hub, exploring the implications for healthcare delivery, economic development, and the global healthcare market.

### COMPREHENSIVE SURVEY OF EXISTING LITERATURE

The emergence of medical tourism as a significant sector within the global health economy has been well-documented (Holliday *et al.*, 2019). Researchers have explored its multifaceted nature, examining the economic, socio-cultural, and health-related aspects of this global phenomenon (Bookman, 2007). Medical tourism encompasses a variety of services, with dental care emerging as one of the most significant due to its accessibility and cost differential across borders (Dhama *et al.*, 2016).

### The Global Context of Medical Tourism

Medical tourism is not a new concept, but its scale and scope have expanded dramatically in the 21st century (Connell, 2006). (Gahlinger, 2008) posits that the integration of healthcare and tourism industries has resulted in a unique economic model that benefits both developed and developing nations. However, as (Connell, 2006) note, the quality of healthcare, including patient safety and post-treatment care, remains a critical area of concern and study.

### India's Position in the Medical Tourism Industry

Medical tourism, defined as people traveling internationally to access medical treatment, has seen significant global growth, with India emerging as a key destination. This growth is attributed to advancements in technology, cost differentials, and improved healthcare standards, as noted by (Smith & Forgione, 2007). India's appeal in this sector stems from factors such as the use of English, skilled medical professionals, and advanced technology in healthcare, as described by (Gupta, 2008) (Horowitz *et al.*, 2007). Government support has been pivotal, with policies aimed at easing visa restrictions for medical tourists and promoting healthcare quality, as highlighted by (Bookman, 2007) (Dawn & Pal, 2011). The economic impact of medical tourism in India is significant, contributing substantially to the country's healthcare revenue and indirectly supporting allied sectors, according to (Reddy & Qadeer, 2010; Turner, 2007). Patient satisfaction levels are generally high, attributed to quality care and efficient service; however, (Cohen, 2010) raises concerns over ethical issues, including potential prioritization of international patients. Challenges in the sector include managing ethical implications and maintaining international standards, with (Johnston *et al.*, 2010) suggesting the need for careful consideration of these aspects. The future of medical tourism in India appears promising, with potential growth in areas like wellness tourism, as explored by (Telej & Gamble, 2019).





**Suzana Hasan Ali Alqafeai et al.,****Dental Tourism as a Growth Area**

Dental tourism, a segment of the broader medical tourism market, involves individuals traveling for dental treatments, motivated by factors such as cost savings and the opportunity to combine dental care with leisure travel. This trend is particularly pronounced due to the high cost of dental care in developed countries and the availability of high-quality, lower-cost services in developing nations, as (Akbar et al., 2020; Carrera & Bridges, 2006) outline. The rise in dental tourism is linked to the larger trend in health-related travel, with countries like Hungary, Mexico, and Thailand becoming popular due to their combination of affordability and high standards, as (Turner, 2011) notes. Developing countries, notably in Asia and Eastern Europe, have seen a surge in this sector, with India, Thailand, and Hungary offering advanced dental procedures at reduced costs, and investing in state-of-the-art facilities to attract international patients (Bookman, 2007) (Bookman & Bookman, 2007; (Gopalan et al., 2014). The economic and social implications of dental tourism are significant, contributing to the host countries' economies and creating employment opportunities in healthcare and related sectors like hospitality (Smith & Forgione, 2007). However, this growth also raises concerns about resource allocation and the potential neglect of local healthcare needs (Cohen, 2010). Patient experiences in dental tourism are generally positive, with satisfaction in the quality of care received, modern facilities, skilled dentists, and personalized service being highlighted. Yet, there are ethical considerations, including the quality of post-treatment care and legal recourse in malpractice cases (Heung et al., 2011). The sustainability of dental tourism faces challenges such as ensuring consistent quality of care and managing impacts on local healthcare systems. Future research directions could explore the long-term implications of dental tourism on global healthcare dynamics and the ethical considerations in this growing industry (Johnston et al., 2010).

**Cost Differences**

A focused literature review reveals significant cost differences in dental services between India and developed countries, greatly influencing international patients' decisions. Studies, such as those by (Dang et al., 2020; Zarei et al., 2020), underscore India's cost-effectiveness, with dental procedures costing substantially less – up to 70-80% lower than in Western countries, as reported by (Yildiz & Khan, 2016). This notable price disparity is attributed to lower labour and operational costs in India, as discussed by (Muslim, 2016) and is further supported by favourable government policies highlighted by (Mason, 2023). Comparative analysis by (Ebrahim & Ganguli, 2019) also positions India as competitively priced even when compared to other medical tourism hotspots like Thailand and Malaysia. The impact of these cost differences on patient choice, as explored by (Zakaria et al., 2023) emphasizes the significant role that economic considerations play in the burgeoning field of dental tourism in India. This review collectively suggests that cost is a pivotal factor driving the choice of India as a preferred destination for dental care among international patients.

**Range Of Services**

Literature reveals a diverse range of services that significantly contribute to the sector's appeal. (Gahlinger, 2008; Kamath et al., 2015) have documented the wide array of dental treatments available in India, ranging from basic care to advanced cosmetic and surgical procedures, including implants, veneers, crowns, bridges, and orthodontics. These services are enhanced by the use of cutting-edge technology like digital imaging and laser dentistry, a key factor in attracting international patients as highlighted by (Achilov, 2021). Quality and accreditation also play a crucial role in the dental tourism industry in India. Many dental clinics and hospitals adhere to rigorous standards, with several being JCI (Joint Commission International) accredited, ensuring global benchmarking in service quality (Akbar et al., 2020). Additionally, Indian dental clinics are known for their customized treatment plans, tailored to the unique needs and preferences of international patients, thereby enhancing patient satisfaction and treatment outcomes (Agrawal & Gupta, 2020).



**Suzana Hasan Ali Alqafeai et al.,**

An emerging trend in the Indian dental tourism market, as observed by (Dang et al., 2020), is the integration of dental treatments with traditional Indian wellness therapies. This holistic approach not only addresses dental issues but also offers a comprehensive health experience, blending modern dental care with traditional wellness practices. This literature review underscores India's competitive edge in the dental tourism sector, showcasing its commitment to quality, technological advancement, and patient-centric care.

**Accessibility and Convenience**

The literature underscores the significant role of accessibility and convenience in bolstering India's position in the global dental tourism market. A key aspect is the country's transport and connectivity, as highlighted by (Ebrahim & Ganguli, 2019; Singh & Dhankhar, 2021). Major cities, which are the focal points of dental tourism, boast well-connected international airports and efficient internal transportation networks, making travel easy for international patients. Further enhancing accessibility are India's medical visa regulations and government policies. (Dang et al., 2020; Reddy & Qadeer, 2010) emphasize the streamlined visa processes and the provision for extended stays, which are particularly beneficial for patients undergoing extensive dental treatments. The healthcare infrastructure in India, equipped with modern dental clinics and technologies, further adds to the convenience for international patients seeking comprehensive care, as noted by (Dhama et al., 2016; Gupta, 2008). These facilities often extend services like online consultations and travel assistance, specifically tailored for international patients. Language and communication also play a crucial role. The widespread use of English in Indian healthcare facilities, as discussed by (Wong et al., 2014; Yildiz & Khan, 2016), significantly reduces language barriers, making India an attractive destination for a global clientele. Additionally, the availability of quality accommodations and hospitality services in close proximity to healthcare providers, as pointed out by (DeMicco, 2017), further contributes to the overall convenience and comfort for medical tourists in India. This literature review collectively suggests that the aspects of accessibility and convenience are integral to the appeal of India's dental tourism sector, offering a seamless and comfortable experience for international patients.

**Patient Satisfaction**

The literature highlights that patient satisfaction and outcomes are critical factors contributing to the sector's success. (Campbell et al., 2020; Heydari et al., 2019) they reported high levels of patient satisfaction, largely attributed to the quality of care, cost-effectiveness, and personalized services offered by Indian dental clinics. Patients particularly commend the professionalism and expertise of dental practitioners, reflecting positively on their overall experience. The quality of dental treatments in India, including clinical outcomes, also receives considerable attention in the literature. Studies by (Klein et al., 2017; Raggio et al., 2020) document the high success rates of various dental procedures, such as implants and cosmetic dentistry, which are facilitated by the use of advanced technology and quality materials, as noted by (Campbell et al., 2020). This contributes significantly to positive patient outcomes. Furthermore, comparisons between dental services in India and patients' home countries reveal a preference for Indian services. According to (Ebrahim & Ganguli, 2019; Wong et al., 2014), factors such as lower costs, shorter waiting times, and the added appeal of combining treatment with vacation significantly enhance patient satisfaction. The aspect of post-treatment care, including follow-up and communication with Indian dental clinics, also plays a vital role in long-term satisfaction, as discussed by (Adabi et al., 2017; Gaines & Lee, 2019). Effective follow-up care strategies are essential in maintaining high levels of patient satisfaction. This literature review collectively indicates that India's dental tourism sector excels in both patient satisfaction and treatment outcomes, underpinned by its commitment to quality care, advanced technology, and patient-centric services. The positive comparison with services in patients' home countries and the emphasis on effective post-treatment care further consolidate India's position as a favoured destination for dental tourism.





Suzana Hasan Ali Alqafeai et al.,

### Patient Satisfaction and Outcomes

A focused literature review reveals that international patients consistently report high levels of satisfaction with their dental care experiences. According to (Campbell et al., 2020; Heydari et al., 2019) they suggested, this satisfaction stems from the quality of care, affordability, and the personalized attention provided in Indian dental facilities. Testimonials frequently commend the expertise of Indian dental professionals and the utilization of advanced technology in treatments. When it comes to treatment outcomes, studies like those conducted by (Lunt et al., 2010; Lunt et al., 2016) have documented successful results, especially in complex dental procedures like cosmetic dentistry and implants. The success of these treatments is largely due to the adoption of cutting-edge technologies and adherence to international quality standards. Furthermore, comparative analyses with dental services in developed countries, as discussed by (Awadzi & Panda, 2006; Masoud et al., 2013), indicate that India not only offers comparable or superior quality treatments at significantly lower costs but also benefits from shorter waiting times for treatments. These factors collectively contribute to the high satisfaction levels and positive treatment outcomes reported by patients. An important aspect of patient satisfaction pertains to post-treatment experiences and follow-up care. Indian dental clinics, recognizing this, have been enhancing their post-treatment care and patient support, as highlighted by (Dhakate & Joshi, 2023). The focus on comprehensive patient care has been crucial in ensuring long-term satisfaction and successful treatment outcomes. Additionally, the culturally rich and hospitable environment of India adds to the overall positive experience for medical tourists, as (Kumar et al., 2021) note, contributing to the appeal of India as a dental tourism destination. Overall, this literature review illustrates that the Indian dental tourism sector is characterized by high patient satisfaction and successful treatment outcomes, underpinned by the quality of care, cost-effectiveness, and a patient-centered approach, further enhanced by the cultural and hospitality factors unique to India.

### Regulatory Standards in Medical Tourism

The regulatory landscape of medical tourism, including dental care services in India, is a critical area of focus. National and international regulations play a significant role in shaping this sector. Research often centres on how countries regulate medical tourism and enforce standards. International guidelines and standards, such as those set by the World Health Organization (WHO) or the Joint Commission International (JCI), are pivotal in ensuring consistent quality and safety across borders. Another key aspect is the quality of care and accreditation. Literature in this area explores the role of accreditation bodies in maintaining high standards in medical tourism. Specifically, studies might delve into how dental clinics in India are accredited and monitored, ensuring they meet global healthcare standards. Legal frameworks and patient rights are also crucial. This involves a review of legal protections for international patients, encompassing malpractice laws and mechanisms for dispute resolution. The literature often analyses the rights of patients and the processes for informed consent in cross-border healthcare scenarios.

### Ethical Standards in Medical Tourism

Ethical considerations in medical tourism, especially in dental care services, are complex and multifaceted. One primary concern is equity and access to healthcare. The literature examines the impact of medical tourism on local healthcare resources and the broader implications for healthcare equity. This includes a critical look at how medical tourism in countries like India affects healthcare access for both local and international populations. Transparency and informed consent are equally significant. Research in this field reviews the importance of providing patients with clear, transparent information regarding the risks, benefits, and alternatives of seeking medical treatment abroad. It discusses the ethical responsibilities of healthcare providers to ensure that patients are well-informed before making healthcare decisions. Lastly, cultural sensitivity and patient care is a prominent theme. Ethical considerations in providing care to a diverse international patient base, respecting their cultural and





Suzana Hasan Ali Alqafeai et al.,

language differences, are crucial. The literature often highlights best practices in delivering cross-cultural healthcare, ensuring that patient care is both respectful and effective.

### Economic Impact and Healthcare Implications

Medical tourism, a multi-billion-dollar industry, significantly impacts the economies of destination countries, as outlined by (Connell, 2013)(Turner, 2007). This sector not only enhances foreign exchange earnings and job creation but also stimulates the local economy, especially in countries like Thailand, India, and Singapore, where it's a major industry. However, (Bookman, 2007) caution against economic vulnerabilities that may arise from over-reliance on this sector. The healthcare implications in these countries are complex; Milstein and (Smith & Forgione, 2007)highlight that while medical tourism can lead to improved healthcare facilities, it may divert resources from local healthcare needs, exacerbating inequalities in healthcare access, a concern echoed by (Cohen, 2010).(Johnston et al., 2010) emphasize the importance of balancing the benefits of medical tourism with its potential negative impacts on healthcare systems. The quality of care and patient safety are also critical factors linked to the economic impact of medical tourism. The growth of this industry is partly due to the perceived high quality of care in certain countries, as(Lunt et al., 2010) note. Nonetheless, concerns persist about patient safety and post-operative care quality, as highlighted by(Snyder et al., 2013). This underscores the need for continuous care and addressing legal and ethical issues related to patient treatment. Furthermore,(Hall, 2011) and (Snyder et al., 2011) suggest that effective policy responses are required to promote medical tourism while safeguarding local healthcare interests and ensuring ethical practices and equitable access to healthcare.

### JUSTIFICATION FOR THE STUDY

The research on dental tourism in India is crucial due to the sector's significant economic impact and its growing role in the global medical tourism market. This study aims to:

1. **Evaluate Economic Contributions:** Understand how dental tourism contributes to India's economy and explore ways to enhance this impact.
2. **Assess Global Competitiveness:** Analyse India's position in the global market of medical tourism, identifying strengths and areas for improvement.
3. **Examine Healthcare Quality:** Investigate the quality of dental care offered to tourists, crucial for maintaining India's reputation as a premier medical tourism destination.
4. **Inform Policy:** Provide insights to aid policymakers in developing strategies that balance the growth of dental tourism with the needs of the local healthcare system.
5. **Address Research Gaps:** Fill the existing gap in literature by focusing specifically on dental tourism in India, contributing to both academic and practical understanding.
6. **Explore Ethical and Safety Issues:** Investigate ethical considerations and patient safety concerns in dental tourism, essential for its sustainable growth. This research aims to offer comprehensive insights into dental tourism in India, aiding stakeholders in enhancing the sector's development and addressing associated challenges.

### PURPOSE AND INTENT OF THE STUDY

The study aims to critically evaluate and outline the current state and potential growth of dental tourism in India. Key objectives include:

1. To examining the quality, affordability, and range of dental services available to international patients in India.
2. To understanding the factors fuelling the growth of this sector and the obstacles it faces.
3. To proposing actionable strategies for healthcare providers and policymakers to enhance the sector's competitiveness and sustainability.





Suzana Hasan Ali Alqafeai *et al.*,

4. To bridging gaps in existing literature and providing valuable insights for both academic research and industry practice in medical tourism.
5. To suggest policy recommendations and marketing strategies for promoting dental tourism in India.

This research is intended to offer a concise yet comprehensive overview of India's dental tourism market, supporting informed decision-making and strategic planning in this evolving field.

## RESEARCH METHODOLOGY

### Research Design

This study employs a mixed-methods approach, blending in-depth qualitative interviews and observations with quantitative analysis of secondary data, such as industry reports and patient statistics, to thoroughly understand dental tourism in India. It is an exploratory research endeavour, aimed at uncovering insights, patterns, and diverse aspects of the relatively unexplored field of dental tourism in the country. Central to the research is an exhaustive literature review, utilizing secondary resources. This review, conducted through searches on Google Scholar and other databases using terms like "medical tourism," "health tourism," and "dental tourism," focuses on understanding the various dimensions of dental tourism, including its practices, challenges, and benefits. This comprehensive review forms the foundation for subsequent primary data collection through expert interviews.

### Sample Design

For the study a purposeful sampling method is used, targeting dentists and managers in private hospitals in the Delhi NCR region who have direct experience with dental tourism. Selection criteria should emphasize professional experience, diverse roles, and representation from hospitals with a significant number of international patients.

### Data Collection

**Secondary Data Analysis:** Review and analyse existing literature, reports, and statistical data on dental tourism in India. This includes data from healthcare departments, tourism boards, and academic studies.

### Primary Data Collection

- **Qualitative Data:** Conduct structured interviews with key stakeholders such as dentists, hospital managers, and staff in the International Patient Services (IPS) departments in the Delhi NCR region. Observe operations in dental clinics and hospitals catering to international patients.
- **Quantitative Data:** Utilize available statistical data on patient inflow, revenue generated from dental tourism, and service satisfaction levels, if accessible.

## DISCUSSION

### Key factors of dental tourism

Considering the factors impacting the medical tourism market in India, this involves assessing the literature and engaging in discussions with experts in both the healthcare and academic fields. These factors are represented in figure 1.

### Hospital Infrastructure

Most of the patients who come to India are from developed countries, the structure of hospitals in India is equivalent to that of developed countries, and there is the option of exclusive sectors in hospitals for overseas patients called IPS(international patients services).India has international hospitals boasting the



**Suzana Hasan Ali Alqafeai et al.,**

best technology and high-quality equipment, yet there are certain flaws such as streets, sanitation and local utility services etc.

**Proficiency Of Doctors And Staff**

in Indian hospitals, the professional, expert, and talented workforce is capable of handling and managing any form of medical difficulty. Indian nurses are widely known as the best in the world. Doctors, surgeons, nurses, technicians, clinical coordinators, attendants, and nutritionists are among the trained and knowledgeable healthcare professionals who serve global medical tourists by performing complex surgeries and other medical and diagnostic treatments.

**Destination Culture**

There should be a method and possibilities to study the traditional lifestyles in India, and the competent authorities should organise many programmes for foreigners to learn about local history, as well as a specific programme for local people to open up and welcome individuals from other cultures.

**Marketing**

Currently, in this era of automation and development, marketing plays a significant role in attracting patients in all elements of visual and auditory media, as well as through the internet. They additionally set up a health camp under the banner of these Indian hospitals in countries with the highest number of patients, such as Iraq and Yemen, etc.

**Quality of treatment**

A significant number of hospitals in India deliver proper care in all medical specialities. Indian hospitals have the most advanced technology and high-quality equipment equivalent to those seen in advanced countries, the progress of technology has led to a rise in demand for medical services across geographical limitations to improve health quality.

**Cost-effectiveness**

Medical tourists can save from around 25% to 90% on medical costs, according to the service and the region to which they go. There are various elements at work here: Diagnostic testing and prescriptions are particularly costly in developed countries.

**ANALYSIS OF FINDINGS****Growth Factors, Challenges, and Strategic Responses:**

- The growth of India's dental tourism is primarily attributed to cost advantages, quality of care, and supportive government policies. However, challenges such as the need for international accreditation and effective marketing strategies are evident.
- To address these challenges, strategic responses could include enhancing international partnerships, improving accreditation standards, and developing targeted marketing campaigns to attract global patients.

**Comparative Advantage**

- India's comparative advantage in dental tourism lies in its cost-effectiveness, highly skilled medical professionals, and the integration of modern medical facilities.
- The unique combination of advanced dental care with the rich cultural experience of India also adds to its appeal as a preferred dental tourism destination.





Suzana Hasan Ali Alqafeai et al.,

### Patient Perspectives

- Patients are increasingly choosing India for dental care due to immediate treatment options, substantial cost savings, and the overall quality of care.
- Patient testimonials and feedback can provide insights into their experiences and satisfaction levels, which are crucial for understanding the strengths and weaknesses of India's dental tourism sector.

### Economic Impact

- Dental tourism significantly contributes to India's economy. The sector not only generates direct revenue from healthcare services but also indirectly boosts related industries like hospitality and travel.
- Future projections indicate robust growth, underscoring the sector's importance in India's economic landscape.

This analysis synthesizes the key findings of the research, offering insights into the factors driving the success of dental tourism in India and the challenges it faces.

### Comparison of Decision Tree

#### 1. Start of Decision Tree - Choosing a Dental Tourism Destination:

The decision-making process begins with the choice of a country for dental tourism.

#### 2. First Decision Point - Cost-Effectiveness:

The tree branches based on whether the country offers cost-effective dental treatment. India is known for its cost-effectiveness compared to Western countries.

#### 3. Second Decision Point - Quality of Care:

For destinations deemed cost-effective, the next consideration is the quality of dental care. India offers high-quality dental services, often on par with global standards.

#### 4. Third Decision Point - Range of Services:

Within the branch of high-quality care, the range of available dental services is the next consideration. India provides a wide range of dental services, from basic care to advanced procedures.

#### 5. Fourth Decision Point - Accessibility:

For countries with a wide range of services, ease of access, including travel connectivity, visa policies, and internal transportation, is evaluated. India scores well in terms of accessibility for medical tourists.

#### 6. Final Decision Point - Patient Satisfaction:

The last point in the decision tree is patient satisfaction, which includes treatment outcomes and overall experience. High patient satisfaction rates in India strengthen its position as a preferred destination.

This decision tree provides a comparative framework for patients considering their options for dental tourism. This decision tree effectively summarizes the decision-making process for a patient considering dental tourism. It highlights India's strengths in cost, quality, range of services, accessibility, and patient satisfaction, which are crucial factors influencing a patient's choice. By navigating through these decision points, a patient can make an informed decision based on their specific needs and preferences.

### MANAGERIAL IMPLICATIONS

The insights garnered from our analysis of India's dental tourism sector reveal critical areas for managerial intervention. In this context, we outline several key managerial implications to optimize the industry's growth and efficiency.





Suzana Hasan Ali Alqafeai *et al.*,

### **Strategic Marketing and Branding**

To enhance India's position in the global dental tourism market, strategic marketing and branding efforts are essential. This includes promoting India's cost-effectiveness, quality of care, and diverse range of services in international markets.

### **Strengthening International Partnerships**

Collaborating with international healthcare providers and tourism agencies can help in reaching a wider audience. Building partnerships can also facilitate smoother patient experiences, from travel to treatment.

### **Focus on Accreditation and Quality Standards**

To address challenges like international accreditation, Indian dental care providers should focus on meeting and maintaining high-quality standards. Obtaining international accreditation can further bolster India's reputation as a reliable dental tourism destination.

### **Enhancing Patient Experience**

Improving patient experience through personalized care, clear communication, and efficient post-treatment support can significantly boost patient satisfaction. Offering comprehensive packages that include dental care, accommodation, and cultural experiences can be attractive to medical tourists.

### **Policy and Infrastructure Development**

Government policies should continue to support and grow the dental tourism sector. This includes streamlining visa processes for medical tourists and investing in healthcare infrastructure and technology.

### **Utilizing Digital Platforms**

Leveraging digital platforms for marketing, patient engagement, and teleconsultations can widen the reach and improve accessibility for potential international patients.

### **Ethical Practices and Patient Rights**

Upholding high ethical standards and ensuring the rights and safety of international patients is crucial. This includes providing transparent information, maintaining privacy, and ensuring informed consent.

### **Economic Development and Job Creation**

Recognizing and capitalizing on the economic potential of dental tourism can lead to broader economic development and job creation in healthcare and related sectors.

### **Addressing Local Healthcare Needs**

It's important to balance the growth of dental tourism with the healthcare needs of the local population. Ensuring that resources are not diverted disproportionately is essential for sustainable growth in the sector.

### **Research and Development**

Continued research and development in dental care technologies and practices will keep India at the forefront of innovation in dental tourism.

Implementing these managerial implications can help India not only solidify its position as a leading destination for dental tourism but also ensure sustainable growth and development in this sector.







Suzana Hasan Ali Alqafeai et al.,

## SUGGESTIONS

In light of the findings from our comprehensive analysis of India's dental tourism sector, we propose several strategic recommendations aimed at enhancing the industry's growth and global competitiveness, here are concise suggestions:

1. **Strengthen International Partnerships:** Foster collaborations with global healthcare and tourism agencies to enhance India's dental tourism visibility.
2. **Targeted Marketing:** Utilize digital media to promote India's cost-effective and high-quality dental services.
3. **Focus on Quality and Accreditation:** Seek international accreditation for dental clinics to build global trust and maintain high care standards.
4. **Improve Patient Experience:** Offer comprehensive and personalized care packages, combining dental treatments with tourism experiences.
5. **Supportive Government Policies:** Advocate for policies that facilitate dental tourism, including streamlined visa processes and healthcare infrastructure investments.
6. **Uphold Ethical Practices:** Ensure transparent and ethical treatment of international patients, respecting their rights and privacy.
7. **Balance Local and International Care:** Ensure equitable healthcare resource allocation between local and international patients.
8. **Continuous Staff Training:** Invest in staff development to stay abreast of global dental care advancements.
9. **Foster Research and Innovation:** Encourage research in dental practices and technology to keep pace with global trends.
10. **Economic Development:** Utilize dental tourism growth for broader economic benefits, creating jobs in healthcare and allied sectors.

Implementing these suggestions can significantly enhance India's position in the global dental tourism market and ensure its sustainable growth.

## CONCLUSION

This study underscores India's emerging prominence in the global dental tourism market, driven by its cost-effectiveness, comprehensive service range, and accessibility. Despite these advantages, addressing challenges such as enhancing international accreditation and improving marketing strategies is essential for future growth. The high patient satisfaction rates and positive treatment outcomes reinforce India's position as a desirable destination for dental tourism. This research not only enriches the academic discourse but also provides practical insights for stakeholders, paving the way for further development and strategic enhancement of India's dental tourism sector.

## REFERENCES

1. Achilov, Y. (2021). *NEW PERSPECTIVES OF MEDICAL TOURISM IN INDIA* [DELHI TECHNOLOGICAL UNIVERSITY].
2. Adabi, K., Stern, C. S., Weichman, K. E., Garfein, E. S., Pothula, A., Draper, L., & Tepper, O. M. (2017). Population health implications of medical tourism. *Plastic and reconstructive surgery*, 140(1), 66-74.
3. Agrawal, A., & Gupta, A. (2020). Exploring the factors influencing the choice of oral care products: A review on personalized approach. *Int J Oral Dent Health*, 6(2).
4. Akbar, F. H., Rivai, F., Abdullah, A. Z., Awang, A. H., & Maretta, Y. A. (2020). Dental tourism: New strategies for the health care in Indonesia. *International Journal of Scientific and Technology Research*, 9(2), 1432-1433.





**Suzana Hasan Ali Alqafeai et al.,**

5. Awadzi, W., & Panda, D. (2006). Medical tourism: Globalization and the marketing of medical services. *Consortium Journal of Hospitality & Tourism*, 11(1).
6. Binoy, T., & Monisha, A. (2011). Dental Tourism Development in India: An Empirical Study. *Atna Journal of Tourism Studies*, 6(1), 65-83.
7. Bookman, M. (2007). *Medical tourism in developing countries*. Springer.
8. Campbell, A., Restrepo, C., & Navas, G. (2020). Patient satisfaction with medical tourism: a review of 460 international plastic surgery patients in Colombia. *Plastic and Reconstructive Surgery Global Open*, 8(12).
9. Carrera, P. M., & Bridges, J. F. (2006). Globalization and healthcare: understanding health and medical tourism. *Expert review of pharmacoeconomics & outcomes research*, 6(4), 447-454.
10. Cohen, I. G. (2010). Medical tourism: The view from ten thousand feet. *Hastings Center Report*, 40(2), 11-12.
11. Connell, J. (2006). Medical tourism: Sea, sun, sand and... surgery. *Tourism management*, 27(6), 1093-1100.
12. Connell, J. (2013). Contemporary medical tourism: Conceptualisation, culture and commodification. *Tourism management*, 34, 1-13.
13. Dang, H.-S., Nguyen, T.-M.-T., Wang, C.-N., Day, J.-D., & Dang, T. M. H. (2020). Grey system theory in the study of medical tourism industry and its economic impact. *International Journal of Environmental Research and Public Health*, 17(3), 961.
14. Dawn, S. K., & Pal, S. (2011). Medical tourism in India: issues, opportunities and designing strategies for growth and development. *International Journal of Multidisciplinary Research*, 1(3), 7-10.
15. DeMicco, F. J. (2017). *Medical tourism and wellness: hospitality bridging healthcare (H2H)*. CRC Press.
16. Dhakate, N., & Joshi, R. (2023). Classification of reviews of e-healthcare services to improve patient satisfaction: Insights from an emerging economy. *Journal of Business Research*, 164, 114015.
17. Dhama, K., Patthi, B., Singla, A., Gupta, R., Niraj, L. K., Ali, I., Kumar, J. K., & Prasad, M. (2016). Global tourist guide to oral care-A systematic review. *Journal of clinical and diagnostic research: JCDR*, 10(9), ZE01.
18. Ebrahim, A. H., & Ganguli, S. (2019). A comparative analysis of medical tourism competitiveness of India, Thailand and Singapore. *Tourism: An International Interdisciplinary Journal*, 67(2), 102-115.
19. Gahlinger, P. M. (2008). The medical tourism travel guide: Your complete reference to top-quality, low-cost dental, cosmetic, medical care & surgery overseas. (No Title).
20. Gaines, J., & Lee, C. V. (2019). Medical tourism. In *Travel medicine* (pp. 371-375). Elsevier.
21. Garg, S. R., & Bhardwaj, A. (2012). Indian medical tourism industry: growth opportunities and challenges. *Multi Disciplinary Edu Global Quest (Quarterly)*, 1(1), 115-135.
22. Gopalan, S. S., Mutasa, R., Friedman, J., & Das, A. (2014). Health sector demand-side financial incentives in low-and middle-income countries: a systematic review on demand-and supply-side effects. *Social Science & Medicine*, 100, 72-83.
23. Gupta, A. S. (2008). Medical tourism in India: winners and losers. *Indian Journal of Medical Ethics*, 5(1), 4-5.
24. Hall, C. M. (2011). Health and medical tourism: a kill or cure for global public health? *Tourism review*, 66(1/2), 4-15.
25. Hazarika, I. (2010). Medical tourism: its potential impact on the health workforce and health systems in India. *Health policy and planning*, 25(3), 248-251.
26. Heung, V. C., Kucukusta, D., & Song, H. (2011). Medical tourism development in Hong Kong: An assessment of the barriers. *Tourism management*, 32(5), 995-1005.
27. Heydari, M., Yousefi, M., Derakhshani, N., & Khodayari-Zarnaq, R. (2019). Factors affecting the satisfaction of medical tourists: A systematic review. *Health Scope*, 8(3).
28. Holliday, R., Jones, M., & Bell, D. (2019). *Beautyscapes: Mapping cosmetic surgery tourism*. In *Beautyscapes*. Manchester University Press.
29. Horowitz, M. D., Rosensweig, J. A., & Jones, C. A. (2007). Medical tourism: globalization of the healthcare marketplace. *Medscape General Medicine*, 9(4), 33.
30. John, J., & Chelat, S. (2013). Medical tourism and inclusive growth: significance of Ayurveda sector. *Atna Journal of Tourism Studies*, 8(2), 19-35.





**Suzana Hasan Ali Alqafeai et al.,**

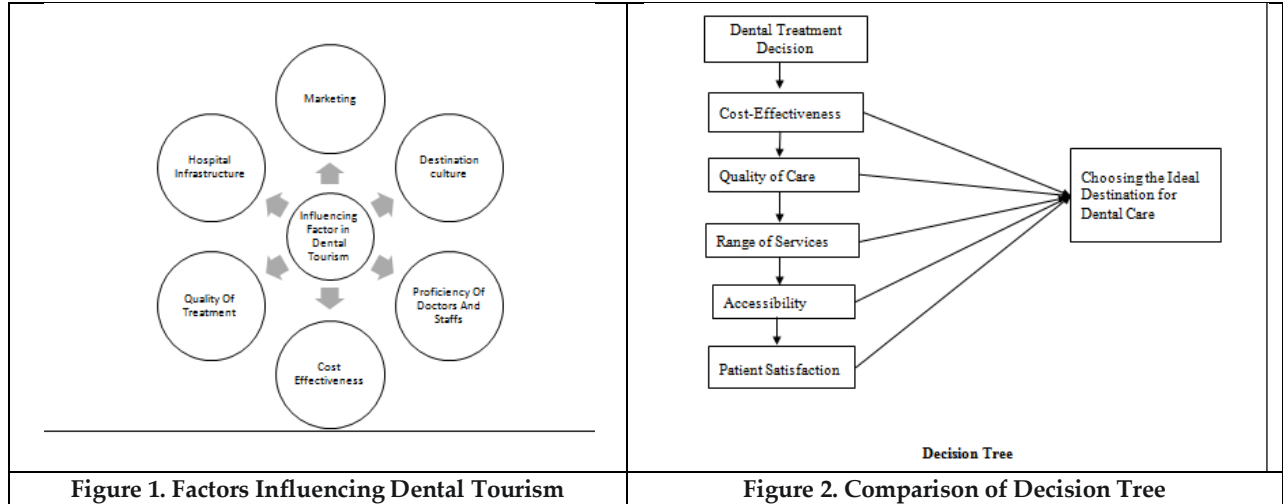
31. Johnston, R., Crooks, V. A., Snyder, J., & Kingsbury, P. (2010). What is known about the effects of medical tourism in destination and departure countries? A scoping review. *International Journal for Equity in Health*, 9(1), 1-13.
32. Kalshetti, P., & Pillai, D. (2008). Tourism products development and management medical tourism-A Shifting Paradigm.
33. Kamath, K., Hugar, S., Kumar, V., Gokhale, N., Uppin, C., & Hugar, S. S. (2015). The business and pleasure of teeth: Dental tourism. *International Journal of Contemporary Dental & Medical Reviews*, 2015.
34. Klein, H. J., Simic, D., Fuchs, N., Schweizer, R., Mehra, T., Giovanoli, P., & Plock, J. A. (2017). Complications after cosmetic surgery tourism. *Aesthetic surgery journal*, 37(4), 474-482.
35. Kumar, D., Bagchi, S., & Ray, S. (2021). Why Bangladeshi patients prefer outbound medical travel? an analytical study. *International Tourism and Hospitality Journal*, 4(6), 1-15.
36. Lunt, N., Hardey, M., & Mannion, R. (2010). Nip, tuck and click: medical tourism and the emergence of web-based health information. *The open medical informatics journal*, 4, 1.
37. Lunt, N., Horsfall, D., & Hanefeld, J. (2016). Medical tourism: A snapshot of evidence on treatment abroad. *Maturitas*, 88, 37-44.
38. Mason, A. (2023). Medical Tourism and Communication. In *Oxford Research Encyclopedia of Communication*.
39. Masoud, F., Alireza, J., Mahmoud, K., & Zahra, A. (2013). A systematic review of publications studies on medical tourism. *Journal of education and health promotion*, 2.
40. Mitra, P., & Chawla, R. (2016). Dental Tourism in India. An Update. *International Journal of Advanced Research*, 4(1), 1271-1275.
41. Muslim, T. A. (2016). *A comparative analysis of oral healthcare policy development between a developed country (Australia) and a developing country (South Africa)*
42. Raggio, B. S., Brody-Camp, S. A., Jawad, B. A., Winters, R. D., & Aslam, R. (2020). Complications associated with medical tourism for facial rejuvenation: a systematic review. *Aesthetic Plastic Surgery*, 44, 1058-1065.
43. Reddy, S., & Qadeer, I. (2010). Medical tourism in India: progress or predicament? *Economic and political weekly*, 69-75.
44. Singh, L., & Dhankhar, D. (2021). Travel behaviour post covid-19: an empirical study with reference to Indian tourists. *Journal of Tourism*, 22(2), 87.
45. Singh, R. S. D. M., & Saxena, S. K. (2020). Foreign Patient's Satisfaction from Hospitality Services–Medical Tourism at JCI Accredited Hospitals of Delhi-NCR, India. *International Journal of Psychosocial Rehabilitation*, 24(7), 4027-4035.
46. Smith, P. C., & Forgione, D. A. (2007). Global outsourcing of healthcare: a medical tourism decision model. *Journal of Information Technology Case and Application Research*, 9(3), 19-30.
47. Snyder, J., Crooks, V., Johnston, R., & Kingsbury, P. (2013). Beyond sun, sand, and stitches: assigning responsibility for the harms of medical tourism. *Bioethics*, 27(5), 233-242.
48. Snyder, J., Crooks, V. A., Johnston, R., & Kingsbury, P. (2011). What do we know about Canadian involvement in medical tourism? A scoping review. *Open Medicine*, 5(3), e139.
49. Telej, E., & Gamble, J. R. (2019). Yoga wellness tourism: a study of marketing strategies in India. *Journal of Consumer Marketing*, 36(6), 794-805.
50. Turner, L. (2007). 'First world health care at third world prices': globalization, bioethics and medical tourism. *BioSocieties*, 2(3), 303-325.
51. Turner, L. G. (2011). Quality in health care and globalization of health services: accreditation and regulatory oversight of medical tourism companies. *International Journal for Quality in Health Care*, 23(1), 1-7.
52. Wong, K. M., Velasamy, P., & Arshad, T. N. T. (2014). Medical tourism destination SWOT analysis: A case study of Malaysia, Thailand, Singapore and India. SHS web of conferences,
53. Yildiz, M. S., & Khan, M. M. (2016). Opportunities for reproductive tourism: cost and quality advantages of Turkey in the provision of in-vitro Fertilization (IVF) services. *BMC health services research*, 16, 1-8.
54. Zakaria, M., Islam, M. A., Islam, M. K., Begum, A., Poly, N. A., Cheng, F., & Xu, J. (2023). Determinants of Bangladeshi patients' decision-making process and satisfaction toward medical tourism in India. *Frontiers in Public Health*, 11, 1137929.





**Suzana Hasan Ali Alqafeai et al.,**

55. Zarei, A., Feiz, D., Maleki Minbashrazgah, M., & Maleki, F. (2020). Factors influencing selection of medical tourism destinations: A special niche market. *International Journal of Healthcare Management*, 13(sup1), 192-198.





## Laser in the Field of Dentistry – A Review

Ambikathanaya U.K.<sup>1\*</sup>, Sunil Tejaswi.K.L.<sup>2</sup> and Suneeth Shetty<sup>1</sup>

<sup>1</sup>Lecturer, Department of Conservative Dentistry and Endodontics, JSS Dental College and Hospital, JSS Academy of Higher Education and Research, Mysore, Karnataka, India.

<sup>2</sup>Reader, Department of Conservative Dentistry and Endodontics, JSS Dental College and Hospital, JSS Academy of Higher Education and Research, Mysore, Karnataka, India.

Received: 22 Jan 2024

Revised: 09 Feb 2024

Accepted: 04 May 2024

### \*Address for Correspondence

Ambikathanaya U.K

Lecturer,

Department of Conservative Dentistry,

JSS Dental College and Hospital,

JSS Academy of Higher Education and Research,

Mysore, Karnataka, India.

Email: ambikathanayauk@gmail.com



This is an Open Access Journal / article distributed under the terms of the **Creative Commons Attribution License** (CC BY-NC-ND 3.0) which permits unrestricted use, distribution, and reproduction in any medium, provided the original work is properly cited. All rights reserved.

### ABSTRACT

Lasers have been used in various fields. Advance in the field of science and technology laser had got prominent usage. It has got lot of advantages such that its application is used as an adjunct in various aspects. Laser in the field of dentistry had lot of contributions such as disinfection, cavity preparation, operculectomy, flap surgeries, freenectomy, bleaching and photo biomodulation. It is categorized into hard tissue and soft tissue laser. Soft tissue laser had made tremendous usage in the field of dentistry, where as hard tissue laser because of its cost effectiveness and mode of application is difficult, its usage is restricted. Therefore this review gives adequate information regarding soft tissue lasers and its field of application.

**Keywords:** Microbes, Smear Layer, Irrigation, Disinfection

## INTRODUCTION

'LASER' is an acronym for Light Amplification by Stimulated Emission of Radiation. It has some properties such as when its comes in contact with biological tissue it gets absorbed mainly due to presence of free water molecules, proteins, pigments and other macromolecules. Absorption mainly depends on wavelength of the incoming laser irradiation. The absorption coefficient for water is 0.00029, for argon laser (514nm),0.020, for diode laser(800nm).0.61, for Nd:YAG laser(1.064nm),12000 for Er:YAG laser(2,940nm) and 860 for CO<sub>2</sub> laser (10,600nm). [1] Therefore the usage of each laser depends upon the area of application.



**Ambikathanaya et al.,****LASER APPLICATION IN THE FIELD OF ROOT CANAL THERAPY**

Root canal system is divided into 3 equal parts. Cervical, middle and apical 1/3<sup>rd</sup>. Remnants within the apical 1/3<sup>rd</sup> is the prime cause for RCT failure. The main cause for endodontic treatment failure is intra radicular or extra radicular infection, foreign body reaction, cyst formation and fibrous scar tissue healing.[2 ,3]Necrotic tissue and microorganisms removal from the root canal is the main objective of root canal treatment. Endodontic space disinfection depends mainly on chemo mechanical action. It mainly depends on the technique of irrigation that is the way it is delivered and agitated in the root canal. The efficacy of each irrigants is improved using different agitation technique such as hand files, sonic, ultrasonic and laser device. Lasers improves the penetration ability which enhance apical ramification cleansing action. [4]\_The disinfection action of lasers depends on the type of bacteria present. Pigmented and non pigmented bacteria. Non pigmented bacteria were shown to be transparent and had bactericidal effect through heating of the environment of bacteria whereas the pigmented bacteria gets exposed to the laser light source which results in bactericidal effect.[5]E- faecalis and C.albicans are more resistant to laser activation where laser energy is increased to reduce the intra-radicular microorganisms and results in root canal treatment success.[6]The efficacy of laser is improved when laser tip is placed apically 5mm from the coronal access. As the laser power is increased, fluid motion near the fiber tip is also increased.[7] This indicates that more apical placement of laser fiber tip results in better decontamination.[8] Turbulent action of irrigant within the canal after activation with lasers help in removal of remnants.[9] Recent studies shown that irrigating solutions had more efficacy when its get activated with lasers, ultrasound, files and other systems.

**DIFFERENT TYPES OF LASERS USED IN THE FIELD OF DENTISTRY****Nd:YAG Lasers**

It is used in dentin hypersensitivity cases where laser induced occlusion or narrowing of dentinal tubules as well as direct nerve analgesia.

**Diode lasers**

It is used only on soft tissues procedures such as ginivectomy, biopsy, impression troughing and freenectomy which had a wave length of 805 to 1064nm

**CO<sub>2</sub> lasers**

it is used in incision and remodeling of soft tissues such as incisional and excisional biopsies, freenectomy ,gingivectomy, pre and prosthetic procedures which results in excellent homeostasis.

**Er: YAG**

It is used on both hard and soft tissues owing to their absorption scale that works for both apatite crystal based on maximum absorption by water content of soft and hard tissue.

**Helium- Neon laser**

He-Ne laser irradiation affects the nature of the stimuli. Effectiveness of treatment falls between 5.2% and 100%

**GaAIs laser**

It creates analgesic effect related to depressed nerve transmission. Studies showed blocking depolarization in C-fiber afferents when GaAIs laser were used at 830nm.

**Co<sub>2</sub> Laser**

1 to 2 W with CW or pulse mode can be advised. Dentinal tubules sealing achieved in addition to the reduction of permeability.





**Ambikathanaya et al.,**

#### **Nd: YAG laser**

It is used in dentinal hypersensitivity where it results in laser induced occlusion or narrowing of dentinal tubules as well as direct nerve analgesia

#### **Er: YAG Laser**

It is used in the ranges between 38.2% - 47% seals dentinal tubules exert nerve analgesia and reduce the pain originated from dentinal hypersensitivity.

### **DIAGNOSIS OF PULPAL VITALITY USING LASERS**

#### **Dual wavelength spectrophotometry**

Dual wavelength spectrophotometry [DWS] is used to test the pulpal blood flow. Oxygen saturation level in vascular supply of pulp is evaluated by a spectrophotometer that uses simultaneously released beams [ 760 & 850 nm]. Devital or degenerative status of pulp can be detected using this instrument.

#### **Laser Doppler flowmetry**

LDF is an accurate, non invasive reproducible reliable method of assessing blood flow in micro vascular systems with a diode. When light beam passes through the crown and pulp chamber, moving red cells and static tissues cause light beam to scatter around. The frequency of this light beam shifts when it passes through the moving red blood cells; however it remains steady when the beam passes through static tissues. Drawback is it takes a long time an hour to produce recordings, and this makes it impractical for dental practices.

#### **Lasers in dentin hypersensitivity treatment**

1. Low out put power [Low- level] lasers are [helium- neon(He-Ne) and gallium –aluminarsenide (Diode) lasers(GaAIAs)]
2. Middle out put power lasers are [Co<sub>2</sub> laser, neodymium or erbium –doped yttrium aluminum garnet (Nd:YAG, Er: YAG lasers) and erbium,chromium doped: yttrium, scandium, gallium and garnet[ erbium, Cr:YSGG] Lasers] [10]

#### **Laser applications in endodontic surgery**

It provides a clean visual of the operative area without blood contamination where lasers vaporize the tissues, to coagulate and seal small blood vessels. It is thought that laser irradiated dentin surface are sterile and sealed.[11]

### **LASER APPLICATION IN THE FIELD OF DISINFECTION**

CO<sub>2</sub> laser was useful to remove smear layer, and Er: YAG laser was proved to be more effective.[12, 13] The most effective laser system in canal disinfection is Er: YAG laser since it has highest absorption level in water. Photo activated disinfection [PAD] was bactericidal because of its combined use of photosensitizing agent and low power laser. Bacteria's were not eliminated totally when compare to 3% of NaOCl which eradicate all microbes.[14,15] Debriding and cleaning efficacy of irrigation was enhanced by a new erbium laser technique coupled with a photon induced photo acoustic streaming [PIPS] specific minimally ablative laser and with specially designed tips. It creates strong photo acoustic shockwave that streams irrigants three dimensionally throughout the root canal system without thermal effect.[16] It activates the irrigation solution indirectly without thermal effect. This technique requires continuous flow of irrigating solution from the dental syringe. Pulp chamber must be flooded with adequate irrigating solution such that tips of the pips must be submerged. The 30 second cycles is required for adequate disinfection process followed by saline /water for final obturation process. [17] Microfloral composition within the canal remains based on the availability of oxygen and nutrients along with the host immune defense system. Among these microbes anaerobes are the dominant species. Most resistant species is the enterococcus faecalis which has the ability to penetrate inside the dentinal tubules that reach the depth of approximately 1000µm. As a gold standard in endodontic therapy NaOCl penetrate to root dentinal tubules up to 130µm.





**Ambikathanaya et al.,**

**Finally the successful elimination of endodontic infection depends on the following factors such as**

1. host defense system
2. systemic antibiotic therapy
3. Chemo mechanical preparation
4. local root canal disinfecting medicaments
5. root canal obturation
6. permanent restoration to achieve coronal seal.

Lasers in endodontics has predominant effect based on photo thermal effect. It disinfect the canal both by means of physical and chemical effect where reaction rate of NaOCl increases upon activation. Apart from photo thermal effect alternate method that have been developed is the antimicrobial photodynamic therapy[PDT] where photo sensitizer is applied inside the root canal and after particular incubation period the canal is irradiated by a light source where the wavelength of which coincides with the absorption band maximum of the photo sensitizer. Reactive oxygen species and singlet oxygen production takes place in the presence of oxygen that leads to microbial cell damage.[18] A study has mentioned that carious dentin absorbs 1064nm more wavelength in comparison to healthy dentin, which increases the desired bactericidal effect Laser supported root canal treatment is necessary for reducing reinfection in the root canal after smear layer modification. It reduces the microleakage after root canal fillings. A disinfecting solution combined with laser effectively remove and reduce any remaining bacteria and residual tissue. The laser beam from the end of the fiber passes and hit the root canal wall at an acute angle. The angle between glass fiber and dentin wall remains acute angle [5°]. The dentin surface also plays a role in terms of bactericidal effect. Darker area causes carbonization and requires high laser energy absorption. [19]

## CONCLUSION

Laser in the field of dentistry had brought changes in disinfection of the canal, surrounding tissues and other mode of applications which enhances healing and helps in better post operative care. It can be used as an adjunct to conventional root canal therapy but it can't be a substitute.

## REFERENCES

1. Zahed Mohammadi, Hamedan Laser application in endodontics: an update review International Dental Journal 2009;59:35-46.
2. Nair PNR, Pathogenesis of apical periodontitis and the causes of endodontic failures. Crit Rev Oral Biol Med 2004;15:348-381.
3. Pinheiro ET, Gomes BP, Feraz CC, Sousa EL,Teixeira FB,Souza Filho FJ Microorganisms from canals of root filled teeth with periapical lesions. Int Endod J 2003;36:1-11
4. Gu LS, Kim JR,Ling J, Choi KK,Pashley DH, Tay FR Review of contemporary irrigant agitation techniques and devices J Endod 2009;35:791-804.
5. Pirnat S, Lukcac M,Ihan A study of the direct bactericidal effect of Nd:YAG and diode laser parameters used in endodontics on pigmented and non pigmented bacteria Lasers Med Sci 2011;26:755-761.
6. Asnaashari M, Safavi N, Disinfection of contaminated canals by different laser wavelengths while performing root canal therapy . J Lasers Med Sci 2013;4:8-16
7. de Groot SD,Verhaagen B, Versluis M,Wu MK , Wesse-link PR ,van der Sluis L W. Laser activated irrigation within root canals: cleaning efficacy and flow visualization. Int Endod J 2009;42:1077-1083
8. Peeters HH, De Moor RJ Measurement of pressure changes during laser activated irrigant by an erbium, chromium: Ytrium,scandium, gallium,garnet laser. Lasers Med Sci 2015;30:1449-1455.
9. Demeyer S, Meireie MA, Coenye T,De Moor R J Effect of lasers activated irrigation on biofilms in artificial root canals. Int Endodod J 2016.DOI: 10.1111/iej.12643





**Ambikathanaya et al.,**

10. Emrah Cetin, Hicran Donmez Ozkan , Senem Gokcen Yigit Ozer Dental lasers and application fields in Endodontics 2017 Meandros Med Dent J ;18:1-7
11. Kimura Y, Wilder Smith P Matsumoto K , Lasers in Endodontics : a review. Int Endod J 2000;33:173-85.
12. Pashley EL, Horner JA, Liu M, Kim S, Pashley DH, Effects of CO2 laser energy on dentin permeability. J Endod 1992;18:257-62.
13. Pecora JD ,Brugnera – Junior A, Cussioli AL, Zanin F, Silva R Evaluation of dentin root canal permeability after instrumentation and Er: YAG laser application. Lasers Surg Med 2000;26:277-81.
14. Seal GJ, Ng YL, Spratt D, Bhatti M, Gulabivala K. An in vitro comparison of the bactericidal efficacy of lethal photo sensitization or sodium hypochlorite irrigation on streptococcus intermedius biofilms in root canals. Int Endod J 2002;35:268-74.
15. George R, Meyers I A, Walsh LJ. Laser activation of endodontic irrigants with improved conical laser fiber tips for removing smear layer in the apical third of the root canal. J Endod 2008;34:1524-7.
16. Divito E, Peters OA ,Olivi G, Effectiveness of the erbium : YAG laser and new design radial and stripped tips in removing the smear layer after root canal instrumentation. Laser Med Sci 2012;27:273-80.
17. Basrani B. Irrigation in endodontic treatments. Alpha Omegan 2011;104:18-25
18. Eugenia Anagnostaki, Valina Mylona, Steven Parker, Edward Lynch Systematic Review on the role of lasers in endodontic therapy: valuable adjunct treatment Dent Journal 2020;63(8):3-18.
19. Yves Saydjari , Thorsten Kuypers, Norbert Gutknecht Laser application in Dentistry : Irradiation effects of Nd: YAG 1064nm and Diode 810 nm and 980 nm in infected Root canals – A literature Overview BioMed Research International 2016 <http://dx.doi.org/10.1155/2016/8421656>.





# Outranking Approach for Modified Neutrosophic Technique with ELECTRE Multi-Criteria Decision Making Method in Agricultural Investment

R. Sophia Porchelvi<sup>1\*</sup> and S. Rubeela Mary<sup>2</sup>

<sup>1</sup>Associate Professor, Department of Mathematics, A.D.M College for Women (Autonomous), Nagapattinam (Affiliated to Bharathidasan University), Tiruchirappalli, Tamil Nadu, India.

<sup>2</sup>Assistant Professor, Department of Mathematics, Idhaya College for Women, Kumbakonam (Affiliated to Bharathidasan University), Tiruchirappalli, Tamil Nadu, India.

Received: 09 Dec 2024

Revised: 10 Apr 2024

Accepted: 20 May 2024

## \*Address for Correspondence

**R. Sophia Porchelvi**

Associate Professor,

Department of Mathematics,

A.D.M College for Women (Autonomous),

Nagapattinam (Affiliated to Bharathidasan University),

Tiruchirappalli, Tamil Nadu, India.

Email: sophiaporchelvi@gmail.com



This is an Open Access Journal / article distributed under the terms of the **Creative Commons Attribution License** (CC BY-NC-ND 3.0) which permits unrestricted use, distribution, and reproduction in any medium, provided the original work is properly cited. All rights reserved.

## ABSTRACT

This paper focuses on to get more profit in agricultural investment. The conventional agricultural system heavily depends on chemicals and inorganic fertilizers, which cause environmental issues. Here the linguistic variables are converted to Neutrosophic set and it is solved by using proposed ELCTRE method in Multi criteria decision Making method.

**Keywords:** Neutrosophic Set, ELECTRE method, Ranking.

## INTRODUCTION

Decision making problem plays a major role in real life applications [4]. The concept of Neutrosophic sets was introduced by Smarandache in the year 1999[10]. A new method is proposed by Zhang. Z, Wu. C [12] to solve single valued Neutrosophic multi criteria decision making under incomplete weight information. Deli and Subas [2] proposed a ranking method for single valued neutrosophic numbers and Peng et al.[6] developed single valued neutrosophic sets an action to handle MCDM problems. In 1977, ELECTRE method was first developed by Benayoun, Roy and Sussmann [1]. Vahdani and Hadipour [11] introduced an extended ELCTRE problem with interval-valued fuzzy information.





**Sophia Porchelvi and Rubeela Mary**

The remaining paper is as follows: The basic definitions of Neutrosophic set is discussed in section 2. Section 3 introduces the proposed ELECTRE method & its example. Comparison Analysis is studied in section 4. Section 5 presents conclusion.

**Preliminaries**

This section presents the basic definition of SVNNSs.

**Definition 2.1 [7]**

Let  $X$  be a non-empty set. A neutrosophic set  $A$  in  $X$  is characterized by truth-membership function  $T_A$ , indeterminacy-membership function  $I_A$  and falsity – membership function  $F_A$ .  $T_A, I_A, F_A$  are real standard or non-standard subsets of  $]^{-}0, 1^{+}[$ . That is

$$\begin{aligned} T_A: X &\rightarrow ]^{-}0, 1^{+}[ \\ I_A: X &\rightarrow ]^{-}0, 1^{+}[ \\ F_A: X &\rightarrow ]^{-}0, 1^{+}[ \end{aligned}$$

There is no restriction on the sum of  $T_A(X), I_A(X), F_A(X)$ , so  $0 \leq T_A(X) + I_A(X) + F_A(X) \leq 3^+$

**Definition 2.2[9]**

Let  $X$  be a non-empty set. A single valued neutrosophic set (SVNS)  $A$  in  $X$  is characterized by truth-membership function  $T_A$ , falsity – membership function  $F_A$  and indeterminacy-membership function  $I_A$ . For each point  $x$  in  $X$ ,  $T_A(x), F_A(x), I_A(x) \in [0,1]$ . A SVNS  $A$  can be written as  $A = \{x, T_A(x), I_A(x), F_A(x) : x \in X, T_A(x), I_A(x), F_A(x) \in [0,1]\}$ .

**Definition 2.3[2]**

For a single valued neutrosophic set (SVNS)  $A = \{x, T_A(x), I_A(x), F_A(x) : x \in X, T_A(x), I_A(x), F_A(x) \in [0,1]\}$  in  $X$ , the triplets  $T_A(x), I_A(x), F_A(x)$  is called single valued neutrosophic number (SVNN), which is the fundamental element of a SVNS  $A$ .

**METHODOLOGY**

MCDM plays vital role in ELCTRE approach [5]. This section is divided into two subsections. The first subsection presents the idea of proposed ELCTRE method and the second proposes illustrative example.

**The Proposed ELECTRE Based outranking Method for MCDM under Neutrosophic**

In Multi criteria evaluation techniques Neutrosophic ELECTRE is one of the earliest methods among other outranking methods [5]. Here decision –making problem can be considered which consists of  $m$  alternatives that must be assessed considering  $n$  criteria, and  $a_{ij}$  can be expressed as the value of  $i^{th}$  alternative by the  $j^{th}$  criteria.

Proposed ELECTRE Method has been described as following steps.

Step 1: Forming of Decision- making matrix (DMM)

$$\begin{bmatrix} a_{11} & a_{12}, \dots & a_{1n} \\ a_{21} & a_{22}, \dots & a_{2n} \\ \dots & \dots & \dots \\ a_{m1} & a_{m2}, \dots & a_{mn} \end{bmatrix}$$

where  $i=1$  to  $m$  &  $j=1$  to  $n$  and  $a_{ij}$  = value of an  $i^{th}$  alternative to the  $j^{th}$  criteria.

Step 2: Calculate Normalized decision matrix & Weighted Normalized decision matrix.

$$r_{ij} = \frac{a_{ij}}{\sqrt{\sum_{i=1}^m a_{ij}^2}}, \text{ where } i=1,2,3,\dots,m; j=1,2,3,\dots,n$$

$$R = \begin{bmatrix} r_{11} & r_{12}, \dots & r_{1n} \\ r_{21} & r_{22}, \dots & r_{2n} \\ \dots & \dots & \dots \\ r_{m1} & r_{m2}, \dots & r_{mn} \end{bmatrix} \rightarrow \textcircled{2} \quad \text{and} \quad W_{ij} = R \otimes \omega = \begin{bmatrix} r_{11} \cdot \omega_1 & r_{12} \cdot \omega_2, \dots & r_{1n} \cdot \omega_n \\ r_{21} \cdot \omega_1 & r_{22} \cdot \omega_2, \dots & r_{2n} \cdot \omega_n \\ \dots & \dots & \dots \\ r_{m1} \cdot \omega_1 & r_{m2} \cdot \omega_2, \dots & r_{mn} \cdot \omega_n \end{bmatrix} \rightarrow \textcircled{3}$$





**Sophia Porchelvi and Rubeela Mary**

Step 3: Calculate concordance and discordance sets

$$C_{xy} = \{j | a_{xj} \geq a_{yj}\}$$

$$D_{xy} = \{j | a_{xj} < a_{yj}\}$$

Step 4 : Formulate the concordance interval matrix

$$C_{xy}^1 = \sum_{j \in C_{xy}} \omega_{j1}, C_{xy}^2 = \sum_{j \in C_{xy}} \omega_{j2}, C_{xy}^3 = \sum_{j \in C_{xy}} \omega_{j3}$$

The concordance index indicates the preference of the assertion "A outranks B". The concordance interval matrix can be formulated as follows

$$C = \begin{pmatrix} - & c(1,2), \dots & c(1,n) \\ c(2,1) & - , \dots & c(2,n) \\ \dots & \dots & \dots \\ c(m,1) & c(m,2), \dots & c(m,n) \end{pmatrix} \rightarrow \textcircled{4}$$

Step 5: Formulate the discordance interval matrix

Find  $d(x, y)$  by using  $d(x, y) = \frac{\max_{j \in D_{xy}} |W_{xj} - W_{yj}|}{\max_{j \in \{j, m, n \in I\}} |W_{nj} - W_{mj}|}$  with the help of  $d(x, y)$  formulate D by the Equation  $\textcircled{5}$

$$D = \begin{pmatrix} - & d(1,2), \dots & d(1,n) \\ d(2,1) & - , \dots & d(2,n) \\ \dots & \dots & \dots \\ d(m,1) & d(m,2), \dots & d(m,n) \end{pmatrix} \rightarrow \textcircled{5}$$

Step 6 : Calculate the Concordance index matrix.

$$\bar{c} = \sum_{x=1}^n \sum_y^n \frac{c(x, y)}{n(n-1)} \rightarrow \textcircled{6}$$

where  $\bar{c}$  is the critical value, it can be determined by using average dominance index.

Boolean matrix E is defined by:

$$\begin{cases} e(x, y) = 1 & \text{if } c(x, y) \geq \bar{c} \\ e(x, y) = 0 & \text{if } c(x, y) < \bar{c} \end{cases}$$

Step 7: Calculate the discordance index matrix

$$\bar{d} = \sum_{x=1}^n \sum_y^n \frac{d(x, y)}{n(n-1)} \rightarrow \textcircled{7}$$

According to the discordance index defined above the discordance index matrix f is given by

$$\begin{cases} f(x, y) = 1 & \text{if } d(x, y) \leq \bar{d} \\ f(x, y) = 0 & \text{if } d(x, y) > \bar{d} \end{cases}$$

Step 8: The net superior  $c_a$  and net inferior  $d_a$  is calculated as follows

$$c_a = \sum_{b=1}^m C_{(a,b)} - \sum_{b=1}^m C_{(b,a)} \rightarrow \textcircled{8}$$

$$d_a = \sum_{b=1}^m D_{(a,b)} - \sum_{b=1}^m D_{(b,a)} \rightarrow \textcircled{9}$$

where  $c_a$  represents the sum of number of competitive superiority and  $d_a$  is used to find the number of inferiority ranking alternatives.

Step 9: Determine the preference of the alternatives.

$$R_{ij} = c_{ij} - d_{ij} \rightarrow \textcircled{10}$$

The highest value  $R_{ij}$  represents highest preference of the alternatives.

**Illustrative Example**

An example is given to explain MCDM problem and mainly aims to select the best agricultural profitable investment. A farmer aims to do profitable investment in his agricultural field inorder to get maximum profits out of organic or inorganic food crops. It involves many criteria and it must be considered before a investment decision.





### Sophia Porchelvi and Rubeela Mary

In this section, an illustrative example is constructed to explain a practical application of MCDM problem with neutrosophic ELECTRE is presented. This application aims to selecting the best agricultural profitable investment decision under MCDM neutrosophic ELECTRE. The criterion are Crop Diversity ( $C_1$ ), Crop Rotation ( $C_2$ ), Biological Pest Control ( $C_3$ ), Soil Management ( $C_4$ ), Green Manure ( $C_5$ ), Weed Management ( $C_6$ ), Effects of Human Health ( $C_7$ ), Effects of flora and fauna ( $C_8$ ), and the alternatives are Cereals ( $A_1$ ), Millets ( $A_2$ ), Oilseeds ( $A_3$ ), Pulses ( $A_4$ ), Cotton ( $A_5$ ), Vegetables ( $A_6$ ). In Table 1 linguistic variables in neutrosophic set and Table 2 shows the linguistic evaluation for the alternatives with respect to criteria.

Change the linguistic variables in to a Neutrosophic number based on the assessment of alternatives with respect to criteria. Each element has to be normalized with the help of ②. Normalized decision matrix is shown as in Table 3.

With the help of the equation④ the concordance matrix is calculated and it is shown in Table 4.

By using ⑤ discordance matrix is calculated and it is shown in Table 5 From the above table 6,  $A_1$  is the best alternative &  $A_4$  is the Worst alternative. The proposed ELECTRE method furnishes an analytic approach to shrink the number of alternatives and to simplify the decision making process.

#### Comparison Analysis of Proposed ELECTRE Method

This section provides a comparison analysis Proposed ELECTRE method with Ranking methods of SVNNS [3]. The Proposed ELECTRE approach is more flexible and provides foremost results for selecting the best alternative alternatives under Neutrosophic set. For comparison analysis, Let's consider an example of the Ranking method using SVNNS method has been considered. 5 Criteria & 4 Alternatives are taken in to account. Using the proposed ELECTRE method & Ranking method of SVNNS, the result obtained is From Table 7, we identified both the methods having the Rank 1 as same.

## CONCLUSION

This paper presents multi criteria analysis decision analysis. This analysis procedure effective evaluating performance in agricultural investment. An example is presented to show the effectiveness and accurateness of the Proposed ELECTRE method. This method is much simple to handle the problems to solve in order to find solution in today's life.

## REFERENCES

1. Benayoun, R., Roy, B., and Sussman, B., (1966), "ELECTRE: Une method pour guider le choix en presence de points de vue multiples", Note de travail, vol.49.
2. Deli, I., Subas, Y., (2016), "A ranking method of single valued neutrosophic numbers and its applications to multi attribute decision making problems", Int J Mach Learn Cybern 2: 1-14.
3. Dragisa Stanujkic., Leva Meidute - Kavaliauskiene., Darjan Karabasevic., (2019), "Ranking methods of Single valued neutrosophic numbers and its application to multiple criteria decision making", EEE.
4. Hossein Sayyadi Tooranloo., Seyes Mahmood Zanjirchi., and Mahtab Tavangar., (2020), "ELECTRE Approach for Multi-attribute Decision-making in Refined Neutrosophic Environment", Neutrosophic Sets and Systems, vol.3.
5. Ji, P., Zhang, H.Y., and Wang, W.Q., (2018), "Selecting an outsourcing provider based on the combined MABAC-ELECTRE method using single-valued neutrosophic linguistic sets" Comput. Ind. Eng, vol. 120, pp. 429-441.
6. Peng, J.J., Wang, Y.Q., Wang, J., Zhang, H.Y., Chen, X.H., (2016), "Simplified neutrosophic sets and their applications in multi-criteria group decision-making problems", Int. J. Syst. Sci. 47(10):2342-2358.
7. Roy, B., (1973), "How the outranking relation helps multiple criteria decision making", In: Multiple Criteria Decision Making, Cochrane and Zeleny (Eds.), University of South Carolina Press, SC, 179-201.
8. Sitorus, F., Cilliers, J.J., and Brito - Parada, P.R., (2008), "Multi-criteria decision making for the choice of problem in mining and mineral processing: Applications and trends", Experts Syst. Appl., 121, 393-417.





**Sophia Porchelvi and Rubeela Mary**

9. Smarandache, F., (1998), "Neutrosophy: Neutrosophic Probability, Set, and Logic, ProQuest Information & Learning; LearnQuest: Ann Arbor, MI, USA, 1998.
10. Smarandache, F., (1999), "A Unifying Field in Logics. Neutrosophy: Neutrosophic Probability Set and Logic", American Research Press: Rehoboth, DE, USA, pp.141.
11. Vahdani, B., Hadipour, H., (2011), "Extension of the ELECTRE method based on Interval - valued fuzzy sets", Soft Comput 15:569-579
12. Zhang, Z., Wu, C., (2014), "A Novel Method for Single-valued Neutrosophic Multi- Criteria Decision Making With Incomplete Weight Information", Neutrosophic Sets & Systems, 4, 35-49.

**Table 1: Linguistic variables of Criteria and Alternatives**

very Poor (VP)	0	0	1
Poor(P)	0	0.1	0.3
Medium Poor(MP)	0.1	0.3	0.5
Fair(F)	0.3	0.5	0.7
Medium Good(MG)	0.5	0.7	0.9
Good(G)	0.7	0.9	1
Very Good (VG)	0.9	0.1	0.1

**Table 2: Assessment of alternatives with respect to criteria**

Alternatives	Criteria							
	CD	CR	BPC	SM	GM	WM	EHH	EFF
A <sub>1</sub>	G	VG	MG	VG	MP	VG	VG	MG
A <sub>2</sub>	MG	G	F	MG	MP	VG	VG	MG
A <sub>3</sub>	G	G	F	G	P	MG	VG	G
A <sub>4</sub>	F	MP	G	MG	G	P	MG	MG
A <sub>5</sub>	MG	MG	VG	G	MG	P	P	MG
A <sub>6</sub>	MP	VP	MG	MP	G	VP	F	G

**Table 3: Normalized Decision Matrix**

	C <sub>1</sub>	C <sub>2</sub>	C <sub>3</sub>	C <sub>4</sub>	C <sub>5</sub>	C <sub>6</sub>	C <sub>7</sub>	C <sub>8</sub>
A <sub>1</sub>	0.1989	0.4122	0.2859	0.4279	0.4246	0.3626	0.3721	0.3205
A <sub>2</sub>	0.2984	0.1891	0.3691	0.2945	0.4246	0.3626	0.3721	0.3205
A <sub>3</sub>	0.1989	0.1891	0.3691	0.1964	0.4725	0.2495	0.3721	0.2136
A <sub>4</sub>	0.3852	0.4334	0.1906	0.2945	0.1853	0.4241	0.2561	0.3205
A <sub>5</sub>	0.2984	0.2837	0.4154	0.1964	0.278	0.4241	0.4353	0.3205
A <sub>6</sub>	0.4558	0.4229	0.2859	0.4499	0.1853	0.372	0.3307	0.2136

**Table 4: Concordance Matrix**

	A <sub>1</sub>	A <sub>2</sub>	A <sub>3</sub>	A <sub>4</sub>	A <sub>5</sub>	A <sub>6</sub>	sum
A <sub>1</sub>	0	0.32619	0.29444	0.29762	0.21984	0.22857	1.3667
A <sub>2</sub>	0.3119	0	0.34048	0.29762	0.22857	0.22857	1.4071
A <sub>3</sub>	0.2127	0.20397	0	0.1754	0.1381	0.22857	0.9587
A <sub>4</sub>	0.16508	0.23413	0.23413	0	0.23413	0.19683	1.0643
A <sub>5</sub>	0.24286	0.27143	0.34048	0.2746	0	0.2746	1.404
A <sub>6</sub>	0.22698	0.18095	0.34048	0.28175	0.13492	0	1.1651
Sum	1.15952	1.21667	1.55	1.32698	0.95556	1.15714	7.3659





**Sophia Porchelvi and Rubeela Mary**

**Table 5: Discordance Matrix**

	A <sub>1</sub>	A <sub>2</sub>	A <sub>3</sub>	A <sub>4</sub>	A <sub>5</sub>	A <sub>6</sub>	Sum
A <sub>1</sub>	0	0.4157	0.23948	0.42055	0.37277	0.57988	2.02838
A <sub>2</sub>	1	0	0	0.42233	0.37641	0.64928	2.44801
A <sub>3</sub>	1	1	0	0.40534	0.59845	0.88297	3.88677
A <sub>4</sub>	1	1	1	0	1	1	5
A <sub>5</sub>	1	0.753959	1	0.627155	0	1	4.38111
A <sub>6</sub>	1	1	1	0.529466	0.365451	0	3.89492
Sum	5	4.169663	3.239476	2.404841	2.713088	4.112127	0.72131

**Table 6 represent Net superior, Net inferior and their rank values using the Equ ⑥**

	A <sub>1</sub>	A <sub>2</sub>	A <sub>3</sub>	A <sub>4</sub>	A <sub>5</sub>	A <sub>6</sub>	Sum
A <sub>1</sub>	0	0.4157	0.23948	0.42055	0.37277	0.57988	2.02838
A <sub>2</sub>	1	0	0	0.42233	0.37641	0.64928	2.44801
A <sub>3</sub>	1	1	0	0.40534	0.59845	0.88297	3.88677
A <sub>4</sub>	1	1	1	0	1	1	5
A <sub>5</sub>	1	0.753959	1	0.627155	0	1	4.38111
A <sub>6</sub>	1	1	1	0.529466	0.365451	0	3.89492
Sum	5	4.169663	3.239476	2.404841	2.713088	4.112127	0.72131

**Table 6: The Net Superior & Net Inferior and their Ranks**

	Net Superior Value(NS)	Net Inferior Value(NI)	NS-NI	Rank
A <sub>1</sub>	0.20714	-2.9716	3.17876	1
A <sub>2</sub>	0.19048	-1.7216	1.91213	2
A <sub>3</sub>	-0.5913	1.48192	-2.0732	5
A <sub>4</sub>	-0.2627	2.59516	-2.8579	6
A <sub>5</sub>	0.44841	1.66803	-1.2196	4
A <sub>6</sub>	0.00794	-0.2172	0.22515	3

**Table 7: Comparison Results**

Alternatives	Modify Neutrosophic ELECTRE	Ranking method of SVNSSs	Net Value	Rank
	Net Value	Rank		
A <sub>1</sub>	-0.016	3	0.678	2
A <sub>2</sub>	0.856	1	0.743	1
A <sub>3</sub>	0.2	2	0.647	3
A <sub>4</sub>	-3.04	4	0.639	4





## Role of Detection Probes in Real-Time Quantitative Polymerase Chain Reaction

Murugan Mukilan<sup>1\*</sup>, Vivekanandan Mallikarjun<sup>2</sup>, Siva Yaswanth<sup>2</sup>, Mepully Thomas Antony Mathew<sup>2</sup> and Muanandan Kavitha Sunithaa<sup>2</sup>

<sup>1</sup>Assistant Professor, Department of Biotechnology, Sri Ramakrishna College of Arts & Science, (Affiliated to Bharathiar University) Coimbatore, Tamil Nadu, India.

<sup>2</sup>P.G.Student, Department of Biotechnology, Sri Ramakrishna College of Arts & Science, (Affiliated to Bharathiar University) Coimbatore, Tamil Nadu, India.

Received: 20 Jan 2024

Revised: 09 Feb 2024

Accepted: 29 Apr 2024

### \*Address for Correspondence

#### Murugan Mukilan

Assistant Professor,  
Department of Biotechnology,  
Sri Ramakrishna College of Arts & Science,  
(Affiliated to Bharathiar University)  
Coimbatore, Tamil Nadu, India.  
Email: mukilan@srcas.ac.in



This is an Open Access Journal / article distributed under the terms of the **Creative Commons Attribution License** (CC BY-NC-ND 3.0) which permits unrestricted use, distribution, and reproduction in any medium, provided the original work is properly cited. All rights reserved.

### ABSTRACT

Real-Time Quantitative Polymerase Chain Reaction (RQ-PCR) is becoming an important and reliable tool for the identification, detection, and quantification of pathogenic presence in a unknown clinical sample. Majorly used in the detection of expression profiles of certain selected genes. Discovery of polymerase chain reaction (PCR) technology in the year 1984 by Kary Mullis results in the amplification of genetic material/deoxyribo nucleic acid (DNA) in an *invitro* condition with a varying temperature range. Basic principle of PCR technique relies on the enzymatic replication of template genomic material with the help of three different cyclic conditions includes denaturation, annealing, and extension. During the process of denaturation, double stranded DNA was converted into single stranded DNA (ssDNA) by the breakage of hydrogen bonds at a temperature of 94° C for 30 to 120 seconds. Formed ssDNA is act as a template for binding of primers at their 3' and 5' ends. Formed complex (ssDNA with bound primers) may act as initial starting point for DNA synthesis in *invitro* condition with the help of deoxynucleoside triphosphates (dNTPs), and Taq DNA polymerase (TDP) at a temperature of 54-60° C for a period of 30-40 seconds. Followed by annealing, elongation process was takes place at 72-80° C for 30-60 seconds for the elongation of DNA in the 5' to 3' direction with the help of dNTPs and TDP. In optimum conditions, TDP adds about 1000-1200 bp/minute during this process. At the end of elongation process double-stranded hybrid DNA molecule is formed with one existing parent strand and one newly formed daughter strand. These three steps are repeated for 20-35 times to obtain expected number of DNA

74531





**Murugan Mukilan et al.,**

sequence. Further, formed DNA molecules/its expression pattern were analyzed with the help of agarose gel electrophoresis (AGE). Thus, conventional PCR provides end-point analysis (EPA) for the *In vitro* synthesised DNA sequence. Drawbacks and time consuming process of EPA analysis will result in the development of RQ-PCR for the detection of individual cyclic reactions with the help of specific detection probes. These detection probes emit fluorescence signal during each cycle to identify and quantify the presence of pathogens/genome sequences present in the sample. In this review, we have discussed about the basic principle, detection mechanism and detection probes used in RQ-PCR in an elaborate manner. Presented review will also highlight the importance of detection probes in the detection process of RQ-PCR in diagnostic field.

**Keywords:** Real-Time Quantitative Polymerase Chain Reaction (RQ-PCR), Detection Probes – SYBR Green, TaqMan Probe, Dual hybridization probe, Molecular Beacon, Scorpion probe

## INTRODUCTION

Polymerase Chain Reaction (PCR) is one of the most powerful tool for the identification of minute amount of genetic materials (nucleic acids) present in a sample. It has delicate sensitive reactions due to its exponential amplification of the template sequence. Development of PCR technology results in the advanced detection of viral nucleic acids in the diagnostic field. In conventional days, end point detection/analysis was done using the agarose gel electrophoresis (AGE) while performing the normal PCR reactions. Now a day, Real-time Quantitative PCR (RQ-PCR) provides a wonderful platform for the identification of amplification in each cycle of PCR reaction. It reduced time, consumption of chemicals, and workforce in the field of genomic analysis. Establishment of this PCR detection method provided a basis for reliable and rapid detection/diagnosis of viral nucleic acids in a diseased state in the diagnostic setting. It is also used for monitoring viral load and its proliferation with reference to disease progression and clinical outcome (Whalley et al. 2001; Humar et al. 2002; Snijders et al. 2003; Watzinger et al. 2004, 2006; Trindade et al. 2020; Artika et al. 2022; Ghorbani et al. 2022; Wilhelm et al. 2022). Recently, RQ-PCR played a major role in the identification of viral presence during COVID-19 infection in a cost effective manner compared to other identification methods (Trindade et al. 2020; Artika et al. 2022; Ghorbani et al. 2022; Wilhelm et al. 2022). In this review, basic principle, various detection methods opted in RQ-PCR were discussed in an elaborate manner with the help of suitable pictorial representation in a concise manner.

## REAL TIME QUANTITATIVE POLYMERASE CHAIN REACTION PRINCIPLE

Real-time quantitative polymerase chain reaction (RQ-PCR) is also known as quantitative PCR. RQ-PCR is an enzymatic process used for the amplification of a template DNA region through the sequential steps of conventional PCR (i.e. Denaturation, Annealing, and extension) with real-time monitoring of the PCR progress. Like conventional PCR, it uses four important ingredients includes template DNA, thermostable DNA polymerase, primers (forward and reverse), nucleotides (dNTPs), and additionally use one fluoro-chrome molecule for the real-time monitoring of each cycle. This RQ-PCR provides a comparison between the number of starting template and amount of amplicon accumulated in an individual PCR cycle. Due to this in evident property, RQ-PCR is used in the precise mRNA quantification, gene expression studies, and determination of viral loads in a clinical sample (Arya et al. 2005; Riswari et al. 2016; Rocha et al. 2016; Artika et al. 2020). It did not show any cross-contamination due to the absence of post-PCR processes. Thus RQ-PCR has reframed the detection and quantification of viral particles/target nucleic acids in a diagnostic sample (Deepak et al. 2007; Riswari et al. 2016; Artika et al. 2022; Ghorbani et al. 2022; Wilhelm et al. 2022).



**Murugan Mukilan et al.,**

## QUANTIFICATION

In RQ-PCR, quantity of amplicons generated at the end of reaction was dependent on the number of template DNA molecules available in the initial reaction mixture (IRM). Less number amplicons were synthesized with the few number of DNA molecules with the IRM. It is vice-versa in large quantities. Thus number of DNA molecules generated from a sample was measured in a real-time manner. In this RQ-PCR, results were shown in the form of graphical representation which is having PCR cycle number in x-axis, and number of amplicons produced in y-axis. Representative graph [RG] (Fig. 1) was showing single amplification plot of RQ-PCR. The representative graph showed three different phases of RQ-PCR i.e. linear, exponential, and plateau phases. In linear phase (initial cycle), fluorescence emission of the amplicons was less compared to the base line. During exponential (E) phase, emission of fluorescence signal was high due to the doubling of product after completion of each cycle and show maximum duplication in this time. Fluorescence intensity in the E phase is used for data calculation. In third phase (plateau phase), there is no proper emission of fluorescence from the probes which will give misleading information.

Compared to initial and plateau phase, fluorescence emission of E phase was taken for calculating the amount of duplicated DNA at the end of RQ-PCR reaction (Arya et al. 2005; Wong et al. 2005; Kubista et al. 2006; Riswari et al. 2016; Artika et al. 2022; Ghorbani et al. 2022; Wilhelm et al. 2022). In all these three phases, fluorescence emission/excitation was achieved with the help of probes. RQ-PCR uses fluorescent reporter of probes for the detection and quantification of nucleic acids. They are broadly classified into two major categories based on their binding activity and its detection mechanism. First class of probe is intercalating with the double-stranded DNA molecules and detects both specific and non-specific amplicons (ex. SYBR Green I, and EvaGreen). Second class of probe is linked to specific oligonucleotide and detects specific amplicons only. It also includes hydrolysis probes (TaqMan probe), molecular beacons, dual hybridization probes, and scorpion probes. Other than these two classes, some nucleic acid analogs are also used in RQ-PCR. In all these classes, probe contains a fluorophore which is a fluorescent molecule absorbs light energy at a particular wavelength and reemits longer wavelength light. Two different types of fluorophore are used in the quantification they are donor/reporter and acceptor/quencher. When the donor absorbs light energy, its energy level raises to excited state. After excitation, energy level returns to ground level by emission of energy in the form of fluorescence. This emitted energy further transmitted to adjacent acceptor fluorophore present in its proximity. This exchange of energy from reporter to a quencher is termed as fluorescence-resonance-energy transfer (FRET). Based on the energy transfer, this FRET is also classified into two distinct FRET mechanisms i.e. FRET-quenching, and FRET. During FRET-quenching energy of a non-fluorescent molecule is released as heat. But FRET shows transmission of energy in the form of fluorescent light (Navarro et al. 2015; Artika et al. 2022).

## DETECTION PROBES

### SYBR Green

SYBR green was most commonly used as double-stranded DNA (dsDNA) intercalating agent. This most commonly used dye attaches to the minor groove of dsDNA and emit the fluorescence signal. Strength of fluorescence signal is depending on the existing quantity of dsDNA present in the reaction. This SYBR Green is also used in the detection of SARS-CoV-2 virus in a RQ-PCR reaction. This intercalating dye also existing with their own advantages and disadvantages in a RQ-PCR reaction. Advantages include its low cost, sensitivity, and convenience. Disadvantages of this probe include non-specific binding and binding with primer dimers (Arya et al. 2005; Tajadini et al. 2014) (Fig. 2).

### TaqMan Probe

TaqMan probe is one of the most commonly used hydrolysis probe which is designed to bind with the specific target sequence. Their activity depends on the 5'-3' exonuclease activity of Taq polymerase and hydrolyzes the attached probe in the entire RQ-PCR amplification. This TaqMan probe has two different dye molecules i.e. a fluorescent reporter (FR), and a quencher dye (QD). FR dye attached to 5' end, and QD linked in the 3'terminus. In intact



**Murugan Mukilan et al.,**

condition, the FR and QD stays in close proximity, shows quenched excitation energy which inhibit the emission of fluorescence. During RQ-PCR reaction, TaqMan probe binds with target sequence in its downstream region and emit signals through the cleavage of probe by the 5' exonuclease activity of the polymerase. This process place FR dye and QD as apart and emit excitation energy in the form of fluorescent signal. Intensity of fluorescence signal denotes the cleavage rate of probe in each cycle with respect to amplification of specific target sequence. Due to their specificity, this type of probe is most commonly used for detection of novel swine coronaviruses (Navarro et al. 2015; Pan et al. 2020; Suchaya 2020) (Fig. 3).

**Dual hybridization probe**

Dual hybridization probe consists of two hybridization probes. One probe carries a fluorophore at its 3' terminus, and another one has an acceptor fluorophore in its 5' terminus. Both the probes hybridize with their target sequence during the process of annealing to form a head to tail structure. Formation of this structure results in the mediation energy transfer process. In these two dyes, donor dye absorbs light, and other one release energy in the form of fluorescence at a higher wavelength. Fluorescence from the acceptor probe happens only during the attachment of both the probes with the target sequence during the process of annealing in RQ-PCR. Binding of both the probes, results in the emission of fluorescence signal which is directly proportional to amount of amplicons formed during the RQ-PCR process. Dual hybridization probes were used in the identification of *Bacillus anthracis* from the environmental samples (Arya et al. 2005; Bassy et al. 2018) (Fig. 4).

**Molecular Beacon**

Molecular beacon (MB) was also a hybridization probe, contains attached fluorescent and quenching dyes at the either end of a single-stranded DNA molecule. This MB forms a stem-loop structure in a free solution to bring fluorescent dye and the quenching dye in a close proximity. As a result, there is a quenching of resonance energy. Loop segment of the molecule is complementary to the target nucleic acid molecule, and stem is formed by annealing of complementary arm sequence with the probe terminus sequence. During the process of annealing, conformational change results in the separation of fluorophore from the quencher dye results in the release of resonance energy. This type of probe is also used in the detection of SARS-CoV-2 (Wang et al. 2013; Chrysostomou et al. 2021) (Fig. 5).

**Scorpion probe**

Scorpion probe (SP) is another type of fluorescence based method developed for the specific detection of PCR products. SP also uses stem and loop configuration due to the presence of complementary sequences on the 5' and 3' ends of the probe. SP has fluorophore reporter at the 5' end and quencher molecule at the 3' end. Specific probe sequence (PCR stopper) linked to 5' end of a primer sequence with a non amplifiable monomer. This PCR stopper may prevent the amplification of stem-loop sequence of SP. During annealing phase, SP tail probe sequence hybridizes with the complementary target sequence and extends to produce amplicons. As a result of intramolecular interaction results in the production of stronger signal compared to TaqMan or molecular beacon techniques (Arya et al. 2005; Singh et al. 2009) (Fig. 6).

**CONCLUSION**

RQ-PCR is a modification of conventional PCR technology; enable the real-time monitoring of PCR progress happens during each cycle. This technology, reduced the use of post-PCR analysis for the identification of amplification happened during a PCR cyclic conditions. RQ-PCR are dependent on a fluorescent reporter probe for the detection and quantification of amplicons produced during a PCR cyclic reaction. It is one of the powerful technique which is used for quantitative and qualitative analysis of amplification with the help of specific sensitivity and specificity. During COVID-19 pandemic, RQ-PCR is used as a golden standard for the identification and confirmation of SARS-CoV-2 pandemic. Other than diagnostic industries, this method is also used in the analysis of biological samples in research laboratories also. Future studies will be needed for the development of low-cost, portable, and user-friendly RQ-PCR instruments for the application in remote sensing and resource-limiting settings. This chapter described





**Murugan Mukilan et al.,**

about the principles, reagents/probes used in the RQ-PCR reactions for the real time analysis & identification of amplicons produced during each cycle within a RQ-PCR reaction. Latest technology of droplet-digital PCR (ddPCR) system uses microfluidic mechanism for the identification of expression of multiple genes within a single reaction. This ddPCR was one of a important advancement of RQ-PCR in terms of multiplexing.

## ACKNOWLEDGMENTS

Authors thank Department of Science and Technology, Government of India (DST-FIST PG College Level – A Program (SR/FST/COLLEGE-/2022/1203) for the establishment of DST-FIST Facility for Genomics and Proteomics in the Department of Biotechnology, Sri Ramakrishna College of Arts & Science (Autonomous), Coimbatore, Tamil Nadu, India.

### Conflicts of Interest

The author declare no conflict of interest

## REFERENCES

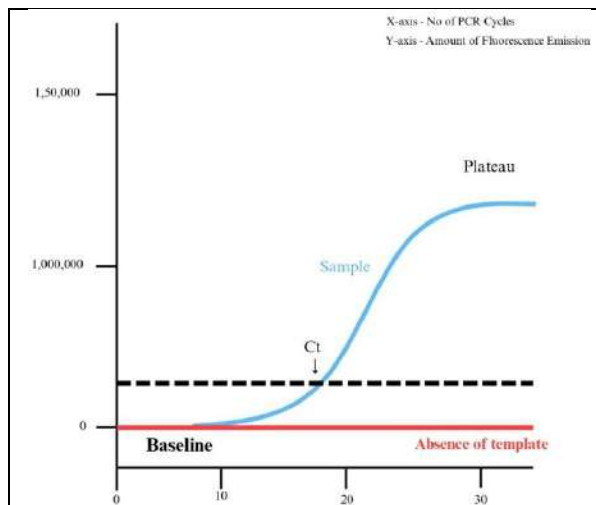
1. Artika, I.M., Wiyatno, A., & Ma'roef, C.N. (2020). Pathogenic viruses: Molecular detection and characterization. *Infection, Genetics, and Evolution*, 81, 104215.
2. Artika, IM, Dewi, Y.P., Nainggolan, I.M., Siregar, J.E., & Antonjaya, U. (2022). Real-Time Polymerase Chain Reaction: Current Techniques, Applications, and Role in COVID-19 Diagnosis. *Genes*, 13, 2387.
3. Arya, M., Shergill, I.S., Williamson, M., Gommersall, L., et al. (2005). Basic principles of real-time quantitative PCR. *Expert Review of Molecular Diagnostics*, 5, 209-19.
4. Bassy, O., Jiménez-Mateo, O., Ortega, M.V., Granja, C., & Cabria, J.C. (2018). Rapid identification of *Bacillus anthracis* by real-time PCR with dual hybridization probes in environmental swabs. *Molecular and Cellular Probes*, 37, 22-27.
5. Chrysostomou, A.C., Rodosthenous, J.H., Topcu, C., Papa, C., et al. (2021). A multiallelic molecular beacon-based real-time RT-PCR assay for the detection of SARS-CoV-2. *Life*, 11, 1146.
6. Deepak, S.A., Kottapalli, K.R., Rakwal, R., Oros, G., et al. Real-time PCR: Revolutionizing detection and expression analysis of genes. *Current Genomics*, 8, 234-251.
7. Ghorbani, M., Shokri, R., Kia, V., Yari, F., et al. (2022). New design and optimization of an in-house quantitative TaqMan Real-Time PCR-based assay for the detection and monitoring of occult hepatitis B virus (genotype A-J) infection. *Indian Journal of Medical Microbiology*, 40, 560-566.
8. Humar, A., Kumar, D., Boivin, G., & Caliendo, A.M. (2002). Cytomegalovirus (CMV) virus load kinetics to predict recurrent disease in solid-organ transplant patients with CMV disease. *The Journal of Infectious Diseases*, 186, 829-33.
9. Kubista, M., Andrade, J.M., Bengtsson, M., Forootan, A., et al. (2006). The real-time polymerase chain reaction. *Molecular Aspects of Medicine*, 27,95-125.
10. Navarro, E., Serrano-Heras, G., Castañõ, M.J., & Solera, J. (2015). Real-time PCR detection chemistry. *Clinica Chimica Acta*, 439, 231-250.
11. Pan, Z., Lu, J., Wang, N., He, W.T., Zhang, L., et al. (2020). Development of a TaqMan-Probe-based multiplex real-time PCR for the simultaneous detection of emerging and reemerging swine coronaviruses. *Virulence*, 11, 707-718.
12. Riswari, S.F., Ma'roef, C.N., Djauhari, H., Kosasih, H., et al. Study of viremic profile in febrile specimens of chikungunya in Bandung, Indonesia. *Journal of Clinical Virology*, 74, 61-65.
13. Rocha, A.J., Miranda, R.d.S., Sousa, A.J.S., & da Silva, A.L.C. (2016) Guidelines for successful quantitative gene expression in real-time qPCR assays. In *Polymerase Chain Reaction for Biomedical Applications*; In Tech: London, UK.



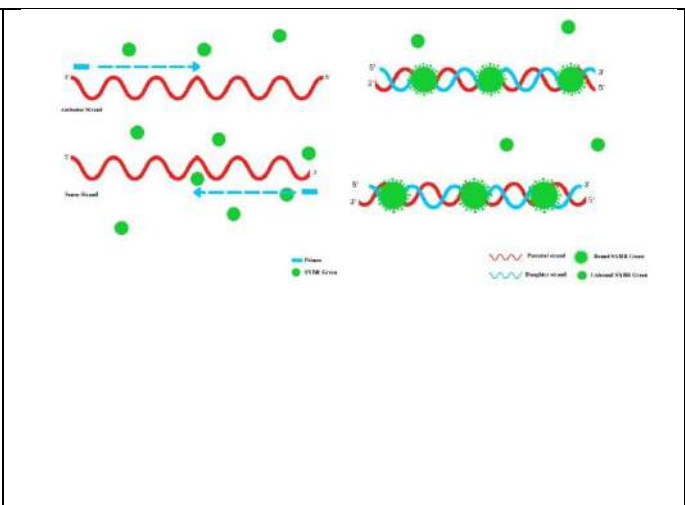


**Murugan Mukilan et al.,**

14. Singh, J., Batish, V.K., & Grover, S.A. (2009). A scorpion probe-based real-time PCR assay for detection of *E. coli* O157:H7 in dairy products. *Foodborne Pathog Di* 6, 395-400.
15. Snijders, P.J., van den Brule, A.J., & Meijer, C.J. (2003). The clinical relevance of human papillomavirus testing: relationship between analytical and clinical sensitivity. *The Journal of Pathology*, 201, 1-6.
16. Sucharya, P.K. (2020). Barriers to COVID-19 RT-PCR testing in Indonesia: A healthy policy perspective. *Journal of Indonesian Health Policy and Administration*, 5, 36-42.
17. Tajadini, M., Panjehpour, M., Javanmard, S.H. (2014). Comparison of SYBR Green and TaqMan Methods in quantitative real-time polymerase chain reaction analysis of four adenosine receptor subtypes. *Advanced Biomedical Research*, 3, 1-6.
18. Trindade, G.F., de Lima, S.M.B., Britto, C., & Fernandes-Monteiro, A.G. (2020). Detection of Yellow Fever Virus by Quantitative Real-Time PCR (qPCR) Methods in *Molecular Biology*, 2065,65-77.
19. Wagner, H.J., Cheng, Y.C., Huls, M.H., Gee, A.P., et al. (2004). Prompt versus preemptive intervention for EBV lymphoproliferative disease. *Blood*, 103, 3979-3981.
20. Wang, C., & Yang, C.J. (2013). Application of molecular beacons in real-time PCR. In *Molecular Beacons*; Yang, C.J., Tan, W., Eds; Springer: Berlin/Heidelberg, Germany, 2013.
21. Watzinger, F., Ebner, K., & Lion, T. (2006). Detection and monitoring of virus infections by real-time PCR. *Molecular Aspects of Medicine*, 27, 254-298.
22. Whalley, S.A., Murray, J.M., Brown, D., Webster, G.J., et al. (2001). Kinetics of acute hepatitis B virus infection in humans. *The Journal of Experimental Medicine*, 193, 847-54.
23. Wilhelm, A., Pallas, C., Marschalek, R., & Widera, M. (2022). Detection and Quantification of SARS-CoV-2 by Real-time RT-PCR Assay. *Methods in Molecular Biology*, 2452, 75-98.
24. Wong, M.L., & Medrano, J.F. (2005). Real-time PCR for mRNA quantification. *Biotechniques*, 39, 75-85.



**Figure 1.** Graphical representation of a single amplification curve in a real-time quantitative polymerase chain reaction (RQ-PCR) (Adapted from Arya et al. 2005)

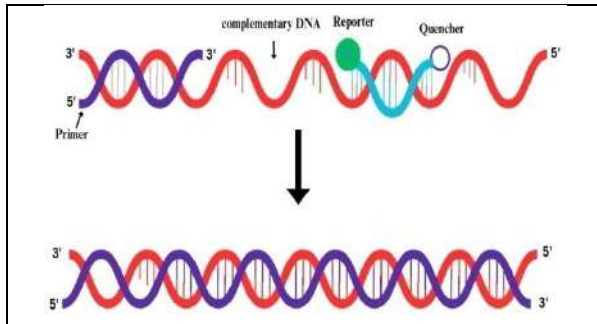


**Figure 2.** Graphical abstract showing the action mechanism of SYBR Green dye in a real-time quantitative polymerase chain reaction (RQ-PCR) (Adapted from Arya et al. 2005)

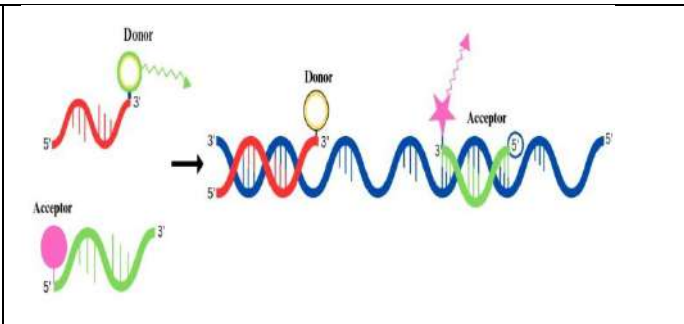




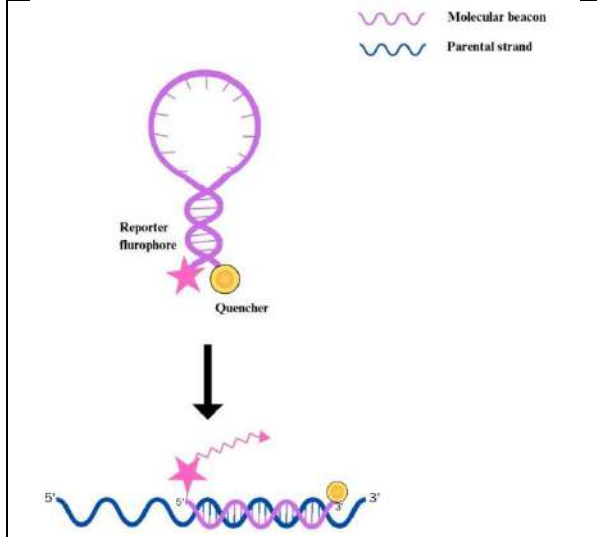
**Murugan Mukilan et al.,**



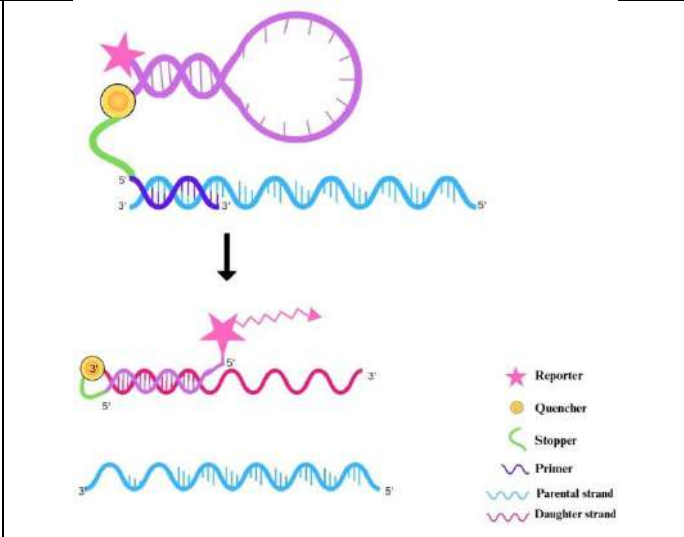
**Figure 3.** Pictorial representation showing the mode of action of TaqMan probe in a real-time quantitative polymerase chain reaction (RQ-PCR) (Adapted from Arya et al. 2005)



**Figure 4.** Working mechanism of dual hybridization probe in a real-time quantitative polymerase chain reaction (RQ-PCR) (Adapted from Arya et al. 2005)



**Figure 5.** Action mechanism of molecular beacon in a real-time quantitative polymerase chain reaction (RQ-PCR) (Adapted from Arya et al. 2005)



**Figure 6.** Graphical abstract showing the action mechanism of scorpion probe in a real-time quantitative polymerase chain reaction (RQ-PCR) (Adapted from Arya et al. 2005)





## Deep Insights into Lung Cancer: Automated Cytological Classification for Enhanced Diagnostic Precision and Effectiveness

Seema Kashyap<sup>1\*</sup> Arvind Kumar Shukla<sup>2</sup> and Iram Naim<sup>3</sup>

<sup>1</sup>Research Scholar, School of Computer Science and Engineering, IFTM University, Moradabad, Uttar Pradesh, India.

<sup>2</sup>Associate Professor, School of Computer Science and Engineering, IFTM University, Moradabad, Uttar Pradesh, India.

<sup>3</sup>Assistant Professor, Faculty of Engineering and Technology, MJP Rohilkhand University, Bareilly, Uttar Pradesh, India.

Received: 22 Jan 2024

Revised: 09 Feb 2024

Accepted: 27 Apr 2024

### \*Address for Correspondence

**Seema Kashyap**

Research Scholar,

School of Computer Science and Engineering,

IFTM University,

Moradabad, Uttar Pradesh, India.

Email: seemakashyap2484@gmail.com



This is an Open Access Journal / article distributed under the terms of the **Creative Commons Attribution License** (CC BY-NC-ND 3.0) which permits unrestricted use, distribution, and reproduction in any medium, provided the original work is properly cited. All rights reserved.

### ABSTRACT

Lung cancer is a dangerous disease that can be fatal, and a correct diagnosis is essential for figuring out the best way to treat it. The optimum treatment for people with lung cancer requires the classification of the disease into its histological types, such as adenocarcinoma (ADC), small cell lung cancer (SCLC), and squamous cell carcinoma (SCC). Each histological subtype has its features and may react differently to different types of medicine. So, knowing the exact subtype helps guide treatment choices and improve the patient's outcome. Lung cancer subtypes are necessary for personalized treatment. It helps doctors choose tumor-specific treatments such as surgery, radiation, chemotherapy, targeted drugs, and immune therapies. Precise categorization improves prognosis, avoids needless medicines, and lets patients participate in clinical studies targeting their cancer subtype. Precision medicine improves lung cancer outcomes with accurate categorization. The current algorithms in this domain have shown deficiencies in performance criteria like as specificity, F-score, sensitivity, and precision in recognition. These limitations may stem from challenges such as the complexity and heterogeneity of histopathological images, variations in staining techniques, and the presence of confounding factors. Deep learning methods have made it easier to look at histopathology slides of cancer and see what's going on. Several studies have shown that convolutional neural networks (CNN) are essential for classifying histopathological pictures of different kinds of cancer, like brain, skin, breast, lung, and colon cancer. This study divides lung cancer images into three groups: normal, adenocarcinoma, and squamous cell carcinoma. We have been





Seema Kashyap *et al.*,

training deep learning algorithms to identify lung cancer in histopathology slides better, and utilizing deep learning strategies and cutting-edge algorithms such as VGG-19, ResNet-50 v2, EfficientNetB1, and others indicate a comprehensive approach to addressing the problem. Deep learning models, notably CNNs and pre-trained models, possess exceptional performance in computer vision tasks including detecting instances, semantic separation, recognising objects, and image classification. These models are accurate and effective in pixel-level object segmentation, picture classification, object detection, image synthesis, and image captioning. Non-small cell carcinomas such as ADC, SCC, and SCLC are particularly interesting in this study because of the potential for improved diagnostic accuracy and stability.

**Keywords:** Deep learning, lung cancer, classification, VGG-19, ResNet-50 v2, EfficientNetB1, and images from histopathology

## INTRODUCTION

Lung cancer is the leading killer of people of all ages, hence efforts must be made to increase survival rates by better understanding the nature of the illness. It's divided into SCLC and NSCLC. SCLC is aggressive and fast-growing, generally linked to smoking, whereas NSCLC is the most prevalent kind with slower development and various subtypes. Early identification and correct categorization are essential for personalised surgery, radiotherapy, chemotherapy, targeted treatments, and immune therapies. Awareness and prevention are crucial to fighting this fatal disease. Squamous cell carcinoma, adenocarcinoma and giant cell carcinoma are the subtypes that fall under the umbrella of non-small cell lung cancer (NSCLC). It might be difficult in clinical practice to distinguish between adenocarcinoma and squamous cell carcinoma solely based on physical features. For accurate distinction, immune histochemical assessment is frequently necessary. Compared Cytological examination of small cell carcinoma, or cyst diagnosis, provides advantages over histology specimens because it typically shows crushed tiny cancer cells. A proper diagnosis requires combining cytological evaluation and histological analysis. To correct a diagnosis, cytological assessment and histological diagnosis must be connected. However, the cell shape of these three subtypes of lung cancer cells can differ significantly. This work aims to create an automated method of lung cancer categorization utilizing cytological pictures. One of the four essential carcinomas previously stated that is somewhat easier to identify is extensive cell carcinoma due to its peculiar cell shape. Because subtypes of NSCLC can occasionally be confused for one another in cytological specimens, the study focuses primarily on discriminating between these cancer types. Using the application of automated cytological categorization methods. Its objective is to increase the accuracy and effectiveness of diagnosing lung cancer using images. This article is divided into five pieces. Section two gives the background knowledge and research-related papers on classification-based deep learning and chest disease diagnosis. The final section of the article goes into more detail about the approach we utilized and the deep learning architecture we suggested. The dataset, data preparation, results, comparisons with current state-of-the-art systems for identifying and classifying lung cancer, experimental setups, performance metrics for the proposed technique, and a summary of the findings are covered in the fourth section. Conclusions and suggestions for more study are offered in the fifth part.

### Background Study

#### Classification and analysis of Likert scale questions

Lung cancer can spread from the lungs. Based on cell type, it is divided into two primary types: NSCLC and SCLC. 85% of lung cancer cases are NSCLC, and 15% are SCLC. Adenocarcinoma, squamous, and big cell carcinoma are NSCLC subtypes based on cell features. Classification is crucial for patient therapy and prognosis. Analysis of different treatment options, such as surgery, radiation therapy, chemotherapy, targeted therapy, immunotherapy, and palliative care, depending on the type of lung cancer. Classifying and analysing lung cancer helps research.







Seema Kashyap et al.,

Researchers can better understand the patient experience and identify factors that can be targeted to improve quality of life. This section outlines research on prediction in lung images using pre-trained and ensemble models. The combination of CNN and VGG19, according to Alshmrani, beat prior research in terms of recall (93.75 percent), accuracy (96.48 percent), F1 score (95.62 percent), precision (97.56 percent), and area under the curve (99.82 percent). The proposed method outperformed competing models, allowing for more rapid and precise diagnosis and treatment of patients [1]. One of the most prominent signs of COVID-19 infection is pneumonia. As a result of transfer learning, we know that the same virus causes COVID-19 and pneumonia. The application of transfer learning demonstrated promising results in identifying lung illnesses, specifically COVID-19. Pre-trained models such as VGG-16, ResNet-50, and InceptionV3 have been utilized successfully by researchers to analyze clinical pictures of lung disorders like COVID-19 [2]. An ensemble of the InceptionResNet V3, ResNet50, and MobileNet V3 models performed classifications. The data showed that these models did better than the others, getting an F1 score of 94.84%. [3]. In another paper, COVID-19 was evaluated using InceptionV3, NASNet, Xception, DenseNet, MobileNet, VGGNet, InceptionResNetV2, and Res Net for the classification of a combined dataset of CXR and CT images. DenseNet121 achieved the highest accuracy, 99%, of all systems tested. [4]. The study included 180 X-rays from patients infected with COVID-19. They intended to deploy efficient systems, including the ResNet50V2 and Xception networks, to spot the infection. The proposed model's accuracy was 99.50% for instances of COVID-19 specifically, whereas it was 91.4% for all classes. [5]. Gao combined ResNet and depth-ResNet models for TB risk assessment and severity score prediction, improving accuracy to 92.70% (from 67.15% with a ResNet-50 model). According to the data, both approaches were approximately as accurate as stated: 75.88% and 85.29%, respectively [6]. AlexNet, GoogleNet, and ResNet are three common designs Hooda R proposed using in an ensemble approach. A new classifier for categorizing TB was created from scratch using a pooled dataset of openly available standard datasets. The suggested method outperformed most current methods with an accuracy of 88% and an AUC (Area Under the Curve) of 0.93%. [7]. To find COVID-19, the author created a 3D deep learning system called COVNet. The backbone architecture that COVNet uses is ResNet50. [8]

### Classification and analysis of opinions

In order to determine the different subtypes of NSCLC, a number of studies turned to a variety of different categorization and analysis methods. The three-class classification was carried out using the DRENet learning architecture. In all three classes, the DRENet model scored an average recall of 0.93 and a precision of 0.93. The combined precision and recall metric, the F1-score, was likewise reported to be 0.93. [9]. Using Deep CNN, Rahimzadeh created a framework. This innovative approach combined the power of the ResNet50V2 and XceptionNet models to predict pneumonia outcomes with remarkable efficiency. The researchers compared their results with those obtained from other models and achieved accuracy of 91.4% [10]. Building upon this progress, Ieracitano developed a CNN algorithm specifically designed for pneumonia identification. Although specific details about the algorithm are not mentioned, it can be inferred that their work contributed to the growing body of research focused on improving the accuracy and effectiveness of pneumonia diagnosis [11]. AHHMM (Adaptive Hierarchical Heuristic Mathematical Model) is a system for lung cancer detection that uses several steps, such as picture acquisition, preprocessing, binarization, thresholding, segmentation, feature extraction, and deep neural network detection (DNN). Achieved 96.67% accuracy in identifying lung cancer [28]. 3DDCNN (3D Deep Convolutional Neural Networks): Combines deep learning and cloud computing to identify lung nodules. Uses the Multi-Region Proposal Network (mRPN) architecture. Achieved 98.5% accuracy in identifying lung cancer [36]. DenseNet with AdaBoost: Utilizes picture preprocessing techniques, DenseNet architecture, and adaptive boosting (AdaBoost) for lung cancer classification. Achieved 89.85% accuracy in detecting lung cancer [34]. Investigating the performance of the VGG19-CNN, ResNet152V2, ResNet152V2 Plus GRU, and ResNet152V2 + Bi-GRU models using digitized chest X-ray and CT datasets. This metric is used to compare the performance of various deep-learning models. With superior accuracy, AUC, recall, precision, specificity, negative predictive value, F1 score, and Matthew's correlation coefficient, the VGG19 + CNN model outperforms its rivals [12]. Using the LUNA16 dataset, a model for categorising patients with lung cancer that makes use of 3D filters, a DenseNet-based architecture, and pooling kernels achieves a classification accuracy of 92.4%. [14]. MTMR-Net: Modeling lung nodules using a Siamese network design. demonstrated 93.5% accuracy in diagnosing lung cancer, which is higher than any competing approach [35]. Utilizes



**Seema Kashyap et al.,**

a 2D CNN and the Taguchi method to identify lung cancer automatically. increased classification accuracy was attained [32]. Mask R-CNN, volume rendering, and ray-casting techniques are applied for pulmonary nodule detection and segmentation. includes components for 3D modeling, detection, segmentation, and preprocessing. A sensitivity of 88.7 percent was achieved [33].

**Selection of classifier and opinion analysis technique**

Classifying lung cancer data should ideally begin with an evaluation model. It will do a great job of setting the scene and classifying things. To perform feature importance analysis, a learning model called Gradient Boosting Machine is trained on a dataset including the target variable (lung cancer subtype) and the relevant features (such as the patient's characteristics, test results, medical history, etc.). The method of deep learning consists of several processes, namely preprocessing, extraction of features, choice of features, optimisation, and classification. Preprocessing can enhance the clarity of distorted photos. The image undergoes pre-processing, followed by feature extraction to obtain its distinctive characteristics. The process of selecting the most crucial extracted features is at the subsequent stage. The ultimate determination is made by an independent classifier. Recent study has utilised deep learning techniques to successfully detect lung cancer, yielding promising outcomes. Cancer diagnosis technologies that rely on deep learning are complex and time-consuming due to their reliance on several classifiers and human feature identification to analyse vast quantities of data. These methods often result in low precision because to inadequate fitting of extremely large datasets. The accuracy of feature retrieval and the quality of their representation greatly influence the performance of deep learning models. Feature extraction can be enhanced by the utilisation of transfer learning and a well-designed architectural framework.

**METHODOLOGY**

The EfficientNetB1, ResNet50v2, and VGG19 models, which has been pretrained using the ImageNet dataset, is used in this study. The final output layer is swapped for linear and dropout layers to fine-tune the model. We only train the newer layers and leave the older ones unmoving. 80% of the data is allocated for the training phase, while the remaining 20% is used for evaluation. The efficacy of the model can be assessed by dividing this data into separate training and evaluation sets.

**Sequential methodology for the suggested task**

- Import the photos from the LC25000 dataset:
- Import the dataset, which involves reading the image files and their related labels.
- The user's text consists of a bullet point symbol. Create three sets: one for testing, one for validation, and one for training.

**From the dataset**

- Resize the images to 256\*256 for the EfficientNetB1, ResNet50v2, and VGG19 models.
- Normalize the pixel values of the images to a standard scale.

**Transfer learning and fine-tuning:**

- Load the pre-trained EfficientNetB1, ResNet50v2, and VGG19 models, excluding the classification layer(s).
- In the pre-trained model, we incorporate classification layers that correspond to the number of classes present in the dataset.
- We exclusively modify the higher levels of the model, while keeping the weights of the lower layers unaltered.
- After incorporating the model into the training set, its effectiveness on the validation set will dictate when the training process should be concluded.
- It is recommended to make use of the ADAM optimizer in conjunction with the categorical cross-entropy loss function when resolving problems that involve more than one class.





**Seema Kashyap et al.,**

### Train the model

- Specify the training hyperparameters, such as the 25 epochs, 482 batch size, and 0.0010 learning rate.
- Using the "sparse\_categorical\_crossentropy" loss and the "Adam" optimizer, create an executable version of the model.
- Train the model on the training set, monitoring the validation set's performance.
- Adjust the hyperparameters as needed based on the validation results.
- Evaluate the performance on the evaluation set by using the following criteria.

### Evaluation Criteria

To measure the effectiveness of the model, metrics like as recall (Rec), accuracy (Acc), precision (Pre), and the confusion matrix are employed.

#### Accuracy (ACC)

The degree to which a model's predictions are accurate is a measure of its accuracy.

$$Accuracy = \sum_c \frac{TP_c + TN_c}{TP_c + FP_c + TN_c + FN_c}, c \in classes$$

#### Precision (Pre)

The precision metric is a measure of how many out of all the photos that were identified as malignant lung actually were.

$$Precision = \sum_c \frac{TP_c}{TP_c + FP_c}, c \in classes$$

#### Recall (Rec)

The percentage of lung cancer photos that were correctly classified out of all the lung cancer images is called recall, which is also called sensitivity or the real positive rate.

$$Recall = \sum_c \frac{TP_c}{TP_c + FN_c}, c \in classes$$

#### F1-score

By merging recall and precision into a single statistic, the F1 score achieves a balance between the two. Accuracy and recall are balanced by it.

$$F1_{score} = 2 * \frac{precision * sensitivity}{precision + sensitivity}$$

The confusion matrix is a table that can be used to evaluate the performance of a classification model. The counts of predictions that were right, wrong, or inferred incorrectly are displayed..

TP: True Positive: Correctly identified images of a malignant lung

TN: True Negative: Imaging of a normal lung is reliably identified as such.

FP: False Positive: Non-malignant lung pictures are erroneously identified as malignant lung.

FN: False Negative: Instances where images of lungs with cancer are incorrectly classified as healthy lungs.

Through the computation of these metrics and examination of the confusion matrix, we can evaluate the efficacy of the constructed model in relation to its accuracy, precision in correctly categorising cancerous lung images, recall in detecting cancerous lung images, and the equilibrium between precision and recall as indicated by the F1-score.





Seema Kashyap *et al.*,

## ANALYSIS OF DATA AND IMPLICATIONS

### Compiling and Preparing Data

This study utilises a collection of histopathology photos hosted on Kaggle. The dataset consists of improved histology photos depicting lung and colon cancer. It contains a total of 25000 histopathology pictures, which are categorised into 5 groups. The dimensions of all the JPEG files are 768 pixels on the longest side. Once the dataset has been processed and relevant features have been retrieved using Convolutional Neural Network (CNN) techniques in Python, the model is then constructed and evaluated. The photos are evaluated and categorised using several convolutional neural networks (CNN) techniques. The collection has three categories of lung images and two categories of colon images, each containing 5,000 images: Noncancerous tissue of the lungs, A type of lung cancer called adenocarcinoma, Squamous cell carcinoma of the lung, Adenocarcinoma of the colon, Benign tissue of the colon

### Lung' benign tissue

- An unwanted, noncancerous abnormal growth of tissue
- is a benign lung tumor. Several lung structures can give rise to benign lung tumors.
- It is essential to distinguish between a benign tumor and a malignancy in its early stages.
- Benign tumors usually grow slowly and eventually stop growing.
- Benign tumors do not spread infections throughout the body.

### Lung' adenocarcinoma

- This is very common type of lung cancer.
- Those who smoking in present or have smoked in the past are more likely to develop this type of cancer. But it's also present in non-smokers who living with that people.
- Women are more likely than men to get lung adenocarcinoma. It also has a higher likelihood of affecting younger generations.
- Adenocarcinoma is often discovered before it has spread. and is typically found in the outer area of the lung.
- Lung adenocarcinoma is the primary cause of cancer deaths while having a lower mortality rate.

### Lung squamous cell cancer:

- Over time, cancer cells can spread via the bloodstream and invade nearby lymph nodes and organs, called metastasis.
  - Lung squamous cell cancer is highly associated with a person's smoking history.
  - Squamous cell carcinoma has been linked to a high rate.
- Exposure to second-hand smoking, a family history of lung cancer, and old age are risk factors for SCC.

### Implementation Decision Tree Classifier

Before applying a Decision Tree Classifier to the "LC25000" lung cancer dataset, the data must be loaded and pre-processed. Subsequently, the data must be divided into training and testing sets. Lastly, the Decision Tree Classifier must be trained and evaluated. These steps are necessary in order to successfully apply the Decision Tree Classifier. Data preprocessing and augmentation are necessary to train deep learning models. Data preprocessing cleans and transforms raw data, whereas data augmentation creates synthetic data by modifying existing data. Both steps increase model generalisation and performance.

### Implementation of Opinion Analysis

Using the already-trained EfficientNetB1, ResNet50v2, and VGG19 as a foundation, we develop a model for classifying data. Weights from ImageNet and untrainable layers make up the foundation. The model includes a final output layer with SoftMax activation for classification and two dense layers for feature extraction. The "Adam" optimizer, "sparse\_categorical\_crossentropy" loss (for integer labels), and accuracy metric are used during model compilation. Training can be optimized by using a model with a training method that includes early halting and learning rate drop callbacks. We plot training images with both the predicted and real class labels.





Seema Kashyap et al.,

## CONCLUSION AND DISCUSSION

The lung cancer diagnosis method employed three deep learning models, namely VGG19, ResNet50-v2, and efficientnetB1. The models underwent training and refinement using histopathology images. Accuracy of recognition, specificity, recall, F-Score, and precision were among the effectiveness metrics utilised to evaluate the method. EfficientnetB1 achieved superior performance compared to VGG19 (99.50%) and ResNet50-v2 (98.57%) with an accuracy rate of 99.90%. The outcome demonstrates that efficientnetB1 exhibited superior performance in distinguishing between malignant and benign lung pictures. The accuracy and recall rate of the system were both 99.90%. The EfficientnetB1 model achieves the best F-Score, which is a metric that evaluates the model's ability to balance precision and recall effectively. In contrast to the other models, efficientnetB1 achieved the highest test accuracy of 99.90% when a distinct neural network model was constructed utilising the pre-trained models. There were no misclassifications observed between photos that showed malignant and noncancerous conditions, which is noteworthy. However, there were errors in the classification of adenocarcinoma and squamous cell carcinoma, which are two types of lung cancer. Additional enhancements could be implemented to distinguish more effectively among these subcategories. Suggestions have been made to utilise fuzzy genetic optimisation techniques and deep learning methodologies to enhance the proposed methodology. There were no misclassifications of images between carcinogenic and noncancerous tissue. Nevertheless, the designations for the subcategories of lung cancer, namely squamous cell carcinoma and adenocarcinoma, were incorrect. There is still potential for advancement in the creation of accurate differentiation between subtypes. EfficientNetB1's pretrained architecture proved to be the most suitable for the task of lung cancer classification, as it outperformed all other models in terms of precision, recall, efficacy, and F-score. The model demonstrated strong performance in classifying the different subtypes of lung cancer, as indicated by the precision (accuracy in identifying positive cases), recall (ability to capture all positive instances), and F-score (a combined measure of precision and recall) metrics.

## REFERENCES

1. Alshmrani, G. M. M., Ni, Q., Jiang, R., Pervaiz, H., & Elshennawy, N. M. (2023). A deep learning architecture for multi-class lung disease classification using chest X-ray (CXR) images. *Alexandria Engineering Journal*, 64, 923–935.
2. Perumal, V., Narayanan, V., & Rajasekar, S. J. S. (2021). Detection of COVID-19 using CXR and CT images using Transfer Learning and Haralick features. *Applied Intelligence*, 51, 341-358.
3. El Asnaoui, K. (2021). Design an ensemble deep learning model for pneumonia disease classification. *International Journal of Multimedia Information Retrieval*, 10(1), 55–68.
4. Kassania, S. H., Kassanib, P. H., Wesolowski, M. J., Schneider, K. A., & Deters, R. (2021). Automatic detection of coronavirus disease (COVID-19) in X-ray and CT images: a machine learning approach. *Biocybernetics and Biomedical Engineering*, 41(3), 867-879.
5. Rahimzadeh et al. (2020). A modified deep convolutional neural network for detecting COVID-19 and pneumonia from chest X-ray images based on the concatenation of Xception and ResNet50V2. *Informatics in Medicine Unlocked*, 19, 100360.
6. Gao, X. W., James-Reynolds, C., & Currie, E. (2020). Analysis of tuberculosis severity levels from CT pulmonary images based on enhanced residual deep learning architecture. *Neurocomputing*, 392, 233-244.
7. Hooda, R., Mittal, A., & Sofat, S. (2019). Automated TB classification using an ensemble of deep architectures. *Multimedia Tools and Applications*, p. 78, 31515–31532.
8. o, T., Skornitzke, S., Merle, U., Kittel, M., Hofbaur, S., Melzig, C., Wielpütz, M., & Weinheimer, O. (2022). COVID-19 pneumonia: Prediction of patient outcome by CT-based quantitative lung parenchyma analysis combined with laboratory parameters. *PLoS One*, 17(7), e0271787.
9. Podder, P., Das, S. R., Mondal, M. R. H., Bharati, S., Maliha, A., Hasan, M. J., & Piltan, F. (2023). Lddnet: a deep learning framework for the diagnosis of infectious lung diseases. *Sensors*, 23(1), 480.





## Seema Kashyap et al.,

10. Ieracitano, C. et al. (2022). A fuzzy-enhanced deep learning approach for early detection of COVID-19 pneumonia from portable chest X-ray images. *Neurocomputing*, 481, 202-215.
11. Cherukuri, N., Bethapudi, N. R., Thotakura, V. S. K., Chitturi, P., Basha, C. Z., & Mummidi, R. M. (2021, March). Deep learning for lung cancer prediction using nscls patients' CT information. In the 2021 International Conference on Artificial Intelligence and Smart Systems (ICAIS) (pp. 325-330). IEEE.325–330
12. Zhang, G., Lin, L., & Wang, J. (2021, March). Lung nodule classification in CT images using 3D densenet. In *Journal of Physics: Conference Series* (Vol. 1827, No. 1, p. 012155). IOP Publishing.
13. V. Rajasekar, B. Predi'c, M. Saracevic, M. Elhoseny, D. Karabasevic, D. Stanujkic, P. Jayapaul, Enhanced multimodal biometric recognition approach for smart cities based on an optimized fuzzy genetic algorithm, *Sci. Rep.* 12 (1) (2022) 1–11.
14. Khan, A., Akram, M. U., & Nazir, S. (2023). Automated grading of chest x-ray images for viral pneumonia with convolutional neural networks ensemble and region of interest localization. *PLoS One*, 18(1), e0280352.
15. S. Krishnamoorthi, P. Jayapaul, V. Rajasekar, R.K. Dhanaraj, C. Iwendi, A futuristic approach to generate random bit sequence using the dynamic perturbed chaotic system, *Turk. J. Electr. Eng. Comput. Sci.* 30 (1) (2022) 35–49
16. Bijaya Kumar Hatuwal, H.C.T., (2021) Lung Cancer Detection Using Convolutional Neural Network on Histopathological images. [online] *Ijcttjournal.org*. Available at: <http://www.ijcttjournal.org/archives/ijctt-v68i10p104> [Accessed 19 Jun. 2021].
17. Borkowski, A.A., Bui, M.M., Thomas, L.B., Wilson, C.P., DeLand, LA and Mastorides, S.M., (2019) Lung and Colon Cancer Histopathological Image Dataset (LC25000). *arXiv [eess.IV]*. Available at: <http://arxiv.org/abs/1912.12142> [Accessed 17 Jun. 2021].
18. B. Ricciuti, G. Jones, M. Severgnini, J.V. Alessi, G. Recondo, M. Lawrence, M. Awad, Early plasma circulating tumor DNA (ctDNA) changes predict response to first-line pembrolizumab-based therapy in non-small cell lung cancer (NSCLC), *J. Immunother—cancer* 9 (3) (2021).
19. Y. Chen, E. Zitello, R. Guo, Y. Deng, The function of LncRNAs and their role in the prediction, diagnosis, and prognosis of lung cancer, *Clin. Transl. Med.* 11 (4) (2021) e367.
20. J. Hanaoka, M. Yoden, K. Hayashi, T. Shiratori, K. Okamoto, R. Kaku, A. Sonoda, Dynamic perfusion digital radiography for predicting pulmonary function after lung cancer resection, *World J. Surg. Oncol.* 19 (1) (2021) 1–10.
21. V. Rajasekar, J. Premalatha, K. Sathya, Cancelable Iris template for secure authentication based on random projection and double random phase encoding, *Peer-to-Peer Network. Appl.* 14 (2) (2021) 747–762.
22. M. Gaga, J. Chorostowska-Wynimko, I. Horv' ath, M.C. Tammemagi, D. Shitrit, V. H. Eisenberg, Q. Zhou, Validation of Lung EpiCheck, a novel methylation-based blood assay, for the detection of lung cancer in European and Chinese high-risk individuals, *Eur. Respir. J.* 57 (1) (2021)
23. H. Chao, H. Shan, F. Homayounieh, R. Singh, R.D. Khera, H. Guo, P. Yan, Deep learning predicts cardiovascular disease risks from lung cancer screening low dose computed tomography, *Nat. Commun.* 12 (1) (2021) 1–10
24. Zech JR, Badgeley MA, Liu M, Costa AB, Titano JJ, Oermann EK (2018) Variable generalization performance of a deep learning model to detect pneumonia in chest radiographs: a cross-sectional study. *PLoS medicine.* 15(11):e1002683.
25. Zhang, F. (2021) Application of machine learning in CT images and X-rays of COVID-19 pneumonia. *Medicine*, 100(36)
26. H. Shin, S. Oh, S. Hong, M. Kang, D. Kang, Y.G. Ji, Y. Choi, Early-stage lung cancer diagnosis by deep learning-based spectroscopic analysis of circulating exosomes, *ACS Nano* 14 (5) (2020) 5435–5444.
27. Y. She, Z. Jin, J. Wu, J. Deng, L. Zhang, H. Su, C. Chen, Development and validation of a deep learning model for non-small cell lung cancer survival, *JAMA Netw. Open* 3 (6) (2020) e205842, e205842.
28. Yu, H., Zhou, Z., & Wang, Q. (2020). Deep learning assisted predict of lung cancer on computed tomography images using the adaptive hierarchical heuristic mathematical model. *IEEE Access*, p. 8, 86400–86410.





**Seema Kashyap et al.,**

29. V. Rajasekar, S. Krishnamoorthi, M. Saračević, D. Pepic, M. Zajmovic, H. Zogic, Ensemble machine learning methods to predict the balancing of ayurvedic constituents in the human body: ensemble machine learning methods to predict, *Comput. Sci.* 23 (1) (2022), <https://doi.org/10.7494/csci.2022.23.1.4315>.
30. Cai, L., Long, T., Dai, Y., & Huang, Y. (2020). Mask R-CNN-based detection and segmentation for pulmonary nodule 3D visualization diagnosis. *Ieee Access*, 8, 44400-44409.
31. Lin, C. J., Jeng, S. Y., & Chen, M. K. (2020). Using 2D CNN with Taguchi parametric optimization for lung cancer recognition from CT images. *Applied Sciences*, 10(7), 2591.
32. Pang, S., Zhang, Y., Ding, M., Wang, X., & Xie, X. (2019). A deep model for lung cancer type identification by densely connected convolutional networks and adaptive boosting. *IEEE Access*, 8, 4799–4805.
33. Albarqouni, S. et al. (2016). Aggnet: deep learning from crowds for mitosis detection in breast cancer histology images. *IEEE Transactions on medical imaging*, 35(5), 1313-1321.
34. Nanavaty, Prema, Michael S. Alvarez, and W. Michael Alberts. "Lung cancer screening: advantages, controversies, and applications." *Cancer Control* 21.1 (2014): 9-14.
35. Bashiri, A., Ghazisaeedi, M., Safdari, R., Shahmoradi, L., & Ehtesham, H. (2017). Improving the prediction of survival in cancer patients by using machine learning techniques: Experience of gene expression data: A narrative review. *Iranian Journal of Public Health*, 46(2), 165–172
36. Liu, L., Dou, Q., Chen, H., Qin, J., & Heng, P. A. (2019). A multi-task deep model with ranking margin loss for lung nodule analysis. *IEEE Transactions on medical imaging*, 39(3), 718–728.
37. Manyau, P. M., Mabeka, M., Mudzviti, T., Kadzatsa, W., & Nyamhunga, A. (2021). Renal function impairment in cervical cancer patients treated with cisplatin-based chemoradiation: A review of medical records in a Zimbabwean outpatient department. *Plos one*, 16(2), e0245383.
38. Zhang, Q., & Kong, X. (2020). Design of automatic lung nodule detection system based on multi-scene deep learning framework.
39. Agarwal, N., Balasubramanian, V. N., & Jawahar, C. V. (2018). Improving multi-class classification by deep networks using DAGSVM and Triplet Loss. *Pattern Recognition Letters*, 112, 184–190.
40. Khan, A., Akram, M. U., & Nazir, S. (2023). Automated grading of chest x-ray images for viral pneumonia with convolutional neural networks ensemble and region of interest localization. *PLoS One*, 18(1), e0280352.
41. Agarwal, N., Balasubramanian, V. N., & Jawahar, C. V. (2018). Improving multi-class classification by deep networks using DAGSVM and Triplet Loss. *Pattern Recognition Letters*, 112, 184–190.
42. Wang, J., Kim, Y. J., & Liu, C. (2023). Deep Learning for Detection and Characterization of Cracking in Ultra-High-Performance Concrete. *ACI Structural Journal*, 120(3), 3-15.
43. Abdel-Zaher AM, Eldeib AM (2016) Breast cancer classification using deep belief networks. *Expert Syst Appl* 46:139–144.
44. G. Zhang, S. Jiang, Z. Yang, L. Gong, X. Ma, Z. Zhou, C. Bao, Q. Liu, Automatic nodule detection for lung cancer in CT images: a review, *Comput. Biol. Med.* 103 (2018) 287–300.J.

**Table 1:**

	<b>Predicted: Cancerous Lung</b>	<b>Predicted: Normal Lung</b>
Actual: Cancerous Lung	TP	FN
Normal: Cancerous Lung	FP	TN

**Table 2: The number of images for each category and their distribution between the training set (80%) and the test set (20%).**

Class	Train	Test	Total
Healthy	4000	1000	5000
Adenocarcinoma	4000	1000	5000
Squamous-cell carcinoma	4000	1000	5000
<b>TOTAL</b>	<b>12000</b>	<b>3000</b>	<b>15000</b>



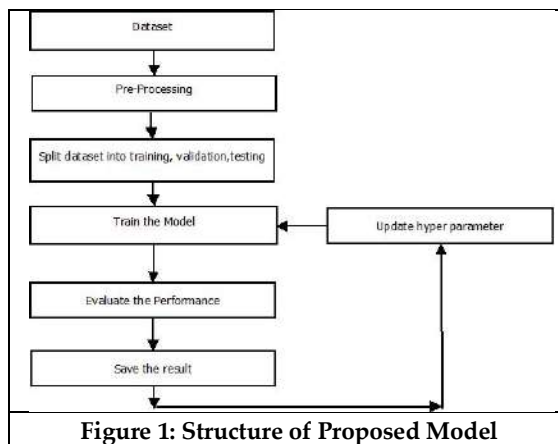
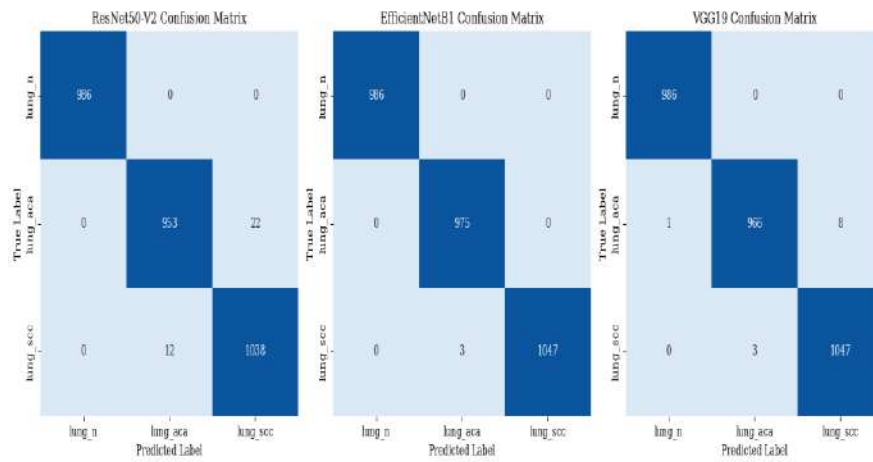


**Seema Kashyap et al.,**

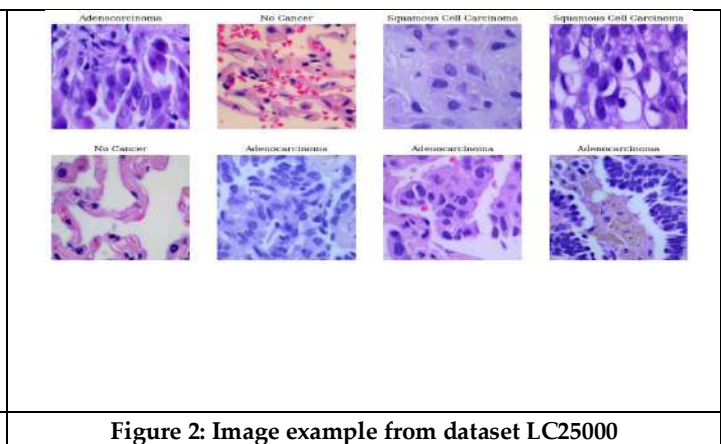
**Table 3: Metrics comparing three distinct CNN structures**

Model	Accuracy	Precision	Recall	F1-Score
ResNet50-V2	0.988708	0.988736	0.988708	0.988706
EfficientNetB1	0.999004	0.999007	0.999004	0.999004
VGG19	0.996015	0.996021	0.996015	0.996013

**Table 4: Confusion metrics for all three CNN architectures**



**Figure 1: Structure of Proposed Model**



**Figure 2: Image example from dataset LC25000**







Seema Kashyap et al.,

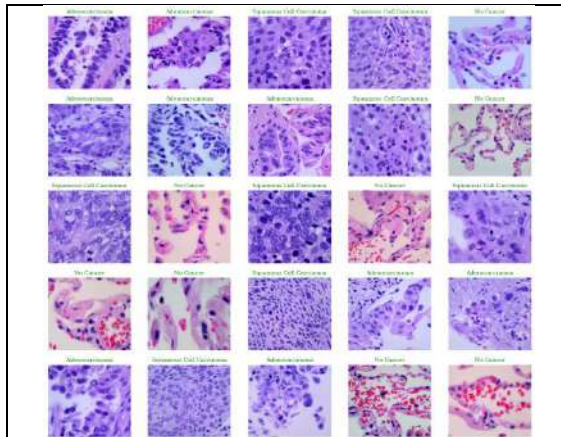


Figure 3: Plot prediction of ResNet50-V2

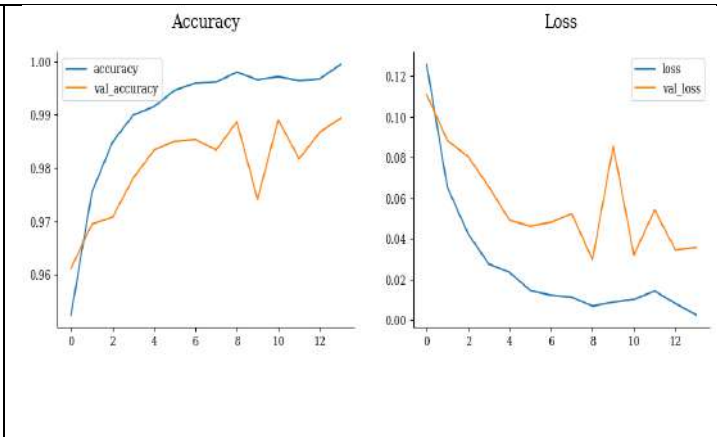


Figure 4: ResNet50-V2 Model Training and Validation: accuracy and loss

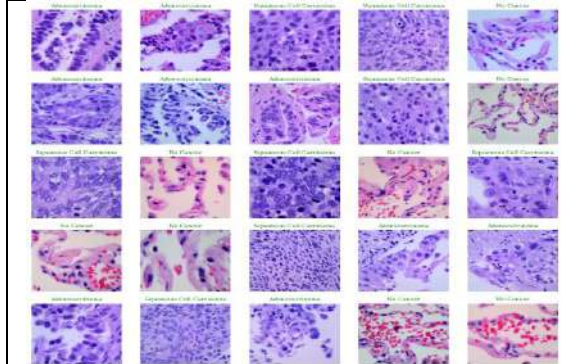


Figure 5: Plot prediction of the EfficientNetB1 model

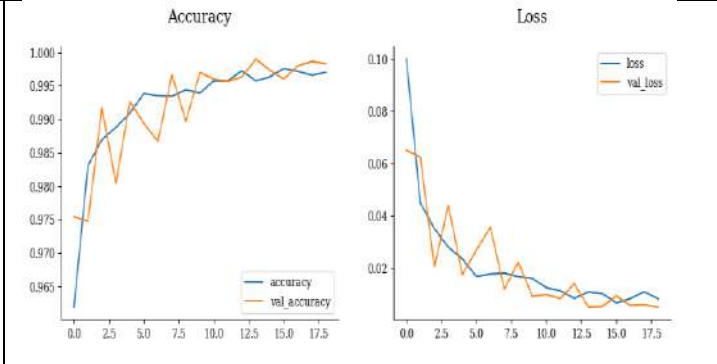


Figure 6: EfficientNetB1 Model Training and Validation: accuracy and loss

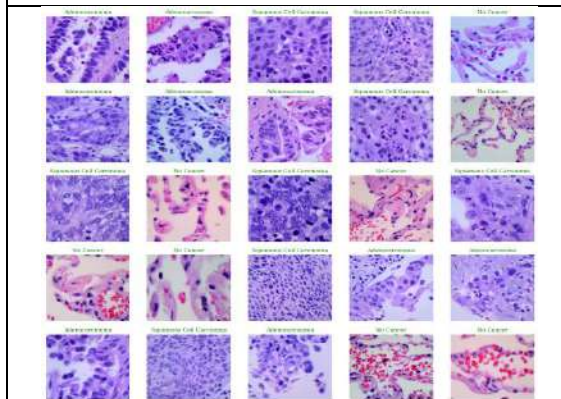


Figure 7: Plot prediction of VGG19 Model

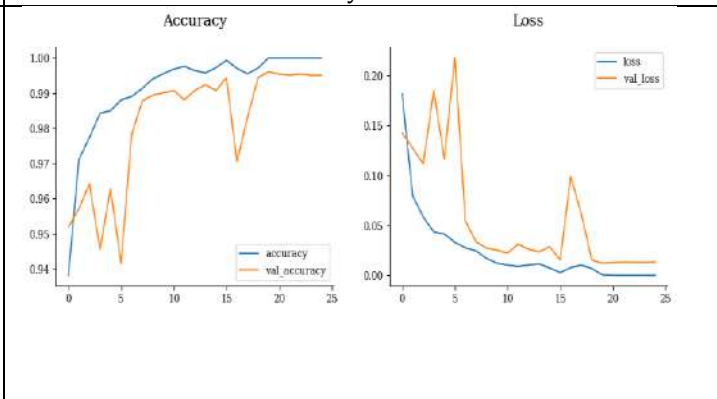


Figure 8: VGG19 Model Training and Validation: accuracy and loss





Seema Kashyap et al.,

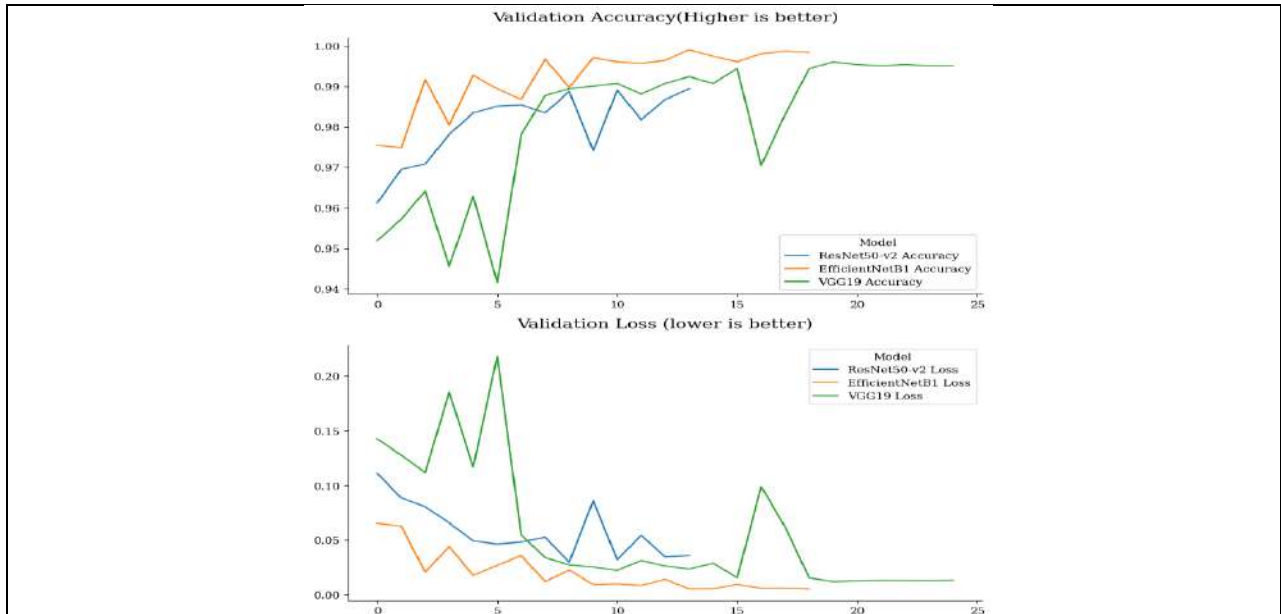


Figure 8: Comparison plot for ResNet50-V2, EfficientNetB1, VGG19Model Training and Validation: accuracy and loss





## Isolation, Characterization and Optimization of Biocement Production from Marine Microbes

Karthikeyan Vijayan<sup>1\*</sup>, Divya Srinivasan<sup>2</sup>, Venugopal Kaliyamoorthy<sup>3</sup> and Aravindhyan Sivakumar<sup>4</sup>

<sup>1</sup>Professor and Head, Department of Biotechnology, Karpaga Vinayaga College of Engineering and Technology, Chengalpattu, (Affiliated to Anna University, Chennai) Tamil Nadu, India.

<sup>2</sup>M.Tech, Department of Biotechnology, Karpaga Vinayaga College of Engineering and Technology, Chengalpattu, (Affiliated to Anna University, Chennai) Tamil Nadu, India.

<sup>3</sup>Research Scholar, Department of Biotechnology, Karpaga Vinayaga College of Engineering and Technology, Chengalpattu, (Affiliated to Anna University, Chennai) Tamil Nadu, India.

<sup>4</sup>B.Tech, Department of Biotechnology, Karpaga Vinayaga College of Engineering and Technology, Chengalpattu, (Affiliated to Anna University, Chennai) Tamil Nadu, India.

Received: 29 Dec 2023

Revised: 09 Feb 2024

Accepted: 03 May 2024

### \*Address for Correspondence

**Karthikeyan Vijayan**

Professor and Head,

Department of Biotechnology,

Karpaga Vinayaga College of Engineering and Technology, Chengalpattu,

(Affiliated to Anna University, Chennai)

Tamil Nadu, India.

Email: microkarthi2006@gmail.com



This is an Open Access Journal / article distributed under the terms of the **Creative Commons Attribution License** (CC BY-NC-ND 3.0) which permits unrestricted use, distribution, and reproduction in any medium, provided the original work is properly cited. All rights reserved.

### ABSTRACT

Bio-cement is a product innovation from developing bioprocess technology called bio-cementation. Bio-cement refers to  $\text{CaCO}_3$  deposit that formed due to microorganism activity in the system rich of calcium ion. The primary role of microorganism in carbonate precipitation is mainly due to their ability to create an alkaline environment through their various physiological activities. Bio-cement production from microbial induced calcium carbonate precipitation is an environmentally friendly approach for construction works. Over the last two decades, urea hydrolysis-based cementation has been intensively investigated for a number of MICP applications, including as concrete and crack repair, soil consolidation and stability and erosion management. The low viscosity and penetrability of the bio-cementation solution in soil, the cheap cost and energy consumption and the minimal or insignificant negative environmental effect are all major benefits of bio-cementation. Screening of bio-cement producing bacteria by calcium chloride precipitation and to characterize the bio-cement producing marine bacteria by using GCMS, SEM, EDX.

**Keywords:** Bio-cementation,  $\text{CaCO}_3$ , Marine microbes.





Karthikeyan Vijayan et al.,

## INTRODUCTION

Soil enhancement techniques can be categorized into ground reinforcement, ground improvement, and ground treatment. Recent advancements in ground improvement involve using bacteria for bio-mineralization, particularly the creation of calcium carbonate, a sustainable and eco-friendly process. Unlike chemically induced methods, this biological approach poses no environmental hazards. It includes "bio-clogging" and "bio-cementation" through microbial metabolism. While research in this field is ongoing, limited in-situ studies are available.

### Growth Processes of Microbes

Microbes, essential in bio-cementation, require a carbon source, energy, and a controlled environment for growth and survival. Different physiological groups of microorganisms operate under aerobic, anaerobic, and facultative conditions, influencing carbonate precipitation. The bacterial growth curve encompasses lag, log, stationary, and decline phases. (CarlosRodriguez-Navarro et. Al,2003)

### Bio-mineralization

Biologically-induced mineralization, common in open environments, is linked to microbial cell surface structures and metabolic activities. Extracellular polymeric substances (EPS) play a significant role in calcium binding and precipitation. Urealytic bacteria, which hydrolyze urea to create ammonia and carbonate ions, are often utilized for calcium carbonate precipitation. This metabolic activity increases environmental alkalinity, facilitating mineralization. (DhamiN, et al., 2013a)

### MICROORGANISM USED IN CALCITE PRECIPITATION

MICP, a process involving the biomineralization of calcium carbonate by bacteria, is a promising technique for soil improvement. This method, known as "Bio-Cementation," involves the secretion of calcite by naturally occurring soil bacteria. It has potential applications in biotechnology, geotechnology, and paleobiology. Unlike traditional methods, MICP significantly reduces energy consumption and emissions. The study aims to investigate the effects of various factors, including bacterial concentration, cementation concentration, temperature, and pH, on soil properties. (Al-Thawadi,S.M.2011). Various microorganisms have been reported to induce carbonate mineral formation. Common bacteria involved include cyanobacteria, sulfate-reducing bacteria, *Bacillus*, *Myxococcus*, *Halobacteria*, and *Pseudomonas*. *Sporosarcina pasteurii*, known for its high urease activity, is often used due to its capacity to precipitate large amounts of calcium carbonate quickly. (Bao,R.,et al., 2017)

### CONTROL PARAMETERS OF MICROBIALLY INDUCED CaCO<sub>3</sub> PRECIPITATION: BACTERIA:

Several factors influence the effectiveness of MICP:

- **Bacteria:** *Sporosarcina pasteurii*, with a high urease activity, is favored. A bacterial concentration of  $1 \times 10^6$  to  $1 \times 10^8$  cells is necessary for substantial CaCO<sub>3</sub> precipitation. (Gautam,S 2011).
- **Soil Condition:** Soil pore size, particle size, and shape impact MICP. Sand or soil should be washed to remove salts and contaminants. (Choi,S.G.,et al(2017).
- **Cementation Solution:** A higher concentration of Urea-CaCl<sub>2</sub> solution enhances MICP efficiency.
- **PH:** An alkaline or weak basic environment is ideal for CaCO<sub>3</sub> precipitation. (Kim, G., Kim, J., &Youn, 2018)
- **Temperature:** An effective temperature range is between 20°C and 37°C. (Kim, J., &Youn, H. (2018).
- **Urease and Its Activity:** Urease activity, not biomass concentration, influences precipitation. (BraissantO., 2007)

### Application of Biomineralization / Biocementing

#### Field Trials and Upscaling:

Researchers have conducted field trials and upscaling studies to validate the efficiency of Microbially Induced Calcium Carbonate Precipitation (MICP) for in-situ biocementation. (AnantAishwaryaDubey,(2021). They treated





Karthikeyan Vijayan et al.,

soil ranging from 1 m<sup>3</sup> to 100 m<sup>3</sup> with MICP and observed a significant increase in the strength of bio-cemented sand. However, there were challenges related to non-homogeneous CaCO<sub>3</sub> distribution, the amount and method of supplying reagents, and reagent flow. The cost of implementing MICP in the field remains relatively high. (VanPaassen, 2009)

**System Dependability:** MICP treatment offers system dependability and adaptability. It can be adjusted both mechanically and biologically to suit specific soil types and conditions. The treatment duration and uniformity can be customized, and biological activities can enhance spatial uniformity. This adaptability makes MICP suitable for various soil improvement applications, including construction site retrofitting (Achal & Mukherjee, 2015)

**Promoting Sustainability:** MICP's use of natural materials, particularly microorganisms, for cementing promotes sustainability in soil bio-cementation. (Gomez M Getal, 2017) MICP is a green technology widely used in construction, emphasizing its strategic role in sustainability. While urea hydrolysis produces ammonia, which can be hazardous to groundwater, proper planning and procedures can convert this by-product into a useful fertilizer. (Chaparro-Acuña, 2018) Over time, the CaCO<sub>3</sub> linkages between soil particles have no adverse effects on the subsurface conditions of bio-cemented soils. Soil compatibility, treatment uniformity, and the release of ammonia are factors that affect microbially induced calcium precipitation (DeJongetal., 2011).

## MATERIALS AND METHODOLOGY

Media preparation Gram / Litre

Calcium carbonate precipitation media (CCP) – Table 01

UREASE ACTIVITY ASSAY (QUALITATIVE) Table 02

CALCIUM CARBONATE SOLUBILIZATION TEST Table 03

### SAMPLING OF BIOCEMENT PRODUCING BACTERIA

The sample was suspended in a sterilized saline solution (0.85% NaCl), diluted appropriately and plated on calcium carbonate precipitation media (CCP). The plates were then incubated for 7 days at 28°C, and the colonies formed were examined under a microscope. Individual colonies were selected based on their visible crystal formation and pure colonies were isolated by streaking on calcium carbonate precipitation media without CaCl<sub>2</sub> (Wei et al., 2015).

### UREASE ACTIVITY ASSAY (QUANTITATIVE)

To assess urease activity, 1 mL of bacterial broth culture was mixed with 9.0 mL of 1.11 M urea solution and incubated at 20°C. After 5 minutes of incubation, the conductivity was measured using an electric conductivity meter. The rate of conductivity rise in mS/min indicated urease activity. (Mihai Andrei 2022) A graph was generated using conductivity values (ms/cm) over time, and the rate of conductivity change (ms/cm/min) was calculated by multiplying the graph's slope by the dilution factor. The specific urease activity (mM urea hydrolyzed/min/OD) was then determined by dividing urease activity by the bacterial biomass OD<sub>600</sub>, measured using a spectrophotometer. (Hammad et al., 2013).

### GRAM STAINING

Gram staining was performed to study bacterial morphology. Bacterial colonies were heat-fixed on glass slides, stained with crystal violet, followed by Gram's iodine. Decolorization was carried out, and counterstaining was done with safranin. Gram-negative bacteria appeared pink/red, while Gram-positive bacteria appeared blue/purple. (Smith & Hussey, 2005).

### BIOCHEMICAL TESTS

Several biochemical tests were conducted, including the indole production test, Methyl Red (MR) test, Voges-Proskauer (VP) test, citrate utilization test, oxidase test, and urease test.



**Karthikeyan Vijayan et al.,****Indole production test**

Bacterial isolates were incubated in indole production medium (tryptone broth) and examined for a pink or red color, indicating a positive result. (MacWilliams, 2012).

**Methyl Red (MR) test**

Bacterial isolates were cultured in MR-VP medium, and the appearance of a red color indicated a positive MR test.

**Vogesproskauer (VP) test**

Bacterial isolates were incubated in MR-VP medium, and a cherry red color within 1 hour indicated a positive VP test. (Abdallah et al., 2016).

**Citrate utilization test**

Bacterial isolates were inoculated in Simmons citrate agar, and the development of a deep blue color indicated a positive reaction. (Cheesbrough, 2005).

**Oxidase test**

This test involved the addition of  $\alpha$ -naphthol and p-aminodimethylaniline oxalate to bacterial cultures. A color change to blue (or purple within 2-3 minutes) indicated oxidase positivity. (Shields & Cathcart, 2010).

**Urease test**

Urea broth was prepared, and the change in color to yellowish-orange or pink after incubation indicated a positive urease test. (Brink, 2010)

**MOLECULAR CHARACTERIZATION****DNA ISOLATION**

To isolate DNA, the log-phase bacterial culture was centrifuged, and the pellet was resuspended in RNase. Lysozyme was added and incubated at 37°C for 60 minutes. Then, 10% SDS and proteinase K were added, and the tubes were incubated at 50°C for 60 minutes. A Phenol: Chloroform: Isoamyl (PCI) solution was added, mixed, and centrifuged. The aqueous phase was collected, and ethanol was added to precipitate the DNA. After centrifugation, the DNA pellet was resuspended in TE buffer. DNA presence and concentration were confirmed by agarose gel electrophoresis. (Dessy Ariyanti, 2011)

**SEQUENCING AND ANALYSIS:**

Universal primers 27F and 1492R were used for PCR amplification. The PCR mixture contained template DNA, forward and reverse primers, Master mix, and DNase-free water. PCR conditions included denaturation, cycles of temperature, and a final extension. The amplified product was sequenced, and the nucleotide sequences were analyzed and aligned using the CLUSTAL W program (BioEdit). A similarity search was conducted using BLAST in the NCBI GenBank database. A phylogenetic tree was constructed using the Neighbor-joining method (MEGA version 7) with a bootstrap value of 1000 replicates. (Wright et al., 2017).

**Calcium carbonate recovery**

Bacteria were cultivated aerobically in 100 mL of liquid calcium carbonate precipitation media in 500 mL Erlenmeyer flasks at 28°C for 60 hours. After incubation, the culture was centrifuged at 8500 rpm for 1 minute. (Anbu P, et al., 2016). The resulting pellet, containing calcium carbonate precipitate and bacterial cells, was resuspended in half volume of TE buffer. Lysozyme was added, and the cell suspension was incubated at 37°C for 1 hour to digest the bacterial cell wall. After removing cell debris by centrifugation, the pellet was washed with sterile distilled water (pH 8.5) and air-dried at 37°C for 24 hours. The pellet's weight was measured to estimate the amount of carbonate crystal precipitation. (Maroof et al., 2021).

**CHARACTERIZATION**

The carbonate crystals were characterized using SEM and EDX analysis. (Eman H. et. Al, 2021).



**Karthikeyan Vijayan et al.,****SEM and EDX ANALYSIS**

Microbially induced calcium precipitation (biocement-carbonate crystals) was analyzed with a scanning electron microscope (SEM). The microstructures of gold-coated soil specimens were examined using a Hitachi S4800 electron microscope operating at 200 kV, equipped with an energy dispersive X-ray (EDX) detector to detail surface composition. The physical and crystallization properties were analyzed.

**GC-MS**

Gas Chromatograph-Mass Spectrometry (GC-MS) was used for chemical analysis. A gas chromatograph equipped with a column and mass spectrometer was employed. The sample was injected and analyzed following a specific temperature program. Mass spectra were acquired to identify and characterize the compounds.

**RESULT****SAMPLING AND MICROBIAL PLATING**

Soil samples were collected from an industrial site, with two samples labeled A and B, taken from different locations. The collected soil samples were serially diluted up to  $10^{-5}$ , resulting in A1-A5 and B1-B5 dilutions. The fifth dilution ( $10^{-5}$ ) was chosen for bacterial culturing. (Braissant, O., 2007) The soil samples from the serial dilutions were observed for colony growth and morphological distinctions to assess the number of isolates in each soil sample.

**PURE COLONY ISOLATION:**

Isolates from the soil samples were characterized based on their colony morphology. Morphologically distinct isolates were individually cultured on Nutrient Agar plates. Two distinct colonies were selected from each of the two soil samples, labeled A51 and B51. (Anitha, V., et. Al, (2018).

**SCREENING OF UREOLYTIC BACTERIA:**

Ureolytic bacteria were identified based on their specific urease activity, measured as urea hydrolyzed per minute per optical density (OD). Urease activity was analyzed using the conductivity method. A51 exhibited the highest urease activity (883981.88 urea hydrolyzed  $\text{min}^{-1} \text{OD}^{-1}$ ) compared to B51 (326569.9038 urea hydrolyzed  $\text{min}^{-1} \text{OD}^{-1}$ ). Therefore, A51 was chosen as the isolate with high urease activity. The ability to produce urease is common among many soil bacteria, making it applicable for various soil bioengineering and environmental bioremediation purposes. (Burbank et al., 2012).

**GRAM STAINING**

The initial morphological identification of isolate was determined using gram staining method. A51 was classified as Gram positive strain as crystal violet stain was retained by thick peptidoglycan layer. A51 was determined to be rod-like shape in nature. Bacteria when rods in shape are called Bacilli. Figure 5.3 represents the gram staining of selected isolate, A 51

**BIOCHEMICAL CHARACTERIZATION**

A51 was positive for Methylred, Oxidase and Urease but negative for Indole, Citrate, Voges-Proskauer. Table 4 and Figure 5.4 represent the biochemical analysis of selected isolate A51. (GatD, et al., 2016)

**SEQUENCE ANALYSIS**

The 16S rRNA sequence of A51 was subjected to BLAST analysis in NCBI to identify the phylogenetic tree of the organism. *Sporosarcina pasteurii*'s phylogenetic tree was created using the neighbor-joining method. (Kou H, et. al, 2020).



**Karthikeyan Vijayan et al.,**

In order to stimulate ureolysis, the organisms were grown in tryptone soy broth with 4% urea solution added. After that, the organisms were injected into the mixture used to make biocement in order to precipitate calcium carbonate. (DhamiNK. 2014a)

## OPTIMIZATION OF CULTURE MEDIUM

### Stimulating Ureolysis and Biocement Production

The organisms were grown in tryptone soy broth with a 4% urea solution to stimulate ureolysis. Afterward, the organisms were introduced into the biocement mixture to precipitate calcium carbonate. Various factors were considered, including reaction time, inoculum size, urea content, and calcium chloride molarity. Media were sterilized before exposure to UV light. (Armstrong, et al., 2016)

### Specific Urease Activity

The specific urease activity of *Sporosarcina pasteurii* was calculated and tabulated in Table 8. The study found that *Sporosarcina pasteurii* could produce up to 6.7 g/l of CaCO<sub>3</sub> when 7cultivated in a medium containing urea. (Armstrong, et al., 2017)

### Effect of Different Parameters:

Among the parameters tested, it was found that A1 (1 mM calcium chloride and 2% urea,  $1.5 \times 10^8$  CFU) showed the highest specific urease activity. B4 (8% urea and 1 mM calcium chloride,  $1.5 \times 10^8$  CFU) exhibited the maximum specific urease activity among different urea concentrations. C3 ( $6.0 \times 10^8$  CFU, 1mM calcium chloride, 2% urea) displayed the highest activity among changes in bacterial concentration. D3 (120 hours of reaction time, 1mM calcium chloride, 2% urea,  $1.5 \times 10^8$  CFU) had the highest specific urease activity among various reaction times. These results indicate that changes in inoculum size significantly affected urease activity. (M.AzizulMoqsud2021)

### Calcium Carbonate Yield

The yield of calcium carbonate was influenced by calcium chloride molarity, urea concentration, inoculum size, and incubation period. Maximum yield of 125 mg was obtained with a change in calcium chloride concentration (1mM). The calcium carbonate yield remained relatively stable as calcium molarity increased. (Dupraz S., 2009) The highest calcium carbonate production of 530 mg occurred with an 8% urea concentration. It was observed that calcium carbonate production increased with increasing urea concentration. However, the carbonate output increased rapidly and then declined with higher inoculum size. The maximum yield was achieved with C3 ( $6.0 \times 10^8$  CFU). The yield also increased with longer incubation periods, with 120 hours of incubation resulting in a yield of 150 mg of calcium carbonate. Further increases in incubation time led to decreased yields. (Al-Thawadi, S.M. 2011)

## BIOCEMENT RECOVERY

### CHARACTERIZATION

#### SEM ANALYSIS

SEM was used to examine the size and shape of calcium carbonate crystals. *Sporosarcina pasteurii* formed CaCO<sub>3</sub> crystals, as seen in Fig.5.11. The average particle size of the calcium carbonate crystals, which have an irregular and spherical form, and the size was determined to be  $32 \pm 0.95$ . This outcome demonstrated that calcite made up the majority of the crystal. The formation, development and shape of crystal phases are all influenced by variables such as urea hydrolysis rate, calcium concentration, and urea concentration (DeMuynck et al., 2013; Whiffin, 2004).

#### EDX ANALYSIS

The chemical components of the sample were represented using EDX. Elements in a sample were identified by their atomic number and their concentration was calculated based on their peak intensity. Calcium, oxygen, carbon and other impurities made up the chemical makeup of precipitated crystals, which allowed scientists to determine the elemental ratio of pure calcium carbonate. Since the sample mostly contains calcium, oxygen and carbon, the







**Karthikeyan Vijayan et al.,**

precipitate was identified as calcium carbonate; Fig.5.12 illustrates the chemical makeup of crystals. CaCO<sub>3</sub> bio precipitation clogging pores and cracks in samples caused a reduction in water absorption (Seifanetal.,2019).

## CONCLUSION

Microbial induced calcium carbonate precipitation (MICP) offers an environmentally friendly approach to enhance soil stability. The study involved collecting soil samples from an industrial site and isolating the ureolytic bacterium *Sporosarcina pasteurii*, referred to as isolate A51. This bacterium displayed a high urease activity, leading to significant calcium carbonate precipitation. The study optimized various parameters, including calcium chloride concentration, urea concentration, inoculum size, and reaction time. Notably, an 8% urea concentration resulted in the highest specific urease activity and calcium carbonate yield. Furthermore, inoculum size played a significant role, with an optimal range for both urease activity and calcium carbonate precipitation.

Characterization of the calcium carbonate precipitate revealed irregular and spherical calcite crystals. Chemical analysis confirmed the predominant presence of calcium, oxygen, and carbon in the precipitate, confirming its composition as calcium carbonate. Overall, these findings demonstrate the potential of MICP for soil improvement, with applications in construction engineering and soil strength testing in the near future.

## REFERENCES

1. Abdallah,M.S.,Mustapha,T.,Gambo,A.,Ishaq,S.(2016).Biochemical identification and cultural characterization of some Gram-negative bacteria obtained from fecal/Diarrhoeal samples. *Cibtech Journal of Microbiology An Online International Journal*, 5, 17–24.
2. Achal,V.,&Mukherjee,A.(2015).A Review Of Microbial precipitation for sustainable construction. *Construction and BuildingMaterials*,93, 1224–1235.
3. Al-Thawadi,S.M.(2011).Ureolytic Bacteria And Calcium Carbonate formation mechanism strength enhancement of sand.J.*Adv. Sci.Eng.Res*,1(1), 98–114.
4. AnantAishwaryaDubey,K.Ravi,Mandeep K.Dhami(2021)Bio Mediated by native microbes from Brahmaputra River bank for mitigation of soil erodibility.
5. AnbuP,KangCH,ShinYJ,andSoJS(2016).Formation Of Calcium carbonate minerals by bacteria and multiple applications.
6. Anitha,V.,Abinaya,K.,Prakash,S.,SeshagiriRao,A.,&Vanavil, B. (2018). Bacillus cereus KLUVAA mediated biocement production usinghardwaterandurea.*ChemicalandBiochemical EngineeringQuarterly*,32(2), 257–266.
7. Armstrong, Ighodalo, Omoregie(2016) Characterization of ureolytic bacteria isolated from limestone caves ofSarawakand evaluation of their efficiency biocementation.
8. Armstrong,Omoriegie, Enzo.Palumbo,PeterM.Nissom(2017).Bioprecipitationof calcium carbonate mediated by ureolysis.
9. Bang,S.S.,Galinat,J.K.,N Ramakrishnan,V.(2001).Calcite precipitation induced by polyurethane-immobilizedBacillus pasteurii.*EnzymeandMicrobialTechnology*, 28(4–5), 404–409.
10. BanksEDTaylor,NMGulleyJ,LubbersBR.,Giarrizzo,JG Bullen, HAetal(2010). Bacterial Calcium Carbonate precipitation cave environments:a function of calcium homeostasis.
11. Bao,R., Li,J.,Chen, L.(2017) Effect Of microbial induced calcite precipitation on surface erosion andscourofgranularsoils proof of concept.
12. BernardiD,DeJongJT,MontoyaBM,andMartinezBC(2014).Bio bricks biologically cemented sandstone bricks.
13. BraissantO, DechoW, DuprazC, GlunkC, PrzekopKM., and VisscherPT. (2007). Exopolymeric Substances Of Sulfate Reducing bacteria: interactions with calcium alkaline pH an implication for formation of carbonate minerals.
14. Braissant,O.,Decho,A.W.,Dupraz,C.,Glunk,C.,Przekop,K.M.,&Visscher,P.T.(2007).Exopolymericsubstances of sulfate-reducing bacteria:interactions withcalciumatalkalinepHand implicationforformationofcarbonate minerals.*Geobiology*,5(4),401–411.





**Karthikeyan Vijayan et al.,**

15. Burbank MB, Weaver TJ, Williams BC and Crawford RL., (2012). Urease activity of ureolytic bacteria isolated from soils in which calcite was precipitated by indigenous bacteria.
16. Burbank, M.B., Weaver, T. J., Williams, B.C., Crawford, R. L. (2012). Urease Activity Of Ureolytic Bacteria isolated from soils in which calcite was precipitated by indigenous bacteria. *Geomicrobiology Journal*, 29(4), 389–395.
17. Carlos Rodriguez-Navarro, Manuel Rodriguez-Gallego, Koutar Ben Chekroun, and Maria Teresa Gonzalez-Munouz (2003). Conversion of Ornamental Stone by *Myxococcus xanthus*– Induced Carbonate Biomineralization.
18. Chaparro-Acuña, S.P., Becerra-Jiménez, M. L., Martínez-Zambrano, J.J., & Rojas-Sarmiento, H.A. (2018). Soil Bacteria That precipitated calcium carbonate: mechanism and applications of the process. *Acta Agronómica*, 67(2), 277–288.
19. Cheesbrough, M. (2005). *District Laboratory practice in tropical countries, part 2*. Cambridge University Press.
20. Cheng I, Cord-Ruwisch R, and Shahin, M. A. (2013). Cementation of sand soil by microbial induced calcite precipitation at various degrees of saturation.
21. Cheng, L., Shahin, M.A., Cord-Ruwisch, R. (2014). Bio-cementation of sandy soil using microbially induced carbonate precipitation for marine environments. *Géotechnique*, 64(12), 1010–1013.
22. Choi, S., Park, S., Park, M., Kim, Y., Lee, K.M., Lee, O.-M., & Son, H.-J. (2021). Characterization of Novel CaCO<sub>3</sub>-Forming Alkali-Tolerant *Rhodococcus erythrus* S26 as a Filling Agent For Repairing Concrete Cracks.
23. Choi, S.G., Park, S.S., Wu, C.H. (2017). Methods For Calcium carbonate content measurement of biocement soils.
24. Choi, S.-G., Wang, K., & Chu, J. (2016). Properties Of Cemented, fiber reinforced and. *Construction and Building Materials*, 120, 623–629.
25. Clara Saracho A Haigh S.K, and Ehsan Jorjat M. Flumes study on the effects of microbially induced calcium carbonate precipitation on the erosion behavior of fine sand.
26. Dawood Muhammed Iqbal, Leong Sing Wong, Si Ying Kong (2021) Biocementation Construction Materials.
27. De Muynck, W., Verbeken, K., De Belie, N., & Verstraete, W. (2010). Influence of urea and calcium dosage on the effectiveness of bacterially induced carbonate precipitation limestone. *Ecological Engineering*, 36(2), 99–111.
28. De Muynck, W., Verbeken, K., De Belie, N., & Verstraete, (2013). Influence of temperature on the effectiveness of a biogenic carbonate surface treatment for limestone conservation. *Applied Microbiology and Biotechnology*, 97(3), 1335–1347.
29. De Jong, J. T., Soga, K., Banwart, S. A., Whalley, W. R., Ginn, T.
30. R., Nelson, D.C., Mortensen, B. M., Martinez, B. C., & Barkouki, T. (2011). Soil engineering in vivo: harnessing natural biogeochemical systems for sustainable, multi-functional engineering solutions. *Journal of the Royal Society Interface*, 8(54), 1–15.
31. Dessy Ariyanti, Noer Abyor Handayani, Hadi Hadiyanto (2011). An Overview Of biocement production from microalgae.
32. Dhama N, Reddy M, Mukherjee (2013a). *Bacillus megaterium* mediated mineralization calcium carbonate was biogenics surface treatment green building materials.
33. Dhama N, Reddy M, and Mukherjee A (2013b). Biomineralization Of calcium carbonate and their engineering applications.
34. Dhama N K., Reddy M S., and Mukherjee A (2014a). Application Of calcifying bacteria for remediation of stones and cultural heritage.
35. Dupraz, Reid R P., Braissant O., Decho W., Norman R S., and Visscher P T., (2009). Processes of carbonate precipitation in microbial mats.
36. Dupraz S., Parmentier M, Menez B, and Guyot F (2009). Experimental and numerical modeling of bacterially induced pH increase and calcite precipitation in saline aquifers.
37. Dupraz, C., Visscher, P. T., Baumgartner, L. K., Reid, R. P. (2004). Microbe--mineral interactions: early carbonate precipitation in a hypersaline lake (Eleuthera Island, Bahamas). *Sedimentology*, 51(4), 745–765.
38. Iman, Zaghoul, Hassan A L. Ibrahim, Dalia E I S. El-Badan (2021). Production of biocement with Marine Bacteria: *Staphylococcus epidermidis* EDH to enhance clay water retention capacity.
39. Ercole C, Bozzelli P, Eltner, C., and Del Gallo M (2012). Calcium Carbonate mineralization: involvement of extracellular polymeric materials isolated from calcifying bacteria.
40. Ercole C., Cacchio P, Botta A., Centi V., and Lepidi A., (2007). Bacterially Induced Mineralization Of Calcium Carbonate: thereof exopolysaccharide and capsular polysaccharides.
41. Gat D, Ronen Z and Tsesarky M (2016). Soil bacteria population dynamics following stimulation for ureolytic microbial induced CaCO<sub>3</sub> precipitation.





**Karthikeyan Vijayan et al.,**

42. Gautam,S.P.,Bundela,P.S.,Pandey,A.K.,Khan,J.,Awasthi,M.K.,Sarsaiya,S. (2011). Optimization For the production of cellulase enzyme from municipal solid waste residue by two novel cellulolytic fungi.*BiotechnologyResearchInternational*,2011.
43. Gomez M.G, GraddyC.M.R, DeJongJ.T, Nelson D.C. Biogeochemical Changes during biocementation mediated by stimulated and augmented ureolytic microorganisms.
44. GomezMGetal.(2017). Large scale comparison of bioaugmentation and biostimulation approaches for biocementation of sands.
45. Gomez, M.G., Anderson, C.M.,Graddy,C.M.R., Dejong, J.T., Nelson, D.C.,Ginn, T.R.(2017) Large scale comparison of bioaugmentation and biostimulation approaches for bio sands.
46. Kim, G., Kim, J., &Youn, H. (2018). Effect Of Temperature, pH, and reaction duration microbially induced calcite precipitation. *AppliedSciences*,8(8),1277.
47. Kou H,WuC,NiP andJangB (2020). Assessment of erosion resistance of biocementedsandyslopesubjectedtowave actions.
48. LeiWang,JiangXiang,XiangHe,JianChu(2021)Crackling Noise andbio-cementation.
49. M.AzizulMoqsud(2021)Slope soil stabilization through biocementation by native bacteria inChugokuregion,Japan.
50. Mihai Andrei(2022).New Sustainable, cheap,and renewable biocement is made from sludge and urine.

**Table 1. Calcium carbonate precipitation media (CCP)**

Chemicals	Quantity
Urea	20g
NaHCO <sub>3</sub>	2.12g
NH <sub>4</sub> Cl	10g
Nutrient broth	3g
30mM CaCl <sub>2</sub>	3g
Agar	20g
pH maintained at 8.5	

**Table 2 UREASE ACTIVITY ASSAY (QUALITATIVE)**

Chemicals	Quantity
Pancreatic digest gelatin	1g
Dextrose	1g
Sodium chloride	5g
Monosodium phosphate	2g
Urea	20g
Phenol red	12g
Agar	15g
pH was adjusted to 6.	

**Table 3 CALCIUM CARBONATE SOLUBILIZATION TEST**

Chemicals	Quantity
Yeast Extract	0.5 g
Dextrose	10 g
CaCl <sub>2</sub>	5 g
Ca <sub>3</sub> (PO <sub>4</sub> ) <sub>2</sub>	0.5 g
(NH <sub>4</sub> ) <sub>2</sub> SO <sub>4</sub>	0.5 g
KCl	0.2 g





**Karthikeyan Vijayan et al.,**

MgSO <sub>4</sub>	0.1 g
MnSO <sub>4</sub>	0.0001 g
FeSO <sub>4</sub>	0.0001 g
Agar	20 g

**Table 4 Biochemical Analysis of Selected Isolate**

S.NO	BIOCHEMICAL TEST	RESULT IN FERENCE OF A51
1	MethylRed	Positive
2	Indole	Negative
3	Citrate	Negative
4	Voges-Proskauer	Negative
5	Oxidase	Positive
6	Urease	Positive

**Table 5 Optimization of Different Parameters**

Tube No.	Calcium Chloride- Molarity	Urea- Concentration	Inoculum Size	Reaction Time
A1	1mM	2%	1.5x10 <sup>8</sup> CFU	72Hours
A2	2mM	2%	1.5x10 <sup>8</sup> CFU	72Hours
A3	3mM	2%	1.5x10 <sup>8</sup> CFU	72Hours
A4	4mM	2%	1.5x10 <sup>8</sup> CFU	72Hours
B1	1mM	2%	1.5x10 <sup>8</sup> CFU	72Hours
B2	1mM	4%	1.5x10 <sup>8</sup> CFU	72Hours
B3	1mM	6%	1.5x10 <sup>8</sup> CFU	72Hours
B4	1mM	8%	1.5x10 <sup>8</sup> CFU	72Hours
C1	1mM	2%	1.5x10 <sup>8</sup> CFU	72Hours
C2	1mM	2%	3.0x10 <sup>8</sup> CFU	72Hours
C3	1mM	2%	6.0x10 <sup>8</sup> CFU	72Hours
C4	1mM	2%	9.0x10 <sup>8</sup> CFU	72Hours
D1	1Mm	2%	1.5x10 <sup>8</sup> CFU	72Hours
D2	1mM	2%	1.5x10 <sup>8</sup> CFU	96Hours
D3	1Mm	2%	1.5x10 <sup>8</sup> CFU	120Hours
D4	1Mm	2%	1.5x10 <sup>8</sup> CFU	144Hours





Karthikeyan Vijayan et al.,

Tube No.	Calcium Chloride–Molarity	Urea–Concentration	Inoculum Size	Reaction Time
A1	1mM	2%	$1.5 \times 10^8$ CFU	72Hours
A2	2mM	2%	$1.5 \times 10^8$ CFU	72Hours
A3	3mM	2%	$1.5 \times 10^8$ CFU	72Hours
A4	4mM	2%	$1.5 \times 10^8$ CFU	72Hours
B1	1mM	2%	$1.5 \times 10^8$ CFU	72Hours
B2	1mM	4%	$1.5 \times 10^8$ CFU	72Hours
B3	1mM	6%	$1.5 \times 10^8$ CFU	72Hours
B4	1mM	8%	$1.5 \times 10^8$ CFU	72Hours
C1	1mM	2%	$1.5 \times 10^8$ CFU	72Hours
C2	1mM	2%	$3.0 \times 10^8$ CFU	72Hours
C3	1mM	2%	$6.0 \times 10^8$ CFU	72Hours
C4	1mM	2%	$9.0 \times 10^8$ CFU	72Hours
D1	1Mm	2%	$1.5 \times 10^8$ CFU	72Hours
D2	1mM	2%	$1.5 \times 10^8$ CFU	96Hours
D3	1Mm	2%	$1.5 \times 10^8$ CFU	120Hours
D4	1Mm	2%	$1.5 \times 10^8$ CFU	144Hours

Table 7 Specific Urease Activity of *Sporosarcina pasteurii*

FLASK NO.	UREASE ACTIVITY	SPECIFICUREASE ACTIVITY
<b>Calcium Carbonate Molarity</b>		
A1	19887.668	8.234157850
A2	15202.915	5.131977876
A3	15095.713	6.84197684
A4	12293.030	4.872461793
<b>Urea Concentration</b>		
B1	21300.748	1.47167312
B2	15876.105	2.24758395
B3	15422.298	1.44133869
B4	70930.225	73.39819278
<b>Inoculum Size</b>		
C1	15685.583	9.17986556
C2	11506.083	11.39278706





**Karthikeyan Vijayan et al.,**

C3	21714.810	14.26749032
C4	15787.360	8.42554797
<b>Incubation Time</b>		
D1	18100.148	1.67274385
D2	13502.333	1.98844180
<b>D3</b>	<b>18697.395</b>	<b>1.75478471</b>
D4	14245.748	1.25219769

**Table 8 Calcium Carbonate Yield of *Sporosarcina pasteurii***

Tube No.	Calcium Chloride – Molarity	Urea – Concentration	Inoculum Size	Incubation time	Calcium carbonate yield
A1	1 mM	2 %	$1.5 \times 10^8$ CFU	72 Hours	125
A2	2 mM	2 %	$1.5 \times 10^8$ CFU	72 Hours	92
A3	3 mM	2 %	$1.5 \times 10^8$ CFU	72 Hours	76
A4	4 mM	2 %	$1.5 \times 10^8$ CFU	72 Hours	59
B1	1 mM	2 %	$1.5 \times 10^8$ CFU	72 Hours	90
B2	1 mM	4 %	$1.5 \times 10^8$ CFU	72 Hours	100
B3	1 mM	6 %	$1.5 \times 10^8$ CFU	72 Hours	270
<b>B4</b>	<b>1 mM</b>	<b>8 %</b>	<b><math>1.5 \times 10^8</math>CFU</b>	<b>72 Hours</b>	<b>530</b>
C1	1 mM	2 %	$1.5 \times 10^8$ CFU	72 Hours	60
C2	1 mM	2 %	$3.0 \times 10^8$ CFU	72 Hours	90
<b>C3</b>	<b>1 mM</b>	<b>2 %</b>	<b><math>6.0 \times 10^8</math>CFU</b>	<b>72 Hours</b>	<b>280</b>
C4	1 mM	2 %	$9.0 \times 10^8$ CFU	72 Hours	113
D1	1 mM	2 %	$1.5 \times 10^8$ CFU	72 Hours	121
D2	1 mM	2 %	$1.5 \times 10^8$ CFU	96 Hours	127
<b>D3</b>	<b>1 mM</b>	<b>2 %</b>	<b><math>1.5 \times 10^8</math>CFU</b>	<b>120 Hours</b>	<b>150</b>
D4	1 mM	2 %	$1.5 \times 10^8$ CFU	144 Hours	74

